

## MO-MNP3 Crystal Projector Speaker Nightlight 星空投射燈藍牙喇叭

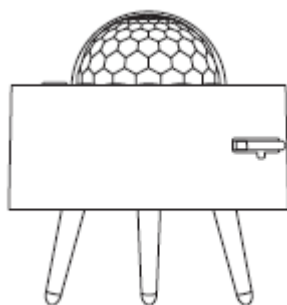

### 特點

- 星空投射燈藍牙喇叭，同時支援夜燈和音樂功能
- 15種夜燈色彩模式，在不同環境中營造各種氣氛
- 夜燈有12段亮度控制和3種旋轉功能
- 夜燈自動轉換顏色，營造夢幻氛圍
- 有星光模式和9個星球模式，營造生動美麗的太空環境
- 有音樂感應模式，夜燈可與音樂配合
- 有自然聲效，感覺放鬆
- 遙控器簡便操作
- 可用計時器設置方便使用
- 穩定的無線連接長達10米，便捷的Type-C電源

### Features

- Projector speaker nightlight that supports functions of both nightlight and music simultaneously
- 15 color modes of nightlight that create various mood in different environment
- Nightlight with 12-level brightness control and 3-level rotation
- Automatic color conversion of nightlight creating dreamlike atmosphere
- Starlight mode & 9 planet modes creating vivid and beautiful space environment
- Music sensor mode enables the nightlight to react to the music
- Nature sounds that provide rest and sense of stability
- Easy operation with remote control
- Convenient use by timer setting
- Stable wireless connection up to 10m and convenient type-C power

### 組件

- 主體
- 支撐 x 3個
- 投影機幻燈片 x 3個
- 遙控器
- Type-C USB 電線(2A)
- 手冊

### Components

- Main body
- Support x 3ea
- Projector slide x 3ea
- Remote control
- Type-C USB cable(2A)
- Manual

## 規格

- 藍牙版本: 藍牙 5.0V
- 藍牙範圍: 10米  
\* 藍牙範圍可能因使用環境和是否有物體而有所不同。
- 藍牙頻率: 2.402~2.480GHz
- 藍牙配置文件: HFP, HSP, A2DP, AVRCP
- 輸出功率: 3W
- 揚聲器阻抗: 4Ω
- 頻率響應: 20Hz-20KHz
- 額定電壓: DC 5V 2A
- 功耗: 最大7W
- 音量: ≥80 dB

## Specification

- Bluetooth Version: Bluetooth 5.0V
- Bluetooth Range: 10m \* Bluetooth range can vary depending on using environment and whether there is object or not.
- Bluetooth Frequency: 2.402~2.480GHz
- Bluetooth Profiles: HFP, HSP, A2DP, AVRCP
- Output power: 3W
- Speaker Impedance: 4Ω
- Frequency Response: 20Hz-20KHz
- Rated Voltage: DC 5V 2A
- Power Consumption: Max. 7W
- SN Ratio: ≥80 dB

## [ 產品詳情 Product Details]

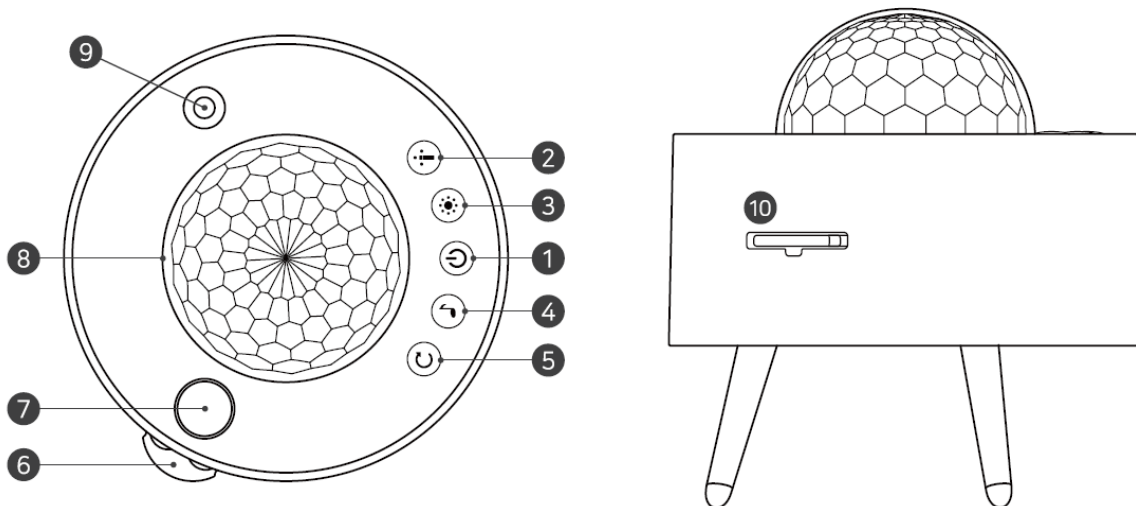

1. Power button 開關按鈕
2. Planet mode/Starlight mode ON/OFF, Disconnection button for wireless speaker 星球模式/星光模式 開/關, 無線喇叭中斷
  - a. Short press: Planet mode/Starlight mode ON/OFF 短按: 星球模式/星光模式 開/關
  - b. Long press: Disconnection button for wireless speaker 長按: 無線喇叭中斷
3. Switch nightlight color mode and brightness control 切換夜燈顏色和亮度控制
  - a. Short press: Switch nightlight color mode 短按: 切換夜燈顏色
  - b. Long press: Brightness control 長按: 亮度控制
4. Button for white noise/wireless speaker mode change, music sensor and volume control 白噪音/無線喇叭切換, 音樂感應器和音量控制
  - a. Short press: white noise/wireless speaker mode change 短按: 白噪音/無線喇叭切換
  - b. Long press: Volume control 長按: 音量控制
  - c. Music sensor ON/OFF while using wireless speaker 在使用無線喇叭時的音樂感應器 開/關
5. Nightlight rotation/stop and speed control 夜燈旋轉/停止和速度控制
6. Projector slide 投影片
7. Projector 投影機
8. Nightlight 夜燈
9. Starlight laser 星光激光
10. Projector slide slot 投影片插槽

- a) Power ON/OFF 電源開/關
- b) Music sensor 音樂感應
- c) Timer setting (30 minutes, 1 hour, 1 hour 30 minutes) 計時設定 (30分鐘, 1小時, 1小時30分鐘)
- d) Volume control 音量控制
- e) Play previous track/Next track 播放上/下一個音樂
- f) White noise/wireless speaker mode change 白噪聲/無線喇叭切換
- g) Timer OFF 計時器關閉
- h) Planet mode/starlight mode ON simultaneously 星球模式/星光模式同時開啟
- i) Planet mode ON 星球模式開啟
- j) Starlight mode ON 星光模式開啟
- k) Nightlight rotation speed control & stop 夜燈旋轉速度控制和停止
- l) Nightlight brightness control 夜燈亮度控制
- m) Nightlight color change 夜燈顏色變換
- n) Automatic color conversion mode 自動顏色切換

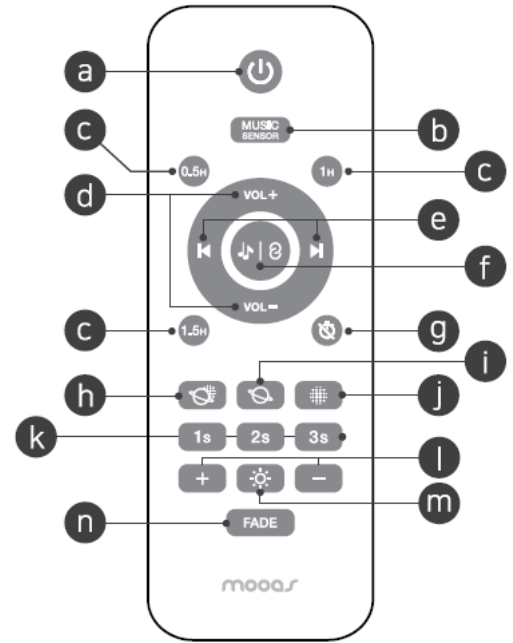

## 【使用方法How to use】

### 組裝

#### 1) 支架組裝

- ① 準備主體和3個支撐件。
- ② 將每個支撐件插入主體底部的溝槽中。請將支撐件插入成外向的對角線狀。
- ③ 順時針旋轉支撐件以固定位置。
- ④ 對其他2個支撐件進行相同操作。

#### 2) 如何使用星球投影片

- ① 在3個附帶投影片中，選擇所需的星球投影片。
- ② 將投影片底部朝下，正確插入槽中。
- ③ 旋轉投影片以改變星球的圖案。

## Assembling



### 1. Assembling of support

- Prepare the main body and 3 pieces of support.
- Insert each support into the groove on the bottom of main body. Please insert the support so that they form a diagonal line outwards.
- Turn the support clockwise to fix it.
- Do the same for other 2 supports.



### 2. How to use planet slide

- Among 3 included slides, choose the desired planet slide.
- Once making the bottom part of slide face down, insert it properly into the groove.
- Turn the slide to change the planet pattern.

## 電源開/關

將Type-C USB電線連接到主體底部的電源口上。按下機上  按鈕或遙控器上的  按鈕來開/關電源。預設是夜燈藍色(速度等級1)/星球模式開啟/星光模式開啟。



## Power ON/OFF

Connect the included type-C USB cable to the power port on the bottom of the main body. Press  button of the main body or  button of the remote control to turn on/off the power. The default setting is as follows.

Nightlight blue (Speed level 1) / Planet mode ON / Starlight mode ON

## 極光夜燈

### 1. 更改顏色



按主機上的  按鈕或遙控器上的  按鈕來在15個顏色中改變夜燈的顏色。變化順序如下：  
順序：藍->紅->綠->白->藍/紅->藍/白->藍/綠->紅/綠->紅/白->綠/白->藍/紅/綠->藍/綠/白->藍/紅/白->藍/紅/綠/白->自動顏色轉換模式->夜燈關閉->重複自動顏色轉換模式是夜燈顏色逐漸自動變化的模式。

在使用主體上的按鈕時，按上述順序操作。在使用遙控器時，使用漸變按鈕來切換。

### 2. 亮度控制



長按主體上的  按鈕或遙控器上的  按鈕來控制夜燈的亮度，共12個級別。

### 3. 旋轉速度控制

按主機上的  按鈕或遙控器上的  按鈕來調整夜燈的旋轉速度。使用遙控器時，按下當前級別的按鈕(->當前速度)來停止旋轉。在使用主機上的按鈕時，操作順序如下：  
主機上的旋轉按鈕操作順序：級別1->級別2->級別3->停止->重複

## Aurora Nightlight

### 1. Color change

- Press  button on the main body or  button on the remote control to change nightlight color in 15 modes. The sequence of change is as follows.
- Sequence: Blue -> Red -> Green -> White -> Blue/Red -> Blue/White -> Blue/Green -> Red/Green -> Red/White -> Green/White -> Blue/Red/Green -> Blue/Green/White -> Blue/Red/White -> Blue/Red/Green/white -> Auto color conversion mode -> Nightlight OFF -> Repeat
- Auto color conversion mode is the mode in which the nightlight color changes gradually and automatically. It operates in the above sequence when using the button on the main body. When using the remote control, use the Fade button to switch.

### 2. Brightness control

- Long press  button on the main body or  button on the remote control to control brightness of nightlight in 12 levels.





### 3. Rotation speed control

- Press  button on the main body or  button on the remote control to adjust rotation





speed of the nightlight. When using the remote control, press the current level button (-> current speed) to stop the rotation. When using the button on the main body, the operating sequence is as follows.

- Operating sequence of rotation button on the main body: Level 1 -> Level 2 -> Level 3 -> Stop -> Repeat

## 星球模式/星光模式

1. 按主體上的  按鈕或遙控器上的    按鈕來打開/關閉星球模式和星光模式。使用主體上的按鈕時，操作順序如下。  
順序：星球模式/星光模式開啟 -> 星光模式開啟(行星模式關閉) -> 星球模式開啟(星光模式關閉) -> 星球模式/星光模式關閉 -> 重複
2. 使用遙控器上的按鈕時，按鈕操作如下。

## Planet mode / Starlight mode

1. Press  button on the main body or    button on the remote control to turn on/off the planet mode and starlight mode. When using the button on the main body, operating sequence is as follows.
  - a. Sequence: Planet mode/Starlight mode ON -> Starlight mode ON (Planet mode OFF) -> Planet mode ON (Starlight mode OFF) -> Planet mode/Starlight mode OFF -> Repeat
2. When using the button on the remote control, the button operates as follows.



: Planet mode + Starlight mode ON/OFF 星球模式 + 星光模式 開/關



: Planet mode: ON/OFF 星球模式: 開/關





: Starlight mode: ON/OFF 星光模式: 開/關



## 白噪音/無線喇叭

按主體上的  按鈕或遙控器上的  按鈕，切換到白噪音或無線喇叭模式。



## White noise/Wireless speaker

Press  button on the main body or  button on the remote control to switch to white noise or wireless speaker mode.

## 機上按鈕

1. 在使用主體上的  按鈕時，按鈕的操作如下。
  - 短按  按鈕可更改音效。  
順序：蟲鳴聲 → 水聲 → 浪聲 → 無線喇叭 → 重複
  - 長按  按鈕進行音量控制。



## Button on the main body

1. When using the  button on the main body, the button operates as follows.
  - Short press  button to change sounds.

- Sequence: Bug sound -> Water sound -> Wave sound -> Wireless speaker -> Repeat
- Long  press button for volume control.





2. 使用遙控器時，按鈕的操作如下所示。

2. When using the remote control, the button operates as follows.

-  Mode change: (White noise ↔ Wireless speaker) Default setting of white noise: Bug sound  
模式更改：(白噪音 ↔ 無線喇叭) 白噪音的預設：蟲鳴聲
-  Sound change in white noise mode (Sequence: Bug sound, Water sound, Wave sound) / Go to previous track or next track in wireless speaker mode  
白噪音模式中的音效變化(順序：蟲聲、水聲、波浪聲)/ 在無線喇叭模式下切換至上或下一個曲目
-  Volume control 音量控制





## 無線喇叭

只需在首次連接時進行配對，以後就會自動連接。當無法進行自動配對時，請重新從頭開始進行配對。

1. 設備配對：選擇無線喇叭後，在支援藍牙的設備中啟用藍牙功能。搜索可連接的設備並選擇「Mooas MNP3」。完成配對後，設備和喇叭會有提示音說明連接成功。
2. 切換到下一首或上一首曲目：可按遙控器上的  按鈕或使用已連接的設備進行切換。
3. 音量控制：可按遙控器上的  按鈕或使用已連接的設備進行音量控制。
4. 音樂感應：當播放音樂時，可按遙控器上的  按鈕或  按鈕來關閉/開啟音樂感應。  
\*音樂感應是指夜燈會根據音樂自動閃爍和變換顏色的功能。
5. 斷開配對的設備：如果您長按主機上的  按鈕，配對的設備會斷開並發出聲音提示「已斷開連接」。如果您想再次連接設備，請重新進行配對。

## Wireless speaker

Pairing only once on the first connection guarantees automatic connection afterwards. When automatic pairing is not available, please perform the pairing again from the beginning.





1. Device pairing: Once wireless speaker mode is selected, activate the Bluetooth function in Bluetooth enabled device. Search for the connectable device and select 'Mooas MNP3'. When pairing is completed, the device and speaker will be connected together with a ringtone.
2. Moving to another track: Move to previous or next track with  button on the remote control or by using connected device.
3. Volume control: Control the volume with  button on the remote control or by using connected device.
4. Music sensor: Turn off/on the music sensor while music is playing by pressing  button or  button on the remote control.

\* Music sensor is the function in which the nightlight blinks and change color automatically according to music.

5. Disconnection of paired device: If you long press  button of the main body, the paired device will be disconnected with the voice "Disconnected". Please perform pairing again from the beginning if you want to connect the device again.



## 計時器

在使用計時器時，當設定的時間結束時，所有操作會停止。

- 1) 可以使用遙控器上的    按鈕來設定計時器。按鈕的操作如下:(如下表)
- 2) 按下遙控器上的  按鈕以取消計時器。
- 3) 為了安全使用，使用4小時後，電源將自動關閉。

## Timer

When the timer function is used, all operation stops when the set time has been finished.

- 1) The timer can be set using    button on the remote control. The button operates as follows.

 : 30-minute timer 30分鐘計時器

 : 1-hour timer 1小時計時器

 : 1 hour 30 minute timer 1小時30分鐘計時器

- 2) Press  button on the remote control to cancel the timer.

- 3) For safe use, the power is automatically turned off after 4 hours of use.

## 【注意事項】

- 請勿將夜燈和投影機直接照射到眼睛上，可能會對眼睛造成損害。
- 若附近有很多藍牙設備，可能會有頻率干擾。請勿讓本產品受到其他設備的干擾。
- 設備間的距離為10公尺。若超出範圍，連接將自動斷開。
- 請勿存放在高溫、高濕、陽光直射、潮濕或塵埃的地方。
- 請勿使用化學產品清潔本產品。清潔異物或灰塵時，使用軟布或毛巾進行清潔。
- 請僅使用附送的Type-C USB傳輸線。
- 請勿拆卸、修理或修改本產品。
- 請勿對本產品施加強烈的震擊。
- 為避免損壞，請勿在不穩定或傾斜的地區使用本產品。
- 本產品不是玩具。兒童需在成人監督下使用本產品。
- 在存放期間請將本產品放在兒童無法觸及的地方。

## [Precaution]

- Do not shine the nightlight and projector to the eyes. It may cause damage in the eyes.
- If there are many Bluetooth devices in the vicinity, there may be a frequency crossing. Please do not let

the product be disturbed by other devices.

- The distance between devices is 10m. If out of range, the connection is automatically disconnected.
- Do not store in a place with high temperature and high humidity, direct sunlight, humidity or dusty place.
- Do not clean the product with chemical products. Use a soft cloth or towel when cleaning foreign objects or dust.
- Please use the included type-C USB cable only.
- Do not disassemble, repair or modify the product.
- Do not apply strong shock to the product.
- Do not use the product in unstable or tilted areas in order to prevent damage.
- The product is not a toy. Children must use the product under supervision.
- Keep out of reach of children during storage.

組件:主體、支撐架 x 3 個、投影片 x 3 張、遙控器、Type-C USB 線 (2A)、說明書

尺寸:φ132 毫米 x 138 毫米(直徑 x 高度)

重量:338 克(不包括遙控器/Type-C USB線)

線長度:1.2 米

材質:ABS、PP、矽膠

額定輸入:直流 5V 2A

功耗:最大 7W

電源:Type-C USB 線

操作溫度:-20~40°C

製造日期:另行標註 / 中國製造

※該無線裝置可能會造成無線電干擾, 因此不提供與人身安全相關的服務。

Components: Main body, Support x 3ea, Projector slide x 3ea, Remote control, Type-C USB cable(2A), manual

Size: φ132 mm X 138 mm (D X H)

Weight: 338g (Excluding remote control/cable)

Cable Length: 1.2m

Material: ABS, PP, Silicone

Rated Input: DC 5V 2A

Power Consumption: Max. 7W

Power: Type-C USB cable

Operating Temperature: -20~40°C

MFG Date: Marked separately / Made in China

※This wireless device may cause radio interference, so service related to human life safety is not provided.