

Osaki

Massage Chair

OS-Monarch

User's Manual

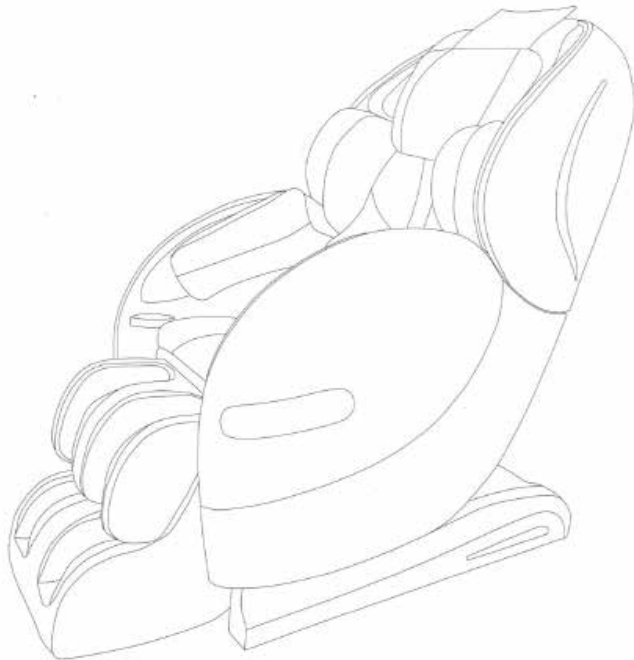

Please read SAFETY INSTRUCTIONS carefully before using the chair.

Osaki OS-Monarch Introduction

1. The Monarch uses a patented low noise, ultra-thin 3-D massage mechanism. This allows for a kneading, rocking, tapping, and shiatsu massage styles which mimic a professional massage therapist.
2. The automatic body scanning is used for precise detection of the user's height allowing for people of varying heights to use the chair.
3. One button zero gravity function that can effectively alleviate pressure on the spine and joints.
4. The forward sliding design means that the backrest and seat move together and can take full advantage of the allowable space. It is recommended to keep the chair about 1 inch away from the wall.
5. The footrest is equipped with foot rollers and air bags to stimulate the soles of the feet. There are also sets of airbags located on the calves providing a comprehensive leg and foot massage that helps to promote good blood circulation.
6. The footrest also allows for up to 12.5 inches of extension to allow for users of different heights to use the chair.
7. The air bags located on the arm provide a gentle massage to promote healthy blood circulation as well.
8. The easy to use full-color LCD remote shows the position of the rollers and the massage intensity, speed, and strength levels.
9. Equipped with Bluetooth speakers, the chair can be paired with any Bluetooth capable device to play music.
10. Mild lumbar heating helps to loosen sore muscles and promote blood circulation.
11. The USB port located on the inside of the right armrest can be used to charge your devices.
12. USB socket inside the right armrest can be used for emergent charging.

- ✦ 1.Thank you for choosing the Massage Chair OS-Monarch.
- 2.Please read this manual carefully before using the massage chair.
- 3.Please keep this manual in a safe place for further reference.
- 4.Please pay attention to SAFETY INSTRUCTIONS.

✦ Note: We reserve the right for design modification. It is subject to change without notice. The pictures in this manual are only for reference. Please refer to the actual product.

Content

Preparation	Safety instructions	1
	External structure parts	5
	Internal structure parts	6
	Mechanical components diagram	7
	Mechanical components list	8
Installation	Installation	9
Massage Operation	The adjustment before massage	15
	Manual control	17
	Operation instruction &function illustration	21
	After massage	23
Maintenance	Care and maintenance	24
Others	TROUBLE SHOOTING guide	25
	Technical data	26

Please keep this manual in a safe place for future reference.

1

Safety instructions

- ✦ ● Please read this manual carefully to make sure the installation and operation of the massage chair is correct.
- ✦ ● "Safety Instructions" is provided as both a Warning and Caution for important safety information.

Both Warning and Caution are important safety caution, please read carefully.

	Warning	This sign indicates warning of causing possible death or hurt to body.
	Caution	This sign indicates caution of causing possible hurt or damage to things.

Symbol meaning

	This sign indicates forbidden behavior.		This sign indicates self disassembly is forbidden.
	This sign indicates must follow instruction to operate.		This sign indicates correct operation of cable.

- ✦ ● The following should be kept for any further references.

Warning		
	<ul style="list-style-type: none"> ● People with osteoporosis, vertebral fractures, and acute painful diseases such as sprains or muscle strains. ● Heart disease patients (including those who have pacemakers or are using other medical electronics). ● Cancer patients. ● People with perceptual disorders due to high levels of peripheral circulatory disturbances such as diabetes. ● People with abnormal spine or crooked spine. ● People with Protruded intervertebral Disc. ● Pregnant women and those who have just completed childbirth, as well as people with poor health. ● People with trauma, such as thrombosis, acute varices, and various skin inflammations. ● People who have been identified as having lost their ability to discern temperature. ● People with high fever (acute inflammation: such as burnout, chills, blood pressure changes, physical weakness). ● Elderly people over 80. ● Persons with impaired consciousness, mentally handicapped persons, or those who are incapable of operating the unit are prohibited from using this unit. ● People who can not take care of themselves, infants. ● Do not use this unit when it is wet or when you are wet. ● Care must be taken by people who are sensitive or intolerant to heat. ● Do not fall asleep in this unit. <p>People with above symptoms should not use massage chair, or use it under doctor's advice. User's discretion is advised if use the chair.</p>	<p>Not suitable for these users</p> <p>Risk of causing accident or body discomfort.</p>

Preparation

Safety instructions



2

 Warning	
<ul style="list-style-type: none"> Before sitting, please confirm that there are not objects in the chair or in between airbags. When using the backrest, calf up & down, or calf extended, be sure to check that there are no people or objects in the area (behind, under, or in front of the chair). In the event of a physical abnormality or abnormality in use, stop using it immediately and ask a doctor. Massage around the head should pay attention to the movement of the massage rollers. Pay attention to massaging around the head; do not use a massage that is too strong or use for extended periods of time massage. Pay special attention when you massage the area around your neck. Avoid excessive neck massage. Do not massage the abdomen or knees with this machine. If you want to leave your seat during the massage, you must stop the massage chair before you leave the seat. Do not use it with other instruments. Do not allow children or pets to play on or around the unit (especially in use); nor can they sit or stand on backrests, armrests or legrest. When people who lack proper communication skills are using the massage chair, supervision and care must be paid. Before moving the unit, the backrest and legrest must be angled back to their original position. 	Accident/injury
<ul style="list-style-type: none"> When assembling, turn off the switch and unplug it after the chair returns to the upright position. Insert the plug of the chair into correct and suitable power socket. Make sure the plug is completely inserted into the socket to reduce short circuit or fire risk. Unplug the power when not in use, stop all massage functions and turn off on/off key before unplugging. 	Fire and electric shock
<ul style="list-style-type: none"> Massage cushions of the chair should not be folded for storage. The massage chair should not be left running without anyone in it for a long period of time. An appliance should never be left unattended when plugged in. Power cord, plug, and socket should not be used if broken or if the contact is loose. Don't use any other power source except the rated voltage to prevent fire, electrical shock or other malfunctions. Don't use any other power source except the rated voltage to prevent fire, electrical shock or other malfunctions. Never operate this appliance if it has a damaged cord, plug or if they are not working properly. Keep the cord away from heated surfaces. 	Accident Fire and electric shock
<ul style="list-style-type: none"> If the chair malfunctions, breaks, or becomes wet for any reason please contact an authorized repair technician. Self-modification, disassembly, or maintenance is not allowed and will void all warranties. If power cord or plug is damaged, please don't replace it yourself, please contact us or appointed dealer for replacement. To avoid electrical shock or personal injury, please don't open or disassemble any part of the chair, there is not any attached part of the chair for maintenance by customers. Check leather or cloth material on the back and other. If broken, even though it is small, please stop using the chair, unplug the power. Check leather or cloth material on the chair periodically to ensure that it is not ripped or torn. If a rip or tear is found, please contact an authorized repair technician to have it repaired. 	Disassembly and maintenance

Preparation

Safety instructions

3



 Caution	
<ul style="list-style-type: none"> Please operate the chair in a flat or level place. 	To avoid sudden falling.
<ul style="list-style-type: none"> The maximum suggested operating time is 20mins, 5mins for each position beginning with the slight-step massage. Along continuous massage in the same position may cause uncomfortable feeling. 	Using the chair for long periods of time can be bad for your body.
<ul style="list-style-type: none"> Before sitting on the chair to avoid injury please inspect everything to confirm that the massage heads are in the correct position. 	To avoid accidental injury.
<ul style="list-style-type: none"> Hand control should be timely put into the hand control bag, do not arbitrarily put away, to avoid squeezing or drop damage. 	To avoid accidents when turning on the power.
<ul style="list-style-type: none"> Please make sure that the power switch is at the "OFF" position before inserting the plug into the socket. 	To reduce short circuits and any fire hazard.
<ul style="list-style-type: none"> Turn off all controls before removing plug from outlet. 	To avoid accidents when turning on the power.
<ul style="list-style-type: none"> Make sure the plug completely insert into the socket. 	To reduce short circuits and any fire hazard.
<ul style="list-style-type: none"> Checking whether any damage on wire, make sure no water or rubbish on wire. 	To avoid electrical shock in case of water damage or malfunction.
<ul style="list-style-type: none"> Installing earth wire in correct way. The plug must be inserted into socket with earth connect, the earth connect couldn't be bend or cut off. 	To avoid electrical shock in case of water damage or malfunction.
<ul style="list-style-type: none"> Don't press with hands or step on the massage heads with feet. Don't put hands between the working massage heads. Don't put hands or feet in the gap of mechanical parts. Don't drop. Too long time massage is bad for your body. Using the chair for long periods of time can be bad for your body. Anything into the slot of massage chair. Don't stand or sit or put anything on the backrest, armrest or leg-rest. Don't move the chair during operation. Don't stand on the chair during operation. Don't pull out the plug or turn off the power during operation. Don't put your hands or head between leg-rest or beneath. Don't use the massage chair while wearing hair ornaments. Don't put hard things in pocket. To avoid the accident when turn on the power. To avoid accidents when turning on the power. Don't sit or press on the backrest when the chair is in reclining position. Don't use at bare skin or thin clothes. Do not use the massage chair on bare skin or wear thin clothes. Wearing thinner clothes may achieve a better effect during the massage but, it can also cause skin irritation. Do not use massager in close proximity to loose clothing or jewelry. Keep long hair away from massager while in use. Never operate the appliance with the air openings blocked. Keep the air openings free of lint, hair, and the like. Do not crush. Avoid sharp folds. 	To avoid accidents or injury
<ul style="list-style-type: none"> Keep the chair away from heat, wet, sharp things and corrosive, inflammable or flammable, explosive environment. The use of electric blankets or other heating products on the chair is not allowed. electric blanket or other heating products on the chair is forbidden. Keep the chair away from stove or other heating products. Don't put the chair directly under the sun or other high temperature places. Do not place the chair in a dusty or corrosive environment. Do not place the chair in a small space or in an area with poor air circulation. 	To avoid fade, discolor on upholstery or hardened, deteriorated on PU, TPU. To avoid fading, discoloration, hardening or deterioration of the PU.
<ul style="list-style-type: none"> Don't use the chair outdoor. 	

Preparation

Safety instructions

4

Caution

	<ul style="list-style-type: none"> Keep dry. Do not store the chair in a wet environment such as: near a pool or bathroom, swimming pool, or bathroom. Keep the chair and remote control dry all the time. Do not use it when user's body is wet. 	To avoid water damage or electrical shock
	<ul style="list-style-type: none"> Make sure to install the earth wire in correct way (Incorrect install way may cause electric shock. If you don't know how to install, please find a professional electrician) Don't use plug adapter (If the enclosed plug doesn't match with socket, please don't change the plug by yourself and find a professional electrician to install a matched socket.) 	To avoid electric shock.
	<ul style="list-style-type: none"> Unplug the power before cleaning the chair. Unplug the power after using the chair. Unplug the power when any damage (Unplug the power cord when you notice any damage to the cord or plug.) unplug the power but not try to pull the wire to unplug the power. 	To avoid electric shock or fire hazard.
	<ul style="list-style-type: none"> Please turn off the power switch and unplug the power after massage. 	To avoid accidents
	<ul style="list-style-type: none"> Unplug the power immediately when electricity goes off. 	To avoid any damage or accidental injury when turning the power on again.

Preparation

Grounding instruction

- ※ The chair is equipped with a cord having a grounding conductor. The plug must be plugged into an appropriate socket that is properly installed and matched with the plug.



Replace fuse

- ※ Open the lid covering the fuse, which is located on the switch box.
- Earth Wire is not allowed to be in these places:

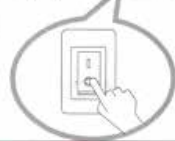

 Earth wire is not allowed to be in these places

Gas pipe: probably cause explosion or fire.
Phone wire and lightning rod: probably cause electric shock and fire when thundering.
Water pipe: earth wire is useless where there are plastics

5

External structure parts

External structure

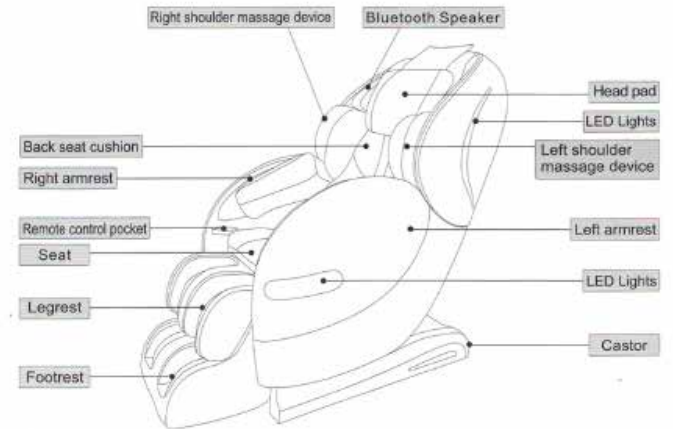

Preparation

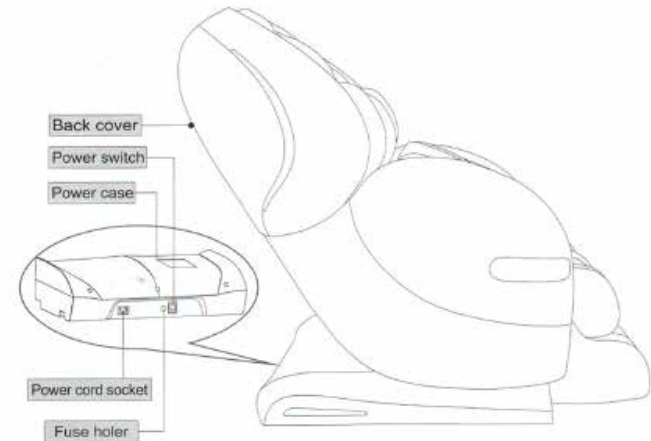

Internal structure parts

6

Internal structure

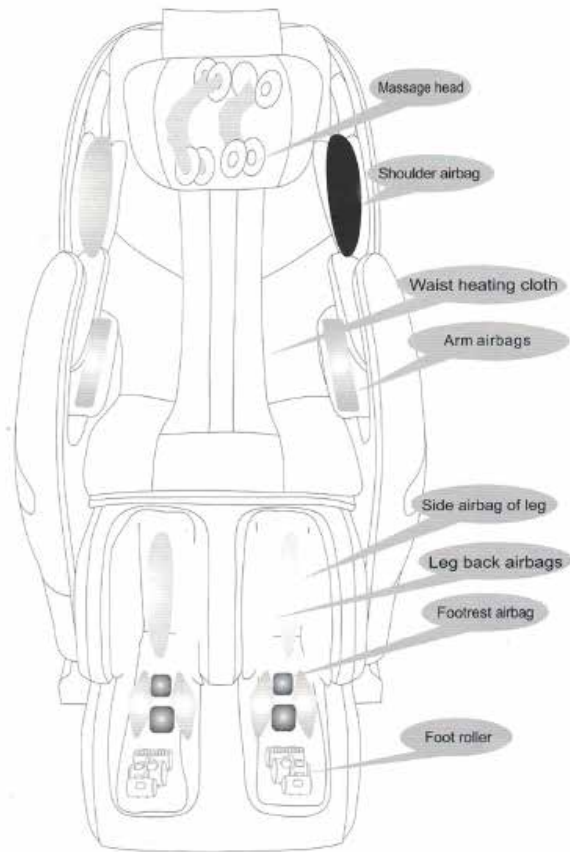

Preparation

Mechanical components diagram

7

Explosion Diagram

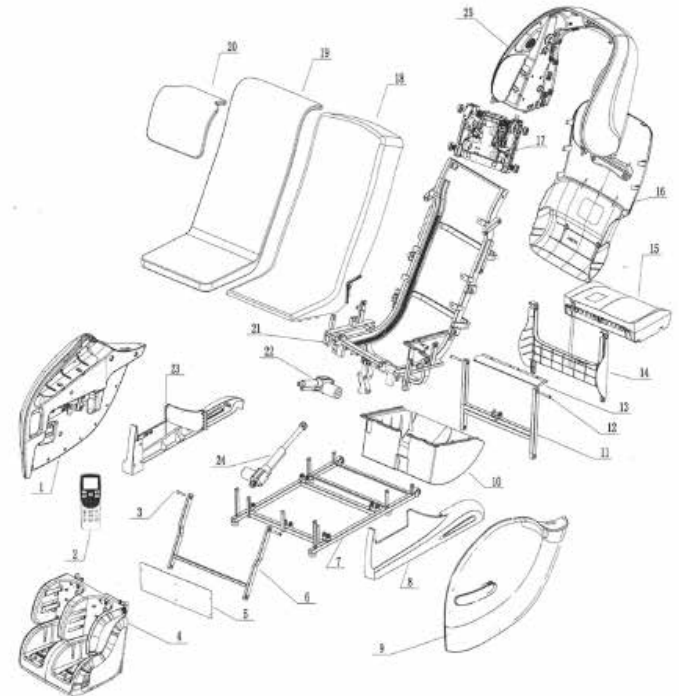

Preparation

Mechanical components list 8

Mechanical components list

NO.	Name	Q'ty	NO.	Name	Q'ty
1	Right armrest assembly	1	22	Leg electric actuator	1
2	Remote control	1	23	Right side fender	1
3	Back bolt	2	24	Back electric actuator	1
4	Foot and leg assembly	1	25	Shoulder assembly	1
5	Front fender	1			
6	Front swing assembly	1			
7	Bottom frame assembly	1			
8	Left side fender	1			
9	Left armrest assembly	1			
10	Front protective cover	1			
11	Back swing assembly	1			
12	Back bolt	1			
13	Back fender 2	1			
14	Back fender 1	1			
15	Power case assembly	1			
16	Back cover	1			
17	Massage machine	1			
18	Backrest	1			
19	Back seat cushion	1			
20	Pillow	1			
21	Back frame assembly	1			

Preparation

9 Installation

Installation (1)

Step 1. Take out the main body and accessories from the lifting from box.

- ① Take out the accessories boxes and the main chair from the lifting from box by at least three people.
- Confirm all the accessories.

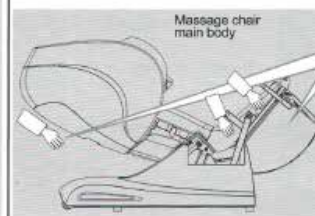

Message chair main body

Two people grasp left and right seat metal frame, the other one catch handling position of the back cover, then take the main body of massage chair out of the box.

The accessories



Head pad



Electric power cable



Remote control



Back seat cushion

- ③ Take out the left, right armrest from the armrest box, put the armrest on the table or ground flat (pay attention to prevent scratches)



Left armrest



Right armrest

- ④ Taking out the legrest device from the legrest box, the left and right two sides of the legrest and take them out.

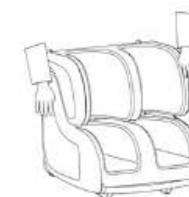

Legrest device

Installation

Installation (2)

● Check environment

- Make sure there is adequate space

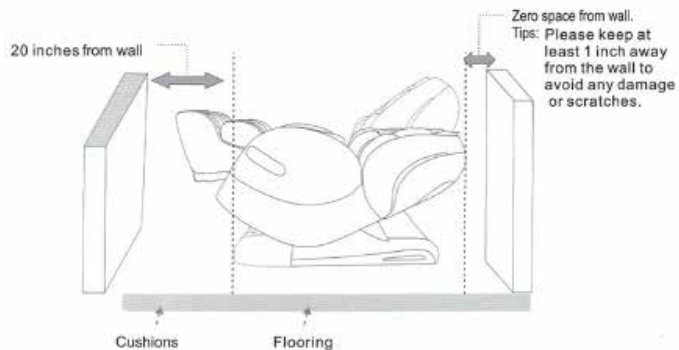

Because the chair is heavy, over time it may damage your flooring. It is recommended that you place a rug or another type of soft floor covering under the chair to avoid damage.

Installation

Installation (3)

Step 2. Assemble controller cable and massage chair return to normal

- 1 Connect the salient position on seat right side socket with controller plug recession position, fasten with nut.
- 2 Insert one end of cable to power box jack, the other end to the socket, turn on the switch on the power box, the massage chair is in powered status.
- 3 Press On/Off button, in controller, controller is in powered status, press On/Off again to turn off, the backrest goes up and seat goes down.
- 4 After the chair returns to upright position, switch off and plug off.

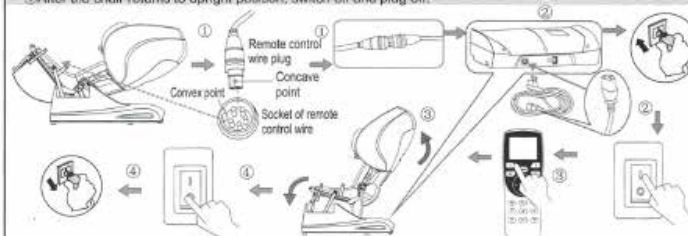

Step 3. Fix left armrest and right armrest.

- 1 The armrest is close to the side of main board.
 - 2 Insert the armrest limit plate into the side panel.
 - 3 Insert the square column on lower shoulder to the hole on rear armrest.
 - 4 Align the 2 fixed holes on armrest with fixed frame holes on frame side, fasten with 2 M8*40 screws and big gasket by hand, do not tighten.
 - 5 Open shoulder airbag zipper, align the hole on rear armrest upper position with iron plate hole on shoulder airbag lower position, fasten with 1 M5*25 screw and big gasket by Phillips screwdriver, before tightening, move armrest slightly, make the shoulder and armrest space uniform, tighten it, and zip it up.
 - 6 Tighten the M8*40 screw by hexagon wrench as showed in 3.
 - 7 Connect the air nozzle on the seat tube and connect the wire harness.
- Install the other armrest according to the above method.

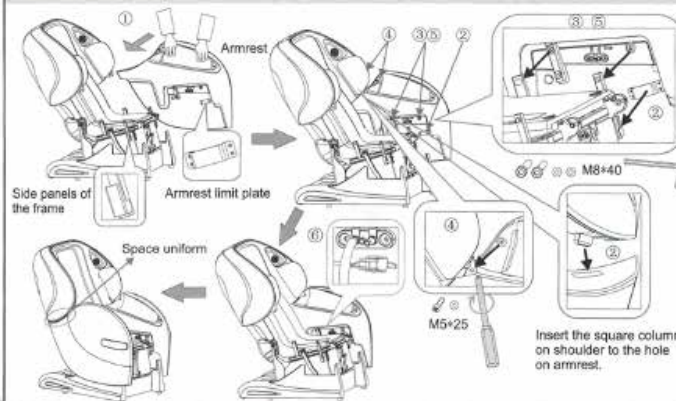

Installation

Installation (4)

Step 4. Fix the Leg-rest

① Put the rear of leg-rest near the seat front part. ② Plug off the pine leaf pin on the leg-rest rear connecting rod and pull the shaft and two shaft sleeves out from the connecting rod hole. ③ Raise the seat front connecting rod and insert those two shaft sleeves from the two sides of connecting rod hanger into the holes. ④ At the same time, lift the rear leg-rest connecting rod, align it with the hanger hole, insert the shaft into the hole and lift the other connecting rod and insert the shaft into the hole. ⑤ Plug the pine leaf pin in the small hole of shaft correctly. ⑥ Connect the air tubes of leg-rest with those of the chair body according to the same color in the right way tightly. From the left to the right. ⑦ Plug the power cord into the socket. ⑧ Remove the screw of the leg-rest hanger. ⑨ Lift up the hanger shaft pressing plate and raise the bottom of leg-rest higher as the photo shows and put the shaft into the chair body hanger, then lower down the shaft pressing plate. ⑩ Fix the screw tightly.

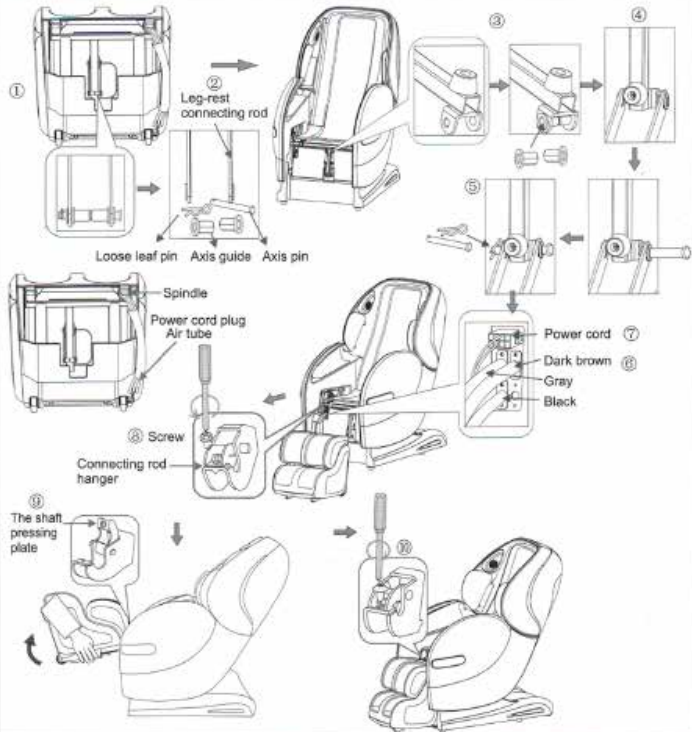

Installation (5)

Step 5. Controller placement

Put controller to armrest inside bag after the armrest installation is done.

Tips: 1. Put controller cable in seat side to prevent from squeezing.
2. Put controller cable on seat when installing the back seat cushion.

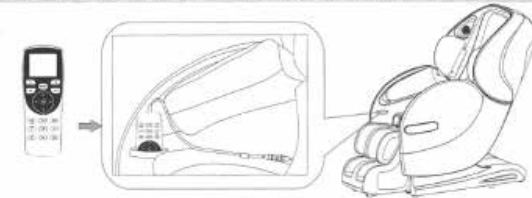

Step 6. Install heating line, back seat cushion and pillow

Put the heating line of back seat cushion and the line of the right side of the seat. Then connect back seat cushion, pillow and back.

★ Warm tips

In order to get exact correct body test data for comfortable massage effect, when you sit on the chair, please make the bottom rim of the head pad flush with your ears before zippering the said two parts.

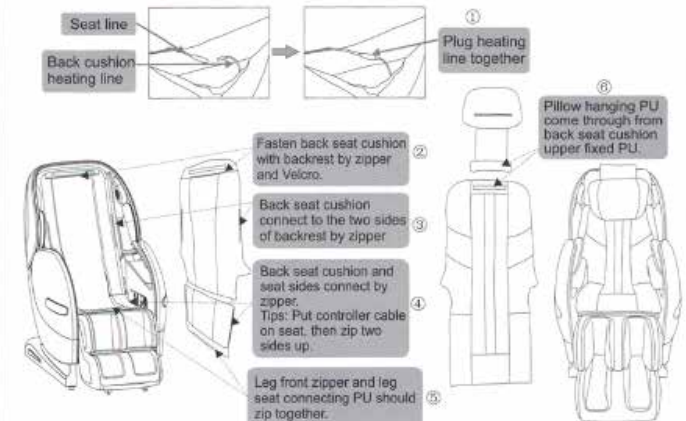

Installation (6)

Step 7. Restore the chair

- 1 Plug the cable line in the hole a on the power box as shown in the right picture.
- 2 Insert the plug of cable line into the socket.
- 3 Turn on the switch behind the power box. (Switch on/off "O/I", press I down to turn it on.)
- 4 Use the hand controller to choose massage functions, enjoy the relax and comfortable massage by our products.
- 5 In ON status, the USB port can be used for charging mobile. Do not move the mobile during charging.

! Make sure the switch is off before you insert the plug of cable line into the socket.

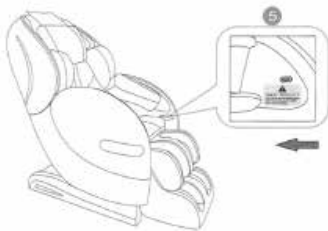
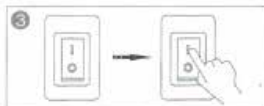
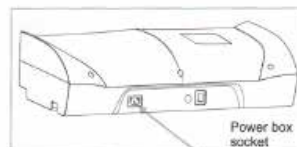

Installation

Environment

! Caution

- Don't use the chair in wet places like near swimming pool, bath room to avoid leakage or electric shock.
- Don't use under sunlight or near stove or other heating place to avoid upholstery deteriorated.
- !** Please use chair in flat place to avoid chair falling or noise or other unexpected trouble.

● Check places in front

Check the areas when back and leg extending, make sure no people, pets or other things around.



● Check power cable, plug

- (1) Clean the dust on plug on time. (using dry cloth).
- (2) No damage, re-do, bend, stretch, tie or press with heavy thing (especially can't be pressed by the chair) on power cable.

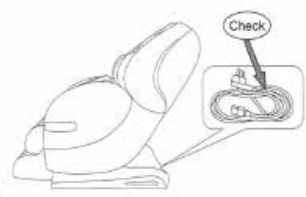

Check environment

● Space size for using the chair

- Zero space from wall. Tips: at least 1cm from wall.



- At least 50cm in front of the leg.

● Check surroundings

When the backrest or legrest reclines or extends, please pay attention to:

- (1) Check any person or things in every direction.
- (2) Check the space size.

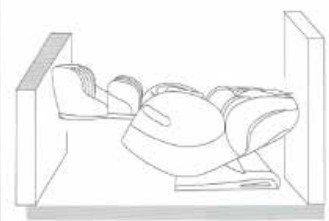
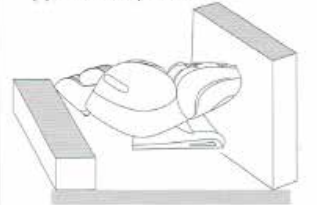

Massage operation

The adjustment before massage

16

How to move massage chair



Caution

- ✦ Don't move chair when it's working in case of accidents or damage

How to move

- ✦ Bind the cables and put them in the seat to avoid damage when moving.
- ✦ If you plump the chair, it may damage the inner parts of the chair.
- ✦ Don't use the castor if the floor is wooden or other easy damaged material. It will need 2 or more persons to lift the chair.
- ✦ Make sure the power is off and the plug doesn't touch the floor (It's better to let the chair in standing status to avoid the back crashing the floor)



Normally

- ① Press down the head part to make the gravity fall on the back castors. Then push the chair to desired destination steadily and set it down slowly.



Please hold the footrest to move the chair as shown in the picture in case any scratches on the leatherette

During massage chair backrest lie down process, can't move the armrest.

Adjustment before massage

Before adjustment

- ✦ Make sure the massage machine rollers stop in the upper of backrest, then sit on the chair slowly.



- ✦ To avoid injure caused by wrong position of the massage head.

- ✦ When doing Acupuncture Point Detecting, if the massage head can not find the shoulder position, it will default to the middle part.

Right position: Your back cling to the chair back, the head clings to the pillow.



The remote control will beep once the body scan starts working. When you hear that beep sound, you can press the up/down key on the control to manually adjust the shoulder position.

- ✦ Avoid a wrong detection of your shoulder position which will influence the massage comfort.

Kind suggestion

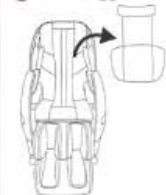

- ✦ If you feel the massage isn't strong enough, you can remove the pillow.

- ✦ Because the chair is heavy, it may ruin your floor in long time setting. Please put a blanket or other soft things to protect your floor.

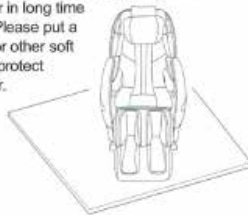

Massage operation

17

Manual control

Manual control



- On/Off
- Fast relax
- Menu
- Confirm button
- Left
- Air pressure
- Manual
- Legrest up
- Legrest down
- Fast Relax
- MENU
- OK
- Right
- Down
- Heating
- Heating
- Backrest up & legrest down
- Foot-roller button
- Legrest up & backrest down
- Zero-Gravity
- Pause
- Auto
- Up
- Right

Massage operation

Manual control 18



1. In standby mode, press ON/OFF key, the massage chair go into the ON status, then press Menu key or other key to choose any auto massage program, the massage machine will detect shoulder height and start to massage. In ON status, press the ON/OFF key, the massage chair will turn off and return to original status, the legrest goes down to the lowest position, the backrest raise up to the top, the controller turn off in 3-5 seconds.



2. In the boot state, press the button to enter the "fast relaxation" automatic massage program. Default work time is 8 minutes.



3. In the boot state, press the button to enter the "fast relaxation" automatic massage program. Default work time is 8 minutes.



4. Press this button in Main interface to switch to menu interface, user can set different function for massage chair. Press it in Menu interface to return to main interface.



5. In ON status, press this key each time to change one kind of auto program, there are the following programs for choice, "Recovery", "Pain relief", "Stretch", "Sleeping", "Experience" and "Stop" mode, there is relative status screen display.



6. There are four direction buttons: Up, Down, Left and Right, in the menu interface, it is used as navigation key; press Up and Down to quickly browse the menu, and press Left and Right key to go to previous and next menu. In manual mode, the Up and Down key can also be used to adjust massage roller position in body scanning and fixed point massage.



7. In ON status of menu mode, press this button for confirm to choose menu item or pop up at the next menu.



8. In ON status, press this key each time to change one kind of manual program, there are 5 massage methods for choice, "Kneading", "Knocking", "Tapping", "Kneading&knocking", "Shiatsu", there is relative status screen display.



9. In the boot state, press this key to select: full body, hand and shoulder, leg and footrest, stop.



10. In the boot state, press this button to control the heating switch.



11. Keep pressing this button, legrest goes up, release it, legrest stop moving. Controller screen will show position adjusting... when adjusting the position of massage chair.



12. In ON status, under programs with foot airbag massage, press it, to adjust foot roller speed, fast, slow and off recycles. Otherwise, choose foot airbag massage program, the roller is fast.



13. Keep pressing this button, backrest goes up, legrest goes down, release it, backrest and legrest stop moving. Controller screen will show position adjusting... when adjusting the position of massage chair.



14. Keep pressing this button, legrest goes down, release it, legrest stop moving. Controller screen will show position adjusting... when adjusting the position of massage chair.



15. In the boot state, press this button, the massage chair adjust into zero gravity status, press this button again, the massage chair reset into power-on status. The zero gravity icon of the main interface will display the current zero gravity state after the massage.



16. Keep pressing this button, backrest go down, legrest go up, release this button, backrest and legrest stop moving. When adjusting sitting position, it shows seat position adjusting... in controller screen.

18

Massage operation

19

Manual control

LCD display graphic description

Main interface



Press "on/off" button when power is on, a buzzer beeps once short and brittle. LCD screen display boot screen, after 2-3 seconds it displays the main interface and enter standby mode. Main interface show massage position, method, time, current massage status etc., all information will be updated timely when the chair start working.



Menu interface



Press the "menu" button in the main interface, it will switch to the menu interface, user can set all massage function. Press the "menu" button in the menu interface will exit and return to the main menu interface.

Auto Mode: Press Menu to select auto mode by pressing OK. Select from Recovery, Pain Relief, Stretch, Sleeping, Experience and Special. The Special auto mode includes four special massages, Athlete mode, Shopaholic, Neck & Shoulder and Back & Waist.

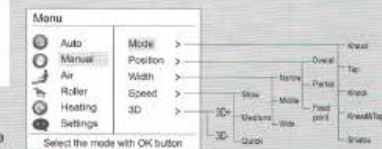

Manual Mode: Press Menu to select manual mode by pressing OK. It has five function settings including Mode, Position, Width, Speed and 3D. Select one function, then press OK to enter next menu, select the desired massage mode and position, adjust the width, speed and 3D intensity.

When massage chair in manual fixed point work mode, users can use up/down button to adjust massage position, information for "massage position adjusting..." will show at the bottom of the display screen.

Note:

1. When select the massage mode, the default position is whole, just do only one time body scan.
2. After shoulder height detection can adjust massage position, speed, width.

Massage operation

LCD display graphic description

Airbag: Press MENU button and select "air pressure" with the navigation key, then press the OK button, there are two kinds of air pressure functions: Position and Intensity. Choose the corresponding function, then press OK to go to the next menu and choose required function.

Menu
Auto
Manual
Air
Roller
Heating
Settings

Position >
Intensity >

Overall_Off
Upper_Off
Lower_Off

Weak
Medium
Powerful

Select the mode with OK button

- Note:**
1. During all auto massage settings, the default setting for the foot rollers is on. Press "Stop" under Roller to turn it off.
 2. Under Air, when selecting Overall or Lower, the foot roller is on. Press "Stop" under Roller to turn it off.
 3. In Air program, choose upper position, the foot roller is off.
 4. In programs without foot airbag massage, press it to turn on foot airbag massage program, the roller is fast.

Thermotherapy: Press the menu button, select the thermotherapy by navigation key, there are ways to adjust on and off. After turn on the thermotherapy function, the heating symbol of the main interface is highlighted, waist heating open.

Menu
Auto
Manual
Air
Roller
Heating
Settings

Start
Stop

Setting: Press "Menu" button, choose "Setting", then choose "Timer", "Language", "Stop".

Menu
Auto
Manual
Air
Roller
Heating
Settings

Timer >
Language >
Stop

10 min
20 min
30 min

简体中文
English
한국어

Select the mode with OK button

Timer: "10min", "20min", "30min" for choice; Default working time is 20mins. When time is up, the power be turned off automatically.

Language: Simplified Chinese, English, 한국어, for choice.

Stop: Press this button to stop all the massage program in progress.

After Power is on, the first time to use auto program, massage chair will start acupuncture point position detecting, and "acupuncture point tracking ..." will be shown on screen display. After acupuncture point tracking detecting is finished, buzzer will tick 5 times (once every second), meanwhile, the massage machine is located in shoulders position, if user think the position is not proper, press Up and Down to adjust, when adjusting, "acupuncture point adjusting ..." is showing on screen display. Default working time is 20 minutes. (Massage chair will turn off and return after the massage is over)

Auto-Fast relax 08 min

Speed: |||

Width: |||

Intensity: |||

30 min

Acupuncture point tracking ...

Massage operation

ON/OFF

Step1. Power on

- ① Put one end plug of power line to "a" hole.
- ② Put power plug to socket.
- ③ Turn on the power switch on the power box, massage chair powers on.
- ④ Press "ON/OFF" button on the remote which will beep once. It will then enter the display interface.

Step2. Massage

- ① Operate according to controller operation instructions. As for the massage method's details, please refer to remote control's Usage page.
- ② When the massage ends, massage machine will return to the default position, meanwhile "Shutting down" will be displayed on the controller.

Remote control

Step3. Turn off the power

- ① When the chair is On, press On/Off button to turn off the massage chair and it will restore automatically.
- ② Turn off the power switch on the bottom of the back of chair after the rollers reach storage position.
- ③ Unplug the power plug from the socket.

Warning

1. Before using, pull up the pillow, back cushion etc. to check if the PU material is broken, if there is damage, please stop using, unplug the chair, and ask for repairment.
2. Only plug to proper socket.

Massage operation

Function Illustration

● Legrest Up

Press this button on controller, legrest goes up. Release the button, legrest stops moving, the angle is locked in this position.



● Legrest Down

Press this button on controller, legrest goes down. Release the button, legrest stops moving, the angle is locked in this position.



● Legrest up and backrest down

Press this button on controller, backrest goes down and legrest goes up. Release this button, backrest and legrest stops moving, the angle is locked in this position.



● Backrest up and Legrest down

Press this button on controller, backrest goes up and legrest goes down. Release this button, backrest and legrest stops moving, the angle is locked in this position.



● Zero gravity

Press the button "Zero" to make the backrest go down and the footrest go up and put the chair into Zero Gravity mode. Pressing the button again will stop the backrest and footrest from moving locking the chair in that position.



● Legrest extend and retract

The leg and footrest can be extended automatically within the range of 9 inches, and the leg-rest can extend within 6 inches.



● Arm massage

The armrest has built-in pulse pressure massage function, put your arm in the air bag when it is not inflating. After the airbag is inflated, the arm and palm can be massaged, no matter how the seat changes, can always maintain a comfortable massage state on the arm.

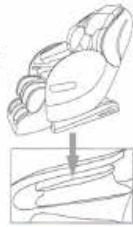

● Shoulder massage

Multilayer extrusion airbags are deployed on both sides of the shoulder. Which aids in a shoulder stretch massage to relieve shoulder fatigue.



● Foot massage function

The footrest has a rolling and airbag massage to stimulate the sole of the foot helping to relieve aches and promote blood circulation.



Massage operation

1. Please make sure there is no people, no pets or any stuff around the backrest to avoid unexpected hurt or property loss.
2. When adjusting the backrest, be careful of the gap between the backrest and armrest.
3. When the legrest is moving, please do not stand on or leave from the seat, do not stop the legrest from moving in case of causing damage to the chair.
4. Please refer to control instruction for more details.

Restoration of massage chair

1. Make sure there are no people or pet or anything within the range of backrest and legrest.



2. Make backrest and legrest restore to the normal position by controller, (or press ON/Off key to make backrest and legrest restore to the normal position)

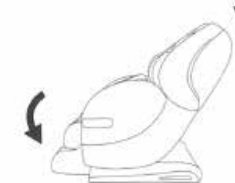

3. Put the controller back into the controller bag of the right armrest after the chair back to the initial position.



4. Switch off the power.

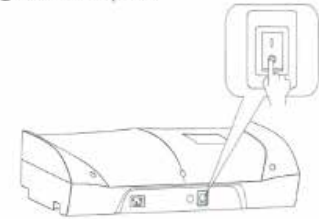

5. Unplug the electricity from the socket. (Attention: hold the right plug position)



6. Clean the chair if necessary.

Massage operation

Synthetic leather

● **General cleaning**

Clean with tidy, soft and dry cloth slightly.



Do not use the thinner, gasoline, alcohol or other chemical materials.



● **If leather is dirty**

- 1 Dip soft cloth into 3-5% neutral detergent solution, squeeze it then clean the stain on the surface gently.
- 2 Wash cloth, squeeze it and wipe with detergent.



- 3 Clean it softly with dry cloth.
- 4 Allow to dry (air blower is prohibited)

Cloth material

- 1 Dip cloth into weak neutral detergent, squeeze it and clean the material surface.

● Do not use the thinner, gasoline, alcohol or other chemical materials.

- 2 Brush the dirty parts with weak neutral detergent. (avoid excessive brushing)

⚠ Excessive cleaning may cause damage to cloth material.

- 3 Wipe with water-dipped but squeezed cloth.

- 4 Allow to dry.



Plastic parts

- 1 Dip cloth into neutral detergent, squeeze it and clean.
- 2 Wipe with water-dipped but squeezed cloth.
- 3 Allow to dry.



Clean the controller

- 1 Wipe with soft cloth after squeezing.
- 2 Allow to dry.



Do not use the thinner, gasoline, alcohol or other chemical materials.



Remote control



About cleaning

- Before cleaning, unplug the electricity, don't touch plug with wet hands.
- Make sure hands are dry when plugging the socket.
- If failed to follow the mentioned instruction, user may get electric shock.

Maintenance

FAQ and Troubleshooting

Trouble	Possible reason	Troubleshooting
The massage chair won't work after power is on.	Check if the control is on or not.	Open control switch
	Not choose massage function	Choose massage function
	Check whether the plug and socket in poor contact.	Make sure plug and socket are connected.
	Wire or plug has damaged.	Please ask manufacturer or authorized maintenance man checking replacement.
	The fuse burned out.	Replace fuse of same specification.
There is beep sound inside the massager while working.	Something wrong with inner circuit	Please ask appointed or authorized maintenance man checking and repairing.
	It is sound of air pump, motor and mechanical parts.	Normal sound, no need to pay attention to it.
Different height of the left roller and right roller.	Massage rollers work on shifts.	Normal, no need to pay attention to it.
Sound suddenly becomes much louder while working.	Check if it is due to long time working.	Turn off the power to have the massager rest for over half an hour before next turn working.
	Inner parts away due to long time work. It's normal	Please ask appointed or authorized maintenance man checking and repairing.
Massage function suddenly stops while working.	Suddenly power-down	Connect the electricity power again
	Setting time is up.	Turn off the power to have the massager rest for over half an hour before next turn working.
Neither the backrest nor the legrest can be lay down.	Check if there are any obstacles; the chair overloads; for the sake of safety, sometimes the massage machine may automatically stop working.	Remove the obstacles; turn off the power to have the massager rest for over half an hour before next turn working.
The chair can't return to its original position.	Excessive operation; setting time is up.	Please ask manufacturer or appointed or authorized maintenance man checking and replacement.
Electric wire or plug give out heat	It may work overload	Turn off the power to have the massager rest for over half an hour before next round working.
	Other abnormal case	Stop using, and ask appointed maintenance man for help.

Others



Note: If the troubles are not caused by above reasons, please turn off the power switch and cut off the power, then contact the manufacturer or service agent to repair your chair.

Technical data

Name	Massage Chair	Power	200W
Model	OS-Monarch	NW/GW	Main body: 73.5/89.7kg Armrest: 16.4/20.5kg Legrest & footrest: 23/25.6kg
Input voltage	<input type="checkbox"/> AC120V, 60Hz <input type="checkbox"/> AC220V, 50/60Hz <input type="checkbox"/> AC240V, 50Hz	Packing size	Main body: 1500×810×850mm Armrest: 995×415×740mm Legrest & footrest: 565×525×560mm (L×W×H)
Safety design	Class I		

Others

*Make your life healthy
and beautiful every day!*

Technical data

Name	Massage Chair	Power	200W
Model	OS-Monarch	NW/GW	Main body: 73.5/89.7kg Armrest: 16.4/20.5kg Legrest & footrest: 23/25.6kg
Input voltage	<input type="checkbox"/> AC120V, 60Hz <input type="checkbox"/> AC220V, 50/60Hz <input type="checkbox"/> AC240V, 50Hz	Packing size	Main body: 1500×810×850mm Armrest: 995×415×740mm Legrest & footrest: 565×525×560mm (L×W×H)
Safety design	Class I		

Others

*Make your life healthy
and beautiful every day!*