

Osaki

Osaki Pro-Capella INSTRUCTION MANUAL

Enjoy the space capsule Massage Chair

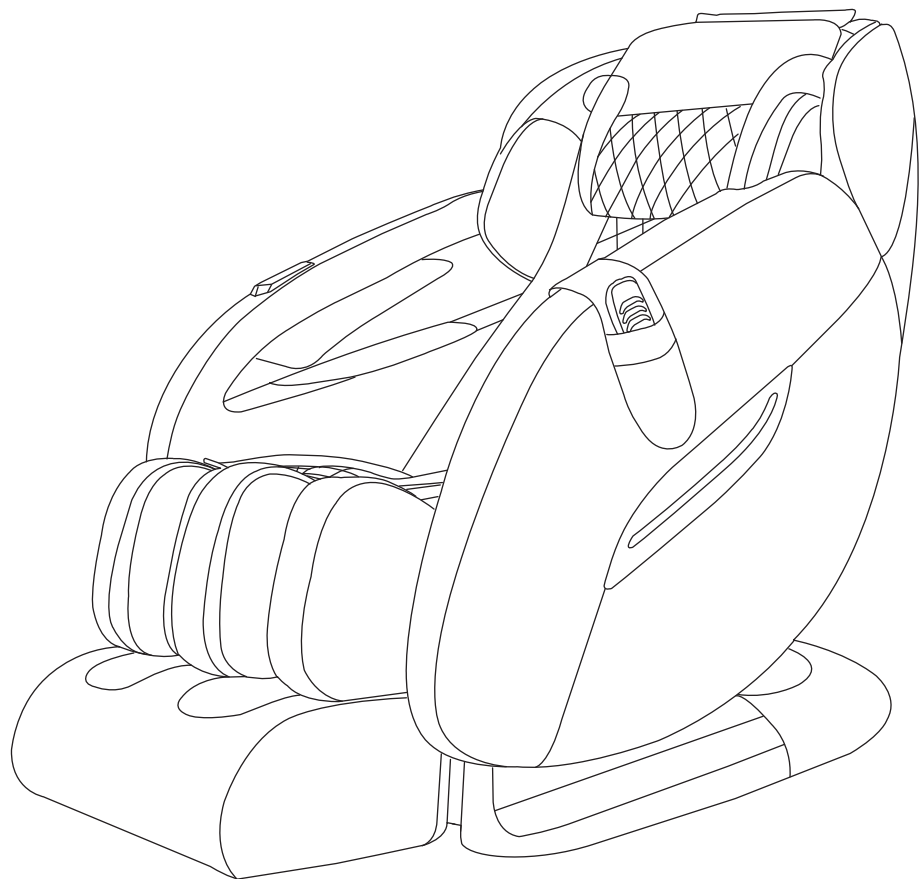

PLEASE BE SURE TO READ THIS MANUAL CAREFULLY TO LEARN THE OPERATIONS OF THIS PRODUCT. DO NOT DISPOSE OF THE MANUAL AND KEEP FOR FUTURE REFERENCE.

CONTENTS

I	IMPORTANT SAFETY INSTRUCTIONS.....	1-5
I	FUNCTION OF EACH PART.....	6
I	INSTRUCTIONS ON CONTROL PANEL	7
I	OPERATION GUIDE	8-14
I	SAFETY INSTRUCTIONS.....	15
I	DAILY CARE AND MAINTENANCE.....	15
I	TROUBLE SHOOTING	16
I	SPECIFICATION	16

IMPORTANT SAFETY INSTRUCTIONS

When using an electrical appliance, basic precautions should always be followed, including the following: Read all instructions before using (this appliance).

DANGER-To reduce the risk of electric shock:

- Always unplug this appliance from the electrical outlet immediately after using and before cleaning.
- Never use pins or other metallic fasteners with this appliance.
- Carefully examine the covering before each use. Discard the appliance if the covering shows any sign of deterioration, such as checking, blistering, or cracking.
- **WARNING**--To reduce the risks of burns, fire, electric shock or injury to persons:
 - An appliance should never be left unattended when plugged in. Unplug from outlet when not in use, and before putting on or taking off parts.
 - Close supervision is necessary when this appliance is used by, on, or near children, or disabled persons.
 - Use this appliance only for its intended use as described in this manual. Do not use attachments that have not been recommended by the manufacturer.
 - Never operate this appliance if it has a damaged cord or plug, if it is not working properly, if it has been dropped or damaged, or dropped into water. Return the appliance to a service center for examination and repair.
 - Do not carry this appliance by the supply cord or use the cord as a handle.
 - Keep the cord away from heated surfaces.
 - Never operate the appliance with the air openings blocked. Keep the air openings free of lint, hair, and the like.
 - Never drop or insert any object into any opening.
 - Do not use outdoors.
 - Do not operate where aerosol (spray) products are being used or where oxygen is being administered.
 - To disconnect, turn all controls to the off position, then remove plug from outlet.
 - Keep children away from the extended foot support.
 - Connect this appliance to a properly grounded outlet only. See Grounding Instructions.
 - Use heated surfaces carefully. May cause serious burns. Do not use over insensitive skin areas or in the presence of poor circulation. The unsupervised use of heat by children or disabled persons may be dangerous.
 - Do not operate under a blanket or pillow. Excessive heating can occur and cause fire, electric shock, or injury to persons.

SAVE THESE INSTRUCTIONS

GROUNDING INSTRUCTIONS

This product must be grounded. If it should malfunction or break down, grounding provides a path of least resistance for the electric current to reduce the risk of electric shock.

This product is equipped with a cord with an equipment-grounding conductor and a grounding plug. The plug must be plugged into an appropriate outlet that is properly installed and grounded in accordance with all local codes and ordinances.

Danger-Improper connection of the equipment-grounding conductor can result in a risk of electric shock.

Check with a qualified electrician or serviceman if you are in doubt as to whether the product is properly grounded. Do not modify the plug provided with the product - if it will not fit the outlet, have a proper outlet installed by a qualified electrician.

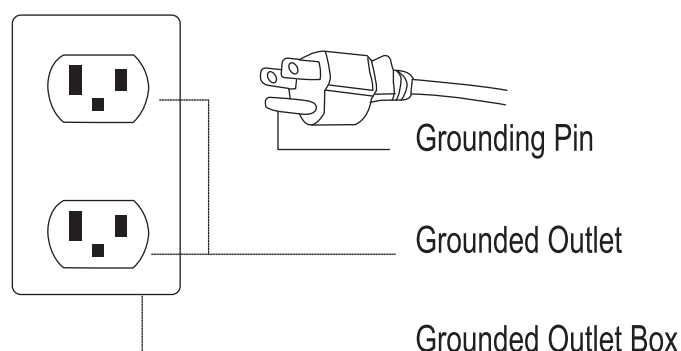

IMPORTANT SAFETY INSTRUCTIONS

OPERATING SURROUNDINGS

- Do not use or store the massage chair in a damp environment : i.e. bathroom, sauna, spa to avoid any mold, electric shock, fire or mechanical failure.
- Do not use the massage chair outdoors
- Do not use the massage chair under dusty, smearable, or anoxic conditions
- Do not place the massage chair near a heater, stove, or near sunlight radiation to avoid inner components overheating and causing fire
- Make sure to place the massage chair on a flat level ground
- The bracket part should be placed on the plain ground
- To avoid electric shock, please make sure to connect an earth wire and have it grounded.
- Don't use the machine while smoking

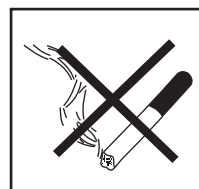
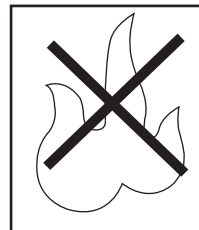

FOLLOWING CONDITIONS SHOULD CONSULT DOCTORS BEFORE USE

- Suffered from malignant tumor
- Serious heart disease
- Serious skin disease
- Serious bone hyperplasia
- During Pregnancy
- Be on the rest cure under the doctor's supervision
- If there is a bend in the back caused by an accident or disease
- Needing peaceful surroundings
- Arthritis Disease
- Implanted pacemaker for medical purpose
- Suffered from bowels disease (i.e. gastritis, enteritis, diarrhea, hepatitis)
- Serious blood circulation trouble
- Consciousness trouble
- In hyperpyretic

WARNING

Children under the age of 18 or people with disabilities (physical and mental) are not allowed to operate the massage chair without a doctor's consent to prevent cases of electric shock, injuries, or mechanism malfunctions.

IMPORTANT SAFETY INSTRUCTIONS

For safety reasons and in order to clearly indicate potential dangers should the product be used improperly, instructions have been marked in the following manners and should be strictly noted

⊘ CAUTIONS

Non-professional technicians are not allowed to dismantle or repair the chair to avoid fire, electrical shock or serious harm



Do not spray or directly pour liquids to the switch when cleaning to avoid insulation fault, electrical shock or short-circuiting.



When moving the chair in the process of storing or maintenance, be sure to disconnect the power plug from socket



Do not detach the plug with wet hands

Make sure to shut off and detach the power plug when cleaning or storing product



During cleaning or moving the machine, make sure to detach power cord to avoid fire or electrical shock

Do not place the machine onto an unstable surface to avoid roasting, insulation failure, electrical shock or turnover



When storing the machine, make sure to disconnect power plug to avoid fire caused by electricity leaking

Clean power plug periodically to avoid fire due to dust



Do not use it in any unsafe places or for other purposes



It is the main reason of product damage or accident

Do not store the machine onto an unstable surface



Unexpected earthquake or external force will cause damage or injury

Keep supply cord unobstructed at all time, i.e. not twisted, knotted, over flexed or pulled and do not place anything heavy on it



The appliance has a heated surface. Persons insensitive to heat must be careful when using the appliance.



IMPORTANT SAFETY INSTRUCTIONS

⊘ CAUTIONS

Do not modify the structure or change components by unauthorized person

Do not dismantle the machine by unauthorized person to avoid electrical shock, short-circuit or fire



Do not store it near a fire or flammable substances

It is one of the reasons of causing product manipulation, deviation, or damage



Should any abnormality occur(i.e. scorching smell), stop using immediately and detach power plug from socket

Operating under an abnormal situation will cause fire or electrical shock, please contact your local seller or authorized service agent for maintenance



Do not place the machine onto an unstable surface to avoid roast, insulation failure, electrical shock or turnover



Only rated voltage must be used



Stop using immediately if supply cord or power plug be damaged or loosen



Be sure to keep children away during operating to avoid any hazard



Do not explore it under sunshine at all time



If the supply cord is damaged,it must be replaced by the manufacturer or its authorized persons for repair or maintenance to avoid any hazard



IMPORTANT SAFETY INSTRUCTIONS

FCC Radiation Exposure Statement:

This equipment complies with FCC radiation exposure requirement.

The device can be used in portable exposure condition without RF striction.

Changes or modifications not approved by the party responsible for compliance could void the users authority to operate the equipment.

This equipment has been tested and found to comply with the limits for a Class B digital device, pursuant to part 15 of the FCC Rules.

These limits are designed to provide reasonable protection against harmful interference in a residential installation. This equipment generates, uses and can radiate radio frequency energy and, if not installed and used in accordance with the instructions, may cause harmful interference to radio communications. However, there is no guarantee that interference will not occur in a particular installation.

If this equipment does cause harmful interference to radio or television reception, which can be determined by turning the equipment off and on, the user is encouraged to try to correct the interference by one or more of the following measures:

- Reorient or relocate the receiving antenna.
- Increase the separation between the equipment and receiver.
- Connect the equipment into an outlet on a circuit different from that to which the receiver is connected.
- Consult the dealer or an experienced radio/ TV technician for help.

FCC Radiation Exposure Statement:

This equipment complies with FCC radiation exposure limits set forth for an uncontrolled environment. In order to avoid the possibility of exceeding the FCC radio frequency exposure limits, Human proximity to the antenna shall not be less than 20cm (8 inches) during normal operation.

INSTALLATIONS GUIDE

Legrest Installation

- ▶ In order to install the footrest make sure that the connecting axis points of the footrest lines up with the seat base as shown in the diagram below. Once aligned tighten the "fixed screw". An Install video will be available online for more detailed instructions. Once completed connect the electrical wire and air pipe as shown in the left illustration.
- ▶ As a final step make sure the air hose is not bent or twisted anywhere before zippering up the seat cushion to the legrest.

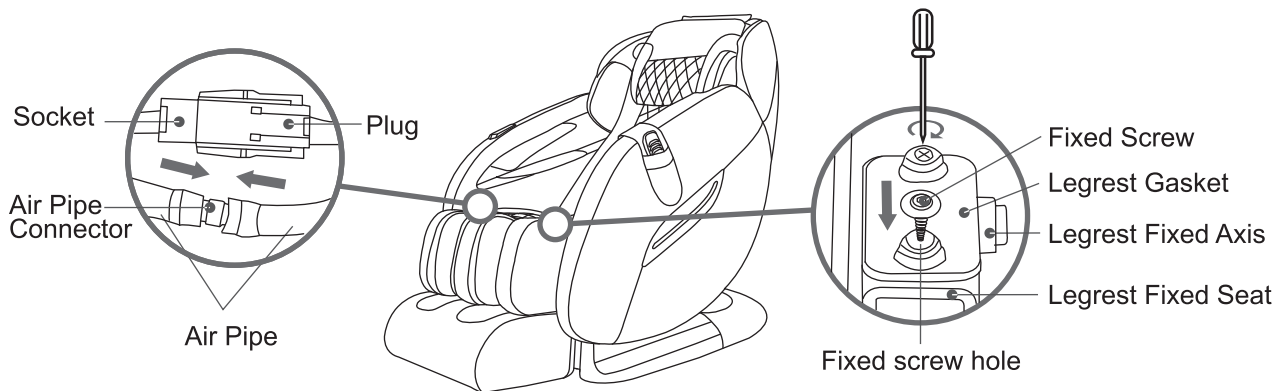

FUNCTION OF EACH PART

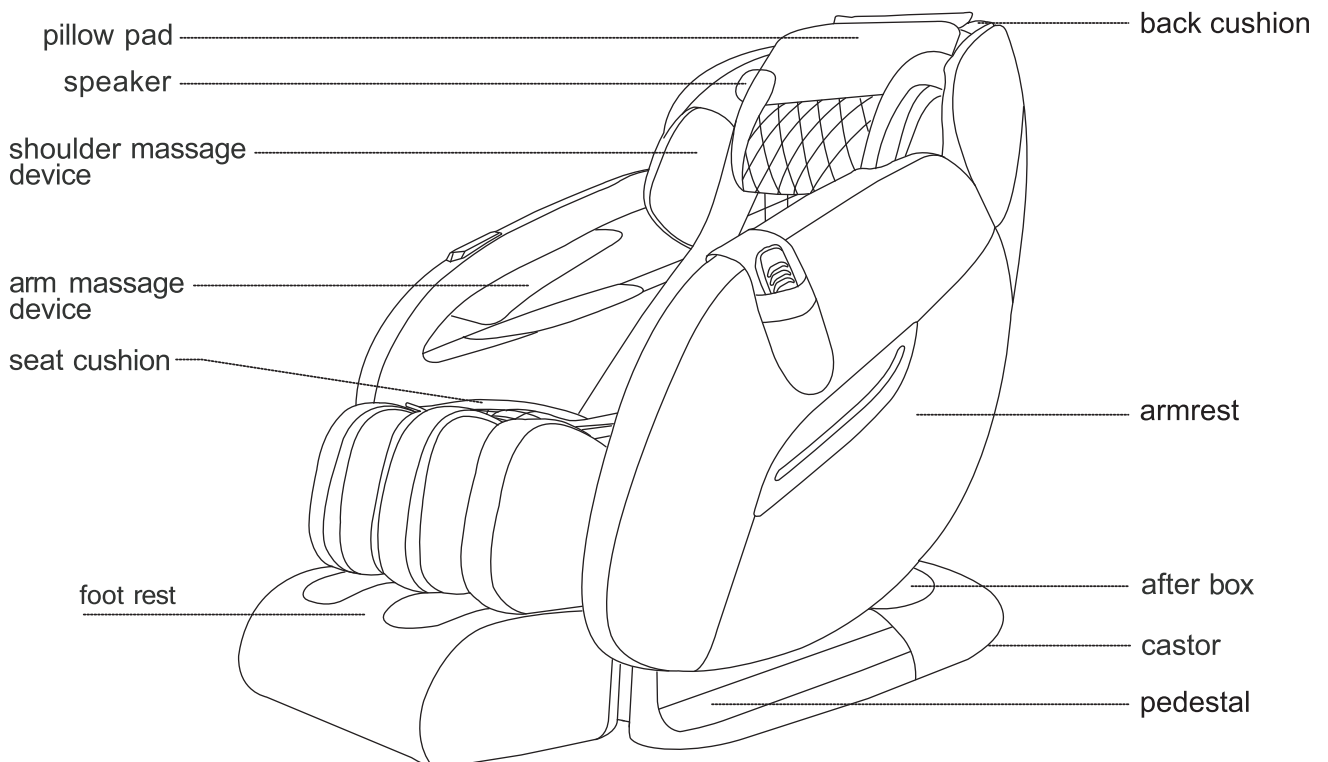

INSTRUCTIONS ON CONTROL PANEL

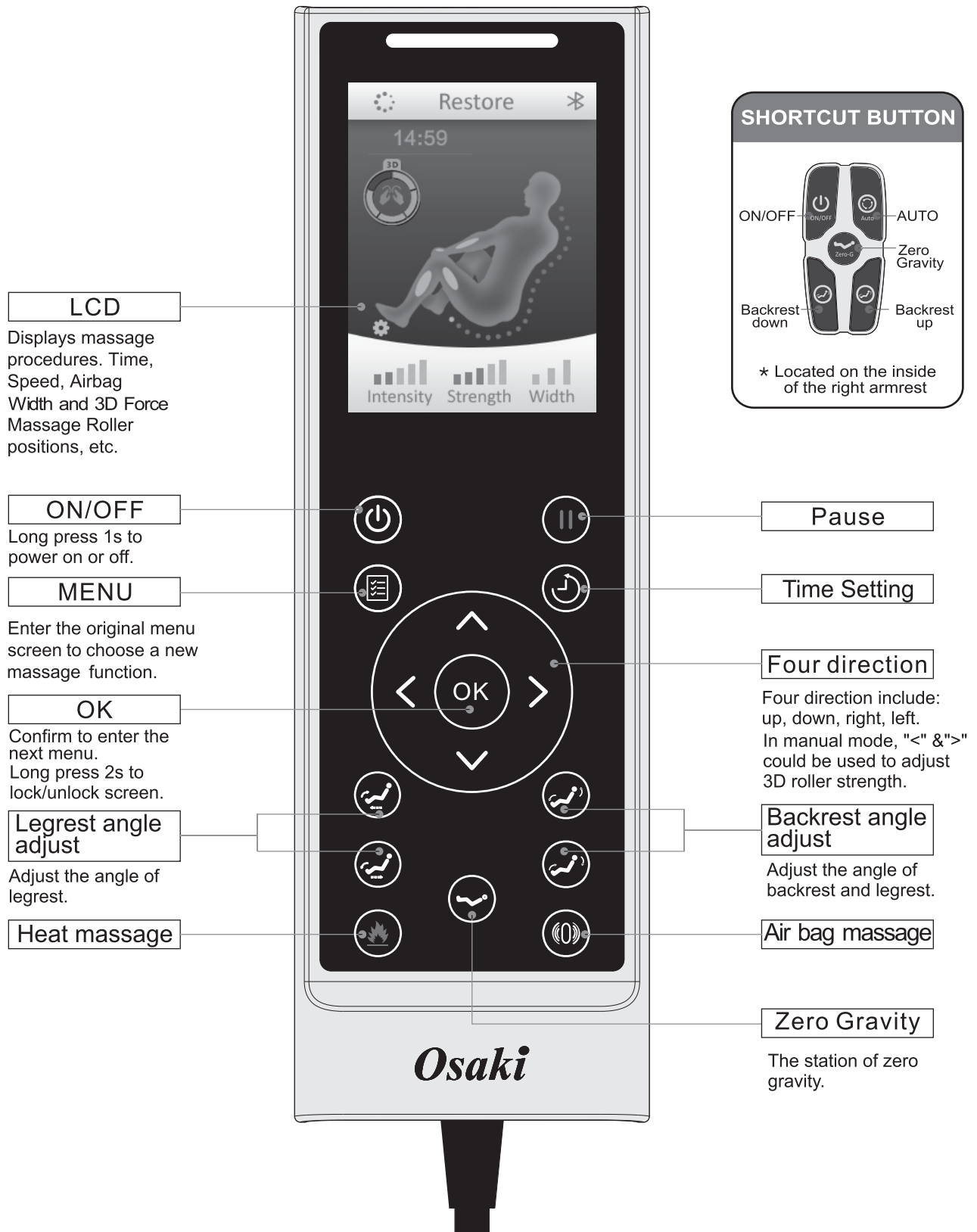

LCD
 Displays massage procedures. Time, Speed, Airbag Width and 3D Force Massage Roller positions, etc.

ON/OFF
 Long press 1s to power on or off.

MENU
 Enter the original menu screen to choose a new massage function.

OK
 Confirm to enter the next menu. Long press 2s to lock/unlock screen.

Legrest angle adjust
 Adjust the angle of legrest.

Heat massage

SHORTCUT BUTTON

ON/OFF AUTO
 Zero Gravity
 Backrest down Backrest up

* Located on the inside of the right armrest

Pause

Time Setting

Four direction
 Four direction include: up, down, right, left. In manual mode, "<" & ">" could be used to adjust 3D roller strength.

Backrest angle adjust
 Adjust the angle of backrest and legrest.

Air bag massage

Zero Gravity
 The station of zero gravity.

* Remote screen will lock automatically if no operation over 1 minute.

Warning: Only rated supply 120V must be used to avoid damage to electronic elements.

OPERATION GUIDE

1. Turn on the power and turn the switch to the “I” position.

- ▶ Insert the power plug into power socket, and push the power switch to “I” position. The chair is in resetting condition, remote power key indicator will flash quickly. After reset, the chair goes to standby mode.

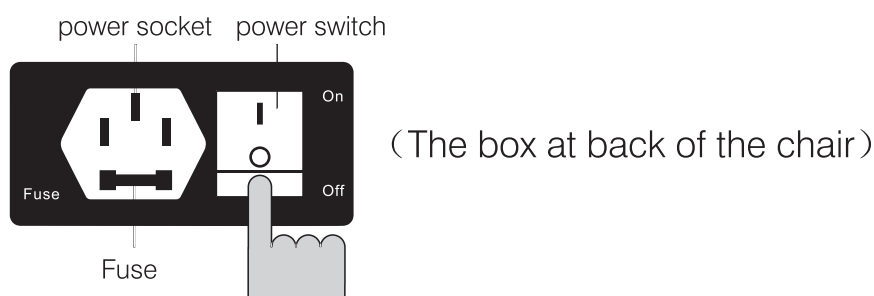

Warning: Do not insert or pull out the power plug with wet hands, otherwise an electric shock would happen.

2. Sit on massage chair and press the “ON” button to start.

- ⏻ Long press ON/OFF button 1s to start , chair will recline to a suitable position. Long press 1s to power off.
- 🕒 Press Time Setting button to adjust massage time. Maximum is 30 minutes.
- ⏸ Press Pause button once, it will stop massage immediately, press again to continue.

3. Adjust backrest and legrest to a favorable angle.

- 🪑 Press once that back and leg move together to lie down, press again to stop.
- 🪑 Press once that back and leg move together to stand up, press again to stop.
- 🪑 Press once to lift up leg, press again to stop. Long press to extend leg automatically.
- 🪑 Press once to pull down leg, press again to stop. Long press to retract leg automatically.

4. Restore massage chair.

- ▶ Press “ON/OFF” button after using. Do not stand in the leg cushion before it restores to original position to prevent any damage to leg cushion.



OPERATION GUIDE

5. Start to massage

Automatic course

Automatic massage program introduction

Operation method:

1. Press “” key to return to main menu.
2. Press “” key to select “AUTO” tab, then press “” key to select below auto programs. Press “OK” key to confirm, roller mechanism will detect shoulder position automatically. When you hear “Beeping”, the detection is finished, at this moment it allows to press the up or down key to fine tune a more accurate shoulder position if needed, then press “OK” key to confirm and start the automatic massage programs.

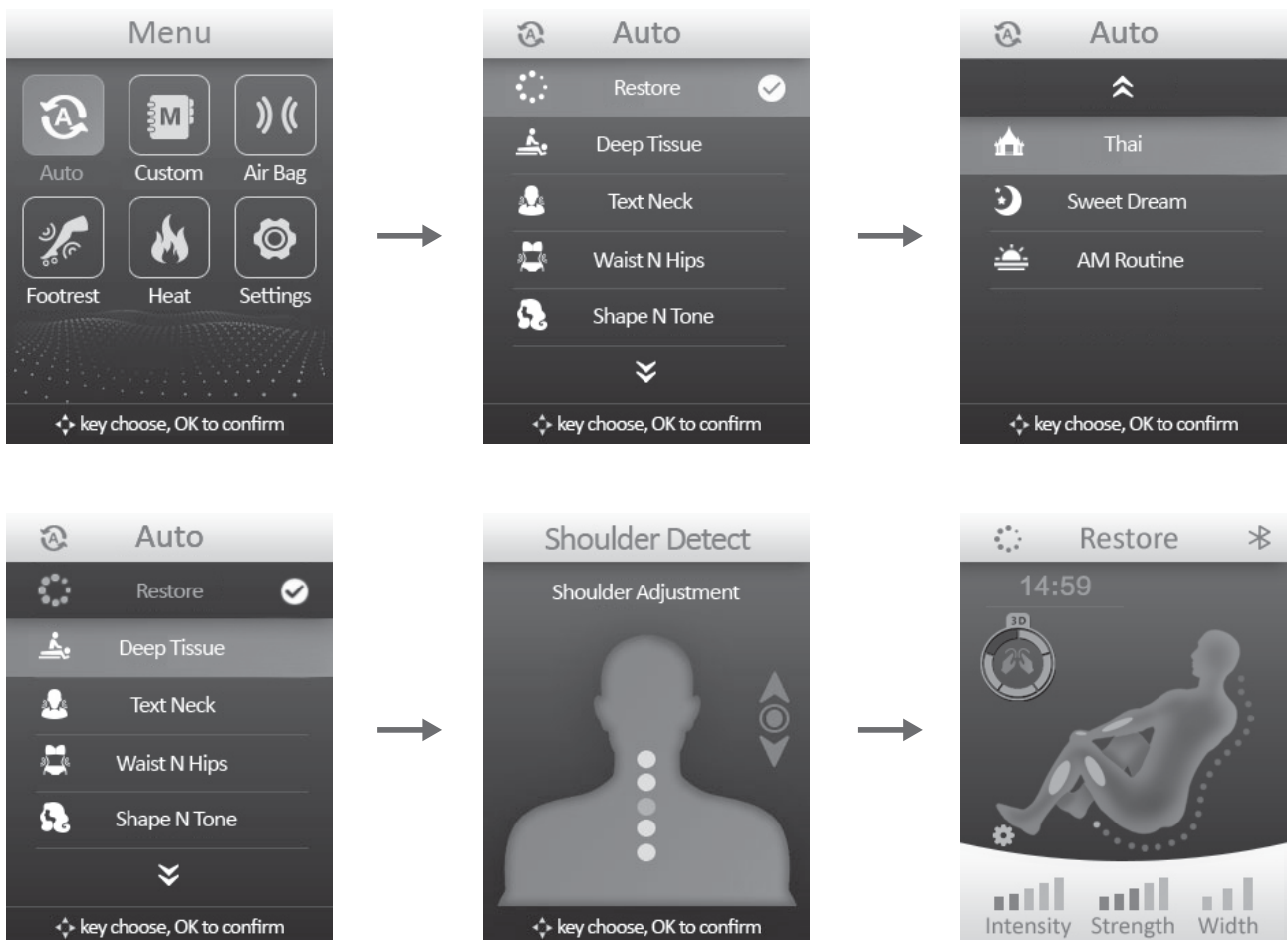

※ Automatic massage programs including the following massages. Each program massage different locations: Kneading finger, pressing, beating, soft hammer, and pressure.

OPERATION GUIDE

Full automatic massage program

Option	Description	Main function and adjustable range
Restore	Restore massage program	※ Engages the body into a relax program, by slow kneading and transitioning.
Deep Tissue	Deep Tissue massage program	※ Switch from Shiatsu to the Main Massage program.
Text Neck	Neck and shoulder massage relaxation program	※ To massage with a kneading beat, main program. Between the adjustable seat and foot position.
Waist N Hips	Waist and hips massage program	※ The massage program mainly kneading scraping. Between the adjustable seat and foot position.
Shape N Tone	Shape N Tone massage program	※ Focused on buttock with full body air massage for body shaping.
Thai	Stretching and relaxing massage program	※ Engages the full body into a stretching program.
Sweet Dream	Sweet Dream massage program	※ Gentle relaxation course based on tapping actions promoting aid in sleep.
AM Routine	AM Routine massage program	※ Combine with types of tapping techniques for back, arms, and legs to relax your full body.

※ Above the program massage time by default to 15 minutes, the setting value of the air pressure is moderate, can choose the "strength" key to adjust the pressure intensity.

Play music

Connecting to Bluetooth

- ▶ To manually connect, first open the Bluetooth Function of the mobile phone, then select the matching Bluetooth Devices (codenamed: "BK8000L" a "beep" sound connects, beep twice and it will disconnect). Standby for the mobile phone will automatically match the massage chair speakers to your phone.

OPERATION GUIDE

Manual massage program

Introduction of manual massage program

Operation method:

1. Press the “

The image shows three sequential screenshots of the device's interface. The first screenshot, titled 'Menu', shows a grid of icons for 'Auto', 'Custom', 'Air Bag', 'Footrest', 'Heat', and 'Settings'. The 'Custom' icon is highlighted. The second screenshot, titled 'Custom', shows a list of massage methods: 'Kneading', 'Tapping', 'Shiatsu', 'Clapping', 'Rolling', and 'Swedish'. The 'Method' label is on the left, and the methods are on the right. The third screenshot shows the 'Custom' screen with a 3D human figure and three bar graphs labeled 'Intensity', 'Strength', and 'Width' at the bottom. The time '14:59' is displayed at the top.

Option	Description	Main function
Method	Kneading	Kneading massage, can adjust the intensity.
	Tapping	Tapping massage, can adjust the intensity and width.
	Shiatsu	Shiatsu massage, can adjust the width.
	Clapping	Clapping massage, can adjust the intensity and width.
	Rolling	Rolling massage, can adjust the intensity.
	Swedish	Swedish massage, can adjust the intensity.

OPERATION GUIDE

Manual massage program





Option	Description	Main function and adjustable range
Area	Full back/Partial/Spot	Full back/Partial/Spot massage Full back → Partial → Spot
WIDTH	Wide narrow regulation	Wide adjustment of massage wheel WIDE → MEDIUM → NARROW
Intensity	Speed adjustment	Speed adjustment of massage wheel 1 → 2 → 3 → 4 → 5 → 6

※ For the above manual setting course, the default setting is spot-specific massage with medium width. Speed and width is adjustable by pressing relative button.

Pressure massage program

Introduction of all kinds of functional buttons, it suitable for Automatic and manual massage program.

Operation method:

1. Press “” key to return to main menu.
2. Press the “ ” left and right keys, select the “Air bag program” tab:
Press “ ” up and down keys to select air pressure massage procedures as your need, and press “OK” key to start.

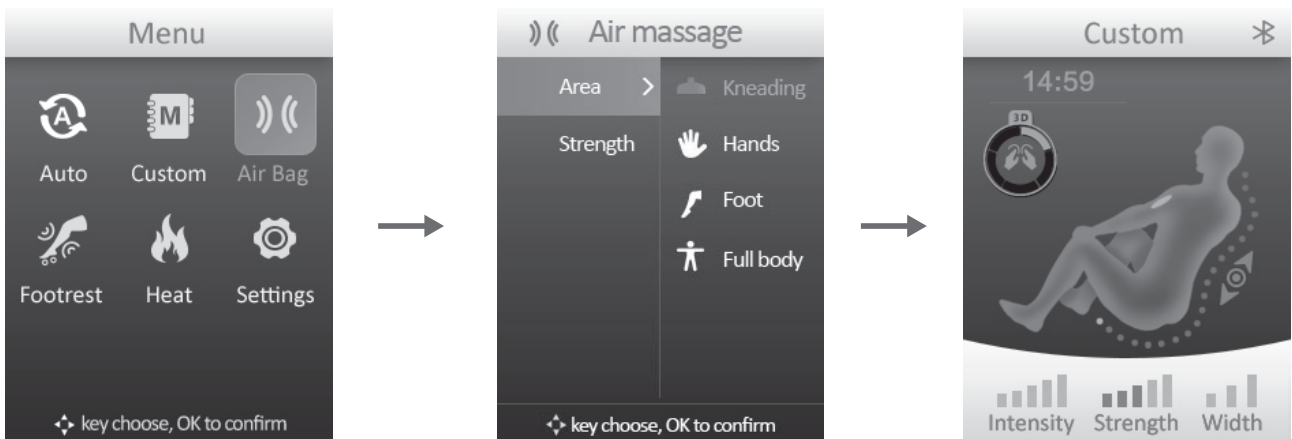

OPERATION GUIDE

Air pressure massage program

Option/Button	Description	Main function and adjustable range
 Area	SHOULDER	Shoulder Pressure Massage Manual Program. The initial strength of the set value can be individually operated on and off.
	Hands	Hands Pressure Massage Manual Program. The initial strength of the set value can be individually operated on and off.
	FOOT	Foot Pressure Massage Manual Program. The initial strength of the set value can be individually operated on and off.
	FULL	Body Pressure Massage Manual Program. The initial strength of the set value can be individually operated.
Strength	Strength Adjust	Intensity adjustment of airbag massage. 1 → 2 → 3 → 4 → 5 → OFF



⚠ Warning: Supervision and guidance is mandatory for those disabled mentally and physically. Please advise with your doctor before using the chair if you have ANY medical conditions. Children under 18 should not use the chair and consult with a doctor for approval if attempted. Do not operate the chair if there are any children or pets near by. Serious injuries may occur if these instructions are not followed.

OPERATION GUIDE



Additional function

Introduction of additional function keys

Operation method:

1. Press the “” menu button to return to the main menu.
2. Press the “

The image shows three sequential screenshots of the device's interface. The first screenshot is the 'Menu' screen with options: Auto, Custom, Air Bag, Footrest, Heat, and Settings. The second screenshot is the 'Footrest' screen with options: Foot Roller, Slow, Mid, Fast, and Off. The third screenshot is the 'Custom' screen showing a 3D human figure and adjustable settings for Intensity, Strength, and Width. Arrows indicate the navigation flow from Menu to Footrest to Custom.

Option/Button	Description	Main function and adjustable range
Foot Roller	Roller speed regulation	Slow → Mid → Fast → OFF
 Heat	Heating massage	On → Off
 Timer	Time setting	5MINS → 10MINS → 15MINS → 20MINS → 25MINS → 30MINS
Key click	Key click	On → Off
Bluetooth	Bluetooth	The exclusive program. Can be opened and closed separately.
Language	Select language	简体中文 → 繁體中文 → English → Malay

SAFETY INSTRUCTIONS

1. Should any abnormality occur, shut off and detach power plug from socket.
2. When the power cord is damaged, it must be changed from a special power cord available from the manufacturer or the service department.



Warning: Do not dismantle, modify, or change components by unauthorized person to avoid electric shock or fire.

DAILY CARE AND MAINTENANCE

Storage guide

- © Do not dismantle back of the chair. Electrical shock may happen when in touch with the inner elements of chair.
- © An unauthorized person must not dismantle the chair to avoid electric shock or fire.
- © Make sure to shut off and detach the power plug when cleaning to avoid electric shock or hazard.
- © Keep the massage chair clean and free of dust. Do not place the massage chair in a damp environment.
- © If not in use for a long period, please cover it with a cloth to free dust.
- © Do not place the massage chair under sunlight.

Maintenance

- © Use neutral detergents only
- © Use neutral detergents to clean the back cushion, head cushion, and leg cushion. Let it dry.
- © Use detergent and cloth to clean the plastic, pipe and leather material of massage chair.
- © Make sure not to use organic solvents as gasoline, amyl acetate, benzene for cleaning to avoid fading of the color, aging, or breakage.
- © Do not spray pesticide to avoid electric shock or fire.
- © Please clean with dry cloth to avoid mechanical failure.

Controller maintenance

- © Do not place the massage chair near heat or fire.
- © Keep away from dampness to avoid electric shock.
- © Please clean dust with a soft cloth or a small banister brush.
- © Make sure not to use violent detergent such as benzene, gasoline, amyl acetate.

TROUBLE SHOOTING

Checking is necessary in frequent usage.

Make sure the machine work properly before usage, after not in use for long time.

Abnormality situation	Solution guide
Failure to start and indicator light is off	<ul style="list-style-type: none"> ◎ Check that the plug is well connected ◎ Check if the switch on the chair is turned to "I" position
Sound in operation	<p>The sound is normal in following situation</p> <ul style="list-style-type: none"> ◎ Sound for kneading or knocking ◎ Sound changes after speed adjustment ◎ Sound from the box in massage ◎ Vibration sound for backrest in massage ◎ Sound for air input and output ◎ Sound for airbag inflating and venting ◎ Sound for leg adjustment ◎ Sound for motor when the massage chair is loaded

SPECIFICATION

Product name	Massage Chair
Model	Osaki Pro-Capella
Power supply	120V~ 60Hz
Rated power	150W
Rated working time	15 min