

MPPT Solar Charge Controller

PTR Tracer AN Series (10A/20A/30A/40A 12V/24V)

INSTRUCTION MANUAL



Models:

PTR1210AN / PTR2210AN

PTR3210AN / PTR4210AN

Important Safety Instructions

This manual contains important information about the safe installation and operation of the solar charge controller. Please keep this manual for future reference.

General Safety Information

- Read the full instruction manual before you begin the installation.
- There are no parts serviceable by users. Do not disassemble or attempt to repair the controller.
- Mount the controller indoors only. Prevent exposure to the elements and do not allow any contact with water.
- Install the controller in a well-ventilated place to ensure adequate heat dissipation from the controller's heat sink.
- Install appropriate external fuses/breakers as recommended.
- Remove all connections between the controller and the battery / PV array or disconnect the appropriate fuses/breakers before the controller is installed.
- Power connections must remain tight to avoid excessive heating from a loose connection.

Contents

1	General Information	1
1.1	Overview	1
1.2	Product Features	2
1.3	Instructions for Accessories	3
1.4	Maximum Power Point Tracking Technology.....	3
1.5	Lead Acid Battery Charging Stages	5
2	Installation Instructions	8
2.1	General Installation Notes.....	8
2.2	PV Array Requirements	8
2.3	Wire Size.....	10
2.4	Mounting and Connections	11
3	Operation	13
3.1	Button Functions.....	13
3.2	LCD Display	13
3.3	Parameters Setting.....	15
3.4	Battery Type.....	17
4	Protection, Troubleshooting and Maintenance	19
4.1	Protection	19
4.2	Troubleshooting.....	20
4.3	Maintenance.....	21
5	Technical Specifications	22
	Annex I: Conversion Efficiency Curves	24
	Annex II: Dimensions.....	28
	Annex III: Optional Accessories	32

1 General Information

1.1 Overview

Thank you for choosing this **Photonic Universe PTR Tracer AN** series MPPT solar charge controller. Equipped with an advanced MPPT control algorithm, negative common grounding and an inbuilt LCD display showing system status and parameters, this product is a practical and a high-performing solution for your solar system.

Using the MPPT algorithm, this controller can quickly and accurately track the ideal maximum power point (MPP) of a photovoltaic array in order to obtain the maximum solar energy output. This significantly improves the efficiency of the solar system.

There are two options for the display function: 1) Built-in LCD display and 2) remote LCD meter (optional, not included). The controller also has a *Modbus* communication protocol interface to enable additional monitoring in various applications (telecoms, household off-grid, street lighting, wireless etc.).

This solar charge controller features comprehensive electronic self-testing and enhanced electronic protection functions which allow it to operate safely and help to reduce the risk of damage to system components resulting from installation errors or system faults.

Features:

- Advanced Maximum Power Point Tracking (MPPT) technology with efficiency greater than 99.5%
- High quality components for excellent system performance, with maximum conversion efficiency of 98%
- Ultra-fast tracking speed and guaranteed tracking efficiency
- Accurately recognises and tracks multiple maximum power points
- Current limiting function in case if solar input is greater than the nominal power input for the controller
- Wide operating MPP voltage range
- 12V/24V DC automatic system voltage detection
- Clear and dynamic built-in LCD display which shows operating data and working conditions
- Multiple load control modes: manual mode, On/Off, On+Timer and test mode
- Pre-programmed charging parameters for Sealed, Gel, Flooded batteries, optional User-defined and Lithium battery types
- Battery temperature compensation function (only for lead acid batteries)
- Real-time energy statistics function

- Overheating power reduction function
- RS-485 communication bus interface and Modbus communication protocol
- External LCD display connection (MT50, optional) and PC connectivity for monitoring and parameter setting
- Firmware updates

1.2 Product Features

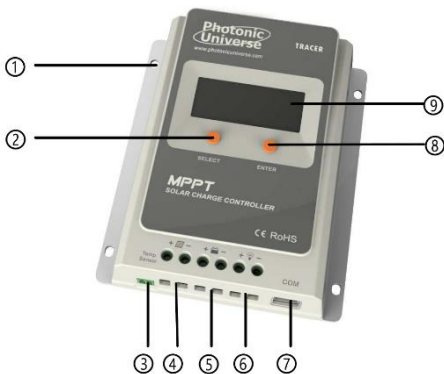

Figure 1.1. PTR Tracer AN Series Product Features

Item	Name	Item	Name
①	Mounting hole size $\Phi 5$	⑥	Load Terminals
②	Select Button	⑦	RS-485 Port**
③	RTS Port*	⑧	Enter Button
④	PV Terminals	⑨	LCD
⑤	Battery Terminals		

Explanations:

* Socket for an RTS (Remote Temperature Sensor) to remotely measure battery temperature.

** Monitor the controller via PC, remote meter MT50, APP or computer and update the controller software via RS485 (RJ45 interface).

1.3 Instructions for Accessories

- 1) Remote Temperature Sensor (Model: TEMP_VS). Measures battery temperature for automatic adjustment of the charging parameters (temperature compensation of voltage). The standard length of the cable is 3m. The TEMP_VS connects to the port (3) on the controller. Note: without the RTS plugged in the battery temperature will be set to a fixed value 25°C.
- 2) Remote Meter (Model: MT50). The digital remote meter displays system operating information and errors and allows parameter setting and self-diagnostics (see Annex III).
- 3) USB to RJ-45 converter (Model: PTR-USB). The USB to RJ-45 converter is used to monitor the solar charge controller using Solar Station PC software. The length of cable is 1.5m. The PTR-USB connects to the RS-485 port on the controller.
- 4) WiFi Module to connect to mobile app (Model: EBOX-WIFI). Creates a Wi-Fi network for your mobile phone or tablet to connect to the free Solar Station mobile app, to monitor and set parameters of the solar charge controller.
- 5) Super Parameter Programmer (Model: SPP-02). Allows for "one-button" parameter configuration (suitable for both single or bulk quantity products).

1.4 Maximum Power Point Tracking Technology

Due to the nonlinear output of a solar panel or solar array, there is a maximum energy point (Max Power Point, or MPP) on the output curve at which the solar panel achieves its highest efficiency. Traditional solar charge controllers with switch charging PWM technology cannot track this highest efficiency point of a solar panel, so most of the time they work with reduced efficiency and do not extract the full energy available from the solar panel. In contrast, this solar charge controller uses Maximum Power Point Tracking (MPPT) Technology which can lock on to the highest efficiency point of a solar panel to extract the maximum energy and deliver it to the battery.

The MPPT algorithm continuously compares and adjusts various points on the output curve of a solar panel to locate the MPP (highest efficiency) point. This tracking process is fully automated and does not require user involvement.

As per Figure 1.2, MPPT technology will 'boost' the battery charging current (amps) through tracking the MPP. Assuming 100% conversion efficiency of the solar system, the battery current will increase in line with the following formula:

$$\text{Input power (P}_{PV}\text{)} = \text{Output power (P}_{Bat}\text{)}$$



$$\text{Input voltage (V}_{MPP}\text{)} * \text{input current (I}_{PV}\text{)} = \text{Battery voltage (V}_{Bat}\text{)} * \text{battery current (I}_{Bat}\text{)}$$

Normally, the V_{Mpp} is always higher than V_{Bat} . Due to the principle of conservation of energy, the I_{Bat} is always higher than I_{PV} . The greater the discrepancy between V_{Mpp} & V_{Bat} , the greater the discrepancy between I_{PV} & I_{Bat} . The greater the discrepancy between the solar and battery voltage, the bigger the reduction of conversion efficiency of a standard controller. Thus by using this MPPT solar charge controller, the efficiency of the PV system can be significantly improved.

Figure 1.2 shows the maximum power point curve of a solar panel. The shaded area is the charging range of a standard PWM controller. The MPPT technology of this controller can shift the point on the curve to the higher current, and raise the efficiency by 20%-30% (on average) compared to a standard PWM controller.

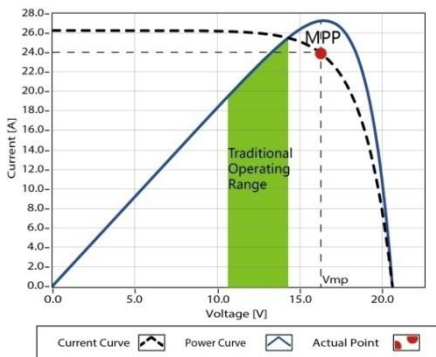

Figure 1.2 Maximum Power Point Curve

In practice, due to shading from clouds, trees, snow etc., a solar panel may have multiple MPP points, but in reality, there is only one true Maximum Power Point (see Figure 1.3 for examples):

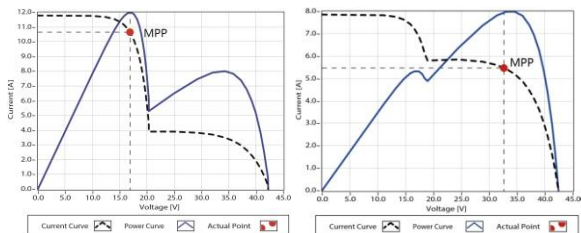

Figure 1.3 Curves with multiple MPP points

Some MPPT solar charge controllers are unable to accurately track multiple MPP points. As a result, they lock on to an incorrect point and work with reduced efficiency. This solar charge controller features special MPPT technology that can handle multiple MPP points and track the true MPP point quickly and accurately, improving system efficiency and avoiding energy wastage.

1.5 Lead Acid Battery Charging Stages

The controller has a 3-stage battery charging algorithm for lead acid batteries (Bulk Charging, Constant Charging and Float Charging) for rapid, efficient, and safe battery charging.

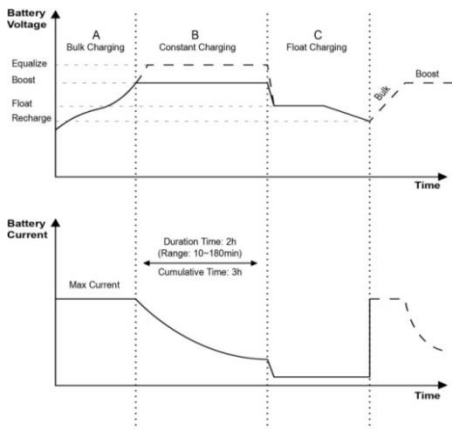

Figure 1.4 Lead acid battery charging stages

A) Bulk Charging

In this stage, the battery voltage has not yet reached the constant voltage point (Equalise or Boost Voltage) and the controller operates in a constant current mode, delivering its maximum current to the batteries (MPPT charging).

B) Constant Charging

When the battery voltage reaches the constant voltage setpoint, the controller will start to operate in a constant charging mode. This process is no longer MPPT charging; the charging current will be dropping gradually throughout this stage. Constant charging has 2 sub-stages: boost and equalise. While boost is a regular charging stage in every full charging cycle, equalise is an infrequent charging stage with higher voltage which is automatically enabled approximately

once a month, for certain battery types.

➤ Boost Charging

The Boost stage lasts 2 hours by default. The user can adjust the constant time and preset value of the boost voltage in settings.

This stage is used to prevent heating and excessive battery gassing.

➤ Equalise Charging



WARNING: Explosive Risk!

Equalising a flooded battery produces explosive gases. Proper ventilation of the battery box is recommended.



CAUTION: Equipment damage!

Equalisation may increase battery voltage to a level that damages sensitive DC loads. Verify that all load allowable input voltages are 11% greater than the equalising charging set point voltage.



CAUTION: Equipment damage!

Over-charging and excessive gas precipitation may damage the battery plates and activate material shedding on them. If voltage is too high or equalizing charge is too long, damage may occur. Please carefully review the specific requirements of the battery used in the system to ensure it can accept equalisation charge.

Some types of batteries benefit from a periodic equalisation charge which can stir electrolyte, balance the battery voltage and complete the chemical reaction. Equalisation charge increases the battery voltage to a higher level than the standard complete charge voltage, which gasifies the battery electrolyte.

The controller will equalise the battery on the 28th day of each month. The equalisation period lasts 0~180 minutes. If the equalisation isn't accomplished in this period, the equalisation recharge time will be accumulated until it is finished. Equalise charge replaces the boost charge – they are not carried out at the same time in a charging cycle to avoid too much gas precipitation or overheating of the battery.

NOTE:

1) If, due to the impact of ambient temperature or load work (discharge) the battery voltage is not steady at a constant voltage setpoint, the controller will accumulate and calculate the time of Constant Charging. When the accumulated time reaches 3 hours, the charging mode will switch to Float Charging.

2) If the controller time is not set to the real time, the controller will equalise the battery once every month following the inner system time.

C) Float Charging

After the Constant voltage stage, the controller will reduce the charging current to the Float Voltage setpoint. This stage will have no more chemical reactions and all the charge current transforms into heat and gas at this time. The controller reduces the voltage to the floating stage, charging at a lower voltage and current. It will reduce the temperature of the battery and prevent gassing. The purpose of Float stage is to offset the power loss caused by self-consumption and small loads in the whole system, while maintaining the battery in a fully charged state.

In Float charging stage, loads are able to obtain almost all power from the solar panels connected to the controller. If loads exceed the available solar panel power, the controller will no longer be able to maintain the battery in the Float charging stage. If the battery voltage drops below the Recharge Voltage, the system will exit Float charging stage and return to the Bulk charging stage.

2 Installation Instructions

2.1 General Installation Notes

- Before you begin installation please read through the entire installation instructions to familiarise yourself with the installation steps.
- Be very careful when working with batteries, especially flooded lead-acid batteries. Wear eye protection and have fresh water available to wash with in case of any contact with battery acid.
- Keep the battery away from any metal objects which may cause a short circuit of the battery terminals.
- Explosive battery gases may be released out from the battery during charging, therefore sufficient ventilation is vital.
- This controller has programs for Gel, Sealed, Flooded lead acid batteries. It also supports User defined / Lithium batteries (can only be set via a computer software using PTR_USB cable). For choosing the right battery program for your battery (including User defined / Lithium battery types) please refer to the battery manufacturer.
- Ventilation is highly recommended when mounting the controller in an enclosure. Never install the controller in a sealed enclosure with flooded batteries! Battery gasses from flooded batteries may cause corrosion and destroy the controller circuits.
- Loose power connections and corroded wires may result in high heat that can melt wire insulation, burn surrounding materials, or even cause fire. Ensure tight connections and use cable clamps to secure cables and prevent them from unnecessary movement.
- Battery connecting cables may be wired to one battery or a bank of batteries. This user manual always refers to a single battery, but it is implied that the battery connection can be made to either one battery or a group of batteries in a battery bank.
- This model of the solar charge controller allows for the installation of more solar charge controllers in parallel (all controllers should be identical), connected to the same battery bank, to achieve a higher charging current. Each controller must have its own solar module(s). The battery (bank) should be able to accept combined current from all controllers.
- Select the system cables according to $5A/mm^2$ or less current density in accordance with all the appropriate regulations and national guidelines.

2.2 PV Array Requirements

➤ **Serial connection (string) of PV modules**

As a core component of a PV system, a controller should be suitable for various

types of PV modules and be able to maximise solar energy conversion. The maximum number of PV modules which can be connected in series and fed into this solar charge controller can be calculated according to the open circuit voltage (V_{oc}) of the PV module and the maximum power point voltage (V_{MPP}) of the controller. The following table is provided for general guidance only; always refer to the exact parameters of your modules to make sure they are within the allowed range.

System voltage	36 cells $V_{oc} < 23V$		48 cells $V_{oc} < 31V$		54 cells $V_{oc} < 34V$		60 cells $V_{oc} < 38V$	
	Max.	Best	Max.	Best	Max.	Best	Max.	Best
12V	4	2	2	1	2	1	2	1
24V	4	3	2	2	2	2	2	2

System voltage	72 cells $V_{oc} < 46V$		96 cells $V_{oc} < 62V$		Thin-Film Module $V_{oc} > 80V$
	Max.	Best	Max.	Best	
12V	2	1	1	1	1
24V	2	1	1	1	1

The above parameter values are calculated under Standard Test Conditions (STC): irradiance $1000W/m^2$, Module Temperature $25\text{ }^\circ\text{C}$, Air Mass 1.5.)

NOTE: If there is a choice between parallel and series connection of solar panels in your system, and the open circuit voltage from the series connection is higher than $80V$, it is recommended to connect PV modules in parallel, to make the controller input PV voltage lower. This would reduce the risk of controller damage in case if the input PV voltage accidentally goes over the maximum threshold (such as in low ambient temperatures).



WARNING: If the maximum open circuit voltage of PV array is more than $96V$ (at the lowest environmental temperature), the controller may be damaged.

When configuring a solar PV array, remember that in all cases the **maximum power point voltage of the array should be greater than the battery charging voltage** to enable charging. For example, it will not be possible to charge a $24V$ battery from a single 36-cell solar panel which delivers $18V$ at the maximum power point.

➤ Current limiting function

This MPPT controller has a limiting function of charging current and power. Even if the input power of the PV modules exceeds the controller nominal rating, the controller can limit the charging current to keep it at the rated value.

Therefore, the actual power that the battery will receive will depend on the following approach:

- 1) If the PV array actual (momentarily generated) power is *less or equal* to controller nominal rated power, the controller will charge the battery at the

actual (full available) power from the PV array.

- 2) If the PV array actual power is *more than* the controller nominal rated power, the controller will reduce the PV array power and charge the battery at its nominal rated power.

If the PV array power is higher than the nominal rated power of the controller, and the controller has to limit the PV power, the battery charging time will be extended accordingly.



WARNING: The controller will be damaged if a PV array is connected to the controller PV terminals with the right or reverse polarity and the max PV power is **more than 1.5 times** the rated controller power!

When the PV array is connected to the controller with either the correct or reverse polarity, the maximum PV array power **must NOT** exceed **1.5** times the nominal (rated) controller power. Please refer to the table below:

Model	Rated Charge Current	Rated Charge Power	Max. PV Array Power	Max. PV open circuit voltage
PTR1210AN	10A	130W / 12V 260W / 24V	195W / 12V 390W / 24V	92V at 25°C 100V at min. environment temperature
PTR2210AN	20A	260W / 12V 520W / 24V	390W / 12V 780W / 24V	
PTR3210AN	30A	390W / 12V 780W / 24V	585W / 12V 1170W / 24V	
PTR4210AN	40A	520W / 12V 1040W / 24V	780W / 12V 1560W / 24V	

Note: the maximum current of the PV array should still be within the nominal (rated) charge current of the solar controller.

2.3 Wire Size

The wiring and installation methods must conform to all national and local electrical code requirements.

➤ PV Wire Size

Since PV array output can vary due to the PV module size, connection method or light exposure, the minimum wire size can be calculated based on the maximum current (Isc) of the PV array. Please refer to the value of Isc in PV module specification. When the PV modules are connected in series, the Isc of the array is equal to Isc of each PV module. When the PV modules are connected in parallel, the Isc of the array is equal to the sum of Isc's of all PV modules. The Isc of the PV array must not exceed the maximum PV input current as per the table below:

Model	Max. PV input current	Max. PV wire size (mm ² /AWG)
PTR1210AN	10A	4/12
PTR2210AN	20A	6/10
PTR3210AN	30A	10/8
PTR4210AN	40A	16/6

NOTE: When the PV modules are connected in series, the open circuit voltage of the PV array must not exceed 92V (25°C)

➤ Battery and Load Wire Size

The battery and load wire size must not be thinner than is required for the rated current as referenced below:

Model	Rated charge current	Rated discharge current	Battery wire size (mm ² /AWG)	Load wire size (mm ² /AWG)
PTR1210AN	10A	10A	4/12	4/12
PTR2210AN	20A	20A	6/10	6/10
PTR3210AN	30A	30A	10/8	10/8
PTR4210AN	40A	40A	16/6	16/6

NOTE: The wire size is for reference only. If there is a long distance between the PV array and the controller or between the controller and the battery, larger wires can be used to reduce the voltage drop and improve performance.

2.4 Mounting and Connections



CAUTION: The controller requires at least 150mm of clearance above and below for proper air flow. Ventilation is highly recommended if mounted in an enclosure.



WARNING: Risk of explosion! Never install the controller in a sealed enclosure with flooded batteries! Do not install in a confined area where battery gases can accumulate.



WARNING: Risk of electric shock! Exercise caution when handling solar wiring. The solar PV array can produce open-circuit voltages in excess of 100V when in sunlight, which could be highly dangerous.

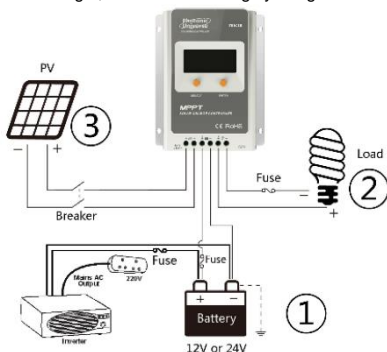

Figure 2.1
Connections

1) Connect components to the charge controller in the sequence 1-2-3 as shown on the diagram above and pay particular attention to the polarity (“+” and “-”) ensuring this is correct. When disconnecting the system, the disconnection order must be reversed to the order of connection (3-2-1).

2) After the battery power has been supplied to the controller check that the LCD display is on. If it's not on, please refer to chapter 4 for troubleshooting. Always connect the battery first in order to allow the controller to recognise the system voltage (12V or 24V).

3) The battery fuse should be installed as close to the battery as possible. The recommended distance is within 150mm of the battery terminal.

4) This solar charge controller has a **negative common ground design** (which means that internally the negative terminals of the solar panel, battery and load are linked, and the charge / discharge regulation happens through the positive terminals). Therefore, any negative terminal of the controller (solar, load or battery) can be earth connected (grounded) if required.



CAUTION: Do not ground any positive terminals of the controller to avoid the risk of damage.

If your system involves a remote temperature sensor for the battery (optional), plug it into the controller socket and mount the sensor on or close to your battery bank.



CAUTION: Without the remote temperature sensor, the controller will set the temperature of battery to the default fixed value 25 °C.



CAUTION: If your system has an inverter do not connect it to the load terminals of the solar charge controller, as most inverters are too powerful for that and above the current rating of the load terminals. Always connect the inverter to the battery terminals directly rather than to the load terminals of the controller.

3 Operation

3.1 Button Functions

Button	Functions
SELECT button	<ul style="list-style-type: none"> • Browse interface • Setting parameters
ENTER button	<ul style="list-style-type: none"> • Load ON/OFF • Clear errors • Enter into Set Mode • Save data

3.2 LCD Display

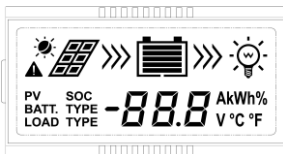

➤ Status Description

Item	Icon	Status
PV array		Day
		Night
		No charging
		Charging
	PV	PV Voltage, Current, Power
Battery		Battery capacity, In Charging
	BATT.	Battery Voltage, Current, Temperature
	BATT. TYPE	Battery Type
Load		Load ON
		Load OFF
	LOAD	Load Voltage, Current, Load mode

➤ Fault Indication

Status	Icon	Description
Battery over discharged		Battery level shows empty, battery frame is flashing, fault icon is flashing
Battery over voltage		Battery level shows full, battery frame is flashing, fault icon is flashing
Battery over temperature		Battery level shows current value, battery frame is flashing, fault icon is flashing
Load failure		Load overload ^① , Load short circuit

①When the load current reaches 1.02-1.05 times, 1.05-1.25 times, 1.25-1.35 times and 1.35-1.5 times the maximum rated controller load current, the controller will automatically turn off the loads in 50s, 30s, 10s and 2s respectively.

➤ Browse interface

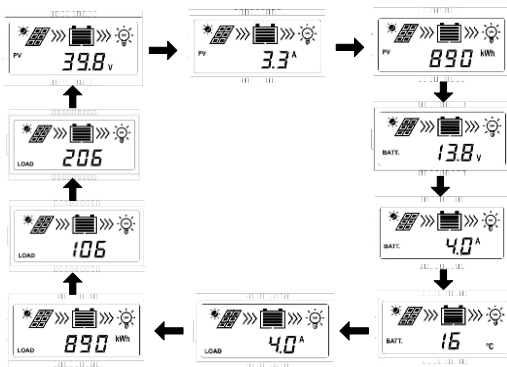

NOTE:

- 1) When not in operation, the interface will automatically cycle, but the following two screens will not be displayed (Load Timer 1 and Timer 2):



- 2) Clearing energy counters for accumulative power: in the PV power (kWh) interface, press ENTER button and hold it for 5s. Then, when the value starts flashing, press ENTER button again to clear the value.
- 3) Changing the temperature unit of measure (C/F): Under the battery temperature interface, press ENTER button and hold it for 5s to switch.

3.3 Parameters Setting

➤ Load mode setting

You can set the Load modes in the following Timer 1 and Timer 2 screens:



Operating Steps:

When in the load mode setting interface, press ENTER button and hold it for 5s until the number starts flashing. Then press SELECT button to set the mode and press ENTER button to save it.

1**	Timer 1	2**	Timer 2
100	Light ON/OFF	2 n	Disabled
101	Load will be on for 1 hour after sunset	201	Load will be on for 1 hour before sunrise
102	Load will be on for 2 hours after sunset	202	Load will be on for 2 hours before sunrise
103~113	Load will be on for 3~13 hours after sunset	203~213	Load will be on for 3~13 hours before sunrise
114	Load will be on for 14 hours after sunset	214	Load will be on for 14 hours before sunrise
115	Load will be on for 15 hours after sunset	215	Load will be on for 15 hours before sunrise
116	Test mode	2 n	Disabled
117	Manual mode (Default load ON)	2 n	Disabled

NOTE: When the Timer 1 is set to Light ON/OFF, Test mode or Manual mode the Timer2 will be disabled and will show "2 n".

➤ Parameters setting

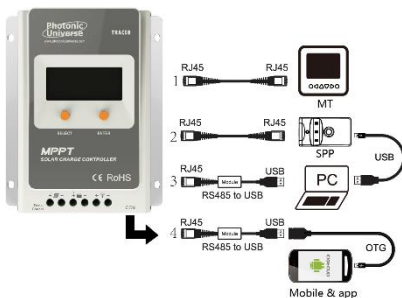

Figure 3.1 Communication options to configure the controller

There are four methods to configure the controller and amend parameters:

1) Remote meter **MT50** (Use the standard network cable supplied with the meter) – see Annex III for details.

2) PC monitoring and setting software “Solar Station Monitor” (use USB to RS485 converter cable **PTR-USB** for linking the controller with your computer).

3) Photonic Universe Solar Station mobile app. In order to use the app, your controller can connect to your phone via:

- WiFi Module **EBOX-WIFI** to create a WiFi network for your mobile phone;
- USB to RS485 converter cable **PTR-USB-2** for connecting the controller to your phone directly.

4) Super parameter programmer **SPP-02** (Use the standard twisted network cable supplied). One-button configuration is available for batch processing.



WARNING: DO NOT connect the controller to any Ethernet socket (such as a network socket on your router or computer) otherwise the controller will be damaged.

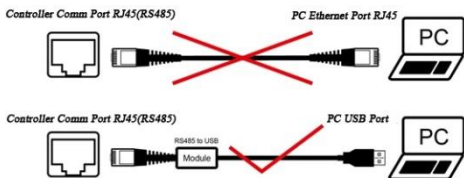

➤ The RJ45 pin interface is defined below:

Pins	Definition
1	Power supply output +5V 50mA
2	Power supply output +5V 50mA
3	RS-485-B
4	RS-485-B
5	RS-485-A
6	RS-485-A
7	Ground
8	Ground

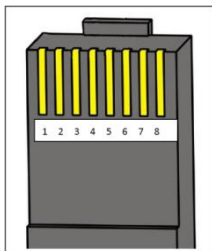

WARNING: The RJ45 interface can only be used for connecting the products we supply or authorise.

3.4 Battery Type

➤ Lead Acid Batteries

Under Battery Voltage interface, press ENTER button and hold it for 5s to enter into the interface of Battery type setting. After choosing the battery type by pressing SELECT button, wait for 5 seconds or press ENTER button again to modify successfully.



① Sealed (Default)

② Gel

③ Flooded

④ User

The user-defined lead acid battery type supports voltages 9-17V (for 12V battery), and 18-34V (for 24V battery). To set this battery type, you will require one of the communication methods described above, such as a remote meter MT50 or PC software "Solar Station Monitor".

➤ Lithium batteries

The controller supports charging a lithium battery (LiFePO4 12V/24V, Li(NiCoMn)O2 12V/24V, User-defined 9-34V). The battery must have its own inbuilt **battery management system (BMS)** including overcharge protection. The battery should have sufficient size to be able **to accept the maximum current** from your solar system. The lithium battery type can only be set and programmed via the PC software "Solar station monitor". Always refer to your battery documentation / supplier or manufacturer for the charging parameters.

Battery Voltage Parameters (lead acid)

(parameters for a 12V system at 25°C, please double the values for a 24V system).

Battery charging setting	Sealed	Gel	Flooded	User
Over Voltage Disconnect Voltage	16.0V	16.0V	16.0V	9~17V
Charging Limit Voltage	15.0V	15.0V	15.0V	9~17V
Over Voltage Reconnect Voltage	15.0V	15.0V	15.0V	9~17V
Equalise Charging Voltage	14.6V	—	14.8V	9~17V
Boost Charging Voltage	14.4V	14.2V	14.6V	9~17V
Float Charging Voltage	13.8V	13.8V	13.8V	9~17V
Boost Reconnect Charging Voltage	13.2V	13.2V	13.2V	9~17V
Low Voltage Reconnect Voltage	12.6V	12.6V	12.6V	9~17V
Under Volt. Warning Reconnect Volt.	12.2V	12.2V	12.2V	9~17V
Under Volt. Warning Voltage	12.0V	12.0V	12.0V	9~17V
Low Volt. Disconnect Voltage	11.1V	11.1V	11.1V	9~17V
Discharging Limit Voltage	10.6V	10.6V	10.6V	9~17V
Equalise Duration (min.)	120	—	120	0~180
Boost Duration (min.)	120	120	120	10~180

NOTE:

1) When the battery type is sealed, gel or flooded, the adjustable range of equalise duration is 0 to 180 min and boost duration is 10 to 180 min.

2) The following rules must be observed when modifying the parameters for User-defined battery type for **lead acid batteries** (factory default value is the same as sealed type):

- a. Over Voltage Disconnect Voltage > Charging Limit Voltage ≥ Equalize Charging Voltage ≥ Boost Charging Voltage ≥ Float Charging Voltage > Boost Reconnect Charging Voltage.
- b. Over Voltage Disconnect Voltage > Over Voltage Reconnect Voltage
- c. Low Voltage Reconnect Voltage > Low Voltage Disconnect Voltage ≥ Discharging Limit Voltage.
- d. Under Voltage Warning Reconnect Voltage > Under Voltage Warning Voltage ≥ Discharging Limit Voltage.
- e. Boost Reconnect Charging voltage > Low Voltage Disconnect Voltage.



CAUTION: Always refer to the user manual or technical specifications for your battery for the correct type and charging settings. If required, contact the supplier of your battery or the manufacturer to confirm charging parameters.

3) The following rules must be observed when modifying the parameters for User-defined battery type for **lithium batteries**:

- a. Over Voltage Disconnect Voltage > Over charging protection voltage (Protection Circuit Modules (PCM)) + 0.2V
- b. Over Voltage Disconnect Voltage > Over Voltage Reconnect Voltage = Charging Limit Voltage ≥ Equalize Charging Voltage = Boost Charging Voltage ≥ Float Charging Voltage > Boost Reconnect Charging Voltage
- c. Low Voltage Reconnect Voltage > Low Voltage Disconnect Voltage ≥ Discharging Limit Voltage
- d. Under Voltage Warning Reconnect Voltage > Under Voltage Warning Voltage ≥ Discharging Limit Voltage
- e. Boost Reconnect Charging voltage > Low Voltage Disconnect Voltage
- f. Low Voltage Disconnect Voltage ≥ Over discharging protection voltage (PCM) + 0.2V



WARNING: The required accuracy of PCM should be at least 0.2V. If the deviation is higher than 0.2V, no liability will be assumed for any system malfunction caused by this.



CAUTION: Due to a wide range of lithium battery types, the exact charging programme and parameters should be confirmed with the battery manufacturer or supplier.

4 Protection, Troubleshooting and Maintenance

4.1 Protection

- *PV Over Current*

The controller will limit the charging power by the rated maximum controller power. In such case an over-sized PV array will not operate at the maximum power point.

- *PV Short Circuit*

When not in PV charging state, the controller will not be damaged in case of a short-circuiting in the PV array. Disconnect the PV and clear the problem.

- *PV Reverse Polarity*

The controller is protected against the reverse PV polarity. No damage to the controller will happen as a result. If you accidentally connect the PV incorrectly, correct the wiring mistake to resume normal operation.



WARNING: The controller will be damaged if the PV array is connected with the reversed polarity and the maximum power of the PV array is 1.5 times greater than the rated controller power.

- *Night Reverse Charging*

Prevents the battery from discharging through the PV module at night.

- *Battery Reverse Polarity*

The controller has full protection against the reverse polarity of the battery connection, no damage to the controller will happen as a result. In case of accidental incorrect connection, correct the mistake to resume normal operation.

- *Battery Over voltage*

When the battery voltage reaches the voltage set point of Over Voltage Disconnect, the controller will stop charging the battery to protect the battery from overcharging.

- *Battery Over discharge*

When the battery voltage reaches the voltage set point of Low Voltage Disconnect, the controller will stop discharging the battery (cut off the load if any load is connected to the load terminals) to protect the battery from deep discharging.

- *Battery Overheating*

The controller detects the battery temperature through the external temperature sensor. If the battery temperature exceeds 65°C, this will automatically trigger the overheating protection. The controller will stop working and resume only below 55°C.

- *Load Overload*

If the load current exceeds the maximum load current rating of the controller by 1.05 times, the controller will disconnect the load. Overloading must be cleared up through reducing the load and restarting the controller.

- *Load Short Circuit*

The controller is fully protected against load wiring short-circuits. Once the load

shorts (more than quadruple rate current), the load short protection will be triggered automatically. After five automatic load reconnect attempts, the fault must be cleared by restarting the controller.

- *Damaged Remote Temperature Sensor*

If the temperature sensor is short-circuited or damaged, the controller will be charging or discharging the battery at the default temperature 25°C as a safety precaution.

- *Lithium Battery Low Temperature*

When the temperature detected by the optional temperature sensor is lower than the Low Temperature Protection Threshold (LTPT), the controller will stop charging and discharging automatically. When the temperature rises above the LTPT, the controller will resume operation. (The LTPT is 0 °C by default and can be set within the range of 10 ~ -40 °C). This protection is for lithium battery only.

- *Controller Overheating*



When the internal temperature of the controller reaches 81°C, the reduced power charging mode will switch on. For every 1°C increase in temperature, the charging power will be reduced by 5%,10%,20%,40%. If the temperature of the controller heat sinks exceeds 85°C, the overheating protection will be triggered automatically. The controller will resume normal operations when the heat sink temperature falls below 75°C.

- *High Voltage Transients*

PV input has limited protection against high voltage surges. In lightning prone areas, additional external suppression is recommended.

4.2 Troubleshooting

Faults	Possible reasons	Troubleshooting
The LCD display is off	Battery connection is broken or it is connected with the wrong polarity	Confirm that PV and battery wire connections are both correct and tight
Wire connection and battery polarity is correct, LCD is still off	Battery voltage is lower than 8V, or a fuse between the battery and controller is blown	Please check the voltage of the battery. At least 8V voltage is required to start the controller. Check the fuse and replace if required.
The LCD display is on, the solar panel is in good light but it is not charging	Incorrect polarity of the solar PV connection or low PV voltage	Check the PV connection polarity and the voltage. The voltage from the PV panels should be higher than the battery charging voltage.
 Interface blinking	Battery voltage higher than over voltage disconnect voltage (OVD)	Check if the battery voltage is too high, and disconnect the solar module

 Interface blinking	Battery low voltage disconnect	Load output is off, the battery is being charged with all available power. Disconnect other loads from the battery (if there are any)
 Interface blinking	Battery over temperature	The controller will stop charging the battery automatically. When the battery cools down, the charging will resume.
 Interface blinking	Over load or Short circuit	Remove or reduce the load and then reconnect it. Restart the controller. Wait for one night-day cycle (night time > 3 hours).

4.3 Maintenance

The following inspections and maintenance tasks are recommended at least twice a year for the best performance:

- Make sure the controller is firmly mounted in a clean and dry place.
- Make sure the air flow is not blocked around the controller. Clear up any dirt and fragments on the heat sink.
- Check all the exposed wires to make sure insulation is not damaged due to sunlight exposure, frictional wear, dryness, insects or rats etc. Repair or replace the wires if necessary.
- Inspect for loose, broken, or burnt wire connections.
- Check and confirm that LCD is consistent with your expectations. Pay attention to any troubleshooting or error indication. Take corrective actions if necessary.
- Confirm that all the terminals have no signs of corrosion, insulation damage, high temperature or burning / discolouration. Tighten terminal screws to the suggested torque.
- Check for dirt, nesting insects and corrosion. If present clear up in time.
- Check and confirm that the lightning arrester is in good condition. Replace with a new one if necessary to reduce the risk of damage to the controller and other equipment.



WARNING: Risk of electric shock! Ensure that the power is turned off before performing the above steps.

5 Technical Specifications

Electrical Parameters:

Item	PTR1210AN	PTR2210AN	PTR3210AN	PTR4210AN
System nominal voltage	12/24VDC Auto ¹			
Rated charge current	10A	20A	30A	40A
Rated discharge current	10A	20A	30A	40A
Battery voltage range	8~32V			
Max. PV open circuit voltage	100V (at the minimum operating environment temperature)			
	92V (at 25 °C environment temperature)			
MPP voltage range	Battery voltage +2V~72V			
Max. PV input power	130W/12V 260W/24V	260W/12V 520W/24V	390W/12V 780W/24V	520W/12V 1040W/24V
Self-consumption	≤12mA			
Discharge circuit voltage drop	≤0.23V			
Temperature compensate coefficient	-3mV/°C/2V (default) ²			
Grounding	Common negative			
RS485 interface	5VDC/100mA			
LCD backlight time	60S (Default)			

1. When a lithium battery is used, the system voltage can't be identified automatically.
2. Temperature compensation is enabled only for lead acid batteries

Environmental Parameters:

Parameter	Value
Working environment temperature range*	-25°C ~ +50°C
Storage temperature range	-25°C ~ +70°C
Humidity range	≤95% (N.C.)
Enclosure	IP30

* Please operate the controller within the permitted ambient temperature. If your application goes beyond the permitted range, contact us for derating of the controller.

Mechanical Parameters:

	PTR1210AN	PTR2210AN	PTR3210AN	PTR4210AN
Dimensions (mm)	172 x 139 x 44	220 x 154 x 52	228 x 164 x 55	252 x 180 x 63
Mounting dimensions (mm)	130 x 130	170 x 145	170 x 164	210 x 171
Mounting hole size (mm)	$\Phi 5$			
Terminals	12AWG (4mm ²)	6AWG (16mm ²)	6AWG (16mm ²)	6AWG (16mm ²)
Recommended cable	12AWG (4mm ²)	10AWG (6mm ²)	8AWG (10mm ²)	6AWG (16mm ²)
Weight (kg)	0.57	0.94	1.26	1.65

We reserve the right to change this manual at our discretion. Please check for updated versions on our website www.PhotonicUniverse.com

Version number: V1.7.10.07.18

Annex I: Conversion Efficiency Curves

Illumination Intensity: 1000W/m² Temp: 25°C

Model: PTR1210AN

1. Solar Module MPP Voltage (17V, 34V) / Nominal System Voltage(12V)

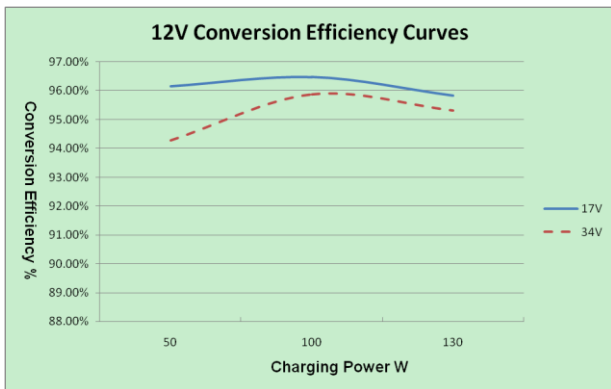

2. Solar Module MPP Voltage (34V, 51V, 68V) / Nominal System Voltage (24V)

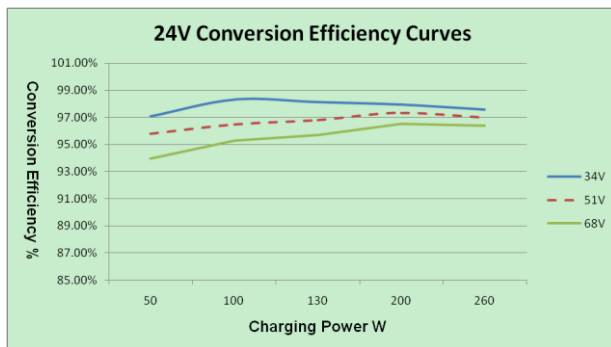

Model: PTR2210AN

1. Solar Module MPP Voltage (17V, 34V) / Nominal System Voltage (12V)

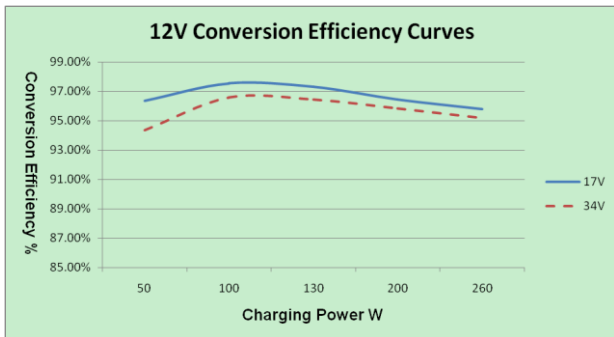

2. Solar Module MPP Voltage (34V, 45V, 68V) / Nominal System Voltage (24V)

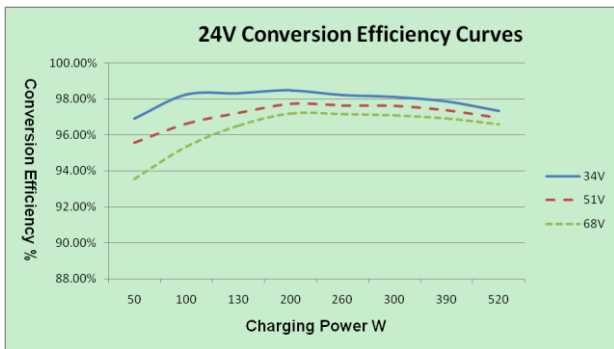

Model: PTR3210AN

1. Solar Module MPP Voltage (17V, 34V) / Nominal System Voltage (12V)

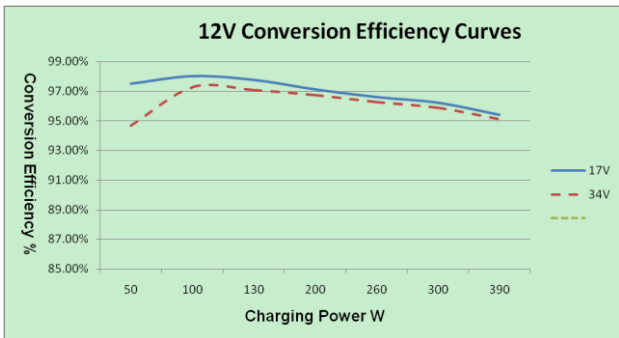

2. Solar Module MPP Voltage (34V, 45V, 68V) / Nominal System Voltage (24V)

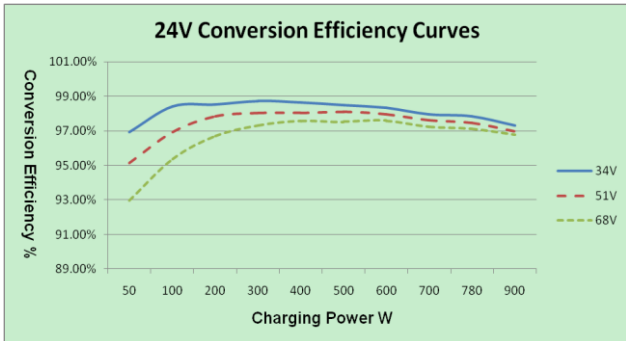

Model: PTR4210AN

1. Solar Module MPP Voltage (17V, 34V) / Nominal System Voltage (12V)

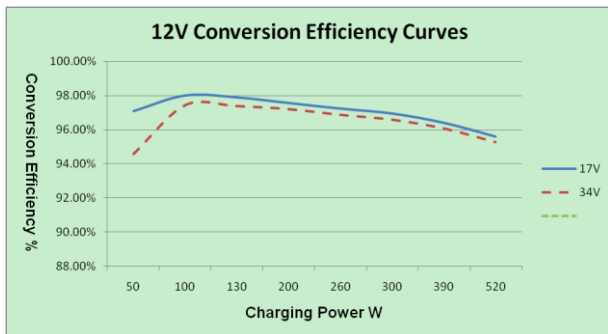

2. Solar Module MPP Voltage (34V, 45V, 68V) / Nominal System Voltage (24V)

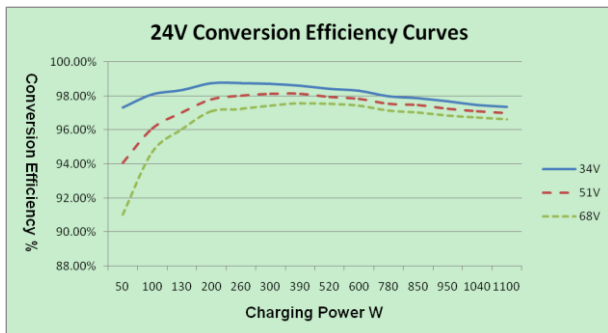

Annex II: Dimensions

PTR1210AN dimensions (mm)

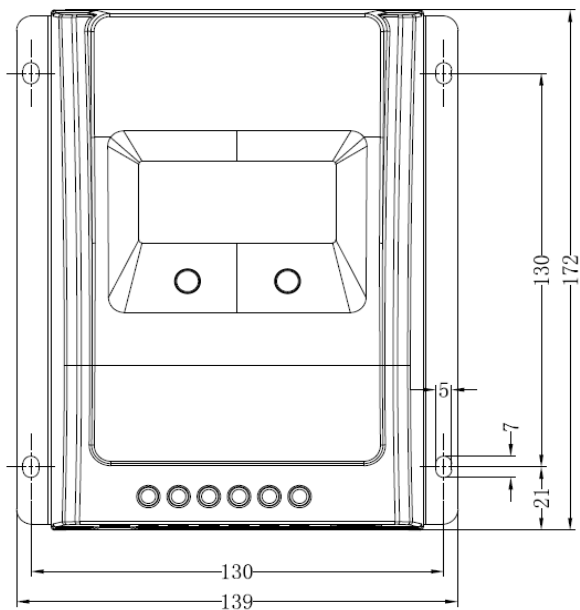
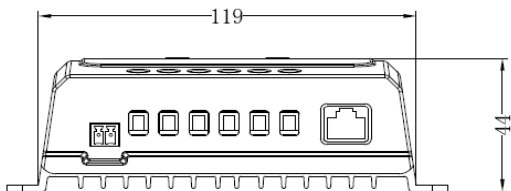

PTR2210AN dimensions (mm)

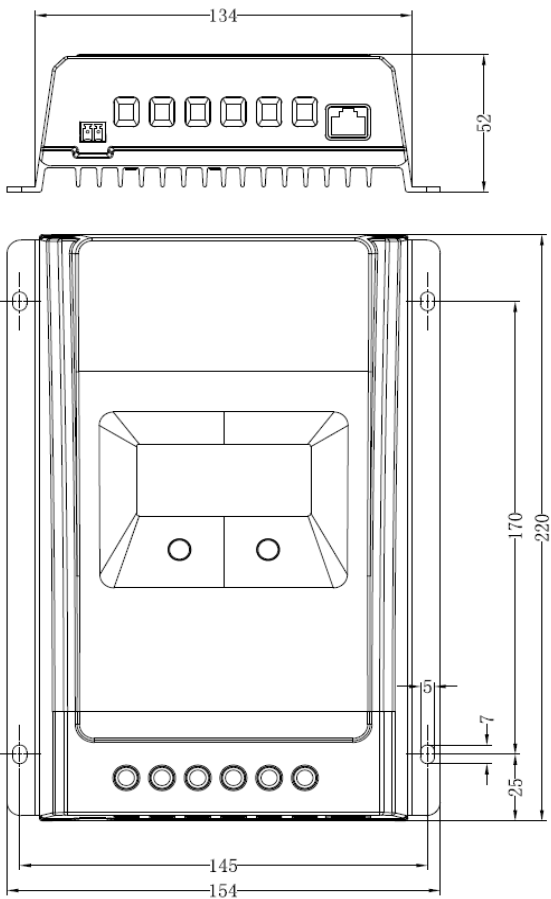

PTR3210AN dimensions (mm)

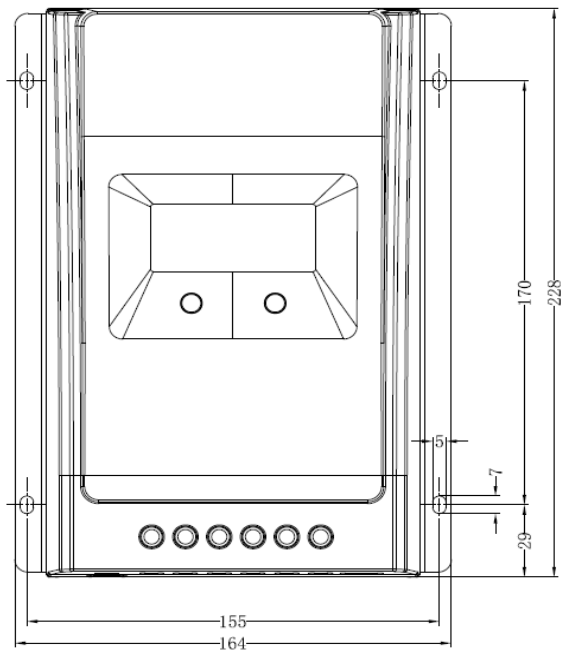
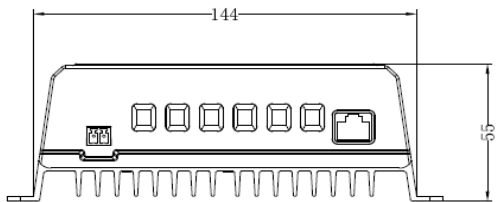

PTR4210AN dimensions (mm)

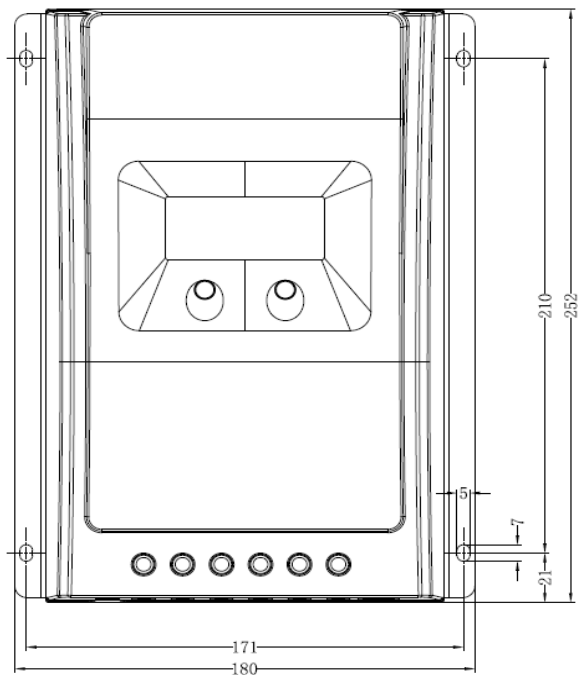
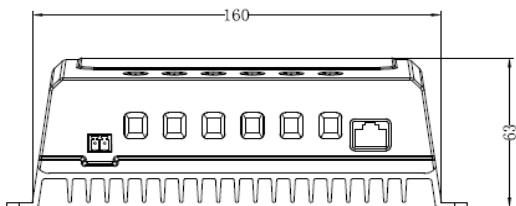

Annex III: Optional Accessories

Remote LCD meter MT50 (optional)

Your **Photonic Universe PTR Tracer AN** solar charge controller has a socket for connecting a remote LCD meter MT50 (purchased separately). This meter can display charging parameters such as battery and solar panel voltage, current (amps), power (watts), accumulated energy and the state of charge of your battery. It also allows modification of various charging parameters listed in **Parameters setting** section of this manual.

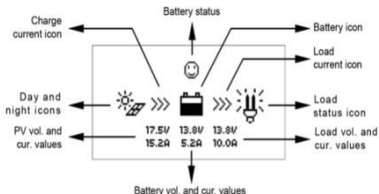

Wi-Fi communication module and the App (optional)

The module **EBOX-WIFI** plugs into the RJ45 socket of your **Photonic Universe PTR Tracer AN** solar charge controller and communicates with the Photonic Universe Solar Station app in your mobile phone to show details about your solar system performance. It will also allow you to adjust the charging parameters of your solar charge controller.

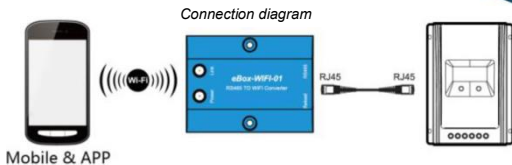

If you would like to buy any of the above optional products for your solar charge controller please visit our online shop

www.PhotonicUniverse.com

Or call 0203 150 1111 (int. +44 203 150 1111) for a phone order.

Photonic Universe

Photonic Universe Ltd

Tel: + 44 (0) 20 3150 11 11

Fax: + 44 (0) 20 3150 12 12

E-mail: info@photonicuniverse.com

Website: <http://www.photonicuniverse.com>