



www.photonicuniverse.com

MPPT Dual Battery Solar Charge Controller
DM Series (10A/20A/30A 12V/24V)
INSTRUCTION MANUAL



Models:

DM1024 / DM2024 / DM3024

Important Safety Instructions

This manual contains all the instructions for safety, installation, and operation for DuoRacer series MPPT Dual Battery Solar Charge Controller (referred to as the controller in this manual). Please keep this manual for future reference.

General Safety Information

- Read the full instruction manual before you begin installation.
- There are no user-serviceable parts inside the controller. Do not disassemble or attempt to repair the controller.
- Avoid direct sunlight, high temperature, and do not install the controller in locations where water can come into contact with the controller.
- Install the controller in a well-ventilated place to ensure adequate heat dissipation from the controller's heat sink.
- Install appropriate external fuses/breakers as recommended.
- Isolate all connections between the controller and the battery / PV array before performing any work on the controller.
- Power connections must remain tight to avoid overheating from a loose connection.

CONTENTS

Important Safety Instructions	3
1. Overview	5
1.1 Information & Features.....	5
1.2 Product Features.....	6
1.3 Starter battery (BATT2) instructions	7
1.4 AES Signal Output Port Instructions	8
1.5 Accessories	9
2. Installation	10
2.1 Warning	10
2.2 PV Array Requirements.....	11
2.3 Wire Size	13
2.4 Mounting	14
3. Display	18
3.1 LCD Display	18
4. Protections, Troubleshooting & Maintenance.....	24
4.1 Protections	24
4.2 Troubleshooting	25
4.3 Maintenance.....	26
5. Specifications	27
Appendix I Mechanical Dimension Diagram.....	29

1. Overview

1.1 Information & Features

Thank you for choosing this **Photonic Universe DM DuoRacer** series MPPT charge controller. This advanced charge controller is made for charging two batteries (referred to as main battery (BATT1) and starter battery (BATT2) below) at the same time in a solar power system.

This controller supports multiple main battery (BATT1) types, including Sealed, Gel, Flooded, LiFePO₄, and Li-NiCoMn, and is ideally suited for motorhomes, campervans, boats, and many other applications. The device recognizes the starter battery (BATT2) system voltage automatically, and trickle charges the battery when the conditions are satisfied.

The controller uses an advanced MPPT control algorithm, which tracks the maximum power point (MPP) of the solar array at high speed with minimal loss time to obtain the maximum energy from solar array under any conditions. The efficiency in an MPPT solar system is increased by at least 20-30% compared with PWM charging methods.

When there is no manual operation for a long time and the charging conditions cannot be reached, the controller will turn to low-power mode which reduces the power self-consumption to prolong the battery life. The system parameters are shown and set by the built-in LCD display or the MT11 remote meter (Accessory).

The controller has a built-in AES control signal for connection to compatible fridges, to supply surplus solar power to the refrigerator and avoid energy waste. The controller comes with IP33 protection from water and dust. Multiple electronic protection features, including battery overcharge protection, over discharge protection, and reverse connection protection of the PV and battery, ensure the safety and stability of the system.

Features:

- Maximum Power Point Tracking technology with ultra-fast-tracking speed and efficiency greater than 99.5%
- Advanced MPPT control algorithm to minimise the MPP loss time
- Wide MPP voltage range to work with many types of panel and solar array
- 12V/24V DC automatic system voltage detection
- Clear and dynamic built-in LCD display which shows operating data and working conditions
- High quality components for excellent system performance and long service life
- Adaptive three-stage charging mode with automatic power and current control to enhance BATT1 life
- Low-power mode automatically activates when there is no manual operation and charging conditions are not satisfied (PV<5V)

- 100% charging and discharging rate across full operating temperature range
- Settings and display units adjustable on the LCD display
- AES control signal for vehicle refrigerator to avoid energy waste
- Standard Modbus protocol, and RS485 (5V/200mA) communication port for system monitoring

① Main battery (BATT1) is the energy storage battery generally used for powering the household loads in the off-grid system, which supports Sealed, Gel, Flooded, LiFePO4, and Li-NiCoMn batteries (the controller does not recognise the system voltage automatically from this input).

② Starter battery (BATT2) is the energy storage battery which usually built in the vehicle for powering the system such as motorhomes and boats, and only supports lead-acid battery (the controller will recognise the system voltage automatically).

NOTE: the BATT1 and BATT2 must be at the same rated voltage.

1.2 Product Features

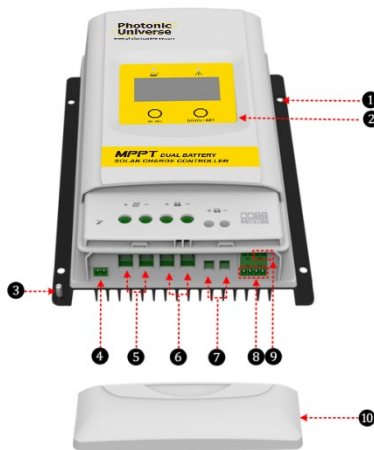

①	Mounting hole size $\Phi 5\text{mm}$	⑥	BATT1 terminals
②	LCD (Refer to chapter 3)	⑦	BATT2 terminals
③	Grounding Terminal	⑧	RS485 Communication port [Ⓜ]
④	Remote temperature sensor [Ⓜ] port	⑨	AES (signal) output port [Ⓜ]
⑤	PV terminals	⑩	Terminal protection cover

① The controller charges BATT1 at default conditions (25°C) without temperature compensation function when not connected to the remote temperature sensor, or when the temperature sensor is damaged. The temperature compensation is ONLY designed for lead-acid battery types. For lithium batteries, there is no temperature compensation and the temperature sensor is used for safety shut-off outside the battery operating temperature range.

② AES port and RS485 port share the output power of 5VDC/Max. 200mA.

The AES signal port is designed for AES compatible vehicle refrigerators. It is required for the internal power switching device in these appliances. AES refrigerators may require a 12V signal, in which case a 5V to 12V adaptor is needed.

1.3 Starter battery (BATT2) instructions

1) Operating principle of starter battery

The controller trickle charges the BATT2 at 1A constant current. When the voltage reaches the "Full Voltage" during the BATT2 charging process, the controller will automatically stop charging.

2) Voltage control parameters of starter battery

Item	Default	Adjustable range
Full Voltage	13.8V/12V; 27.6V/24V	9~17V (24V×2)
Charge Return Voltage	13V/12V; 26V/24V	9~17V (24V×2)



CAUTION: Please follow the rule of Full Voltage > Return Voltage when modifying the voltage control parameters.

3) Start Charging Conditions



CAUTION: BATT2 ONLY supports lead-acid battery type, before starting the BATT2 charging please connect BATT1 first.

Condition 1: BATT2 starts charging when BATT1 reach the float charging stage and the BATT2 voltage is lower than the "Charge Return Voltage".

Condition 2: BATT2 starts charging when the total available charging current is higher than 3A and the BATT2 voltage is lower than the "Charge Return Voltage".

4) Stop Charging Conditions

Condition 1: BATT2 stops charging when the PV voltage is not at least 2V higher than BATT1 voltage.

Condition 2: BATT2 stops charging when BATT1 is not in float charging stage and the total available charging current is less than 2.5A.

Condition 3: BATT2 stops charging when BATT2 reaches the "Full Voltage".



CAUTION: After the BATT2 charging is turned off due to the stop charging conditions, it will be recharged only when the start charging conditions are satisfied again.

5) Starter Battery (BATT2) Charging indication

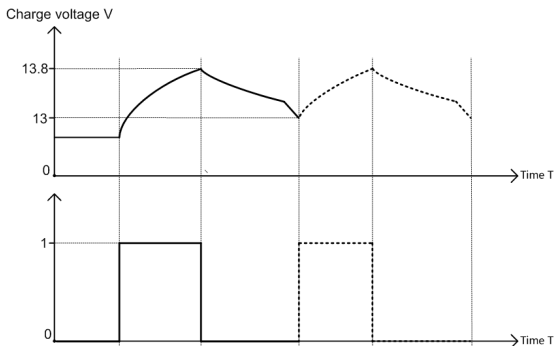

1.4 AES Signal Output Port Instructions

The AES signal port and RS485 port share the power of 5VDC/Max.200mA. Connect a voltage adaptor when connecting a refrigerator, as shown in the below picture.

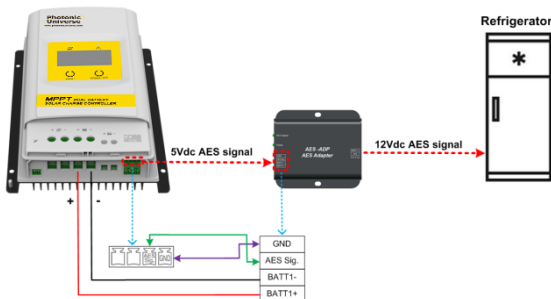

NOTE: The AES signal port and RS485 port share the power of 5VDC/Max.200mA. The MT11 power consumption is 13mA when it is ON, and 4mA when it is off.

3) AES port working principle

- The AES signal turns on after the BATT1 voltage reaches the boost charging voltage or equalize charging voltage for 5 mins.
- The controller will check if the BATT1 is in a state of charging (the boost, equalize or float stage) every 5 mins (This value is the judgement delay time for turning off the AES signal which can be set via PC software, default as 5 mins, ranging from 0 to 999 mins). The AES signal control will be turned off if it meets the conditions 5 times.

1.5 Accessories

Accessories (included):



Local Temperature Sensor (Model: RT-MF58R47K3.81A)



AES signal terminal (Model: 3.81-2P)

A 2P cable is recommended for connecting the AES signal port of the vehicle refrigerator.

Accessories (optional):

1) Remote Meter (Model: MT11)



MT11 can display various operating data and fault information of the system. Operating information can be clearly displayed on a backlit LCD screen, and navigated with easy to operate buttons.

2) Remote temperature sensor (Model: TEMP_VS)



Measures the battery temperature for temperature compensation of charging parameters, the standard length of the cable is 3m (length can be customized). The TEMP_VS connects to the temperature sensor port (4) on the controller.

3) USB to RS485 converter cable (Model: CC-USB-RS485-150U-3.81)



Used to monitor the controller via free Solar Station Monitor PC software. The length of cable is 1.5m. One end connects to the 8 port of controller, the other end connects to the PC by USB port.

4) WIFI Serial Adapter (Model: EBOX-WIFI)



After the controller is connected with the EBOX-WIFI through the 1.5m communication cable (model: CC-RJ45-3.81-150U), the operating status and related parameters of the controller can be monitored by the mobile app through WIFI signals.

5) AES adapter (Model: AES-ADP)



The adapter converts 5V signal output of the controller into 12V of the refrigerator, it will supply the surplus solar power to the refrigerator to avoid energy waste.

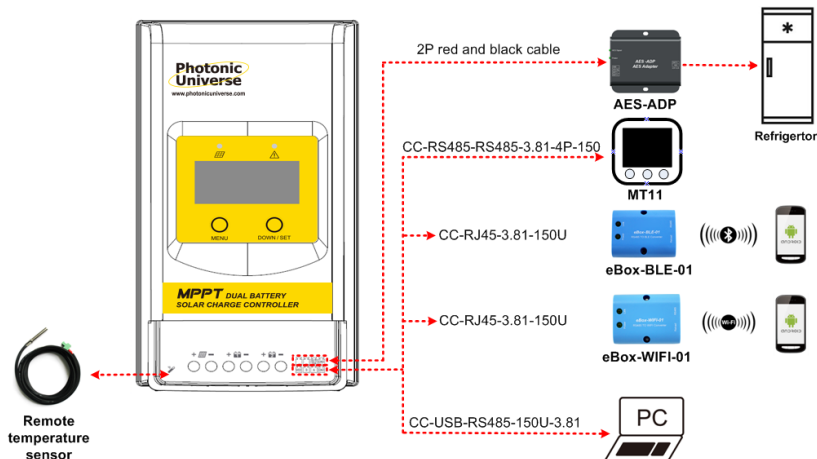

2. Installation

2.1 Warning

- Before beginning installation, please read through the full instructions to familiarise yourself with the steps.
- Be very careful when installing the batteries, especially flooded lead-acid batteries. Please wear eye protection, and have fresh water available to rinse in case of any contact with battery acid.
- Keep the battery away from any metal objects which may cause short circuit of the battery terminals.
- Explosive battery gases may be released from the battery during charging, therefore sufficient ventilation is essential.
- For outdoor installation, keep out of the direct sunshine and rain infiltration.
- Loose connections and corroded wires may result in high heat that can melt wire insulation, burn surrounding materials, or even cause fire. Ensure tight connections and use cable clamps to secure cables and prevent unnecessary movement.
- The controller can only work with lead-acid and lithium batteries of suitable types and voltages.
- Battery connection may be wired to one battery or a bank of batteries. The

following instructions refer to a singular battery, but it is implied that the battery connection can be made to either one battery or a group of batteries in a battery bank provided the overall battery bank voltage is suitable.

- Select the system connection cables according to a current density no greater than 5A/mm².

2.2 PV Array Requirements

➤ Series connection (string) of PV modules

As the core component of solar system, a controller should be suitable for various types of PV modules and be able to maximise solar energy conversion. The maximum number of PV modules which can be connected in series into the solar charge controller can be calculated according to the open circuit voltage (Voc) and the maximum power point voltage (Vmpp) of the MPPT controller. The below table is for general guidance only; always refer to the exact parameters of the PV modules to make sure they are within the allowed range.

DM1024:

System voltage	36cell Voc<23V		48cell Voc<31V		54cell Voc<34V		60cell Voc<38V	
	Max.	Best	Max.	Best	Max.	Best	Max.	Best
12V	2	2	1	1	1	1	1	1
24V	2	2	-	-	-	-	-	-

System voltage	72cell Voc<46V		96cell Voc<62V		Thin-Film module Voc>80V
	Max.	Best	Max.	Best	
12V	1	1	-	-	-
24V	1	1	-	-	-

DM2024 / DM3024:

System voltage	36cell Voc<23V		48cell Voc<31V		54cell Voc<34V		60cell Voc<38V	
	Max.	Best	Max.	Best	Max.	Best	Max.	Best
12V	4	2	2	1	2	1	2	1
24V	4	3	2	2	2	2	2	2

System voltage	72cell Voc<46V		96cell Voc<62V		Thin-Film module Voc>80V
	Max.	Best	Max.	Best	
12V	2	1	1	1	1
24V	2	1	1	1	1

NOTE: The above parameter values are calculated under standard test conditions (STC (Standard Test Condition): Irradiance 1000W/m², Module Temperature 25°C, Air Mass 1.5.)

➤ **Maximum PV array power**

This MPPT controller has a limiting function for charging current and power. Even if the input power of the PV modules exceeds the controller nominal rating, the controller can limit the charging current to keep it at the rated value. Therefore, the actual power that the battery will receive will depend on the following approach:

- 1) If the PV array actual (momentarily generated) power is *less or equal* to controller nominal rated power, the controller will charge the battery at the actual (full available) power from the PV array.
- 2) If the PV array actual power is *more than* the controller nominal rated power, the controller will reduce the PV array power and charge the battery at its nominal rated power.

If the PV array power is higher than the nominal rated power of the controller, and the controller has to limit the PV power, the battery charging time will be extended accordingly.

WARNING: The controller will be damaged if a PV array is connected with **more than 1.5 times** the rated power. When the power of PV is not greater than the rated charging power, but the maximum open-circuit voltage of PV array is more than 60V(DM1024)/100V(DM2024/DM3024) at the lowest environmental temperature, the controller will be damaged.



When the PV array is connected to the controller with either correct or reverse polarity, the maximum PV array power must not exceed 1.5 times the rated controller power or the maximum open circuit voltage. Please refer to the table below:

Model	Rated Charge Current	Rated Charge Power	Max. PV Array Power	Max. PV Open Circuit Voltage
DM1024	10A	130W/12V 260W/24V	195W/12V 390W/24V	46V ^① 60V ^②
DM2024	20A	260W/12V 520W/24V	390W/12V 780W/24V	92V ^① 100V ^②
DM3024	30A	390W/12V 780W/24V	580W/12V 1170W/24V	

① At 25 °C environment temperature.

② At minimum operating environment temperature.

2.3 Wire Size

The wiring and installation methods must conform to all national and local electrical code requirements.

➤ PV Wire Size

Since PV array output can vary due to the PV module size, connection method or sunlight angle, the minimum wire size should be calculated by the "Isc" (short-circuit current) of the PV array. Please refer to the value of Isc in the PV module specifications. When PV modules are connected in series, the Isc is equal to Isc of one of the PV modules in the string. When PV modules are connected in parallel, the Isc is equal to the sum of the PV modules' Isc. The Isc of the PV array must not exceed the controller's maximum PV input current. All panels in an array are assumed to be identical. Please refer to the table as below:

Model	Max. PV input current	Max. PV wire size
DM1024	10A	4mm ² /12AWG
DM2014	20A	6mm ² /10AWG
DM3024	30A	10mm ² /8AWG

Note: When the PV modules connect in series, the rated open circuit voltage of the PV array must not exceed 46V (DM1024), 92V (DM2024 / DM3024).

➤ Battery and load wire size

The battery and load wire size must not be thinner than required for the rated current, as referenced below:

Model	Rated Charge Current	Battery wire size
DM1024	10A	4mm ² /12AWG
DM2024	20A	6mm ² /10AWG
DM3024	30A	10mm ² /8AWG

Note: The wire size is only for reference. If there is a long distance between the PV array and the controller or between the controller and the battery, larger size wires can be used to reduce the voltage drop and improve performance.



CAUTION: The battery cable size recommendations assume that the charge controller is the only device connected to this cable (no inverter connected to the same cable etc).

2.4 Mounting



WARNING: Risk of explosion. Never install the controller in a sealed enclosure with flooded batteries. Do not install in a confined area where battery gas can accumulate.



WARNING: Risk of electric shock. When wiring the solar modules, the PV array can produce a high open circuit voltage when in sunlight. Exercise caution and isolate or cover the panels if needed.



CAUTION: The controller requires at least 150mm of clearance above and below for proper air flow. Ventilation is highly recommended if mounted in an enclosure.

Installation steps:

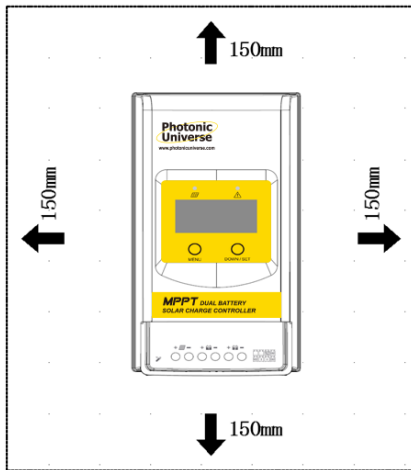

Step 1: Determine installation location and heat-dissipation space

The controller must be installed in a place with sufficient air flow through the radiators of the controller and minimum clearance of 150mm from the upper and lower edges to ensure natural thermal convection.



CAUTION: Ensure that the controller is able to dissipate heat if it is installed in a closed area. If the controller is to be installed in an enclosed box, it is important to ensure reliable heat dissipation through the box walls.

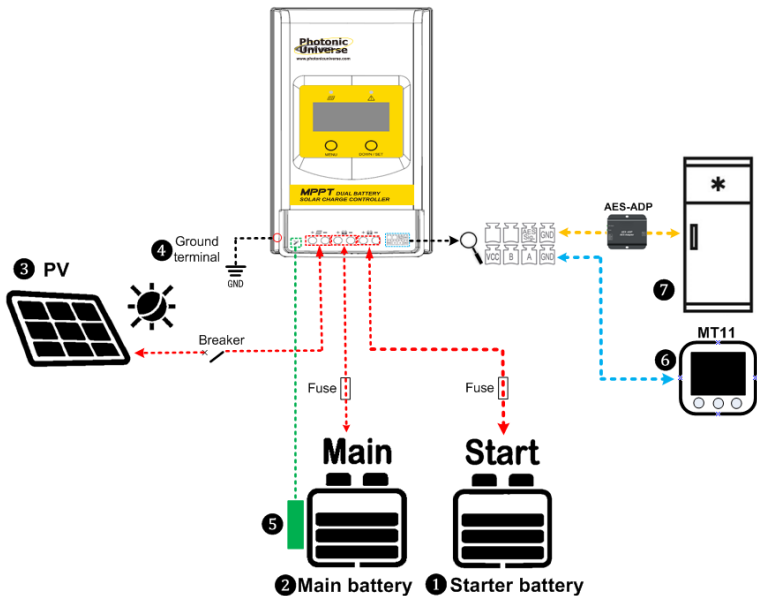

Step 2: Wiring ① ② ③

Connect the system in the order: ① Starter battery (BATT2) → ② Main battery (BATT1) → ③ PV array

Disconnect the system in the reverse order ③ ② ①.



CAUTION: BATT1 and BATT2 must be the same rated voltage.



CAUTION: Follow the above order for wiring, otherwise, it may cause a BATT2 system voltage identification error.



CAUTION: While wiring the controller do not turn on the breaker or fuse and make sure that the poles of "+" and "-" are connected correctly.



CAUTION: A fuse which current is 1.25 to 2 times the rated current of the controller must be installed on the battery side with a distance from the battery no greater than 150mm



CAUTION: If an inverter is to be connected to the system, connect the inverter directly to the battery, and not via any of the solar controller cables.

Step 3: Grounding ④

The DM series is a common-negative controller, where all the negative terminals of PV array and battery are linked and can be grounded simultaneously by grounding any one of these terminals. The negative terminals do not need to be grounded for normal controller function, but the grounding terminal on controller's case must be grounded to shield from electromagnetic interference and protect against electric shock due to electrification of the shell.



CAUTION: For common-negative systems, such as a motorhome, it is recommended to use a common-negative controller. If installed in a system where some common-negative equipment is used and the positive electrode is grounded, the controller may be damaged.

Step 4: Connect the temperature sensor or optional remote temperature sensor cable ④



Temperature sensor
(Model: RT-MF58R47K3.81A)



Remote temperature sensor
(Model: TEMP_VS)

Connect the remote temperature sensor cable to the sensor port (labelled ④ in section 1.2 **Product Features**) and place the other end close to BATT1.



CAUTION: If a temperature sensor is not connected to the controller, the default temperature for battery charging or discharging is 25°C without temperature compensation.

Step 5: Connect the optional remote meter MT11 (1) and optional AES signal of the refrigerator (2)



1 RS485 Communication cable

Models: CC-RS485-RS485-3.81-4P-500 (Included with MT11)

CC-RS485-RS485-3.81-4P-1000 (Optional)

CC-RS485-RS485-3.81-4P-2000 (Optional)

For the operation of the remote meter refer to the user manual of the MT11.

The controller only provides one AES signal control, and the specific application may vary in different systems (see section **1.5 AES Signal Output Port Instructions** for more information).

Step 6: Power on the controller

First, turn on the BATT2 safety switch and check the BATT2 charging indicator status. Then, turn on the BATT1 safety switch and check the BATT1 charging indicator status (See section **3. Display** for more information). Lastly, turn on the PV array circuit breaker or uncover the panels.



CAUTION: If the controller is not operating properly or the battery indicator on the controller shows any abnormality, please refer to section **5.2 Troubleshooting**.

3. Display



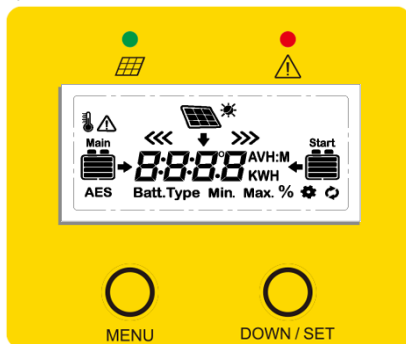



3.1 LCD Display



















(1) Charging indicator

Indicator	Colour	Status	Instruction
	Green	On solid	PV connection normal but low voltage (low irradiance) from PV, no charging.
	Green	OFF	No PV voltage (night time) or PV connection problem
	Green	Slowly flashing (1Hz)	In charging
	Green	Fast flashing (4Hz)	PV overvoltage



(2) Operation interface

Icon	Instruction	Icon	Instruction
Main 	BATT1 battery capacity [Ⓞ] 0~12%	Start 	BATT2 battery capacity [Ⓞ] 0~12%
Main 	BATT1 battery capacity [Ⓞ] 13%~35%	Start 	BATT2 battery capacity [Ⓞ] 13%~35%
Main 	BATT1 battery capacity [Ⓞ] 36%~61%	Start 	BATT2 battery capacity [Ⓞ] 36%~61%

 Main	BATT1 battery capacity ^① 62%~86%	 Start	BATT2 battery capacity ^① 62%~86%
 Main	BATT1 battery capacity ^① 87%~100%	 Start	BATT2 battery capacity ^① 87%~100%
	Day		PV array
	Night		BATT1 charging icon
	Display the parameters of PV		BATT2 charging icon
	Display the parameters of BATT1		BATT1 temperature parameters
	Display the parameters of BATT2	AES	AES signal icon
	Setting icon	Batt. Type	Battery type icon
	Auto global browsing icon	Min.	Minimum voltage icon
	Fault Icon	Max.	Maximum voltage icon

① Battery capacity is calculated by a linear relationship between the LVD voltage and float charging voltage.



Fault indication

Fault	Fault indicator	Charge indicator	LCD	Instruction
BATT1 overvoltage	Red Fast flashing	—		Battery capacity shows full, battery frame blink, fault icon blink.
BATT1 over-discharged	—	—		Battery capacity shows empty, battery frame blink, fault icon blink.
BATT1 over temperature	Red Fast flashing	—		Battery frame blink, fault icon blink, the temperature icon blink, the temperature value blink, the temperature unit blink.

BATT1 system voltage error [®]	Red Fast flashing	Green Fast flashing		Battery capacity shows empty, battery frame blink. Fault icon blinks and battery frame blink
---	-------------------	---------------------	---	---



□ No alarm for system voltage error when BATT1 is set to lithium mode.

(3) Buttons

	Press the button	Parameters of PV array Parameters of BATT1 Parameters of BATT2 Auto global browsing mode (<i>Auto</i>)
	Press the button	Browse the parameters of PV array Browse the parameters of BATT1 Browse the parameters of BATT2
	Press the button and hold for 5s	Select the temperature unit Select the battery type

(1) Auto global browsing mode

Operation:

Press the  button until *Auto* is displayed. Then press the  button,  will appear. The controller is now set to auto global browsing mode.

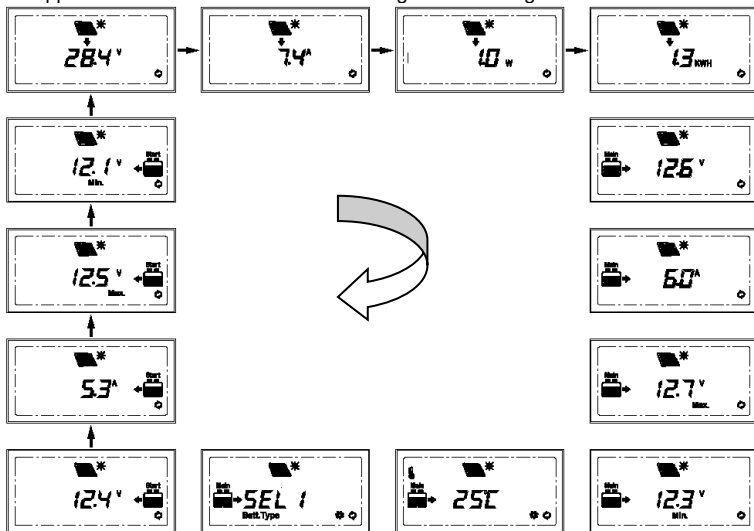

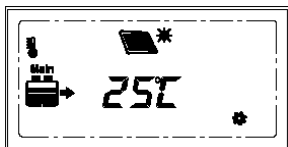

Loop display: PV voltage → PV current → PV power → Generated energy → BATT1 voltage → BATT1 current → Max. BATT1 voltage → Min. BATT1 voltage → BATT1 temperature → BATT1 battery type → BATT2 voltage → BATT2 current → Max. BATT2 voltage → Min. BATT2 voltage → PV voltage

(2) Change Temperature units



Operation:



Step 1: Press the  button under the battery temperature interface until the symbol is flashing.

Step 2: Press the  button to select the temperature unit.

Step 3: Press the  button to confirm.

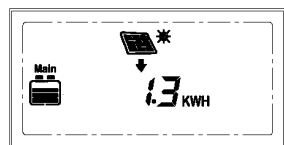
(3) Clear the generated energy



Press the  and  buttons at the same time and hold for 5s to clear the generated energy.

(3) Change Battery type

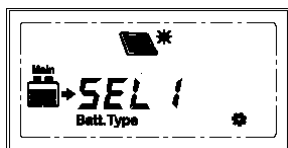

1) Operation:

Step 1: Press the  button and hold for 5s under the battery type interface, until the symbol is flashing.

Step 2: Press the  button to select the battery type.

Step 3: Press the  button to confirm the battery type.

2) Battery type

SEL1	BATT1 12V Sealed	SEL2	BATT1 24V Sealed
GEL1	BATT1 12V Gel	GEL2	BATT1 24V Gel
FLd1	BATT1 12V Flooded	FLd2	BATT1 24V Flooded
LIF4	LiFePO ₄ (4S)	LIF8	LiFePO ₄ (8S)
LIC3	Li-NiCoMn (3S)	LIC6	Li-NiCoMn (6S)
USE	User		

NOTE: The battery control voltage parameters are not changeable when battery is set as default battery types. If you want to change the control parameters, please set the battery type as "User". The control parameters of user battery type can only be set via PC software or mobile app.

1) Lead-acid Battery Control Voltage Parameters

The parameters are in 12V system at 25 °C, please double the values in 24V system.

Battery type Voltage parameter	Sealed	Gel	Flooded	User
Over Voltage Disconnect Voltage	16.0V	16.0V	16.0V	9~17V
Charging Limit Voltage	15.0V	15.0V	15.0V	9~17V
Over Voltage Reconnect Voltage	15.0V	15.0V	15.0V	9~17V
Equalize Charging Voltage	14.6V	—	14.8V	9~17V
Boost Charging Voltage	14.4V	14.2V	14.6V	9~17V
Float Charging Voltage	13.8V	13.8V	13.8V	9~17V
Boost Reconnect Charging Voltage	13.2V	13.2V	13.2V	9~17V
Low Voltage Reconnect Voltage	12.6V	12.6V	12.6V	9~17V
Under Voltage Warning Reconnect Voltage	12.2V	12.2V	12.2V	9~17V
Under Volt. Warning Volt.	12.0V	12.0V	12.0V	9~17V
Low Volt. Disconnect Volt.	11.1V	11.1V	11.1V	9~17V
Discharging Limit Voltage	10.6V	10.6V	10.6V	9~17V
Equalize Duration (min.)	120	—	120	0~180
Boost Duration (min.)	120	120	120	10~180

The following rules must be observed when modifying the parameters value in user battery type (factory default value is the same as sealed type):

- A. Over Voltage Disconnect Voltage > Charging Limit Voltage ≥ Equalize Charging Voltage ≥ Boost Charging Voltage ≥ Float Charging Voltage > Boost Reconnect Charging Voltage.
- B. Over Voltage Disconnect Voltage > Over Voltage Reconnect Voltage
- C. Low Voltage Reconnect Voltage > Low Voltage Disconnect Voltage ≥ Discharging Limit Voltage.
- D. Under Voltage Warning Reconnect Voltage > Under Voltage Warning Voltage ≥ Discharging Limit Voltage.
- E. Boost Reconnect Charging voltage > Low Voltage Reconnect Voltage.

1) Lithium Battery Control Voltage Parameters

The parameters are in 12V system at 25 °C, please double the values in 24V system.

Battery type Voltage parameter	LiFePO ₄ (4S)	Li-NiCoMn (3S)	User
Over Voltage Disconnect Voltage	15.6V	13.5V	9~17V
Charging Limit Voltage	14.6V	12.6V	9~17V
Over Voltage Reconnect Voltage	14.5V	12.5V	9~17V
Equalize Charging Voltage	14.5V	12.5V	9~17V
Boost Charging Voltage	14.5V	12.5V	9~17V
Float Charging Voltage	13.8V	12.2V	9~17V
Boost Reconnect Charging Voltage	13.2V	12.1V	9~17V
Low Voltage Reconnect Voltage	12.4V	10.5V	9~17V
Under Voltage Warning Reconnect Voltage	12.5V	11.0V	9~17V
Under Volt. Warning Volt.	12.0V	10.5V	9~17V
Low Volt. Disconnect Volt.	11.0V	9.3V	9~17V
Discharging Limit Voltage	10.8V	9.3V	9~17V

The following rules must be followed when modifying the value of lithium battery.

- A.** Over Voltage Disconnect Voltage > Over charging protection voltage (Protection Circuit Modules (BMS))+0.2V;
- B.** Over Voltage Disconnect Voltage > Over Voltage Reconnect Voltage = Charging Limit Voltage ≥ Equalize Charging Voltage = Boost Charging Voltage ≥ Float Charging Voltage > Boost Reconnect Charging Voltage;
- C.** Low Voltage Reconnect Voltage > Low Voltage Disconnect Voltage ≥ Discharging Limit Voltage;
- D.** Under Voltage Warning Reconnect Voltage > Under Voltage Warning Voltage ≥ Discharging Limit Voltage;
- E.** Boost Reconnect Charging voltage > Low Voltage Reconnect Voltage;
- F.** Low Voltage Disconnect Voltage ≥ Over discharging protection voltage (BMS)+0.2V.



WARNING: The voltage parameters of lithium battery can be set, but you must refer to the voltage parameters of the lithium battery BMS.







WARNING: The required accuracy of the BMS is at least 0.2V. If the deviation is higher than 0.2V, the manufacturer will assume no liability for any system malfunction caused by this.

4. Protections, Troubleshooting & Maintenance

4.1 Protections

PV Over Current/Power	When the charging current or power of the PV array exceeds the controller's rated current or power, it will charge at the rated current or power.
PV Short Circuit	When not in the PV charging state, the controller will not be damaged in case of a short-circuiting in PV array.
PV Reverse Polarity	When the polarity of the PV array is reversed, the controller may not be damaged and can continue to operate normally after the polarity is corrected. NOTE: If a PV array is reverse connected to the controller with more than 1.5 times rated controller power (watts) the controller will be damaged.
Night Reverse Charging	Prevents the battery from discharging to the PV module at night.
BATT1 and BATT2 Reverse Polarity	Fully protected against battery reverse polarity; no damage will occur to the battery. Correct the wiring to resume normal operation. NOTE: For lithium batteries, when the PV connection is correct and either BATT1 or BATT2 battery connection is reversed, the controller will be damaged.
BATT1 Over Voltage	When the battery voltage reaches the over voltage disconnect voltage, it will automatically stop battery charging to prevent battery damage caused by over-charging.
BATT1 Over Discharge	When the battery voltage reaches the low voltage disconnect voltage, it will automatically stop battery discharging to prevent battery damage caused by over-discharging. (Any controller connected loads will be disconnected. Loads directly connected to the battery will not be affected and may continue to discharge the battery.)
BATT1 Overheating	The controller can detect the battery temperature through an external temperature sensor. The controller stops charging when its temperature exceeds 65 °C and resumes work when its temperature is below 55 °C.
BATT1 Low Temperature (Lithium Battery)	When the temperature detected by the optional temperature sensor is lower than the Low Temperature Protection Threshold (LTPT), the controller will stop charging and discharging automatically. When the detected temperature is higher than the LTPT, the controller will be working automatically (The LTPT is 0 °C by default and can be set within the range of 10 ~ -40 °C).
Controller Overheating	The controller is able to detect the temperature inside the controller. The controller stops working when its temperature exceeds 85 °C and resumes work when its temperature is below 75 °C.
TVS High Voltage Transients	The internal circuitry of the controller is designed with Transient Voltage Suppressors (TVS) which can only protect against high-voltage surge pulses with limited energy. If the controller is to be used in an area with frequent lightning strikes, it is recommended to install an external surge arrester.

4.2 Troubleshooting

Faults phenomenon	Possible reasons	Troubleshooting
Charging LED indicator off during daytime when sunshine falls on PV modules properly.	PV array disconnection	Confirm that PV wire connections are correct and tight.
Wire connection is correct, the controller is not working.	Battery voltage is lower than 8.5V	Please check the voltage of battery is at least 8.5V voltage to activate the controller.
 Battery level shows full, battery frame blink, fault icon blink.	BATT1 over voltage	Check if battery voltage is higher than OVD (over voltage disconnect voltage), and disconnect the PV.
 Battery level shows empty, battery frame blink, fault icon blink.	BATT1 over discharged	When the battery voltage is restored to or above LVR (low voltage reconnect voltage), the load will recover.
 Battery level shows current capacity, battery frame blink, fault icon blink, the temperature icon blink, the temperature value blink, the temperature unit	BATT1 overheating	The controller will automatically turn the system off. When the temperature declines to below 55 °C, the controller will resume.
 Battery level shows empty, battery frame blink.	BATT1 system voltage error	① Check whether the battery voltage match with the controller working voltage. ② Please change to a suitable battery or reset the working voltage.
- System alarm: system voltage error when using Lead-acid battery - System alarm: over discharge fault when the BATT1 is 12V but set as 24V - System alarm: over-voltage fault when BATT1 is 24V but set as 12V	Incorrect wiring steps, should not connect BATT1 first and then BATT2	① Disconnect the system, and reconnect the BATT2 first, then reconnect BATT1 ② BATT1 voltage level should be the same as BATT2

4.3 Maintenance

The following inspections and maintenance tasks are recommended at least two times per year for best controller performance.

- Make sure controller is firmly installed in a clean and dry environment.
- Make sure there is no blockage to air-flow around the controller. Clear up any dirt and fragments on radiator.
- Check all the naked wires for serious solarisation, frictional wear, dryness, insect or rats damage etc. Repair or replace wires if necessary.
- Tighten all the terminals. Inspect for loose, broken, or burnt wire connections.
- Check and confirm that LCD is consistent with expected parameters. Pay attention to any troubleshooting or error indication. Take necessary corrective action.
- Confirm that all the system components are ground connected tightly and correctly.
- Confirm that all the terminals have no corrosion, insulation damage, high temperature or signs of burning/discolouration, tighten terminal screws to the appropriate torque.
- Check for dirt, nesting insects and corrosion and clean if necessary.
- Check and confirm that lightning arrester is in good condition. Replace with a new one in time to avoid damaging of the controller and even other equipment.



WARNING: Risk of electric shock!

Make sure that all the power is turned off before above operations, and then follow the corresponding inspections and operations.

5. Specifications

Electrical Parameters

Item	DM1024	DM2024	DM3024
BATT1 rated voltage		12/24VDC	
BATT2 rated voltage		12/24VDC Auto	
Rated Charge Current	10A	20A	30A
Battery Input Voltage Range		8.5 ~ 32V [Ⓟ]	
Max. PV Open Circuit Voltage	60V [Ⓟ] 46V [Ⓟ]		100V [Ⓟ] 92V [Ⓟ]
MPP Voltage Range	(Battery Voltage+2V) ~ 36V		(Battery Voltage+2V) ~ 72V
Rated Charge Power	130W/12V 260W/24V	260W/12V 520W/24V	390W/12V 780W/24V
Max. conversion efficiency	97.4%	97.5%	98%
Full load efficiency	97%	96%	96%
Self-consumption	12mA/12V;8mA/24V 4mA/12V;3mA/24V (Low-power mode)	26mA/12V;15mA/24V 19mA/12V;10mA/24V (Low-power mode)	
Temperature compensation coefficient ^④	- 3mV/°C /2V(default)		
Grounding	Common negative		
BATT2 Full voltage	13.8V/12V; 27.6V/24V (default)		
BATT2 Charge return voltage	13V/12V;26V/24V (default)		
AES signal port [Ⓟ]	5VDC/Max.200mA (2*(3.81-4P))		
RS485 com. port [Ⓟ]			
Com. baud rate [Ⓟ]	115200 (default)		
LCD backlight time [Ⓟ]	60S (default)		

- ① **Warning:** When a lithium battery of 12V is used and the BMS is protected, the lithium battery voltage may increase up to 35V which may damage the load, so please consider the load's voltage.
- ② At minimum operating environment temperature.
- ③ At 25°C environment temperature.
- ④ The Temperature compensate coefficient is zero and not changeable when the main battery type is lithium battery.
- ⑤ The above two ports share the power of 5VDC/Max. 200mA.
- ⑥ The communication baud rate can only be set via PC software.
- ⑦ The LCD backlight time can only be set via PC software, setting range is 0~999S and the 0s means the LCD backlight is on all the time.

Environmental Parameters

Item	DM1024 / DM2024	DM3024
Working environment temperature (100% input and output)	-20°C ~ +50°C	-20°C ~ +45°C
Storage temperature range	-30°C ~ +80°C	
Relative humidity	≤95%, N.C.	
Enclosure	IP33 3-protection against solid objects: protected against solids objects over 2.5mm. 3-protected against sprays to 60° from the vertical.	
Pollution degree	PD2	

Mechanical Parameters

Item	DM1024	DM2024	DM3024
Dimension	227.2×143×58.1mm	243.7×158×63mm	247.2×165×68.5mm
Mounting dimension	160×134mm	180×149mm	180×156mm
Mounting hole size	φ5mm		
Terminal	12AWG/4mm ² (BATT1) 12AWG/4mm ² (BATT2)	6AWG/16mm ² (BATT1) 12AWG/4mm ² (BATT2)	6AWG/16mm ² (BATT1) 12AWG/4mm ² (BATT2)
Recommended cable size	12AWG/4mm ² (BATT1) 12AWG/4mm ² (BATT2)	10AWG/6mm ² (BATT1) 12AWG/4mm ² (BATT2)	8AWG/10mm ² (BATT1) 12AWG/4mm ² (BATT2)
Weight	0.8kg	1.1kg	1.4kg

Appendix I Mechanical Dimension Diagram

DM1024 (Unit: mm)

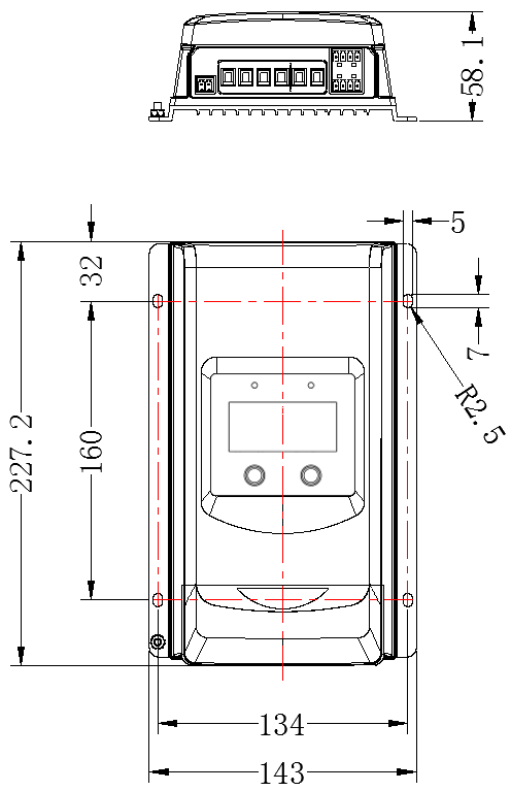

DM2024 (Unit: mm)

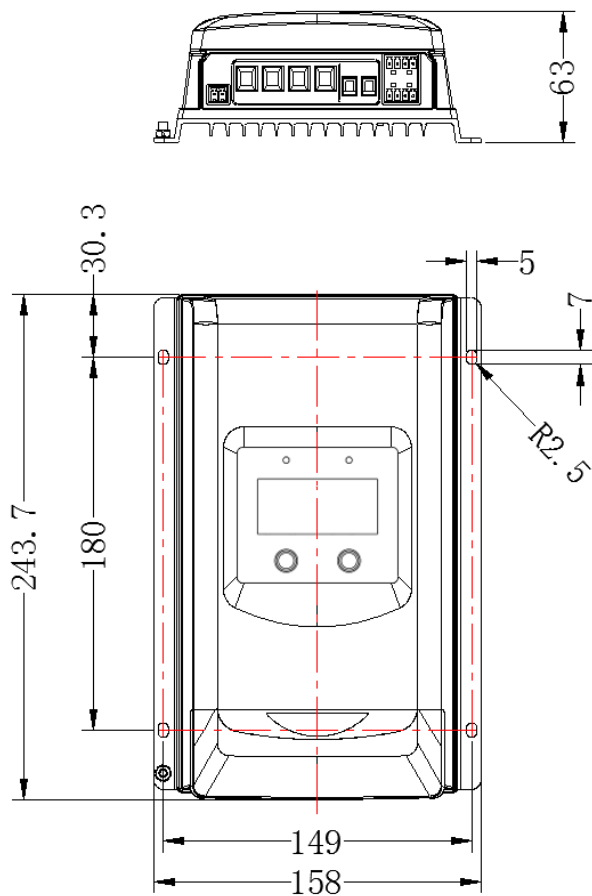

DM3024 (Unit: mm)

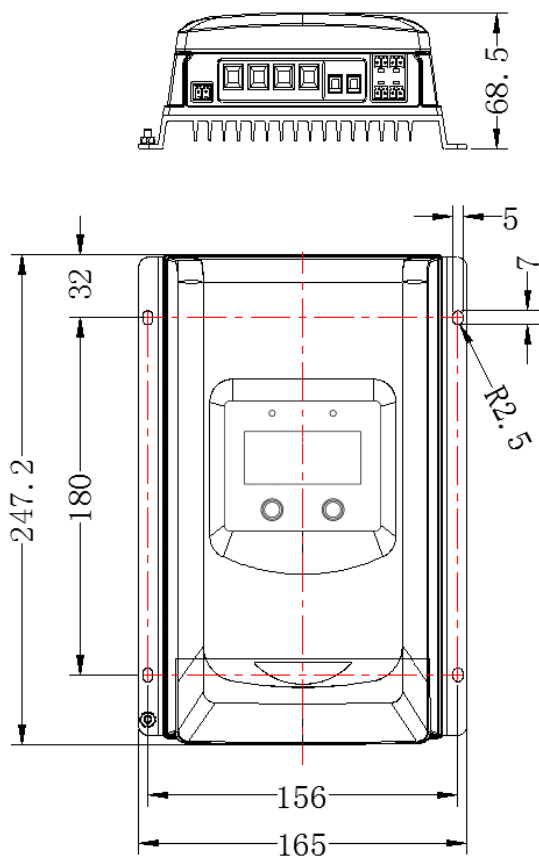

Manual is subject to change without prior notice

Version number: 2.7

Photonic Universe

Photonic Universe Ltd

Tel: + 44 (0) 20 3150 11 11

Fax: + 44 (0) 20 3150 12 12

E-mail: info@photonicuniverse.com

Website: <http://www.photonicuniverse.com>