

brixton series

# window box planter with bracket

black



white



gray



## materials

durable polypropylene construction  
thick gauge galvanized steel brackets  
made in canada

## features

all weather resistant  
crack proof  
fade resistant  
scratch resistant

drainage holes  
5 year limited warranty

## window box thirty-six with brackets

36"L x 11"W x 11"H  
Weight: 26 lbs  
Capacity: 7.6 gal | 34.6 L  
Capacity with Shelf: 6.5 gal | 29.0 L

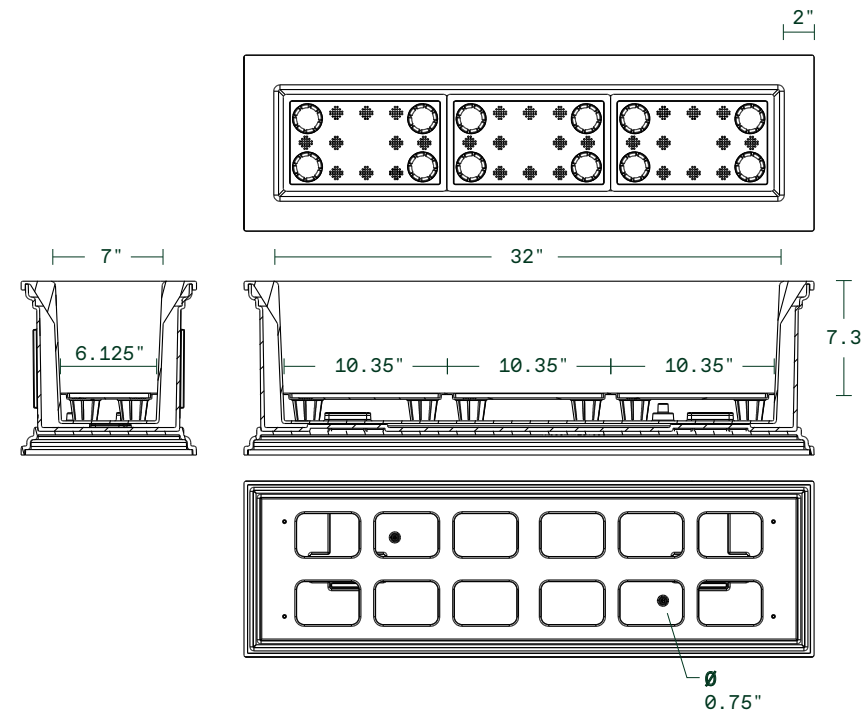

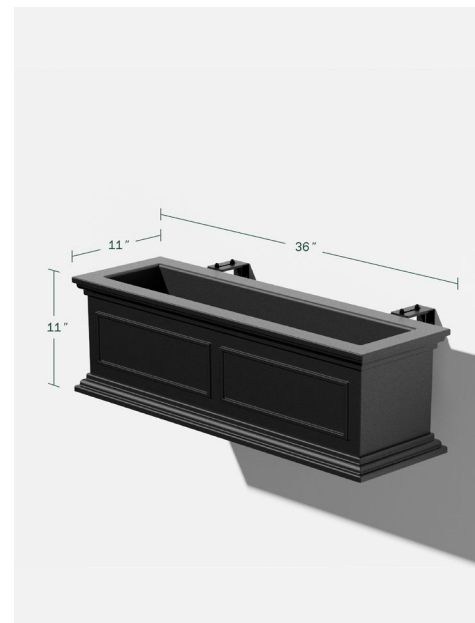
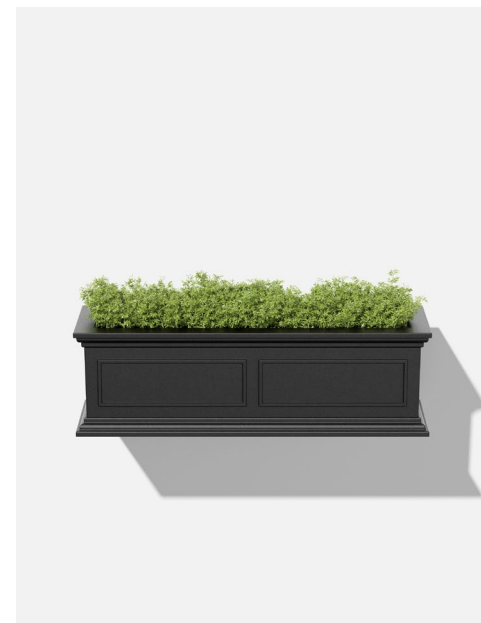

Interior Dimensions

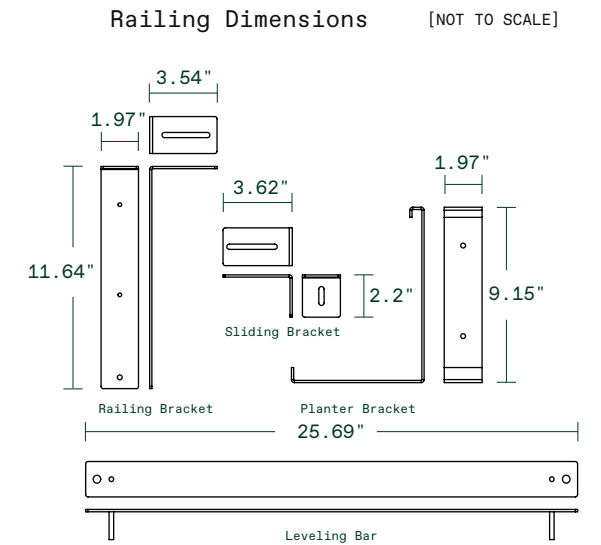

Exterior Dimensions



 Phillips Rounded Head Thread-Forming Screw  
Number 10 Size, 1/2" Long

 Round Head Square Neck Screw (slider bolt)  
M6x1mm Thread, 12mm Long

 Phillips Pan Head Screw  
M6x1mm Thread, 8mm Long

 Cap Nut  
M6x1mm Thread

 Hex Nut  
M6x1mm Thread

Hardware Included