

User's Guide

**Force™ 2
Electrosurgical Generator**

Foreword

This manual and the equipment it describes are for use only by qualified medical professionals trained in the particular technique and surgical procedure to be performed.

Caution

Federal (USA) law restricts this device to sale by or on the order of a physician.

Equipment covered in this manual:

Electrosurgical Generator	Vac Nominal	Hertz
Force 2-2 PCH	110-120	50-60
Force 2-8 PCH	220-240	50-60

Valleylab Part Number: 945 102 179

Effective date: October 2004

Force™ 2, PolyHesive™ and REM™ are trademarks of Valleylab.
Teflon® is a registered trademark of E.I. DuPont de Nemours & Co.

The Force 2 is protected by one or more of the following U.S. patents and their foreign counterparts: 4,632,109, 4,658,819, 4,658,820, 4,827,927, 5,190,517.

Manufactured by:

Valleylab,
a division of Tyco Healthcare Group LP
Boulder, CO 80301-3299 USA

For information call:

1-800-255-8522 / 1-303-530-2300

European Representative:

Tyco Healthcare UK Ltd.
Gosport, PO13 0AS, UK

Made in USA
Printed in USA

© 2004 Valleylab All rights reserved.

Introduction

The Force 2 PCH generators are designed to provide the three most significant electrosurgical effects: cutting, desiccation, and fulguration. The Force 2 generator provides both monopolar and microbipolar outputs for electrosurgery.

The monopolar outputs are designed with the capability of delivering smooth cutting, cutting with increasing degrees of hemostasis, desiccation, and fulguration with minimum cutting. The microbipolar output is intended for desiccation without fulguration.

The Force 2 PCH generators are designed to provide optimal surgical performance in procedures requiring relatively low power settings (e.g., LLETZ, LEEP).

This manual is intended as a user's guide only. Additional technical information and descriptions are available in the service manual.

Conventions Used in this Guide

Warning

Indicates a potentially hazardous situation, which if not avoided, could result in death or serious injury.

Caution

Indicates a hazardous situation, which if not avoided, may result in minor or moderate injury.

► Important

Indicates an operating tip or maintenance suggestion.

Notice

Indicates a hazard which may result in product damage.

Controls, indicators and receptacles on the unit appear in bold italic like this: *Standby Button*



ATTENTION

Refer to the accompanying documents.



Type CF equipment
Low Leakage
Suitable for cardiac use
Defibrillator proof



Drip Proof



CAUTION

To reduce the risk of electric shock, do not remove cover. Refer servicing to qualified service personnel.



The generator is high frequency isolated per IEC 60601-2-2



DANGER

Explosion Hazard: Do not use in the presence of flammable anaesthetics.

Valleylab Service Centers

Valleylab

Boulder, Colorado, 80301-3299
USA
Ph: 303-530-2300
Toll Free: 800-255-8522

Tyco Healthcare Nederland B.V.

Technical Service Center
De Beverspijken 37
5221 EE 's-Hertogenbosch
THE NETHERLANDS
Ph: 073-6312412
Fax: 073-6314540

Auto Suture France S.A.

2, rue Denis Diderot
La Clef de Saint Pierre
78990 Elancourt, FRANCE
Ph: 33 (0)1 30 79 80 40
Fax: 33 (0)1 30 79 85 73

Tyco Healthcare Deutschland

Tempelsweg 26
47918 Tonisvorst, GERMANY
Ph: 49 (0)2151 7096 92
Fax: 49 (0)2151 7096 67

For the UK, Europe, Middle East & Africa: Tyco Healthcare UK Limited Valleylab Service Centre

Unit 1a
Corinium Industrial Estate
Raans Road
Amersham
Bucks. HP6 6YJ
UNITED KINGDOM
Ph: 44 (0)1494 789200
Fax: 44 (0)1494 789239

Tyco Healthcare Italia SpA

Via Gaetano Crespi, 12
20134 Milano, ITALY
Ph: 39 02 212181
Fax: 39 02 2640059

Tyco Healthcare Spain S.L.

C/Fructuos Gelabert, 6 – 8 planta 8a,
08970 – Saint Joan DESPI
Barcelona
SPAIN
Ph: 34-93-680-3370
Fax: 34-93-680-2457

Tyco Healthcare Belgium B.V.

Generaal De Wittelaan 9/5
B-2800 Mechelen
BELGIUM
Ph: 32-15-298111
Fax: 32-15-217987

Tyco Healthcare Austria GmbH

Jochen Rindt Str. 37
A-1230 Vienna
AUSTRIA
Ph: 43-1-610-3441
Fax: 43-1-615-3808

Tyco Healthcare Norden AB (Denmark, Finland, Iceland, Norway, Sweden)

Årstaängsvägen 11 B, II
SE-117 43 Stockholm
SWEDEN
Ph. +46 8 585 605 00
Fax +46 8 585 605 06

Tyco Healthcare PTY Ltd

Service & Technical Support
59 - 69 Halstead Street
Hurstville NSW 2220
AUSTRALIA
Ph: 61 2 9579 6066
Toll free hotline: 1800 350 702
Fax: 61 2 9585 1908

Tyco Healthcare Japan Regulatory Affairs Department Technical Support Section Customer Call Center

1-2-20 Heiwajima Ota-ku Tokyo-to JAPAN
Toll Free : 0120-073-008
Ph: 03-3764-0733
Fax: 03-3764-0744

Auto Suture Company Canada

4490 Garand Street
Ville St. Laurent
Quebec, CANADA H4R 2A2
Ph: 514-334 -7602
Fax: 514-331-5983

Table of Contents

Foreword	ii
Introduction	iii
Conventions Used in this Guide	iv
Valleylab Service Centers	v

Section 1. Patient and Operating Room Safety

Fire/Explosion	1-2
Fire Hazard with Oxygen Circuit Connections	1-3
Electrosurgical Smoke	1-3
Inadvertent Radio Frequency (RF) Burns	1-3
Ensure Proper Connections	1-4
Active Accessories	1-4
Servicing	1-4
Before Surgery	1-5
Active Accessories	1-5
Patient Return Electrodes	1-5
Generator	1-6
During Surgery	1-7
Contact with Metal Objects	1-7
Generator Power Settings	1-7
Forceps	1-7
Suction Coagulators	1-7
Active Accessories	1-8
Patient Return Electrodes	1-9
Laparoscopic Procedures	1-9
After Surgery	1-10

Section 2. Installation

Inspect the Generator	2-1
Responsibility of the Manufacturer	2-1
Preparing the Generator for Use	2-2
Power Requirements	2-2
Check the Power Connector	2-2
Ensure Proper Grounding	2-3
Routine Maintenance	2-3
Cleaning Instructions	2-3

Section 3. Description of Controls, Indicators, and Receptacles

Controls	3-3
Indicators	3-4

Alarms	3-5
Receptacles	3-5
Rear Panel Functions	3-6

Section 4. Instructions for Use

Setting Up the Force 2 Generator for Surgery	4-1
Common Generator/Accessory Setups	4-4
During Surgery	4-6
Monopolar Electrosurgery	4-6
Microbipolar Electrosurgery	4-6
Recommendations During Surgery	4-6
Typical Power Settings	4-7
Low Power Settings	4-8
Low Voltage Coag	4-8
Changing Power Settings	4-9
Activating Accessories	4-10

Section 5. Operating Room Troubleshooting

REM Alarm (two tones)	5-1
Conventional (single-section) Patient Return Electrode	5-1
REM (dual-section) Patient Return Electrode	5-1
No Output	5-4
Monitor Interference	5-4
Continuous Interference	5-4
Interference Only when Generator is Activated	5-4
Neuromuscular Stimulation	5-5
Pacemaker Interference	5-5

Section 6. The REM Contact Quality Monitoring System

Adaptive REM Monitoring	6-2
-------------------------	-----

Appendix A. Technical Specifications

Standard Conditions of Measurement	A-1
Operating Parameters	A-1
Storage and Shipping	A-1
Output Waveform	A-2
PCH Generator Output Characteristics	A-2
Output Configuration	A-2
Input Power Source	A-3
Force 2-2 PCH Generator	A-3
Force 2-8 PCH Generator	A-3
Line Regulation	A-3

Force 2-2 PCH Generator	A-3
Force 2-8 PCH Generator	A-3
High Frequency Risk Parameters	A-4
Low Frequency Leakage (50-60 Hz)	A-4
Force 2-2 PCH Generator	A-4
Force 2-8 PCH Generator (IEC 60601-1, Section 19 for Class 1 Equipment)	A-4
REM Contact Quality Monitor	A-5
Audio Volume	A-5
Approximate Weight	A-5
Size	A-5
Classification	A-5
Type CF Equipment per IEC 60601-1	A-5
Drip Proof per IEC 60601-2-2	A-5

Appendix B. Warranty



Patient and Operating Room Safety

The safe and effective use of electrosurgery depends to a large degree upon factors solely under the control of the operator. There is no substitute for a properly trained and vigilant operating room staff. It is important that the operating instructions supplied with this or any electrosurgical equipment be read, understood, and followed.

Electrosurgery has been used safely in numerous procedures. Before starting any surgical procedure, the surgeon should be trained in the particular technique and surgical procedure to be performed, should be familiar with the medical literature related to the procedure and potential complications, and should be familiar with the risks versus the benefits of utilizing electrosurgery in the procedure.

General

Warning

Always use the lowest output setting necessary that achieves the desired surgical effect. The active electrode should be utilized only for the minimum time necessary in order to lessen the possibility of unintended burn injury. Pediatric applications and/or procedures performed on small anatomic structures may require reduced power settings. The higher the current flow and the longer the current is applied, the greater the possibility of unintended thermal damage to tissue, especially during use on small structures.

Use electrosurgery with caution in the presence of internal or external pacemakers. Interference produced with the use of electrosurgical devices can cause devices such as a pacemaker to enter an asynchronous mode or can block the pacemaker entirely. Consult the pacemaker manufacturer or hospital cardiology department for further information when use of electrosurgical appliances is planned in patients with cardiac pacemakers.

Valleylab recommends against the use of laparoscopic surgery on pregnant patients.

Do not use electrosurgical equipment unless properly trained to use it in the specific procedure being undertaken. Use by physicians without such training has resulted in serious, unintended patient injury, including bowel perforation and unintended, irreversible tissue necrosis.

Hazardous Electrical Output: This equipment is for use only by trained, licensed physicians.

Caution

This equipment is capable of producing a physiological effect.

Read the warnings, cautions, and instructions provided with this generator before using.

For surgical procedures where the current could flow through delicate parts of the body, the use of bipolar techniques may be desirable in order to avoid unwanted coagulation.

Fire/Explosion

Danger

Explosion Hazard: Do not use in the presence of flammable anesthetics.

Warning

Fire/Explosion Hazard: The following substances will contribute to increased fire and explosion hazards in the operating room:

- flammable substances (such as alcohol based skin prepping agents and tinctures)
- naturally occurring flammable gases which may accumulate in body cavities such as the bowel
- oxygen enriched atmospheres
- oxidizing agents (such as nitrous oxide [N₂O] atmospheres)

The sparking and heating associated with electrosurgery can provide an ignition source. Observe fire precautions at all times. When using electrosurgery in the same room with any of these substances or gases, prevent their accumulation or pooling under surgical drapes, or within the area where electrosurgery is performed.

Fire Hazard with Oxygen Circuit Connections**Warning**

Fire/Explosion Hazard: Verify that all oxygen circuit connections are leak free before and during the use of electrosurgery. Verify that endotracheal tubes are leak free, and that the cuff is properly sealed to prevent oxygen leaks. Enriched oxygen atmospheres may result in fires and burns to patients or surgical team.

Electrosurgical Smoke**Caution**

Studies have shown that smoke generated during electrosurgical procedures can be potentially harmful to patients and the surgical team. These studies recommend adequately ventilating the smoke by using a surgical smoke evacuator or other means.¹

1. U.S. Department of Health and Human Services. National Institute for Occupational Safety and Health (NIOSH). *Control of Smoke from Laser/Electric Surgical Procedures. HAZARD CONTROLS, Publication No. 96-128, September, 1996.*

Inadvertent Radio Frequency (RF) Burns**Warning**

Electrodes and probes used with monitoring, stimulation, and imaging devices (or similar equipment) can provide a path for high frequency current even if the electrodes or probes are isolated at 50-60 Hz, insulated, and/or battery operated.

To reduce the risk of an inadvertent electrosurgical burn at the electrode or probe site, place the electrode/probe as far away as possible from the electrosurgical site and/or patient return electrode. Protective impedances (resistors or RF inductors) installed in the monitoring leads may reduce the risk of such burns. Consult the hospital biomedical engineer for further information.

Warning

Do not use needles as monitoring electrodes during electrosurgical procedures. Inadvertent electrosurgical burns may result.

In some circumstances, potential exists for alternate site burns at points of skin contact (e.g., between the arm and the side of the body). This occurs when electrosurgical current seeks a path to the patient return electrode which includes the skin to skin contact point. Current passing through small skin to skin contact points is concentrated and may cause a burn. This is true for grounded, ground referenced, and isolated generators.

To reduce the potential for alternate site burns, do one or more of the following:

- Avoid skin to skin contact points, such as fingers touching the leg, when positioning the patient.
- Place two to three inches of dry gauze to ensure that contact does not occur.
- Position the patient return electrode to provide a direct current route between the surgical site and the return electrode which avoids skin to skin contact areas.
- In addition, place patient return electrodes according to the manufacturer's instructions.

Potential for alternate site burns increases if the return electrode is compromised. Valleylab recommends the use of REM patient return electrodes and Valleylab generators with the REM System.

Ensure Proper Connections

Caution

Examine all accessories and connections to the electrosurgical generator before using. Ensure that the accessories function as intended. Improper connection may result in arcs and sparks, accessory malfunction, or unintended surgical effects.

Active Accessories

Warning

Do not wrap the accessory cords or patient return electrode cords around metal objects. This may induce currents that could lead to shocks, fires, or injury to the patient or surgical team.

Servicing

Caution

Electrical Shock Hazard: Do not remove cover. Refer to authorized personnel for service.

Notice

Refer to the service manual for maintenance recommendations and function and output power verification procedures.

Before Surgery

Active Accessories

Warning

Electric Shock Hazard: Do not connect wet accessories to the generator.

Electric Shock Hazard: Ensure that all accessories and adapters are correctly connected and that no metal is exposed.

Caution

Read the instructions, warnings, and cautions provided with the electrosurgical accessories before using. Specific instructions are not included in this manual.

Connect accessories to the proper receptacle type. In particular, bipolar accessories must be connected to the Bipolar receptacle only. Improper connection of accessories may result in inadvertent generator activation or a REM alarm.

Set power levels to the lowest setting before testing an accessory.

Inspect accessories and cords (especially reusable accessories and cords) for breaks, cracks, nicks, and other damage before every use. If damaged, do not use. Failure to observe this precaution may result in injury or electrical shock to the patient or surgical team.

Do not reuse or resterilize accessories labeled "disposable" or "single use only."

Patient Return Electrodes

Valleylab recommends the use of REM patient return electrodes and Valleylab generators with the REM system.

Warning

The safe use of monopolar electrosurgery requires proper placement of the patient return electrode. To avoid electrosurgical burns beneath the patient return electrode, follow all directions on the product package for proper return electrode placement and use.

Do not cut a patient return electrode to reduce size. Patient burns due to high current density may result.

Do not apply a patient return electrode if only bipolar accessories are being used. Otherwise, the electrosurgical effect may not be limited to the tissue between the bipolar electrodes.

Using a conventional patient return electrode without the REM safety feature will not activate the Valleylab REM Contact Quality Monitoring System.

Warning

Some surgical instruments (e.g., colonoscopes) may allow substantial leakage current which could burn the surgeon. If the instrument manufacturer recommends the use of a shunt cord (s-cord) to direct the current back to the generator, you must also use a Valleylab E0507-B adapter. To avoid a REM alarm, you must use a REM patient return electrode with the E0507-B adapter.

Generator

Warning

Electric Shock Hazard: Connect the generator power cord to a properly grounded receptacle. Do not use power plug adapters.

Fire Hazard: Do not use extension cords.

The instrument receptacles on this generator are designed to accept only one instrument at a time. Do not attempt to connect more than one instrument at a time into a given receptacle. Doing so will cause simultaneous activation of the instruments.

Caution

Do not stack equipment on top of the generator or place the generator on top of electrical equipment. This is an unstable configuration and does not allow for adequate cooling.

When using a smoke evacuator in conjunction with the electrosurgical generator, place the smoke evacuator a distance from the generator and set the generator volume control at a level that ensures that the activation tones can be heard.

Provide as much distance as possible between the electrosurgical generator and other electronic equipment (such as monitors). An activated electrosurgical generator may cause interference with them.

Do not turn the activation tone down to an inaudible level. The activation tone alerts personnel when an accessory is active.

Nonfunction of the generator may cause interruption of surgery. A backup generator should be available for use.

Notice

If required by local codes, connect the generator to the hospital equalization connector with an equipotential cable.

Connect the power cord to a wall receptacle having the correct voltage. Otherwise, product damage may result.

During Surgery

Contact with Metal Objects

Warning

- Contact of the active electrode with any metal will greatly increase current flow and can result in unintended surgical effect.
- While using electrosurgery, the patient should not be allowed to come into direct contact with grounded metal objects (e.g., surgical table frame, instrument table, etc.). If this is not possible during certain procedures (e.g., those in which noninsulated head frames are used), use extreme caution to maximize patient safety:
 - Use the lowest power setting that achieves the desired effect.
 - Place the patient return electrode as close to the surgical site as possible.
 - Place dry gauze between the patient and the grounded object if possible.
 - Continually monitor the contact point(s).

Generator Power Settings

Warning

Confirm proper power settings before proceeding with surgery. Use the lowest power setting possible for the minimum time necessary to achieve the desired effect.

Never increase the power settings without first checking both the active electrode and the patient return electrode and their connections. Use the active electrode or forceps only for the minimum time necessary to achieve the desired surgical effect in order to minimize the possibility of burns. This is especially true in pediatric and neonatal patients or in any patient where small structures are involved.

Caution

If the proper settings are not known, set the electrosurgical generator at a very low setting and cautiously increase the power until the desired effect is achieved.

Forceps

Notice

Do not activate the generator until the forceps have made contact with the patient. Product damage may occur.

Suction Coagulators

Warning

To avoid the possibility of a burn to the surgeon, always place the generator in the standby mode prior to bending or reshaping the coagulator suction tube.

Warning

Ensure that the outside of the coagulator suction tube remains free of blood and mucus. Failure to clean the coagulator suction tube can allow electrical conductance by means of the contaminants which may result in patient burns.

Do not immerse the suction coagulator handswitch mechanism in saline solution or other conductive fluids. Unintended activation may result.

Active Accessories

Warning

Do not place active accessories near or in contact with flammable materials (such as gauze or surgical drapes). Electrosurgical accessories that are activated or hot from use can cause a fire. Use a holster to hold electrosurgical accessories safely away from patients, the surgical team, and flammable materials.

Simultaneously activating suction/irrigation and electrosurgical current may result in increased arcing at the electrode tip, burns to unintended tissues, or shocks and burns to the surgical team.

Some surgeons may elect to “buzz the hemostat” during surgical procedures. It is not recommended, and the hazards of such a practice probably cannot be eliminated. Burns to the surgeon’s hands are possible. To minimize the risk:

- Do not lean on the patient, the table, or the retractors while buzzing the hemostat.
- Activate cut rather than coag. Cut has a lower voltage than coag.
- Use the lowest power setting possible for the minimum time necessary to achieve hemostasis.
- Activate the generator after the accessory makes contact with the hemostat. Do not arc to the hemostat.
- Firmly grasp as much of the hemostat as possible before activating the generator. This disperses the current over a larger area and minimizes the current concentration at the finger tips.
- “Buzz the hemostat” below hand level (as close as possible to the patient) to reduce the opportunity for current to follow alternate paths through the surgeon’s hands.
- When using a stainless steel blade electrode, place the **flat** surface against the hemostat or other metal instrument.
- When using a coated or nonstick blade electrode, place the **edge** of the electrode against the hemostat or other metal instrument.

When not using active accessories, place them in a holster or in a clean, dry, nonconductive, and highly visible area not in contact with the patient. Inadvertent contact with the patient may result in burns.

Caution

Studies have shown that smoke generated during electrosurgical procedures can be potentially harmful to surgical personnel. These studies recommend using surgical masks and ventilating the smoke by using a surgical smoke evacuator or other means.

Patient Return Electrodes

Warning

To avoid patient burns, ensure that the patient return electrode firmly contacts the skin. Always check the patient return electrode periodically after the patient is repositioned and during procedures involving long periods of activation.

Laparoscopic Procedures

Warning

For laparoscopic procedures be alert to these potential hazards:

- Laparoscopic surgery may result in gas embolism due to insufflation of gas into the abdomen.
- The electrode tip may remain hot enough to cause burns after the electrosurgical current is deactivated.
- Inadvertent activation or movement of the activated electrode outside of the field of vision may result in injury to the patient.
- Localized burns to the patient or physician may result from electrical currents carried through conductive objects (such as cannulas or scopes). Electrical current may be generated in conductive objects by direct contact with the active electrode, or by the active accessory (electrode or cable) being in close proximity to the conductive object.
- Do not use hybrid trocars that are comprised of both metal and plastic components. For the operative channel, use all metal or all plastic systems. At no time should electrical energy pass through hybrid systems. Capacitive coupling of RF current may cause unintended burns.
- When using laparoscopic instrumentation with metal cannulas, the potential exists for abdominal wall burns to occur due to direct electrode contact with or capacitive coupling of RF current. This is most likely to occur in instances where the electrosurgical generator is activated for extended periods at high power levels and induced high current levels in the cannula.
- Ensure that the insulation of single use and reusable laparoscopic instrumentation is intact and uncompromised. Compromised insulation may lead to inadvertent metal to metal sparking and neuromuscular stimulation and/or inadvertent sparking to adjacent tissue.
- Do not activate electrodes while in contact with other instruments as unintended tissue injury may occur.
- Do not activate the generator in an open circuit condition. Activate the generator only when the active electrode is near or in direct contact with the target tissue to lessen the possibility of creating unintended burns.
- Use the lowest power setting that achieves the desired surgical effect and use a low voltage waveform (cut mode) to lessen the potential for the creation of capacitive currents.
- Carefully insert and withdraw active electrodes from cannulas to avoid possible damage to the devices and/or injury to the patient.

After Surgery

Warning

Electric Shock Hazard: Always turn off and unplug the generator before cleaning.

Caution

Do not reuse or resterilize accessories labeled "disposable" or "single use only."

Notice

Do not clean the generator with abrasive cleaning or disinfectant compounds, solvents, or other materials that could scratch the panels or damage the generator.



Installation

This section describes how to install the Force 2 Generator.

Inspect the Generator

Inspect the generator for any signs of physical damage to the control panel, base assembly and cover. Perform functional tests as specified in the "Testing and Calibration" Section of the service manual. If physical damage is found or the electrosurgical generator does not perform within specifications, file a claim with the carrier. All returns must have approval from Valleylab.

Responsibility of the Manufacturer

Valleylab is responsible for safety, reliability, and performance of the equipment only if:

- installation procedures in this manual are followed
- assembly operations, extensions, re-adjustments, modifications or repairs are carried out by persons authorized by Valleylab
- electrical installation of the relevant room complies with local codes and regulatory requirements such as IEC and BSI
- equipment is used in accordance with the Valleylab instructions for use

Preparing the Generator for Use

The electrosurgical generator may be placed on a mounting cart available from Valleylab or on any sturdy table or platform. It is recommended that carts have conductive wheels. Refer to hospital procedures or local codes for detailed information.

Provide at least four to six inches of space around the sides and top of the generator for convection cooling. Under continuous use for extended periods of time, it is normal for the top and rear panel to be warm.

Refer to the MedGV Supplement in this manual for specific MedGV requirements.

Danger

Explosion Hazard: Do not use in the presence of flammable anesthetics.

Power Requirements

The Force 2-2 PCH Electrosurgical Generator is designed to operate at 110-120 Vac nominal, 50-60 Hz.

The Force 2-8 PCH Electrosurgical Generator is designed to operate at 220-240 Vac nominal, 50-60 Hz.

Check the Power Connector

The Force 2 generator is supplied with a hospital grade power cord and a three-prong power connector. If using the generator in an operating room with another type of receptacle:

- International Only – The Valleylab representative in your country will equip your generator with the proper power cord for your country.
- Domestic Only – The hospital is responsible for replacing the connector on the power cord.

The power connector meets all requirements for safe grounding. Its purpose should not be defeated by using extension cords or three-prong to two-prong adapters. Periodically check the power cord assembly for damaged insulation or connectors. Always grasp cords by the connector. Do not pull on the cord itself.

Ensure Proper Grounding

► Important

It is the user's responsibility to ensure that the electrical installation of the relevant room complies with local codes and regulatory requirements such as IEC and BSI.

To ensure patient safety, the Force 2 generator must be properly grounded.

The ground wire in the power cord connects to the unit chassis and ensures that no dangerous currents flow from the unit in the event of internal electrical failure. Do not use extension cords or three-prong or two-prong electrical adapters.

Undesirable leakage currents are affected by the polarization of the 50-60 Hz input power. It is the responsibility of the user to ensure proper polarity and grounding of the power outlets supplying power to the unit.

If required, use the equipotential ground cable supplied with the unit. The equipotential ground connector is located on the rear panel of the generator.

Routine Maintenance

Valleylab recommends that the Force 2 generator be inspected by qualified service personnel once a year. The service manual describes the recommended inspection, testing, and calibration procedures. For major repairs the generator can be returned to Valleylab. Repair parts or information needed to repair the generator may be obtained from Valleylab.

The power cord should be periodically checked for damaged insulation or connectors.

Refer to the MedGV Supplement in this manual for specific MedGV requirements on the Force 2-8 PCH generator.

Cleaning Instructions

Use a mild detergent and damp cloth to clean the generator cover, keyboard, and cord. Do not allow fluids to enter the chassis. Do not use caustic, corrosive, or abrasive cleaning materials. The generator cannot be sterilized.

Notes



Description of Controls, Indicators, and Receptacles

The controls, indicator, and receptacles for accessories are located on the front panel of the Force 2 Unit. This section describes each component of the unit and its function. Detailed procedures for setting up the unit are in Section 4.

PCH Generator Front View

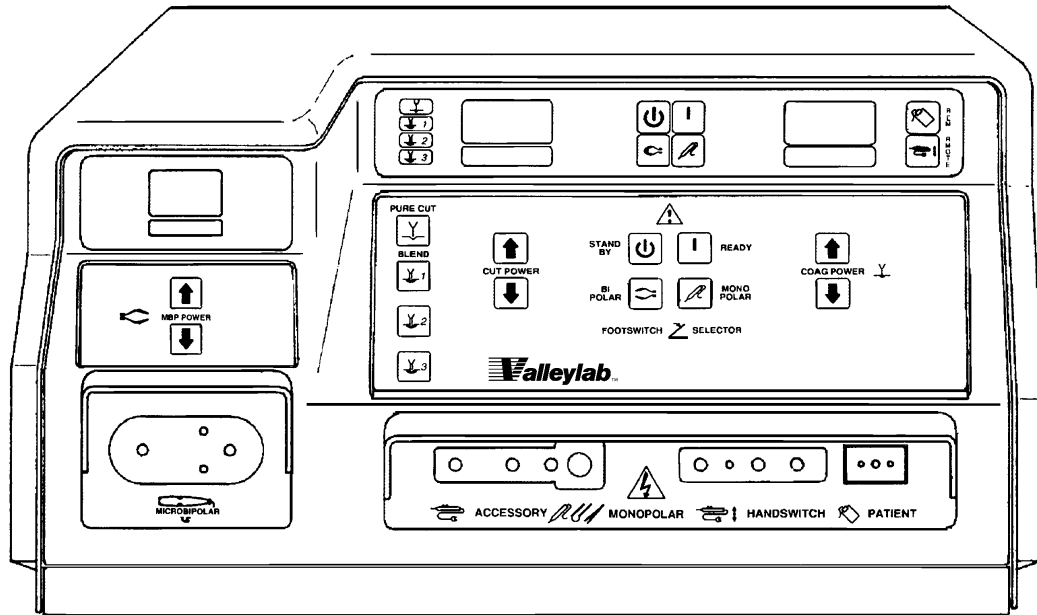

PCH Generator Rear View

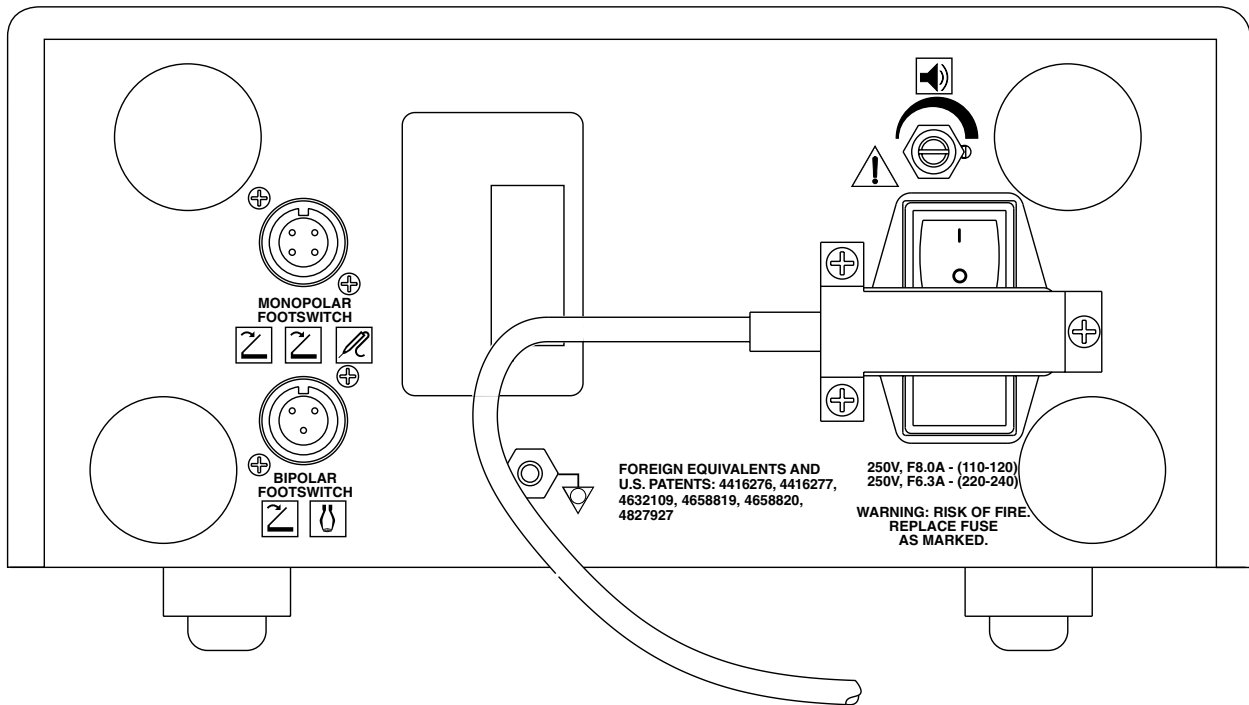

Controls



Standby – Press this button to place the electrosurgical generator in a hold mode. The generator cannot be activated and all audio alarms are silenced. Power settings are retained in memory and the display shows dashes.



Ready – Press this button to place the generator into service with power outputs, displays, and alarms fully functional.



PCH Monopolar – Press this button to select the monopolar footswitch control for activating the *Accessory* receptacle.



Bipolar – Press this button to select the bipolar output when using the monopolar footswitch.



Power Up – Increases power in the selected mode. A single press of the button increases the power setting by one watt. Continuously pressing the button gradually increases the power to maximum.



Power Down – Decreases power in the selected mode. A single press of the button lowers the power setting by one watt. Continuously pressing the button gradually decreases the power to minimum.

PURE CUT



Pure Cut – Press this button to select cut with the lowest level of hemostasis.

BLEND



Blend 1 – Press this button to select cut with minimum hemostasis.



Blend 2 – Press this button to select cut with moderate hemostasis.



Blend 3 – Press this button to select cut with maximum hemostasis.

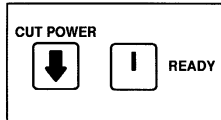

Power Control Pencil Mode – The power control pencil feature does not have a dedicated button to access this mode. Press the *Ready* button and while holding it, press the *Cut Power Down* button. The generator sounds a single tone and the *RMOTE* lamp illuminates.

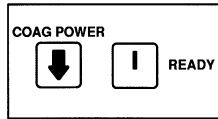

Low Voltage Coag – Low voltage coag does not have a dedicated button to access this mode. Press the *Ready* button and while holding it, press the *Coag Power Down* button. The generator displays an L in the hundreds digit of the coag power setting display.

Indicators



Standby Indicator – Indicates generator is on, but cannot activate outputs.



Ready Indicator – Indicates generator is ready for use.

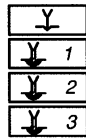

Cut Mode Indicators – One of four cut mode indicators illuminates to show the selected cut mode.



Power Setting Display – The digital power setting display is visible on the generator in the ready mode. The number displayed indicates the nominal power, in watts, which will be delivered to the patient when the mode is activated. In the standby mode dashes are displayed.



Output Power Indicators – The indicator illuminates when that output power (cut, coag, bipolar) activates. One of the two distinct mode indicator tones sound in conjunction with the visual output power indicator.

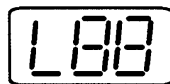

Low Voltage Coag Mode Indicator – An L in the hundreds digit of the coag power setting display indicates that the low voltage coag mode is selected.



Monopolar Indicator – This indicator illuminates when the generator's monopolar footswitch is selected for monopolar accessory activation.



Bipolar Indicator – This indicator illuminates when the generator's monopolar footswitch control is selected to activate the bipolar output.



Remote Indicator – This indicator illuminates and the alarm tone sounds once when the power control feature activates. When this indicator illuminates, power changes can be made using the power control handswitching pencil.

Alarms



REM Alarm Indicator – This indicator illuminates when the REM Contact Quality Monitoring System senses that contact between the patient return electrode and the patient is not adequate. The tone sounds twice when the condition is first detected. The generator does not produce monopolar output power when this alarm condition exists. The alarm condition is cleared when the REM Contact Quality Monitoring System senses that the patient/pad contact resistance is within the acceptance range.

Receptacles

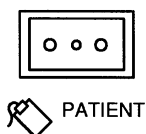

Patient Return Electrode Receptacle – This two-pin receptacle accepts the patient return electrode connector used in monopolar procedures. The receptacle accepts both REM (dual-section) and conventional patient return electrode connectors.

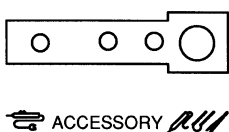

PCH Monopolar Active Receptacle (Accessory) – This receptacle has two output receptacles. It accepts three-pin handswitching active accessories or standard one-pin accessories which can be activated by the monopolar footswitch. Cut and coag modes may be activated at this receptacle. The handswitching pencil can be footswitch activated when connected to this output receptacle.

Warning

The **Accessory** output receptacle is designed for connecting either a handswitch (three-pin) or footswitch (one-pin) accessory, but not both at the same time. Connecting more than one accessory to the **Accessory** output receptacle will activate both accessories simultaneously.

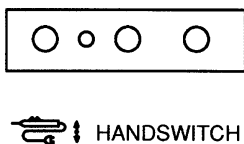

Monopolar Active Receptacle (Handswitch) – This receptacle accepts the three-pin handswitching active accessories and the Valleylab power control pencil. Power output from this receptacle is activated only by using the handswitch mechanism. No power is available through use of the footswitch. Cut and coag modes may be activated at this receptacle. Note: The power control pencil is only functional through this receptacle.

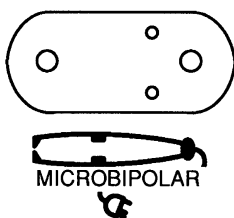

Microbipolar Active Receptacle – This receptacle accepts three-pin handswitching bipolar accessories. These accessories can also be footswitch activated. This receptacle also accepts two-pin bipolar footswitching accessories.

Rear Panel Functions

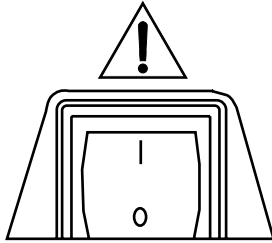

On/Off Switch – Press the toggle upward to turn power on and down to shut power off.

The Force 2 generator uses a universal type power entry module but is not voltage selectable. Line fuse replacement is the following:

250V	8A	110-120V generators (-2 PCH)
250V	6.3A	220-240V generators (-8 PCH)

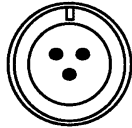

BIPOLAR
FOOTSWITCH



Bipolar Footswitch Receptacle – This three-pin receptacle accepts a single-pedal bipolar footswitch connector.

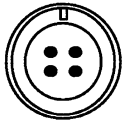

MONOPOLAR
FOOTSWITCH



Monopolar Footswitch Receptacle – This four-pin receptacle accepts a two-pedal monopolar footswitch connector.

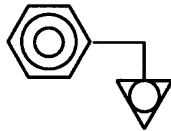

Equipotential Lug – This lug may be connected to earth ground with an equipotential grounding cable.

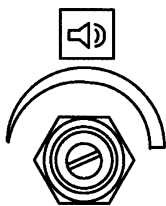

Audio Volume Control – The volume of the cut, coag, and bipolar mode indicator tones produced when the generator is activated may be adjusted with this control. The volume of the audio alarm is not adjustable.



Instructions for Use

This section describes how to set up the unit for surgery.

Setting Up the Force 2 Generator for Surgery

1. Plug the generator into a grounded receptacle. Do not use extension cords and/or adapter plugs.

Simultaneously using two generators – Do not stack the generators or place them too close together to allow for adequate cooling.

2. Turn on the power using the rear panel On/Off switch.

Ensure the generator performs a self-check. Verify that 8s and then dashes appear on the displays. The generator is then in the standby mode. If any of the indicators do not illuminate, contact your Biomedical Department.

3. If necessary, connect the footswitch to the generator rear panel.

You can connect a Valleylab monopolar two-pedal footswitch and/or a bipolar single-pedal footswitch to the generator rear panel. Connect the monopolar footswitch to the *Monopolar Footswitch* receptacle. Connect the bipolar footswitch to the *Bipolar Footswitch* receptacle.

4. If necessary, apply the patient return electrode to the patient.

Follow the instructions supplied with the patient return electrode to properly apply the return electrode to the patient.

Warning

Using a patient return electrode without the REM safety feature will not activate the Valleylab REM Contact Quality Monitoring System.

Monopolar electrosurgery – Always apply a patient return electrode to the patient for monopolar electrosurgery.

Microbipolar electrosurgery only – Do not apply a patient return electrode if you plan to use microbipolar electrosurgery only. If you connect bipolar forceps to the Microbipolar receptacle and activate the forceps, the REM indicator illuminates. You can use the bipolar forceps with the REM indicator illuminated.

When a shunt cord (s-cord) will be used – Some surgical instruments (e.g., colonoscopes) have capacitance to ground which allow substantial leakage current. To safely shunt the current to the generator, use a shunt cord that requires a special Valleylab adapter, and use a REM patient return electrode.

Capacitive pads – Do not use capacitive pads because of the potential of high impedance at the patient and return pad interface.

Simultaneously using two generators – If you are using two generators simultaneously on the same patient, frequently one patient return electrode has a high positive voltage and the other has an opposite negative voltage. When this occurs, a voltage potential difference exists between the patient return electrodes, and the current may flow to one patient return electrode instead of flowing to both patient return electrodes. To avoid problems, place the patient return electrode as close as possible to the site of surgery and to the generator to which it connects. Ensure that the two patient return electrodes are not touching.

5. Connect the patient return electrode to the generator.

6. Select the power levels and modes.

Select the output and then use the *Up* and *Down* buttons to select the desired power setting.

7. Connect the electrosurgical accessories to the appropriate receptacles.

Refer to the instructions for use provided with the accessory before using.

Warning

The **Accessory** receptacle is designed for connecting either a handswitch (three-pin) or footswitch (one-pin) accessory, but not both at the same time. Connecting more than one accessory to the **Accessory** receptacle will activate both accessories simultaneously.

Handswitching pencils – connect to the **Monopolar Handswitching** or **Monopolar Accessory** receptacle.

Monopolar handswitching forceps – connect to the **Monopolar Handswitching** or **Monopolar Accessory** receptacle.

Power control pencils – connect to the **Monopolar Handswitching** receptacle.

Bipolar handswitching forceps – connect to the **Microbipolar** receptacle.

Monopolar footswitching accessories (e.g., endoscopes, forceps, or chuckhandles) – connect to the **Monopolar Accessory** receptacle.

Bipolar footswitching forceps – connect to the **Microbipolar** receptacle.

8. Press the *Standby* button to prevent inadvertent activation.

Dashes appear on the power setting display, and all the settings are retained in memory.

When the surgeon is ready to use the generator:

- A. Press the **Ready** button.
- B. Press the handswitch or footswitch to activate the generator.

Common Generator/Accessory Setups

Microbipolar Output

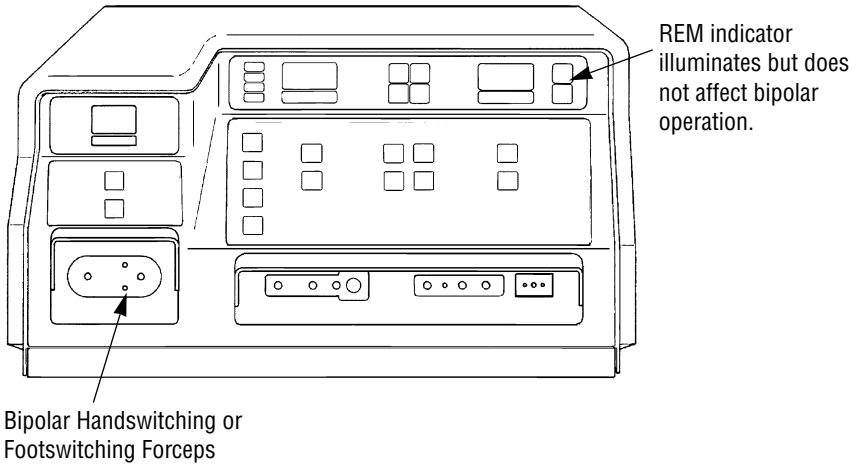

Monopolar Handswitching Output

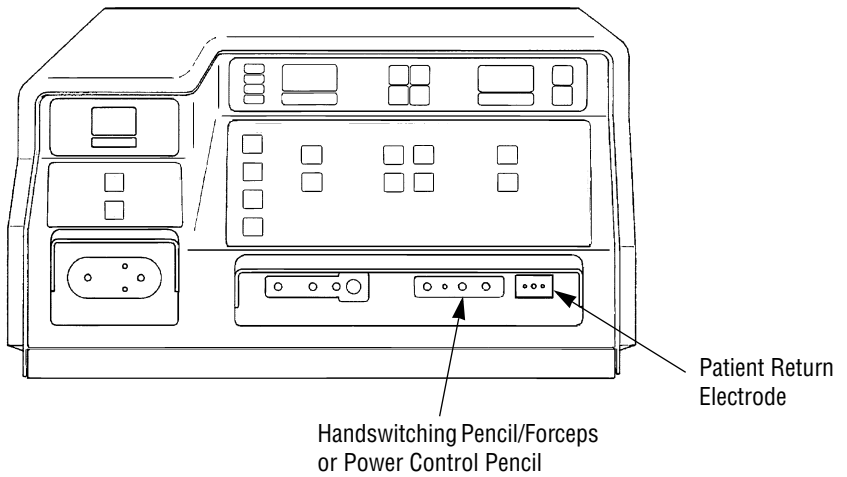

Simultaneous Coag

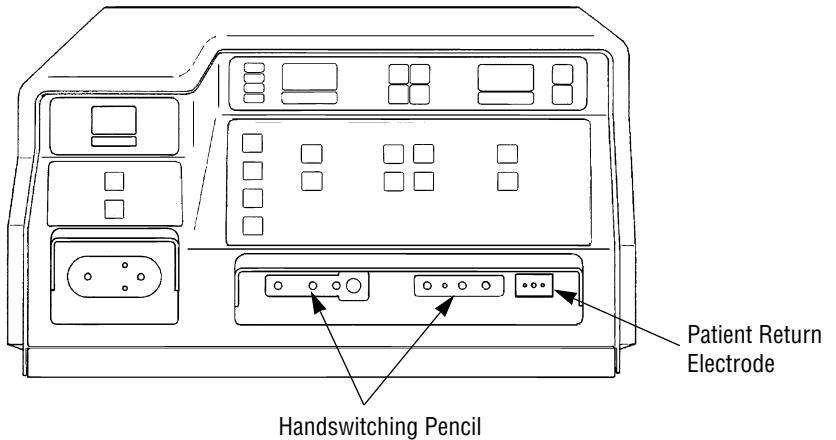

Monopolar and Bipolar Setup

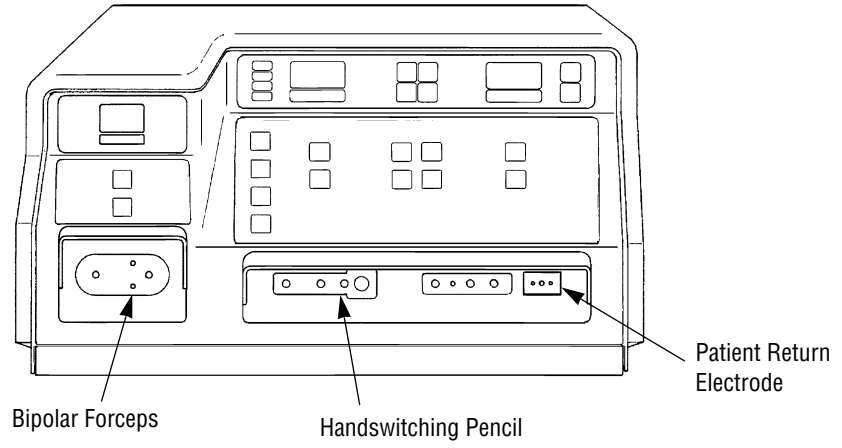

Monopolar Footswitching Output

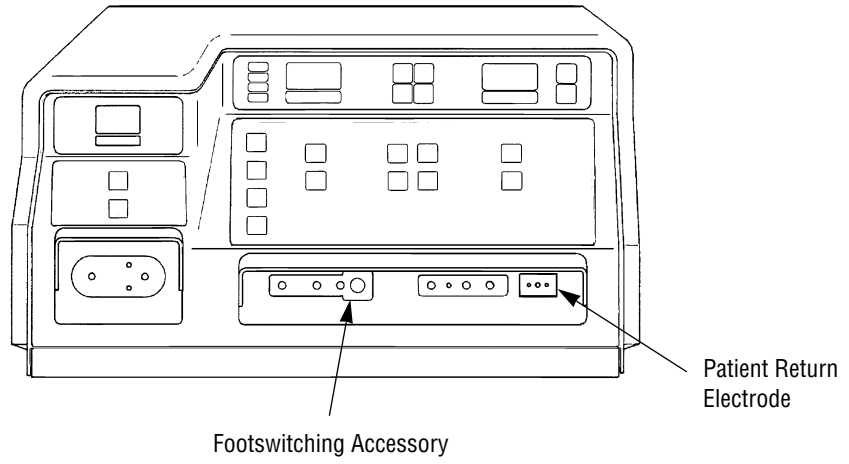

During Surgery

Monopolar Electrosurgery

Monopolar electrosurgery includes cutting, fulguration, and desiccation. Cutting and fulguration involve sparking across an air gap to tissue. Desiccation puts the greatest demand on the patient return electrode during monopolar electrosurgery because the active electrode directly touches the tissue, and more current reaches the patient since it does not have to overcome the high impedance of air. Fulguration can cause accidental sparking to adjacent areas as the tissue at the surgical site dries and becomes more resistant.

Microbipolar Electrosurgery

Microbipolar systems provide desiccation and minimize damage to tissues adjacent to the surgical site by incorporating the active and return electrodes in the same device. This limits the amount of tissue in the electrosurgical circuit. Microbipolar output provides the following advantages over monopolar output:

- limited collateral tissue damage
- reduced electromagnetic interference with both video and other monitoring equipment
- reduced capacitive coupling

Microbipolar procedures may therefore be performed in confined surgical sites where high levels of precision and control are required.

Recommendations During Surgery

Refer to Section 1, *Patient and Operating Room Safety* for further information.

Keep the power settings as low as possible to enhance patient safety.

If higher than normal power settings are required, check the patient return electrode and the generator connecting cables for proper application and/or continuity.

Remove eschar buildup from electrodes to maximize surgical effect.

Avoid unnecessary and prolonged activation of the generator to reduce the possibility of alternate site burns that may be caused by RF leakage currents.

When using multiple accessories, keep the cables separate. To reduce cross coupling, do not twist, bundle, or clamp the cables together.

Typical Power Settings

The power level used for various surgical procedures varies considerably with the surgeon's technique and the size of the active electrode. A needle electrode requires less power to sustain a spark than a large ball electrode.

One surgeon may perform a procedure by electrosurgically severing tissue with a cutting or blended waveform while another surgeon might perform the same procedure by using a coag waveform at a lower power level.

A general outline of typical power settings for various surgical procedures:

Low Power – Under 30W

- Neurosurgery (both bipolar and monopolar)
- Laparoscopic sterilization (both monopolar and bipolar)
- Vasectomies
- Dermatology
- Oral surgery
- Plastic surgery

Medium Power – coag 30W to 70W, cut 30W to 150W

- General surgery
- Laparotomies
- Head and neck surgery (ENT)
- Major orthopedic surgery
- Major vascular surgery
- Routine thoracic surgery
- Polypectomy

High Power – coag over 70W, cut over 150W

- Thoracotomies (heavy fulguration, 70W to 75W)
- Ablative cancer surgery, mastectomies, etc. (cut 180W to 200W; coag 70W to 75W).

If the proper setting is not known from personal experience, one should set the generator at a very low setting and cautiously increase power until the desired effect is achieved.

Low Power Settings

The higher the power setting and the longer the activation time a surgical procedure requires, the greater risk it poses for electrosurgical burns. Keeping the power settings as low as possible during all electrosurgical procedures minimizes the hazards by reducing the amount of current delivered to the patient and reducing the demand placed on the patient return electrode.

The following techniques keep power settings low during electrosurgery:

- Concentrate the current with a small active electrode. A needle electrode can often cut as well as a blade, but at lower power settings.
- Use fulguration rather than desiccation to coagulate tissue. Although fulguration sparks to tissue using a high voltage waveform, it can coagulate tissue with less current and put less demand on the return electrode.
- Cut by sparking tissue and not desiccating tissue. Sparking cuts cleanly and quickly and delivers less current to the patient than desiccation.
- Use bipolar output because it requires less power and limits the amount of tissue involved in the electrosurgical circuit.

Low Voltage Coag

Low voltage coag is primarily designed for use with monopolar desiccation. Output power is limited to 99 W at a reduced voltage.

To activate low voltage coag, press and hold the **Ready** button, and press the **Coag Power Down** button on the front panel. The generator responds by displaying an “L” in the hundred's digit of the coag power setting display.

To change the coag mode once low voltage coag has been activated:

Hold the **Ready** button and press the **Coag Power Down** button, just as low voltage coag was activated originally.

The “L” in the coag power setting display disappears, signalling that the coag mode with the higher voltage (high crest factor) is set for fulguration.

Changing Power Settings

When the surgeon activates the Force 2 generator, you cannot change the power settings. To change a power setting after the surgeon discontinues activation, press the appropriate Up or Down buttons until the desired setting appears on the power display.

Remote Power Changes Using the Valleylab Power Control Pencil

If a Valleylab power control pencil is used, the surgeon can control the power settings by pressing the Up or Down buttons located on the pencil.

To activate the pencil power control feature, press the ***Ready*** button and the ***Cut Power Down*** button simultaneously on the generator front panel. The generator responds by sounding a single tone and the ***RMOTE*** indicator illuminates.

Press the + or - buttons on the pencil to increase or decrease the power of the last used mode (cut or coag). Press and release the appropriate button to increase/decrease the power setting by one power setting unit. Each time the power setting is changed from the pencil, a tone sounds and the power setting display indicates the new power setting. The power control pencil will not change power settings while the generator is activated in any mode.

The power control feature can be deactivated by placing the generator in standby and then back to ready. Power will return to the last displayed power setting.

Activating Accessories

Warning

When not using active accessories, place them in a holster or in a clean, dry, nonconductive, and highly visible area not in contact with the patient. Inadvertent contact with the patient may result in burns.

Fire Hazard: Do not place active accessories near or in contact with flammable materials (such as gauze or surgical drapes). Electrosurgical accessories that are activated or hot from use can cause a fire. Use a holster to hold electrosurgical accessories safely away from patients, the surgical team, and flammable materials.

Handswitching pencils – activate by pressing either the handswitch cut or coag button.

Monopolar handswitching forceps (for coagulation only) – activate by closing the forceps tines.

Bipolar handswitching forceps (for coagulation only) – activate by closing the forceps tines.

Monopolar footswitching accessories (e.g., endoscopes, forceps, or chuckhandles) – activate by pressing the appropriate pedal on the monopolar footswitch.

Bipolar footswitching forceps – activate by pressing the bipolar footswitch pedal or activate by pressing either monopolar footswitch pedal with the front panel footswitch selector in the bipolar mode.

Caution

Do not activate the generator until the forceps have made contact with the patient. Product damage may occur.

Operating Room Troubleshooting

This section describes operating room troubleshooting.

REM Alarm (two tones)

Conventional (single-section) Patient Return Electrode

1. Inspect the plug, cord, and patient return electrode for excessive wear or visible damage. Replace if necessary.
2. If a REM alarm persists, use a backup generator.

REM (dual-section) Patient Return Electrode

1. Inspect the patient return electrode plug.
 - a. Leave the generator in the ready mode.
 - b. Unplug the patient return electrode from the *Patient* receptacle of the generator.
 - c. Inspect the plug pin to ensure it is not bent or missing.
 - d. Carefully reinsert the plug into the *Patient* receptacle.
 - e. Ensure that the pin goes into the hole and that the plug fully inserts.
 - f. If the alarm condition is not corrected, proceed to step 2.

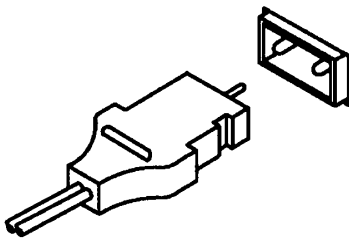

2. Inspect the patient REM pad. Do not remove the pad.
 - a. Apply firm pressure over the entire surface area of the patient return electrode, particularly the center.
 - b. If the REM alarm persists, place the generator in the standby mode.
 - c. Unplug the patient return electrode from the generator. Do not remove the return electrode pad from the patient.
 - d. Proceed to step 3.

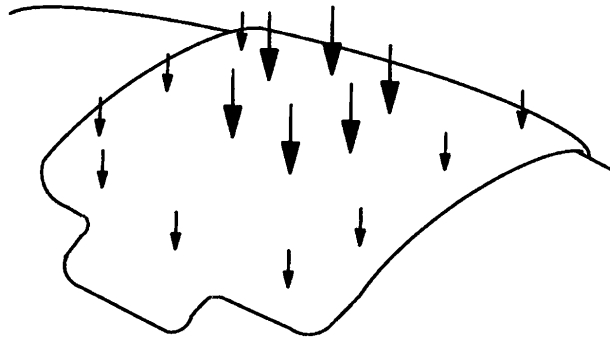

3. Apply a second patient REM pad.
 - a. Apply a second REM electrode to the patient's thigh, upper biceps, calf, or lower back.
 - b. Place the generator in the ready mode.
 - c. Connect the return electrode to the generator.
 - d. If the alarm condition is not corrected, place the generator in the standby mode.
 - e. Unplug the patient return electrode from the generator. Do not remove the return electrode from the patient.
 - f. Proceed to step 4 or 5.

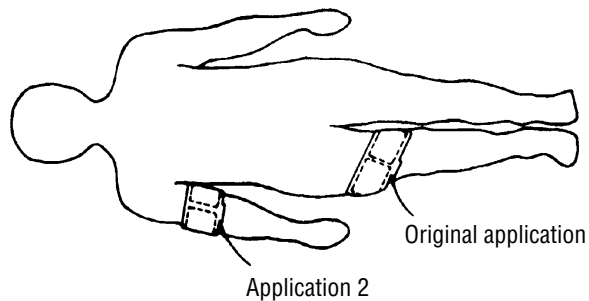

4. Apply a third patient REM pad.
 - a. Apply a third return electrode to the patient, selecting the next best, well vascularized, convex area close to the surgical site.
 - b. Place the generator in the ready mode.
 - c. Connect the plug of the return electrode to the generator.
 - d. If the REM alarm has not been cleared, place the generator in the standby mode.
 - e. Unplug the patient return electrode from the generator.
 - f. Proceed with step 5.

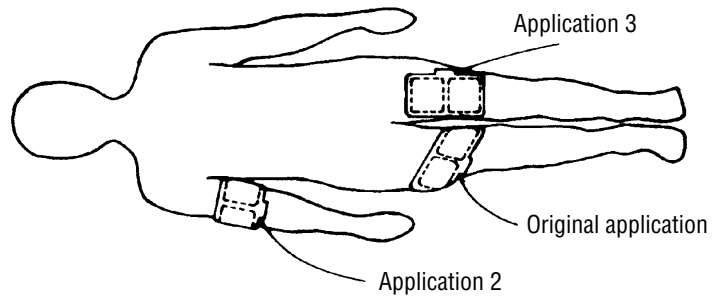

5. Use a Multiple Return Adapter.
 - a. Insert a Valleylab Multiple Return Adapter into the *Patient* receptacle.
 - b. Place the generator in the ready mode.
 - c. Insert the plugs of two patient return electrodes which have already been applied into the adapter. Choose the two return electrodes which are on the most vascularized, convex areas, in closest proximity to the surgical site.

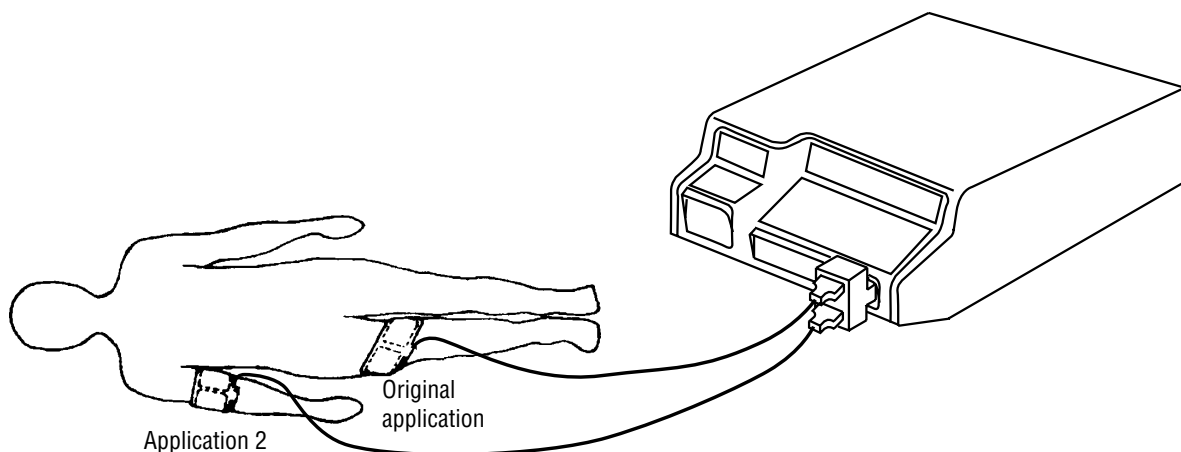

6. If the REM alarm cannot be cleared by these procedures, use a backup generator and repeat steps 1 through 5.
7. Once the REM alarm clears, leave the generator in the ready mode during draping to avoid disturbing the return electrode(s).
8. Remove any return electrodes which are not in use.

No Output

1. Generator not plugged in.
2. Generator not turned on.
3. Malfunction in accessory or footswitch.
4. Patient return electrode not in contact with patient.
5. Patient return electrode not connected to generator.
6. Broken patient return electrode cord.
7. An alarm condition exists.
8. Power set too low.
9. An internal generator failure; use backup generator.

Monitor Interference

Continuous Interference

1. Check the chassis ground connections for both monitor and generator.
2. Check all other electrical equipment in the operating room for defective grounds.
3. If the electrical equipment is grounded to different objects, rather than a common ground, voltage differences can appear between the two grounded objects. The monitor may respond to these voltages. Some types of input amplifiers can be balanced to achieve optimal common mode rejection and may correct the problem.

Interference Only when Generator is Activated

1. Check all connections to the generator, patient return electrode, and active accessory to look for possible metal-to-metal sparking.
2. Interference is usually greatest during fulguration. The amount of interference can be reduced by using lower power settings or using a lower voltage (low voltage coag or cut).
3. If interference continues when the generator is activated and while the active electrode is not in contact with the patient, the monitor is responding to radio frequencies. Some manufacturers offer RF choke

filters for use in the monitor leads. These filters reduce interference while the generator is activated. RF filters minimize the potential for an electrosurgical burn at the site of the monitor electrode.

4. Check that the ground wires in the operating room are electrically consistent. All ground wires should go to the same grounded metal with wires that are as short as possible.
5. If the above steps do not remedy the situation, the generator should be checked by qualified service personnel.

Neuromuscular Stimulation

1. Stop the surgery.
2. Check all connections to the generator, patient return electrode, and active electrodes to look for a possible metal-to-metal spark.
3. Lowering the power setting or using a lower voltage (low voltage coag or cut) may alleviate the problem. Neuromuscular stimulation is more likely to occur in the coag mode when fulgurating than when cutting, and is unlikely when desiccating.
4. If no problems are found, the generator should be checked by qualified service personnel for abnormal 50-60 Hz AC leakage currents.

Pacemaker Interference

1. Check all connections of both active and patient return electrode cords to ensure that there is no intermittent or metal-to-metal sparking.
2. Use bipolar instruments if possible.
3. If monopolar instruments must be used, place the patient return electrode as close as possible to the site of surgery and make sure that the current path from the site of surgery to the patient return electrode does not pass through the vicinity of the heart.
4. Always monitor pacemaker patients during surgery.
5. Always keep a defibrillator available during electrosurgery on patients with pacemakers.
6. Consult the pacemaker manufacturer for specific recommendations.

Notes

The REM Contact Quality Monitoring System

This section describes the REM Contact Quality Monitoring System.

The REM Contact Quality Monitoring System ensures adequate patient contact area by measuring the resistance between the two sections of the REM patient return electrode through the patient. Both sections of the pad and both connector pins carry the RF currents back to the generator. The pin to pin resistance measurement is performed continuously, even when the generator is activated. The measurement uses small currents at 140 kHz and will not produce nerve stimulation or interfere with ECG monitors. The alarm levels have acceptance ranges so that small changes in resistance will not cause intermittent alarms.

The REM contact quality monitor is activated when a REM patient return electrode connector is inserted in the Patient receptacle.

The REM contact quality monitor alarms and disables the monopolar output under the following conditions:

- The patient return electrode is not plugged into the generator.
- A patient return electrode cord is broken.
- The patient return electrode is not in contact with patient.
- There is a reduction of patient return electrode contact area due to movement, loss of adhesion, or drying of contact gel.
- There is excessive impedance in the patient return electrode cord.

If a conventional, single-section patient return electrode is used, the REM system monitors the pin to pin resistance at the connector and is capable of detecting broken wires or connectors in the patient return electrode cord.

The REM contact quality monitor is not able to monitor the patient contact area if conventional, single-section patient return electrodes are used.

Adaptive REM Monitoring

After the patient return electrode is applied and the initial impedance is between 5 ohms and 135 ohms, the “adaptive” REM system measures the contact impedance and uses it as a reference value. If the patient-to-pad impedance increases 40% above this reference value or above 135 ohms, the REM alarm sounds and the monopolar output is disabled. The adaptive REM system is designed to calibrate itself with respect to each patient.

Technical Specifications

In this section “typical” refers to a specification that is within 20% of a stated value. Specifications subject to change without notice.

Standard Conditions of Measurement

Unless otherwise indicated, all measurements are specified at an ambient temperature of 21 degrees C (70 degrees F) and 760 torr.

Operating Parameters

Temperature Range	10° C (50° F) to 40° C (104° F)
Humidity Range	30% to 75%, noncondensing
Atmospheric Pressure	500 to 1060 millibar

Storage and Shipping

Temperature Range	-18°C (0° F) to 70° C (158° F)
Humidity Range	10% to 100%, noncondensing
Atmospheric Pressure	500 to 2500 millibar

Output Waveform

Cut	510 kHz sinusoid
Blend 1	510 kHz bursts of sinusoid at 50% duty cycle recurring at 31 kHz
Blend 2	510 kHz bursts of sinusoid at 37.5% duty cycle recurring at 31 kHz
Blend 3	510 kHz bursts of sinusoid at 25% duty cycle recurring at 31 kHz
Coag	510 kHz damped sinusoidal bursts with a repetition frequency of 31 kHz
Low Voltage Coag	510 kHz bursts of sinusoid at 25% duty cycle recurring at 31 kHz
Bipolar	510 kHz sinusoid, unmodulated

PCH Generator Output Characteristics

	Maximum (open circuit) P-P voltage	Rated Load (ohms)	Nominal Power at rated load (watts)	Crest Factor at rated load (typical)
Cut	3500	300	300	2.1 @ 100W
Blend 1	3800	300	250	3.4 @ 100W
Blend 2	4000	300	200	3.9 @ 100W
Blend 3	4000	300	150	4.7 @ 100W
Coag	7000	300	120	8.5 @ 50W
Low Voltage Coag	4000	300	99	4.7 @ 99W
Bipolar	1200	100	70	2.0 @ 40W

Output Configuration

Isolated output.

Input Power Source

Force 2-2 PCH Generator

Maximum Operating Range	85-135 Vac
Nominal Operating Range	110-120 Vac

The line frequency may vary between 45 and 65 Hz

Current:	Idle - 0.7A, max	Power:	Idle - 60W, max
	Cut - 7.0A, max		Cut - 600W, max
	Coag - 2.9A, max		Coag - 250W, max
	Bipolar - 2.6A, max		Bipolar - 220W, max

Force 2-8 PCH Generator

Maximum Operating Range	170-270 Vac
Nominal Operating Range	220-240 Vac

The line frequency may vary between 45 and 65 Hz

Current:	Idle - 0.4A, max	Power:	Idle - 60W, max
	Cut - 2.9A, max		Cut - 500W, max
	Coag - 1.5A, max		Coag - 250W, max
	Bipolar - 1.3A, max		Bipolar - 220W, max

Line Regulation

Force 2-2 PCH Generator

Between 85 and 135 volts input, output power into nominal load will vary no more than 15% or 5 watts, whichever is greater.

Force 2-8 PCH Generator

Between 170 and 270 volts input, output power into nominal load will vary no more than 15% or 5 watts, whichever is greater.

High Frequency Risk Parameters

Bipolar RF leakage current:	< 59 mA, per IEC 60601-2-2.
Monopolar RF leakage current:	< 150 mA, per IEC 60601-2-2.

Low Frequency Leakage (50-60 Hz)

Force 2-2 PCH Generator

All patient connected terminals tied together:

Source current normal polarity, intact chassis ground	< 10 μ A
Source current normal polarity, ground open	< 25 μ A
Source current reverse polarity, ground open	< 25 μ A
Sink current, 135V applied, all inputs	< 150 μ A
Chassis source current, ground open	< 100 μ A

Force 2-8 PCH Generator

(IEC 60601-1, Section 19 for Class 1 Equipment)

Measured with radio frequency output inactive:

Current Path	Type CF	
	Normal Condition	Single Fault Condition
Earth Leakage Current	0.5 mA	1.0 mA
Enclosure Leakage Current	0.01 mA	0.5 mA
Patient Leakage Current	0.01 mA	0.05 mA
Patient Leakage Current (mains on the applied part)	0.01 mA	0.05 mA
Patient Auxiliary Current	0.01 mA	0.05 mA

REM Contact Quality Monitor

Measurement Frequency	140 kHz \pm 20 kHz
Measurement Current	3.0 mA, maximum
Acceptable Resistance Ranges	Single area pad - nominally < 24 ohms Dual area REM - nominal range 5 - 135 ohms

If impedance measured is outside the acceptance range, a REM alarm will occur. In the REM mode, if resistance increases by more than 40% above the reference value, or above 135 ohms, an alarm will be generated.

Audio Volume

The mode indicator tones are adjustable from 45 to > 65 dBA at 1 meter. The alarm tones are set to a level of > 65 dBA at 1 meter and are not adjustable.

Approximate Weight

10 kg (22 lbs)

Size

20 x 33 x 53 cm (8 x 13 x 21 in.)

Classification

Type CF Equipment per IEC 60601-1

The Force 2 provides a high degree of protection against electrical shock, particularly regarding allowable leakage current and has a CF type isolated (floating) applied part. The applied part may be used on the heart. Defibrillator protected.

Drip Proof per IEC 60601-2-2

The Force 2 enclosure will prevent reasonable amounts of falling liquid from interfering with the generator's safe and satisfactory operation.

All monopolar output measurements are made using the set up referred to in IEC 60601-2-2, Figure 104.

All monopolar output measurements are made using the set up referred to in IEC 60601-2-2, Figure 104.

PCH Generator Typical Output Power vs Load—Monopolar Cut Modes

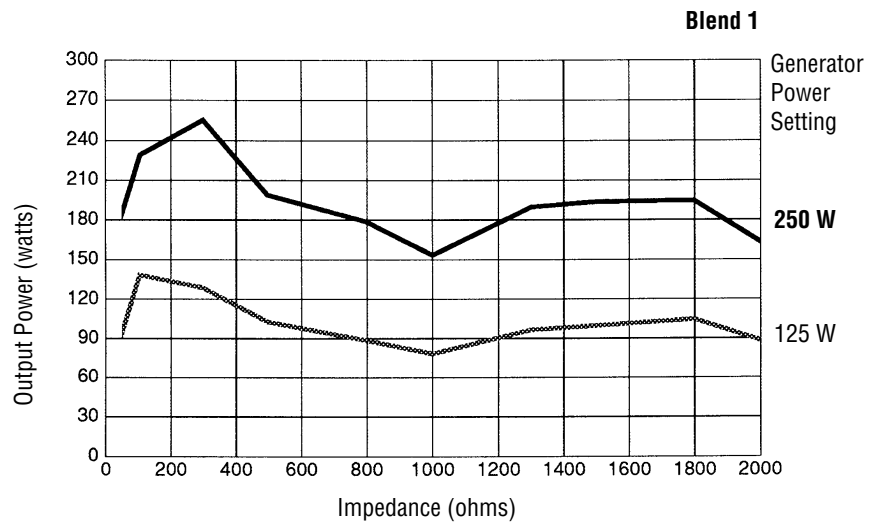
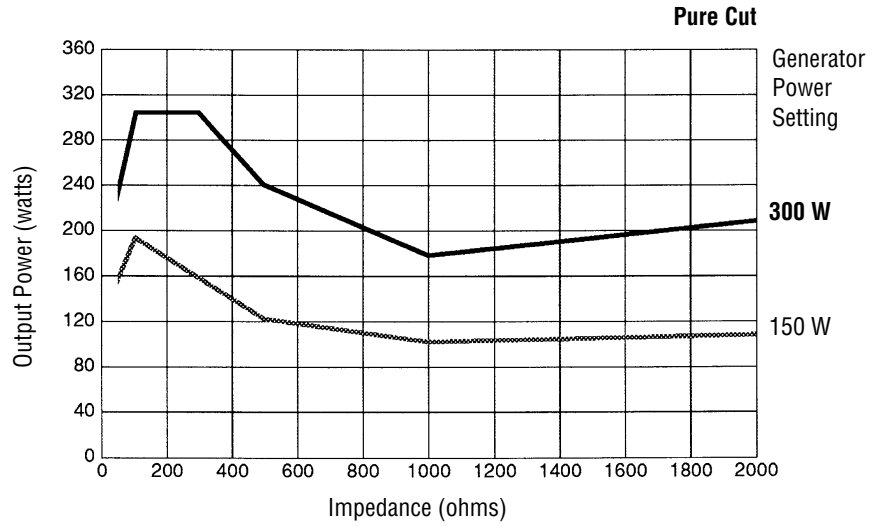

PCH Generator Typical Output Power vs Load—Monopolar Cut Modes
(continued)

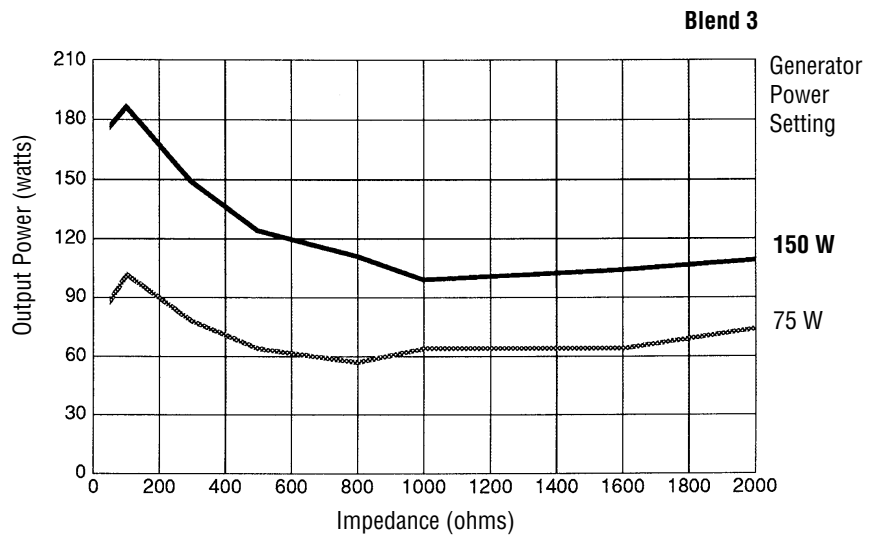
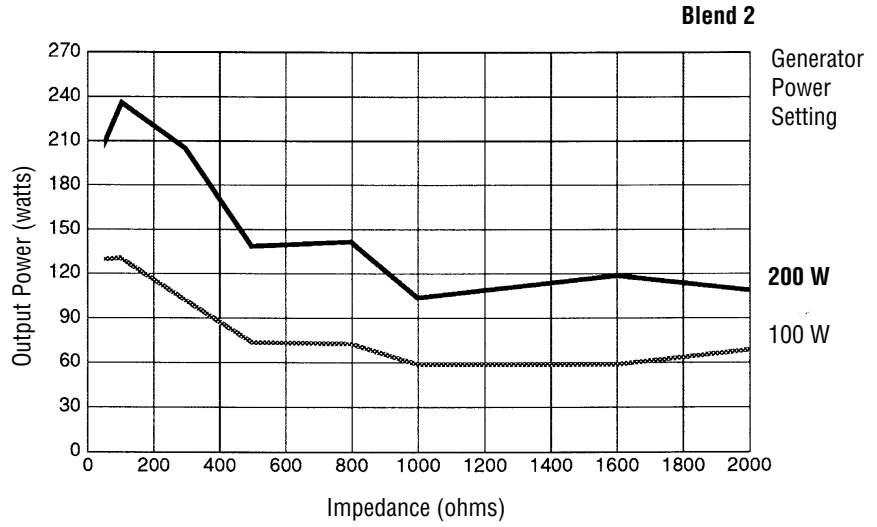

Technical Specifications

**PCH Generator Typical Output
Power vs Load—Monopolar Coag
Modes**

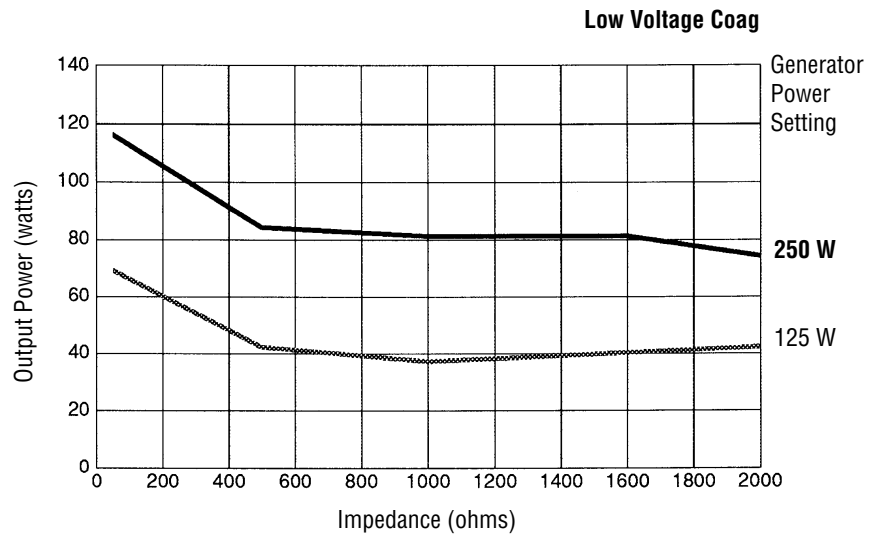
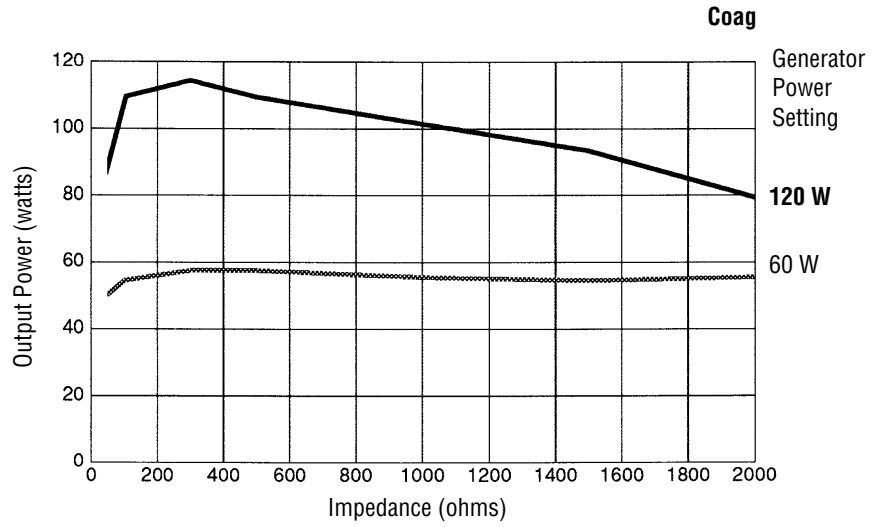

Bipolar measurements are made using bipolar forceps on the insulating surface referred to in IEC 60601-2-2, Figure 104.

PCH Generator Typical Output Power vs Load—Bipolar Mode

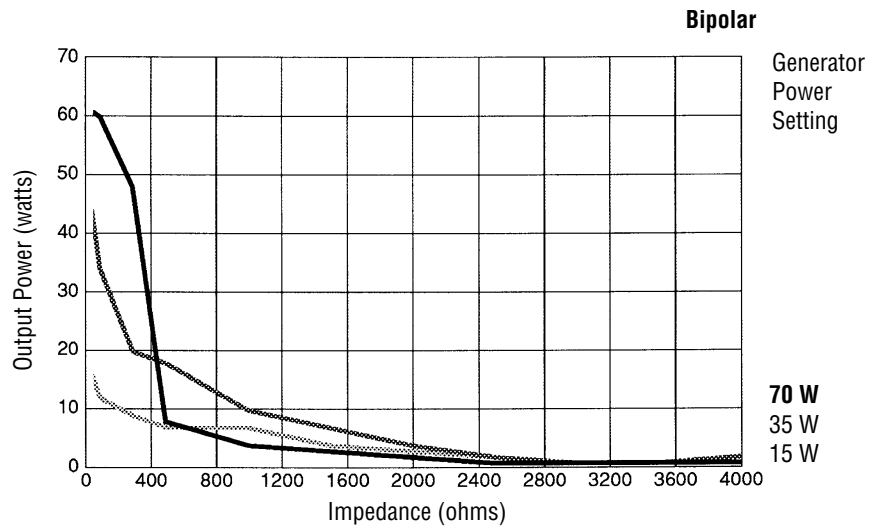

Notes

Warranty

Valleylab, a division of Tyco Healthcare Group LP, warrants each product manufactured by it to be free from defects in material and workmanship under normal use and service for the period(s) set forth below. Valleylab's obligation under this warranty is limited to the repair or replacement, at its sole option, of any product, or part thereof, which has been returned to it or its Distributor within the applicable time period shown below after delivery of the product to the original purchaser, and which examination discloses, to Valleylab's satisfaction, that the product is defective. This warranty does not apply to any product, or part thereof, which has been repaired or altered outside Valleylab's factory in a way so as, in Valleylab's judgment, to affect its stability or reliability, or which has been subjected to misuse, neglect, or accident.

The warranty periods for Valleylab products are as follows:

Electrosurgical Generators	One year from date of shipment
LigaSure™ Generators	One year from date of shipment
LigaSure™ Reusable Instruments	One year from date of shipment
Mounting Fixtures (all models)	One year from date of shipment
Footswitches (all models)	One year from date of shipment
Force Argon™ Units	One year from date of shipment
OptiMumm™ Smoke Evacuator	Two years from date of shipment
CUSA EXcel™ Console	One year from date of shipment
23 kHz Straight and Angled Handpieces, and 36 kHz Straight Handpiece	One year from date of shipment
Sterile Single Use Items	Sterility only as stated on packaging
Patient Return Electrodes	Shelf life only as stated on packaging

This warranty is in lieu of all other warranties, express or implied, including without limitation, the warranties of merchantability and fitness for a particular purpose, and of all other obligations or liabilities on the part of Valleylab. Valleylab neither assumes nor authorizes any other person to assume for it any other liability in connection with the sale or use of any of Valleylab's products.

Notwithstanding any other provision herein or in any other document or communication, Valleylab's liability with respect to this agreement and products sold hereunder shall be limited to the aggregate purchase price for the goods sold by Valleylab to the customer. There are no warranties which extend beyond the terms hereof. Valleylab disclaims any liability hereunder or elsewhere in connection with the sale of this product, for indirect or consequential damages.

This warranty and the rights and obligations hereunder shall be construed under and governed by the laws of the State of Colorado, USA. The sole forum for resolving disputes arising under or relating in any way to this warranty is the District Court of the County of Boulder, State of Colorado, USA.

Valleylab, its dealers, and representatives reserve the right to make changes in equipment built and/or sold by them at any time without incurring any obligation to make the same or similar changes on equipment previously built and/or sold by them.