

# STERRAD<sup>®</sup> NX<sup>™</sup> Sterilization System

---

## User's Guide



 **ADVANCED STERILIZATION PRODUCTS<sup>®</sup>**

a *Johnson & Johnson* company

Division of Ethicon, Inc.

# STERRAD<sup>®</sup> NX<sup>™</sup> Sterilization System

## User's Guide

REF 99920

 **ADVANCED STERILIZATION PRODUCTS<sup>®</sup>**

a *Johnson & Johnson* company

Division of Ethicon, Inc.





















33 Technology Drive, Irvine, CA 92618-9824

Authorized EC Representative  
Ethicon GmbH

Oststraße 1, D-22844 Norderstedt



0 1 2 3

 USA	Irvine, CA 92618	 I	00040 Pomezia, Roma
 F	92787 Issy-les-Moulineaux	 E	28042 Campo de las Naciones, Madrid
 D	22844 Norderstedt	 GB	Ascot, SL5 9EY
 CH	8957 Spreitenbach	 CDN	Johnson & Johnson Medical Products Markham, ON, L3R 0T5
 NL	3800 AD Amersfoort	 J	ジョンソン・エンド・ジョンソン 株式会社 〒101-0065 東京都千代田区西神田 3丁目5番2号
 GR	15125 Maroussi, Athens	 A	1190 Wien
 S	19184 Sollentuna	 BR	Rodovia Presidente Dutra, Km 154 S.J. Campos-S.P 12240-908
 B	1700 Dilbeek	 P	2745-555 Barcarena
 CZ	Na Radosti 399 155 25 Praha 5 - Zličín	 PL	Johnson & Johnson Poland Sp. z o.o. Szyszkowa 20, 20-285 Warszawa
 SK	Jakubovo nám. 13 811 09 Bratislava	 H	Johnson & Johnson Kft. H-2045 Törökbalint, Tó Park

**1-888-STERRAD**

**ASP U.S.A. Customer Care Center 949.581.5799**

**ASP International Customer Support**  
**(Call your local ASP Customer Support Representative)**

**[www.sterrad.com](http://www.sterrad.com)**

© 2005 Advanced Sterilization Products. All rights reserved. Other products mentioned in this publication are trademarked by their respective owners. Reproduction, adaptation, or translation of this publication without prior written permission is prohibited. Printed in the U.S.A.

# Contents

<b>Chapter 1. Introduction</b>	<b>7</b>
How to Use This Guide.....	7
If You Have Questions.....	7
<b>Chapter 2. Safety Information</b>	<b>9</b>
Personal Safety and First Aid .....	9
Personal Protective Equipment .....	10
Device Safety .....	10
Warnings, Cautions, and Notes.....	11
Symbols Used on the Sterilizer and in This Guide .....	11
<b>Chapter 3. Sterilizer Overview</b>	<b>13</b>
Intended Use .....	13
The STERRAD® NX™ Sterilization Process .....	14
Overview of the STERRAD® NX™ Sterilization Cycle.....	15
The STERRAD® NX™ Sterilizer and Features .....	17
Cassette .....	17
Cassette Drawer .....	18
Cassette Disposal Box.....	18
Touch Screen and Speaker .....	18
Chamber .....	19
Printer.....	20
Rear Panel .....	21
Touch Screen Data Entry .....	22
Sterilizer Cart.....	23
<b>Chapter 4. Load Preparation</b>	<b>25</b>
Indications for Use.....	25
Determining What Can be Sterilized in the STERRAD® NX™ Sterilizer .....	26
Recommended Materials and Lumen Chart.....	26
Items Not To Be Processed.....	27
Guidelines for Preparing Items to Be Sterilized.....	28
Cleaning, Rinsing, and Drying.....	28
Packaging and Loading.....	29
Instrument Trays .....	29
Tray Mats .....	29
Packaging.....	30
Loading .....	30
Chemical Indicators .....	31
<b>Chapter 5. Operation</b>	<b>33</b>
Before You Start .....	33
Start and Warm-up.....	33
Inserting a Cassette .....	34
Preparing the Load.....	35
Biological Indicators .....	35
Login.....	35
Entering Load Information .....	37
Enter Load Item Data .....	37
Cycle Notes .....	38

## Contents

---

Loading the Chamber .....	39
Selecting and Starting a Cycle .....	41
Cycle Warm Up.....	42
System Ready Screen .....	42
Cycle in Progress.....	43
Canceling a Cycle.....	43
Cycle Completed.....	44
Processing a Sterilized Load .....	45
Inspecting Chemical Indicators .....	45
Processing Biological Indicators .....	46
<b>Chapter 6. Access Levels and Supervisor Tasks .....</b>	<b>49</b>
Overview .....	49
Access Levels.....	49
Additional Utilities Menu.....	50
Date and Time Settings .....	51
Set Date .....	51
Set Time .....	52
Time Zone .....	52
Date Format.....	52
Time Format.....	52
Cancel/Done .....	52
Dispose Cassette.....	52
Service Functions.....	52
System Configuration.....	53
Access Control Option .....	53
Printout Option .....	53
Vacuum Units.....	54
Load Data Entry Option .....	54
Load Removal Option .....	54
Notepad Option .....	54
Network Option.....	54
Alarm Volume.....	54
Backlight Conservation .....	55
Language Selection .....	55
Cancel/Done .....	55
File Management.....	56
Calibration Files .....	56
Diagnostic Files .....	56
User Administration .....	57
Add User .....	58
Modify User .....	59
Upload User Data .....	60
Steps to Upload a User Database.....	61
Diagnostics.....	62
Diagnostic Tests .....	62
<b>Chapter 7. Reports and Files .....</b>	<b>63</b>
Displayed Reports .....	63
System Summary.....	63
Cycle History.....	67
Printed Reports.....	68
Short Report .....	68
Long Report.....	69

---

Files.....	73
Cycle History Files.....	73
Calibration Files.....	74
Diagnostic Files.....	77
<b>Chapter 8. Maintenance</b> .....	<b>79</b>
Automatic Maintenance.....	79
Pressure Zeroing.....	79
Automatic Lamp Adjustment.....	80
Manual Maintenance.....	81
Disposing of Cassettes.....	81
Removing a Cassette Disposal Box.....	81
Inserting a New Cassette Disposal Box.....	82
Replacing Printer Paper.....	83
Cleaning the Sterilizer Exterior.....	86
Cleaning the Hydrogen Peroxide Monitor Detector Lens.....	86
Replacing the Air Filter.....	87
PCMCIA Card Handling and Replacement.....	88
Sterilizer Disposal.....	90
<b>Chapter 9. Troubleshooting</b> .....	<b>91</b>
System Messages.....	92
Diagnostic Messages.....	94
ASP Customer Care Center.....	101
<b>Appendix A. Warranties and Software License</b> .....	<b>103</b>
Advanced Sterilization Products Commercial Warranty.....	103
Advanced Sterilization Products Service Warranty.....	103
Advanced Sterilization Products Software License.....	104
<b>Appendix B. Consumables, Accessories, and Additional Parts</b> .....	<b>107</b>
<b>Appendix C. STERRAD® NX™ Sterilizer Specifications</b> .....	<b>109</b>



Chapter 1.

# Introduction

## How to Use This Guide

If you are a STERRAD® NX™ Sterilizer operator, **you must read** the “Safety Information” and the “Introduction,” “Load Preparation,” and “Operation” chapters prior to operating the sterilizer. This “Introduction” explains the features and parts of the sterilizer. “Load Preparation” explains how to prepare and package instruments for processing. “Operation” explains how to operate the sterilizer and obtain optimal results.

If you are a supervisor overseeing the STERRAD NX Sterilizer, you should read the entire user’s guide and pay particular attention the chapter featuring “Access Levels and Supervisor Level Tasks.” This chapter describes tasks and options that are only available through “Supervisor Level” access.

The chapters on “Maintenance,” “Troubleshooting,” and the Appendices are designed as references. Keep this user’s guide available so that if a question arises, you can quickly locate the information you need.

## If You Have Questions

If you are located in the United States and have questions about the STERRAD NX Sterilizer or questions about which items may be safely sterilized by the STERRAD Process, please call our Customer Care Center at 1-888-STERRAD (1-888-783-7723). Internationally, call your local ASP Customer Support Representative. You may also wish to visit our website at [www.sterrad.com](http://www.sterrad.com).





## Chapter 2.

# Safety Information

Your safety is of primary concern to Advanced Sterilization Products (ASP). This chapter provides information on safely using the STERRAD<sup>®</sup> NX<sup>™</sup> Sterilizer. **You must read and understand the safety information in this chapter before operating the sterilizer.** Always pay attention to the warnings, cautions and notes throughout this *User's Guide*. This information is for your safety and to ensure that you receive the most benefit from the safe operation of your STERRAD NX Sterilization System.

## Personal Safety and First Aid

**WARNING! HYDROGEN PEROXIDE IS CORROSIVE.**

Concentrated hydrogen peroxide is corrosive to skin, eyes, nose, throat, lungs, and the gastrointestinal tract. Always wear latex, PVC (vinyl), or nitrile gloves while removing items from the sterilizer following a cancelled cycle. Following a cancelled cycle, if items in the load show any visible moisture or liquid, hydrogen peroxide may be present.

**WARNING! HYDROGEN PEROXIDE IS AN OXIDIZER.**

Avoid allowing hydrogen peroxide to contact organic materials, including paper, cotton, wood, or lubricants. Concentrated hydrogen peroxide is a strong oxidizer and may react with organic materials, causing ignition and fire.

**WARNING! RISK OF EYE INJURY.**

Direct hydrogen peroxide contact with eyes can cause irreversible tissue damage. If contact with eyes occurs, immediately flush with large amounts of water. Consult a physician immediately.

**WARNING! RISK OF SKIN INJURY.**

Direct hydrogen peroxide contact with the skin can cause severe irritation. If skin contact occurs, immediately flush with large amounts of water. If symptoms are severe or persist, consult a physician immediately.

## 2 Safety Information

---



**WARNING! RISK OF RESPIRATORY IRRITATION.**

Inhalation of hydrogen peroxide mist can cause severe irritation of lungs, throat, and nose. If inhalation occurs, move to fresh air. Consult a physician immediately.



**WARNING! CONCENTRATED HYDROGEN PEROXIDE IS TOXIC.**

Ingestion of hydrogen peroxide may be life-threatening. If swallowed, drink plenty of water immediately to dilute. Do not induce vomiting. Consult a physician immediately.



**WARNING! STERILIZATION SURFACES.**

At the end of a cycle, the interior of the sterilizer may be hot. Do not touch the inside of the chamber or door with your bare or gloved hands. Allow the sterilizer to cool before touching interior surfaces.



**CAUTION: AVOID EXPOSURE TO ULTRAVIOLET LIGHT.**

The hydrogen peroxide monitor uses an ultraviolet light source located inside the chamber behind the door. To avoid eye injury, do not stare directly at the ultraviolet light source for an extended period of time.

## Personal Protective Equipment



**CAUTION! HYDROGEN PEROXIDE MAY BE PRESENT.**

Wear latex, PVC (vinyl), or nitrile gloves whenever handling a load after a cycle cancellation. Hydrogen peroxide liquid may be present on the load or in the chamber.

## Device Safety



**CAUTION: RISK OF DAMAGE TO LOAD.**

Metal objects must not come into contact with the chamber walls, the door, or the electrode. Contact with the walls, door, or electrode could damage the sterilizer or the metal objects.

## Warnings, Cautions, and Notes



Warnings and cautions are accompanied by symbols surrounded by a triangle and are printed in the text in boldface italics. Warnings indicate events or conditions that can result in serious injury or death. Cautions indicate events or conditions that can result in severe damage to the equipment.

Notes are accompanied a check mark 4and are printed in italics. Notes highlight specific information about the proper use and maintenance of the STERRAD<sup>®</sup> NX Sterilization System.

## Symbols Used on the Sterilizer and in This Guide



Hot surfaces present.  
Do not touch without protection.



Hazardous chemical present.  
Use personal protective equipment.



Toxic chemical present.  
Avoid exposure, contact, or ingestion.



Ultraviolet (UV) light hazard.  
Do not look at the light without UV eye protection.



High voltage hazard.



On/Off.



Alternating current.



Chapter 3.

# Sterilizer Overview

## Intended Use

The STERRAD® NX™ Sterilization System is a general purpose, low temperature sterilizer which uses the STERRAD NX Process to inactivate microorganisms on a broad range of medical devices and surgical instruments. This sterilizer offers an effective, safe, fast, economical, easy to use, reliable, and flexible sterilization method.

When used as directed by the instructions in this user's guide, the STERRAD NX Sterilization System will sterilize both metal and nonmetal medical devices at low temperatures. Please review the "How to Determine What Can Be Sterilized in the STERRAD NX Sterilizer" chart in the "Load Preparation" chapter. This chart contains details on recommended materials and lumen sizes. When selecting reusable medical devices to be processed in the STERRAD NX Sterilizer, reprocessing information should be obtained from the manufacturer of the medical device in accordance with international norms (such as ISO 17664 or AAMI TIR12).

## The STERRAD<sup>®</sup> NX<sup>™</sup> Sterilization Process

As a medical professional, you may already be familiar with general sterilization principles. However, the STERRAD NX Sterilizer represents a new technology, and it requires special attention to the ways in which it differs from other sterilizers.

The STERRAD NX Sterilizer sterilizes medical devices by diffusing hydrogen peroxide vapor into the chamber and then electromagnetically exciting the hydrogen peroxide molecules into a low-temperature plasma state. The combined use of hydrogen peroxide vapor and plasma safely and rapidly sterilizes medical instruments and materials without leaving toxic residues. All stages of the sterilization cycle operate within a dry environment at a low temperature, and thus the cycle is not damaging to compatible instruments sensitive to heat and moisture.

The STERRAD NX Sterilizer can be used for both metal and nonmetal devices, and can also sterilize instruments that have difficult-to-reach (diffusion-restricted) spaces, such as hinges on forceps. Refer to the “Safety Information” chapter for more information.

The sterilizer consistently provides a Sterility Assurance Level (SAL) of  $10^{-6}$ , as defined by U.S. Food and Drug Administration (FDA) and international standards, for clinical use on all allowed substrates within the limits of the claims for materials and geometries when used in accordance with the directions in this user’s guide.

The devices have been pre-validated to an SAL of  $10^{-6}$  based upon worst-case conditions, including lumens within the claim lengths and mated surfaces. If additional technical information concerning validation is needed, please contact your ASP Representative.

---

# Overview of the STERRAD® NX™ Sterilization Cycle

The STERRAD NX Sterilization Cycle consists of two phases: Exposure 1 and Exposure 2. The following information provides a brief description for each of the steps.

## Exposure 1

- ◆ Delivery 1: The hydrogen peroxide is transferred from the cassette into the vaporizer.
- ◆ Vaporization Pumpdown 1: The pressure within the chamber and vaporizer/ condenser is reduced. Water is removed from the hydrogen peroxide solution, leaving behind a concentrated hydrogen peroxide solution in the condenser.
- ◆ Chamber Pumpdown 1: The chamber is isolated from the vaporizer/condenser. The chamber pressure is reduced to remove air from the lumens.
- ◆ Transfer 1: The concentrated hydrogen peroxide solution is transferred to the chamber where it penetrates throughout the load.
- ◆ Diffusion 1: Chamber pressure is increased in order to drive hydrogen peroxide through the load packaging onto the surfaces of the devices and into the lumens of the load.
- ◆ Plasma Pumpdown 1 / Plasma 1: Plasma power is applied to the electrode screen and the plasma is lit.
- ◆ Vent 1: The chamber is vented to atmospheric pressure.

# 3 Sterilizer Overview

---

## Exposure 2

The steps in Exposure 1 are repeated.

### The STERRAD® NX Sterilization Cycle

Phase	Order	Stages
Exposure 1	1	Delivery 1 Vaporization Pumpdown 1 Chamber Pumpdown 1 Transfer 1 Diffusion 1 Plasma Pumpdown 1 / Plasma 1 Vent 1
Exposure 2	2	Delivery 2 Vaporization Pumpdown 2 Chamber Pumpdown 2 Transfer 2 Diffusion 2 Plasma Pumpdown 2 / Plasma 2 Final Vent



# The STERRAD<sup>®</sup> NX<sup>™</sup> Sterilizer and Features

The cassette slot, the cassette drawer, the touch screen, the chamber door, the printer, and the main power switch are found on the front of the sterilizer.

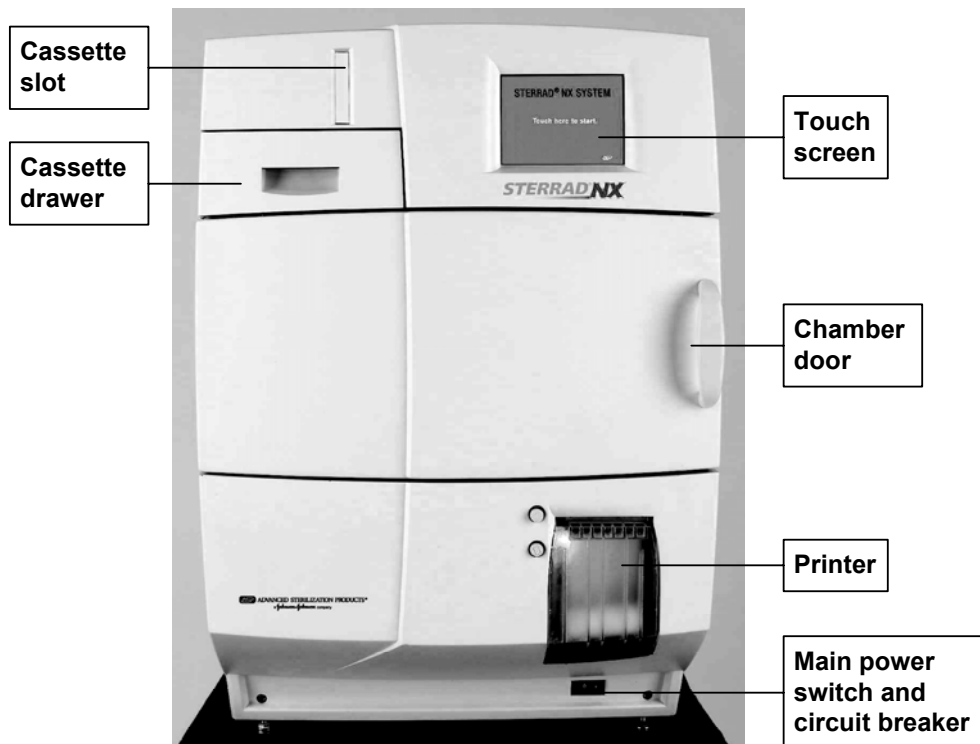

Figure 1. The STERRAD<sup>®</sup> NX<sup>™</sup> Sterilizer.

## Cassette

The cassette contains sealed capsules of precisely measured amounts of hydrogen peroxide solution. Each cassette contains enough sterilant for five cycles. Cassettes are inserted into the sterilizer through the cassette slot. The sterilizer pulls the cassette through the slot and moves it into the machine, keeping it there until the cassette has been processed.

# 3 Sterilizer Overview

---



**Figure 2. Inserting a Cassette.**

## Cassette Drawer

After processing of the cassette, the sterilizer automatically discards it into the cassette disposal box in the cassette drawer.

## Cassette Disposal Box

The cassette drawer contains a cassette disposal box for used cassettes. The box holds three cassettes. When the box is full, the sterilizer displays a message indicating that the drawer must be emptied. The cassette disposal box must be closed to permit safe disposal of cassettes. Refer the “Maintenance” chapter for additional information.

## Touch Screen and Speaker

The sterilizer displays information and accepts commands through a color touch screen. By touching buttons displayed on the screen, you can enter letters and numbers, make selections, and start and stop the sterilizer.

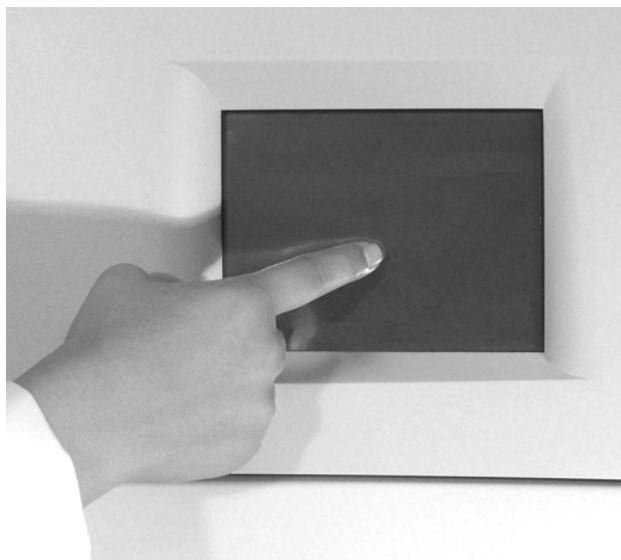

**Figure 3. Using the Touch Screen**

An internal loudspeaker emits “beep” tones to call for user attention or indicate errors. A single long beep indicates a successfully completed cycle. A series of ten short beeps indicates a canceled cycle.

## Chamber

The chamber is where the load is sterilized. The chamber walls and door contain heaters that keep the chamber interior warm during operation. When the chamber door is closed, a vacuum-tight seal is created, allowing the chamber to be evacuated during operation. A locking mechanism prevents the door from being opened when a sterilization cycle is in progress.



**Figure 4. The STERRAD® NX™ Chamber Empty and With the Load Correctly Place.**

The chamber contains two slide-out shelves to permit efficient loading; the top shelf is removable. Inside the chamber, surrounding the shelves, is a metal screen (the electrode) that helps generate plasma during operation.

# 3 Sterilizer Overview

## Printer

The printer prints cycle reports and other information on a roll of thermal paper. The printer features easy drop-in paper loading and requires no ink cartridges. When the sterilizer power is on, the printer interior is illuminated with a blue light.

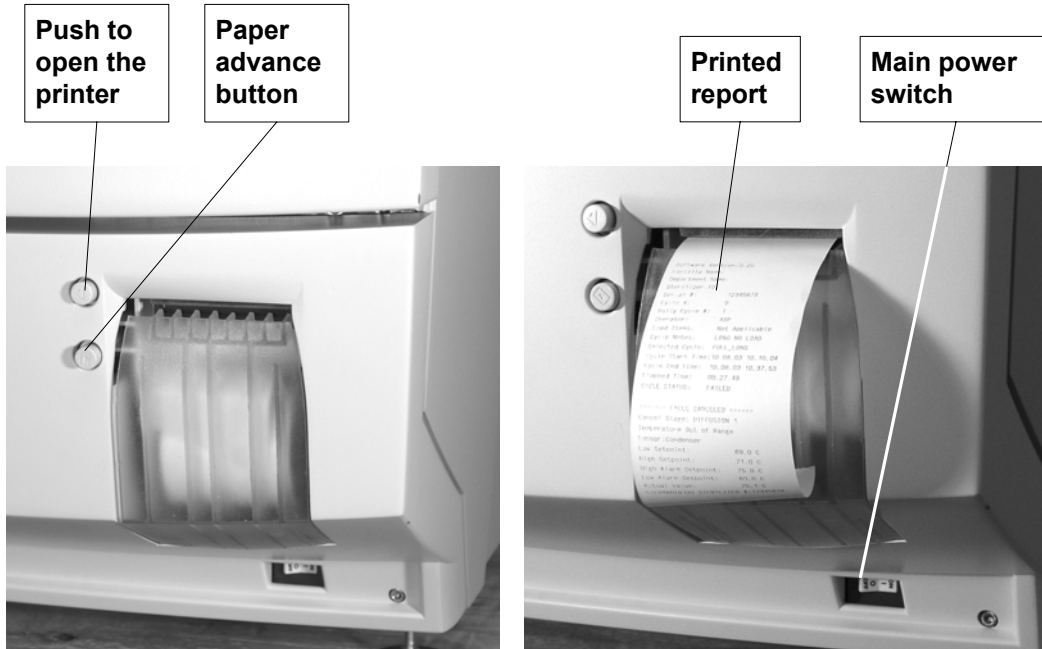

**Figure 5. STERRAD® NX™ Printer, Paper Advance Button and Power Switch Details.**

The top button opens the printer for paper replacement. The bottom button advances the paper when pressed. Note the location of the main power switch under the printer.

## Rear Panel

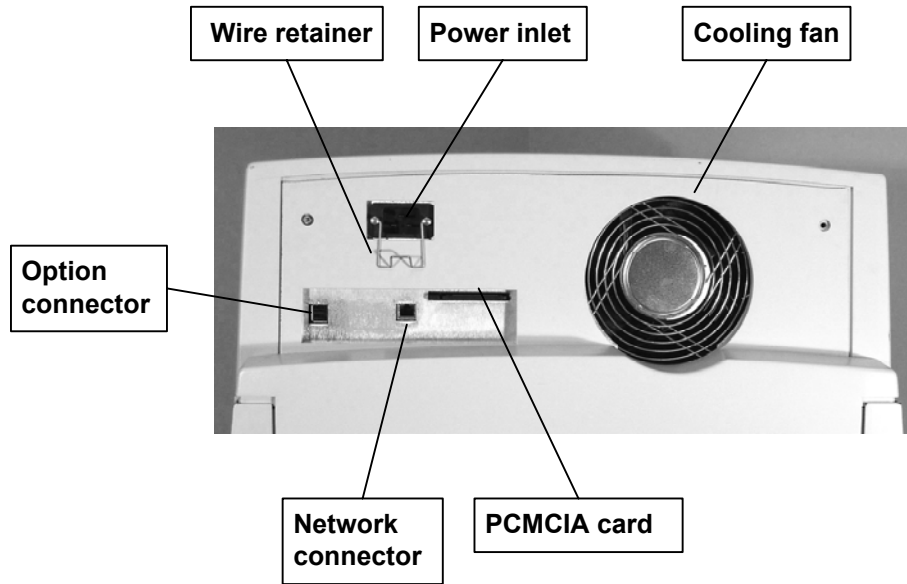

Figure 6. Rear Panel.

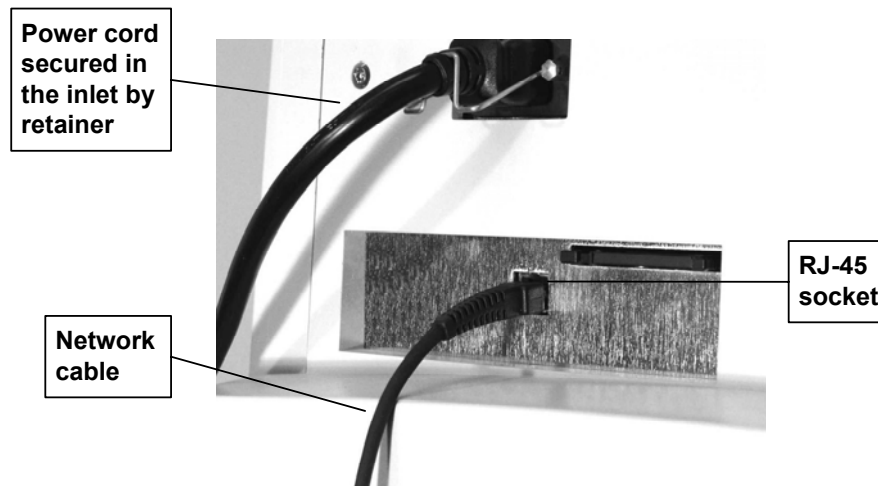

Figure 7. Connection Panel Located on the Lower Rear of the Sterilizer.

## Touch Screen Data Entry

The following figure shows a typical data entry screen. The typewriter “keys” input the indicated character each time a key is touched. You can touch the screen with your finger or with a stylus to move the cursor from place to place.

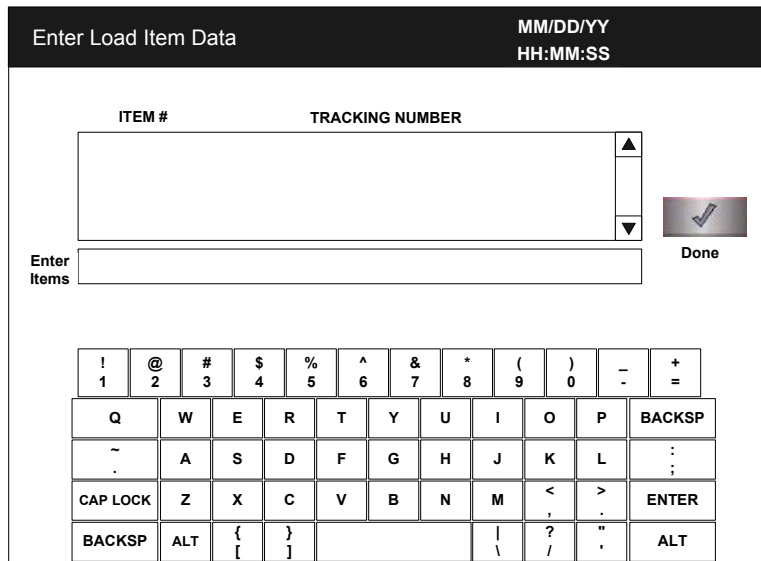







Figure 8. Example of an Information Entry Screen.

Most screens provide function buttons that display other screens or select sterilizer functions. Common function buttons are shown in the following table.

### Function Buttons

Button	Function
	<b>Done.</b> Touch this button to indicate that you are finished using the screen.
	<b>Back.</b> Touch this button to return to a prior screen.
	<b>View.</b> Touch this button to view the selected report or file.
	<b>Print.</b> Touch this button to print the selected report or file.
	<b>Cancel.</b> Touch this button to cancel the entry you just made.

## Sterilizer Cart

The Sterilizer Cart is an optional accessory that may be used to hold the STERRAD® NX™ Sterilizer. The following figure shows the sterilizer placed upon the cart.

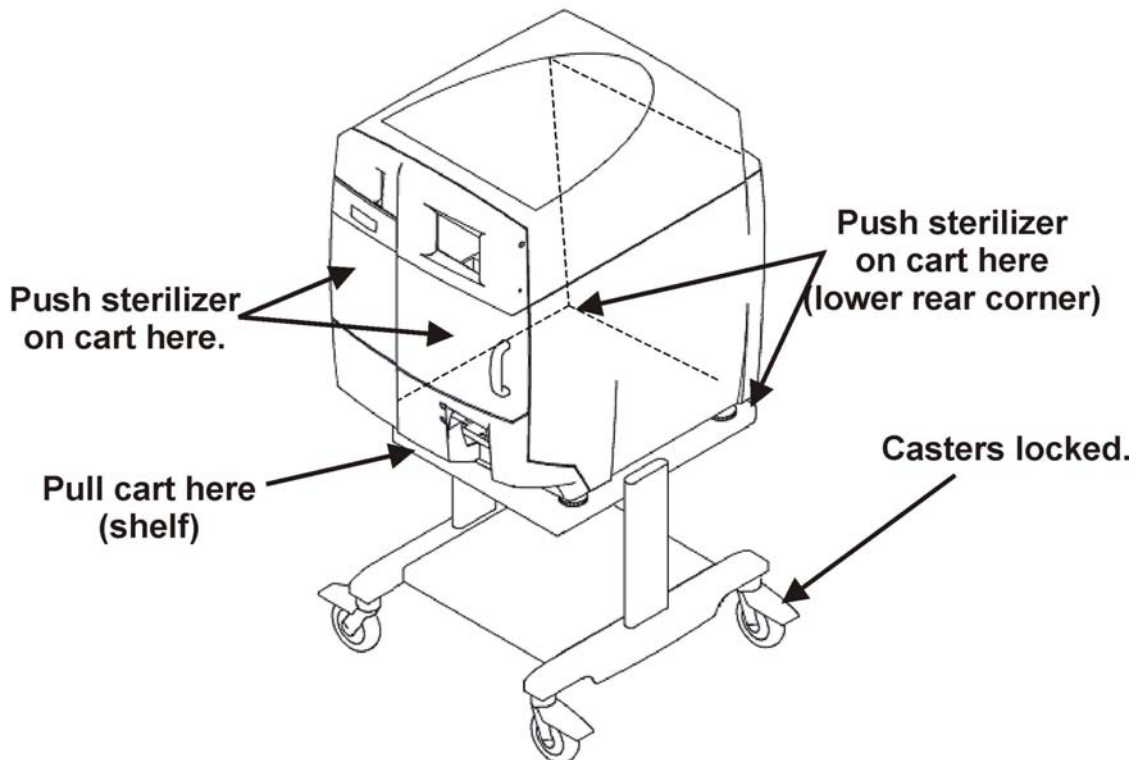

**Figure 9. Sterilizer Cart**

The casters may be locked and unlocked by pressing on caster levers. In order for the cart to have maximum stability, the casters should be oriented in the locked position as shown in the figure above.

The sterilizer may be *pulled* and *pushed* as shown in the figure above. DO NOT push or pull the sterilizer sideways as this is the least stable orientation. DO NOT move the sterilizer with the door open. DO NOT use the door handle to move the sterilizer.

The next chapter describes how to use the STERRAD NX Sterilizer to sterilize your items.





## Chapter 4.

# Load Preparation

## Indications for Use

The STERRAD<sup>®</sup> NX<sup>™</sup> Sterilizer is designed for sterilization of both metal and nonmetal medical devices at low temperatures. The STERRAD sterilization process is a multiphase sterilization process that utilizes a combination of exposure to hydrogen peroxide vapor and plasma to affect sterilization. The STERRAD NX Sterilizer can sterilize instruments which have diffusion-restricted spaces, such as the hinged portion of forceps and scissors.

Medical devices with the following materials and dimensions can be processed in the STERRAD NX Sterilizer **Standard cycle**:

- ◆ Single-channel stainless steel lumens with an inside diameter of 1 mm or larger and a length of 150 mm or shorter.<sup>†</sup>
- ◆ Single-channel stainless steel lumens with an inside diameter of 2 mm or larger and a length of 400 mm or shorter.<sup>†</sup>

Medical devices, including most flexible endoscopes, with the following materials and dimensions can be processed in the STERRAD NX Sterilizer **Advanced cycle**:

- ◆ Single-channel stainless steel lumens with an inside diameter of 1 mm or larger and a length of 500 mm or shorter.<sup>†</sup>
- ◆ Single-channel PE/PTFE flexible endoscopes with an inside diameter of 1 mm or larger and a length of 850 mm or shorter.\*

<sup>†</sup>The validation testing for this lumen size was conducted using a maximum of 10 lumens per load. Hospital loads should not exceed the maximum number of lumens validated by this testing.

\*Only one flexible endoscope per cycle with or without a silicone mat. No additional load.

---

Teflon<sup>®</sup> is a registered trademark of E.I. du Pont de Nemours and Company.

*4 Note: With the exception of the 1 x 850 mm flexible endoscopes, the validation studies were performed using a validation load consisting of one instrument tray weighing 10.7 lbs. The 1 x 850 mm flexible endoscopes were validated without any additional load.*

## Determining What Can be Sterilized in the STERRAD® NX™ Sterilizer



**CAUTION: RISK OF DAMAGE TO LOAD OR STERILIZER.**

Do not attempt to sterilize items or materials that do not comply with the guidelines specified in this user's guide. Consult the medical device manufacturer's instructions or call the ASP Customer Care Center to determine if an item can be sterilized by the STERRAD NX Sterilization System.

## Recommended Materials and Lumen Chart

The following page includes a chart that unfolds to show you detailed lists of recommended items, materials, and some typical devices that can be sterilized in the STERRAD NX Sterilizer. Please refer to it whenever you need materials information. Be sure to check the medical device manufacturer's instructions before loading any item into the STERRAD NX Sterilizer.

There are a wide variety of materials and devices that can be sterilized in the STERRAD NX Sterilizer. As more manufacturers complete testing of their products with the STERRAD NX Sterilizer, the list of compatible items continues to grow. Information in the chart included in this publication is updated as new information becomes available. ASP maintains this updated information and we are happy to share it with you. Please contact the ASP Customer Care Center for an up-to-date list of recommended materials, devices and/or device manufacturer information. Information may also be obtained from the device manufacturer. In the U.S.A., call 1-888-783-7723, internationally call your local ASP Customer Care Representative or contact us through our website – [www.sterrad.com](http://www.sterrad.com).

ASP has validated the processing of non-reusable polyethylene and Teflon<sup>®</sup> (polytetrafluoroethylene) medical grade tubing with the dimension and cycles listed below. These tubing claims have not been reviewed by the Food and Drug Administration (FDA):

- ◆ An inside diameter of 1 mm or larger and a length of 350 mm or shorter can be processed in the STERRAD NX Sterilizer **Standard cycle**.<sup>†</sup>
- ◆ An inside diameter of 1 mm or larger and a length of 1000 mm or shorter can be processed in the STERRAD NX Sterilizer **Advanced cycle**.\*

The FDA has not reviewed these tubing claims as the FDA does not classify tubing as medical devices.

## Items Not To Be Processed

- ◆ Single use items for which the manufacturer does not recommend resterilization.
- ◆ Liquids and powders.
- ◆ Items or materials that absorb liquids.
- ◆ Items made of materials that contain cellulose, such as cotton, paper or cardboard, linens, huck towels, gauze sponges, or any item containing wood pulp.
- ◆ Paper instrument count sheets or lot stickers.
- ◆ Items with mated Nylon<sup>®</sup> surfaces.
- ◆ Instruments and devices that cannot withstand a vacuum and are labeled for gravity steam sterilization methods only.
- ◆ Items whose design permits the surfaces to collapse onto each other unless some method is used to keep the surfaces separated.
- ◆ Dead-end lumens must not be processed.
- ◆ Devices with internal parts, such as sealed bearings, that cannot be immersed may present difficulties in cleaning and should not be processed in the STERRAD NX Sterilizer.

<sup>†</sup>The validation testing for this lumen size was conducted using a maximum of 10 lumens per load. Hospital loads should not exceed the maximum number of lumens validated by this testing.

\*Sterilize without any additional load. Up to 10 pieces of tubing may be sterilized at one time.

---

Nylon<sup>®</sup> is a registered trademark of E.I. du Pont de Nemours and Company.

- ◆ Instrument mats other than STERRAD Instrument Mats.
- ◆ Instrument trays other than STERRAD Instrument Trays or APTIMAX<sup>®</sup> Instrument Trays.
- ◆ Implants for which the manufacturer has not specifically recommended sterilization in the STERRAD<sup>®</sup> NX Sterilizer.

## Guidelines for Preparing Items to Be Sterilized

*4 Note: All items must be cleaned, rinsed, and **thoroughly dried** before being placed in the STERRAD NX Sterilizer. Loads containing moisture may cause cycle cancellations.*

## Cleaning, Rinsing, and Drying

Cleaning and sterilization are two separate processes. As with all sterilization methods, proper cleaning of instruments and devices is a critical and necessary step prior to sterilization. All items must be cleaned, rinsed, and **thoroughly dried** before loading into the sterilizer. Carefully inspect all instruments and devices for cleanliness and dryness and for flaws or damage prior to packaging. If visible soil or moisture is present, the item must be re-cleaned and dried prior to sterilization. Devices and instruments with flaws or damage should be replaced or repaired before using.

The process of cleaning is necessary to remove organic and inorganic soil and debris from equipment. In this process, many microorganisms are removed from the surface of the items. The process of sterilization inactivates all remaining spores and live microorganisms.

- ◆ Remove all blood, tissue, and soil from items by following the device manufacturer's instructions using an appropriate detergent or cleanser.
- ◆ Rinse items thoroughly to remove detergent or cleanser residue.
- ◆ **Dry all items thoroughly.** An acceptable method for drying is to blow compressed gas through the lumen until no moisture exits the distal end of the device. Please ensure that any method used to dry the devices is in accordance with the manufacturer's instructions for use or contact the device manufacturer to obtain appropriate and safe procedures. It is necessary to remove moisture from all parts of the items. **Only dry items should be loaded into the sterilization chamber to prevent cycle cancellation.**

- ◆ Some complex reusable medical devices may require disassembly for proper cleaning and sterilization. It is very important that you follow the device manufacturers recommendations concerning cleaning and sterilization.

**WARNING! POSSIBLE NON-STERILE DEVICE**

*Loads containing moisture may result in either a non-sterile device or cycle cancellation.*

*4 Note: Periodic careful inspection of items after repeated exposure to disinfectant/cleaner/ sterilant is necessary, due to the potential damaging effects of the chemical agent on the items.*

## Packaging and Loading

If you choose to package the instruments, proper preparation of trays, pouches, and instruments can minimize or prevent cycle cancellations and positive biological indicator (BI) results due to load-related problems. All instruments must be cleaned, rinsed, and **thoroughly dried** before loading into the sterilizer.

### Instrument Trays

- ◆ Only STERRAD Instrument Trays, APTIMAX<sup>®</sup> Instrument Trays, and STERRAD accessories are recommended for use in the STERRAD NX Sterilizer. These instrument trays are specially designed to allow diffusion of hydrogen peroxide and plasma around every item in the load.

### Tray Mats

- ◆ Instrument trays should only be padded with STERRAD Instrument Mats or polypropylene sterilization wrap. **Never use** linen, cellulose, or any materials in the “Items Not To Be Processed” section.
- ◆ Follow the *Instructions for Use* included with the STERRAD Instrument Mats to determine the number of mats that can be used at one time in the chamber. Do not use more than 174 square inches (1123 sq. cm) of mat material in the chamber at any time.
- ◆ Do not use foam pads in instrument trays. They may absorb the hydrogen peroxide.

# 4 Load Preparation

---

## Packaging

- ◆ Use only STERRAD Sterilizer-compatible polypropylene sterilization wrap and Tyvek<sup>®</sup> pouches.
- ◆ Do not use paper pouches or sterilization wraps containing cellulose or cotton.
- ◆ Do not use any wraps or packaging that are not approved by ASP or materials on the “Items Not To Be Processed” section.
- ◆ Arrange the items in a tray to ensure proper diffusion of hydrogen peroxide throughout the load.
- ◆ Place peel pouches on edge, if possible. Arrange them so that the transparent side of a pouch faces the opaque side of the next pouch. Do not stack pouches on top of each other.
- ◆ Do not stack instruments inside the trays. Do not stack trays. Do not stack trays within trays. Do not wrap instruments within a wrapped tray.
- ◆ If you are using rigid containers cleared by the FDA for use in the STERRAD NX Sterilizer, follow the same procedures that are recommended for use with the STERRAD Instrument Trays or APTIMAX<sup>®</sup> Instrument Trays. Do not stack instruments inside the containers. Do not stack containers. Do not stack containers within containers. Do not wrap instruments within the containers.
- ◆ Place STERRAD Chemical Indicator Strips inside trays and pouches as needed.

## Loading

- ◆ Do not allow any item to touch the walls of the sterilization chamber, door, or electrode.



**CAUTION: RISK OF DAMAGE TO LOAD OR STERILIZER.**

Assure that metal objects do not come into contact with the walls of the chamber, door, or electrode. Contact with the walls, door, or electrode can cause a cycle cancellation, and/or damage the item or the sterilizer. Provide at least 1 inch (25 mm) of space between the top of the load and the electrode.

---

Tyvek<sup>®</sup> is a registered trademark of E.I. du Pont de Nemours and Company.

## Chemical Indicators

STERRAD<sup>®</sup> Chemical Indicator Strips and STERRAD<sup>®</sup> SealSure<sup>®</sup> Chemical Indicator Tape offer a method to verify that the load has been exposed to hydrogen peroxide in the sterilizer. Chemical indicators are not a substitute for biological indicators.

If you use chemical indicator strips or chemical indicator tape, follow the *Instructions for Use* that accompany these items as you prepare the load.

- ◆ Place STERRAD<sup>®</sup> Chemical Indicator Strips inside trays and Tyvek<sup>®</sup> pouches.
- ◆ Secure all wraps with STERRAD<sup>®</sup> SealSure<sup>®</sup> Chemical Indicator Tape.
- ◆ Do not use chemical indicators designed for other sterilization processes.

---

Tyvek<sup>®</sup> is a registered trademark of E.I. du Pont de Nemours and Company.





Chapter 5.

# Operation

## Before You Start

Each time you use the STERRAD® NX™ Sterilizer, follow the instructions provided in the chapter on load preparation. It is the operator's responsibility to be familiar with the information provided in this user's guide.

## Start and Warm-up

1. Turn on the main power switch—it is located at the front of the sterilizer, below the printer.
2. Close the door. The sterilizer begins by warming up. The warm-up can take up to 30 minutes.
3. “Touch Screen to Start” appears on the display.



**Figure 10. Touch the Screen to Start Your Cycle**

The screen displays the message “Please Insert New Cassette” if a new cassette is required, if the cassette in the sterilizer is expired, or if there is no cassette installed in the sterilizer. Follow the instructions in the next section to insert a new cassette.

If the sterilizer is loaded with an unexpired cassette, skip to the subsection titled “Preparing the Load.”

## Inserting a Cassette

1. Take a new STERRAD NX Cassette out of the shipping carton.
2. Look at the package carefully before opening it. The indicator strip should be a yellow color. **If the indicator strip is red, do not open the package**—it is possible that hydrogen peroxide has leaked inside the package. Refer to the cassette *Instructions for Use* for proper handling instructions.
3. If the indicator strip is yellow, open the cassette package.
4. Insert the cassette into the cassette slot until it stops moving as shown in the following figure. **Do not use force** to push the cassette into the machine.



**Figure 11. Inserting the Cassette into the Slot.**

5. After a slight pause, the sterilizer pulls the cassette through the slot and the slot door closes. Cassette loading is now complete.

## Preparing the Load

While the sterilizer is warming up, you can use this time to prepare the load. Refer to the chapter detailing load preparation information.

### Biological Indicators

Confirming that sterilizing conditions were achieved during a cycle is an important part of the sterilization process. Biological indicators are one way to ensure that your sterilizer is operating correctly. ASP recommends using the STERRAD® CycleSure® Biological Indicator. Contact your ASP Representative regarding biological indicators specifically designed for use in the STERRAD NX Sterilizer.

Place a STERRAD® CycleSure® Biological Indicator in the chamber at the back of the bottom shelf. Biological testing should be performed at least once per day or as specified by your facility's policy. Review the instructions for use included with the biological indicator to ensure its proper use.

## Login

**4 Note:** *If your sterilizer has been configured not to require operator login, the login screen will not appear. Skip to the subsection titled *Entering Load Information*.*

When you touch the “Touch Screen to Start” screen, the sterilizer displays the Operator Login screen.

# 5 Operation

Operator Login
MM/DD/YY  
HH:MM:SS

Operator:

Password:

!	@	#	\$	%	^	&	*	(	)	-	=	
1	2	3	4	5	6	7	8	9	0	-	=	
Q	W	E	R	T	Y	U	I	O	P	BACKSP		
~	A	S	D	F	G	H	J	K	L	:	;	
.	A	S	D	F	G	H	J	K	L	:	;	
CAP LOCK	Z	X	C	V	B	N	M	<	>	ENTER		
								,	.			
BACKSP	ALT	{	}						?	"	ALT	
		[	]					\	/	'		

**Legend**

**MM:** month  
**DD:** day  
**YY:** year

**HH:** hour  
**MM:** minute  
**SS:** second

Figure 12. Operator Login Screen.

1. Touch the **Operator** field. The cursor appears in the field.
 

*4 Note: Operator and Password fields are case-sensitive.*
2. Use the on-screen keyboard to type your assigned operator identification.
3. Touch the **Enter** key. The cursor jumps to the **Password** field.
4. Type your password. The screen displays a series of “\*” characters in place of the characters you type. This is done to keep others from reading your password.
5. When you have finished entering your password, touch the **Enter** key.

# Entering Load Information

**4 Note:** *If your sterilizer has been configured not to require load item data, this screen will not appear. Skip to the subsection titled Cycle Notes.*

## Enter Load Item Data

The Load Item Data screen allows you to enter information about the contents of the load. This can be done for tracking and traceability or may be useful for inventory purposes.

The Load Item Data screen allows you to enter a list of items in your load and their associated tracking numbers (if any). This information is stored by the sterilizer and is printed on a cycle report (and can be transferred to a host computer over the network connection).

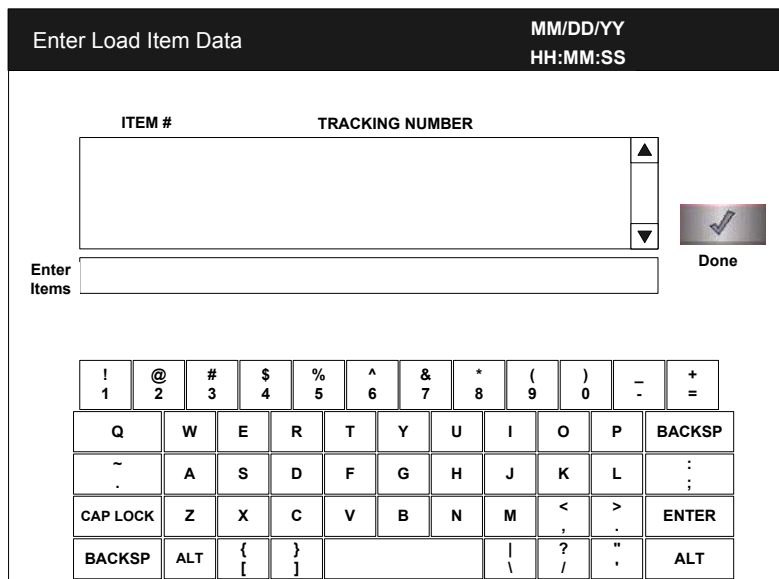

**Figure 13. Enter Load Item Data**

1. Touch the **Enter Items** field. The cursor appears in the field.
2. Use the on-screen keyboard to type a description of each item or its tracking number.
3. When you have entered an item, touch the **Enter** key. The line you typed moves to the list box.
4. Continue entering information, one line at a time, until you are finished.
5. When data entry is complete, touch the **Done** button.

# 5 Operation

6. The program displays the Enter Cycle Notes screen.

A barcode scanner can also be used to enter load item data. Refer to the barcode scanner *Instructions for Use* if your sterilizer is equipped with this option.

## Cycle Notes

**4 Note:** *If your sterilizer has been configured not to require cycle notes, this screen will not appear. Skip to the subsection titled “Loading the Chamber.”*

The Cycle Notes screen allows you to enter information about the cycle. This screen can be used to record information about biological indicators used in the cycle or any other information that should be stored in the cycle history file. This information is printed out on the cycle report (and can be transferred to a host computer over the network connection).

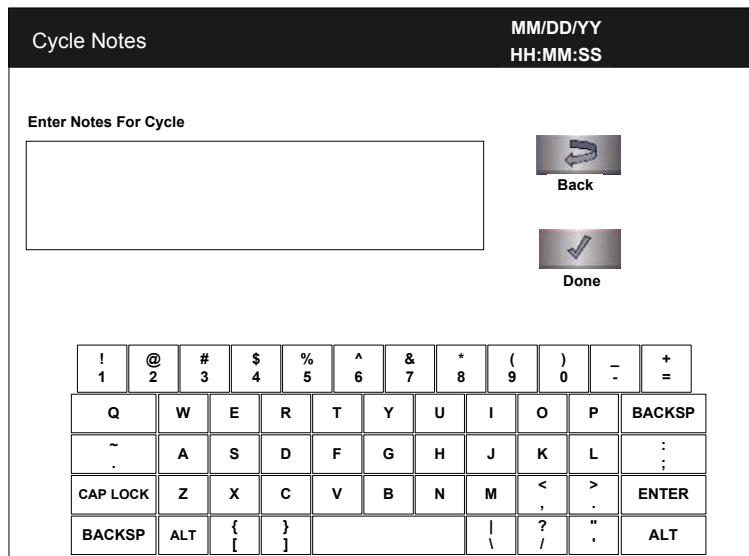

Figure 14. Cycle Notes.

1. Touch the **Enter Notes for Cycle** field. The cursor appears in the field.
2. Use the on-screen keyboard to type your notes.
3. When data entry is complete, touch the **Done** button.
4. If conditions exist which prevent a sterilization cycle from starting (e.g., no cassette, hydrogen peroxide monitor blocked), a message is displayed on the screen.
5. The program displays the System Ready screen.

## Loading the Chamber

1. Open the chamber door and place your load on the shelves.



**Figure 15. Open the Door and Place your Load on the Shelf.**

**4 Note:** *If necessary, the top shelf can be removed to accommodate a large load placed on the bottom shelf.*

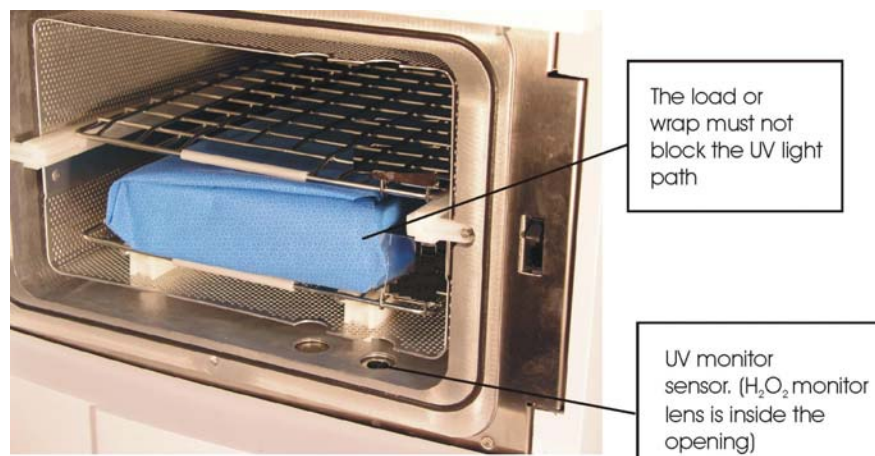

**Figure 16. Do Not Block the UV Lamp.**

# 5 *Operation*

---

2. When placing the load on the shelves, make certain that you do not block the beam of the ultraviolet lamp in the front right corner of the chamber.



**Figure 17. The Load Should NOT Touch the Electrode.**

3. Do not allow any part of the load to touch the electrode, the back wall of the chamber, or the inside of the door.
4. Leave at least 1 inch (25 mm) of free space between the load and the electrode to allow hydrogen peroxide to diffuse around the load.



**Figure 18. Close the Door.**

5. When finished loading the chamber, close the door tightly.
6. If the message “Please Close Door” is displayed, the door is not securely closed. Make certain that nothing is caught in the door seal.



## Selecting and Starting a Cycle

When the load has been placed in the chamber, and the door has been tightly closed, use the System Ready screen to select the sterilization cycle appropriate for the load.

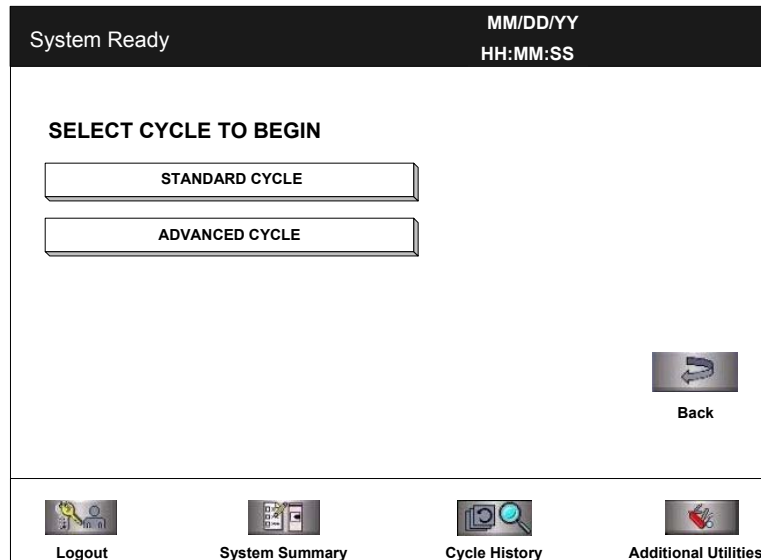

**Figure 19. System Ready.**

1. Touch the button that corresponds to the cycle that is appropriate for the load you wish to sterilize.
2. The sterilizer loads the cycle program and displays the **Start Cycle** button.
3. If an incorrect cycle has been selected, touch the **Cancel** button and then select the correct cycle.
4. Touch the **Start Cycle** button to start the selected cycle.

## Cycle Warm Up

When changing from one type of cycle to another; i.e., from Standard to Advanced or from Advanced to Standard, the sterilizer requires time to warm up.

1. The sterilizer displays the System Warming Up message.



**Figure 20. System Warming Up,**

2. The message provides a cancel button to allow the user to cancel the cycle.
3. If the sterilizer temperature does not reach the setpoints within 10 minutes, the sterilizer returns to the System Ready screen and the display directs you to the proper action.
4. Once the temperatures are within the correct range, the sterilizer begins a “count down clock” as described in the “Cycle In Progress” section.

## System Ready Screen

The System Ready screen displays a row of buttons along the bottom of the screen. These buttons select sterilizer functions:

- ◆ **Logout** is used when the current operator is finished using the sterilizer. When Logout is selected, you must login to use the sterilizer.
- ◆ **System Summary** displays the System Summary file and allows you to print a copy.
- ◆ **Cycle History** displays the Select Cycle History screen. This screen allows you to select a cycle history file and view or print it.
- ◆ **Additional Utilities** is available only to operators with Supervisor-level access. It displays the Additional Utilities Menu.

## Cycle in Progress

When you touch the **Start Cycle** button, the sterilizer starts a “countdown clock” and begins the sterilization cycle.

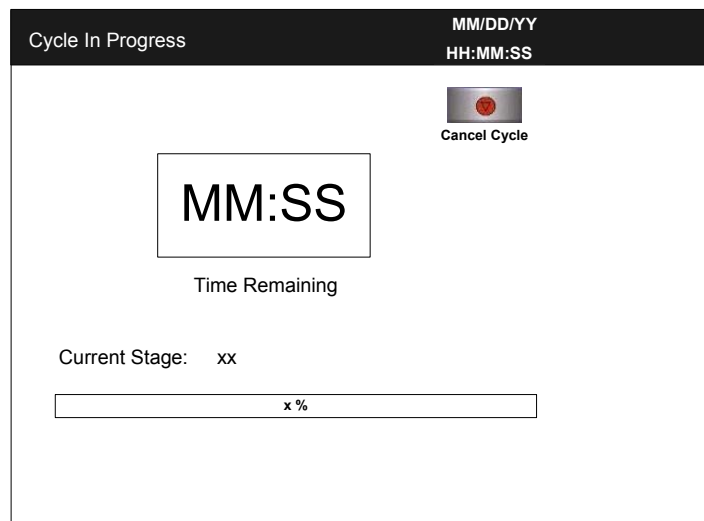

**Figure 21. Cycle In Progress. The Countdown Clock is Displayed.**

The clock displays the estimated number of minutes and seconds remaining before the cycle is finished. The “Time Remaining” field updates as the sterilization cycle progresses. As each sterilization cycle stage runs, the screen displays the name of the stage. A moving bar graph also displays the percent of the cycle that is complete. For details about the current stage information, refer to the Long Report printout in the “Reports and Files” chapter.

## Canceling a Cycle

There may be occasions when it is necessary to cancel a cycle before it is completed.

To cancel a cycle, do the following:

1. Touch the Cancel Cycle button. The screen displays a confirmation message.

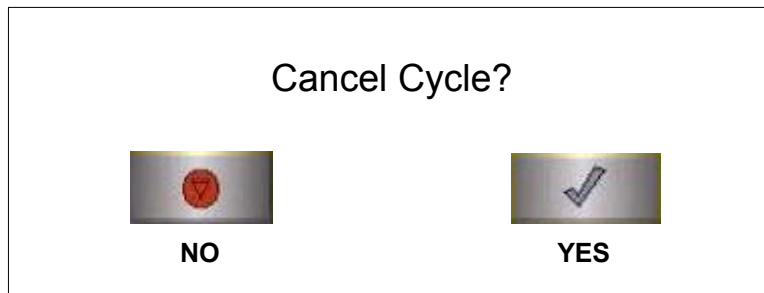

**Figure 22. Cancel Cycle Confirmation. Touch Yes or No.**

2. Touch the **No** button to proceed with the cycle. Touch the **Yes** button to cancel the cycle. Once the cycle cancellation sequence begins, the screen turns red and the cancellation sequence cannot be interrupted. The cancellation sequence may take up to ten minutes to complete.

Loads from canceled cycles should be rewrapped using new packaging materials, STERRAD<sup>®</sup> Chemical Indicator Strips, and STERRAD<sup>®</sup> SealSure<sup>®</sup> Chemical Indicator Tape. If a biological indicator was used in the canceled load, the previously used biological indicator must be discarded and a new biological indicator must be placed in the chamber before restarting the new cycle.



**WARNING! HYDROGEN PEROXIDE MAY BE PRESENT.**

*If a cycle cancels and the items in the load appear wet, hydrogen peroxide may be present. Wear latex, PVC (vinyl), or nitrile gloves while removing the items from the chamber, and while wiping off the items with a damp cloth.*

## Cycle Completed

When the cycle is complete, the Cycle Completed screen is displayed. The background of the screen is green to indicate a successfully completed cycle. The loudspeaker emits one long beep to indicate successful cycle completion.



**Figure 23. Cycle Completed.**

1. Touch the **View Details** button to display the cycle history file for the just-completed cycle.
2. Touch the **Done** button to proceed.

## Processing a Sterilized Load

When you touch the **Done** button, how the sterilizer responds depends upon the configuration of your sterilizer.

- ◆ If login is required before the door can be opened, the Login screen is displayed. When this occurs, enter your operator identification and password and touch the **Done** button. The door unlocks and the load can be removed.
- ◆ If no login is required for load removal, the door unlocks and the load can be removed.
- ◆ Refer to the cycle completion flowchart on the next page for additional information.

## Inspecting Chemical Indicators

After ensuring that the chemical indicators exhibit the correct color change, and the cycle printout shows that all parameters were met, the sterilized load is ready for immediate use, following your facility's policy. If the chemical indicators do not exhibit the correct color change, investigate the cause and repackage and reprocess the load.

## Processing Biological Indicators

Remove the biological indicator from the load and process it per its *Instructions for Use*. Refer to the biological indicator flow chart on the next page for additional information.

### Cycle Completion Flowchart

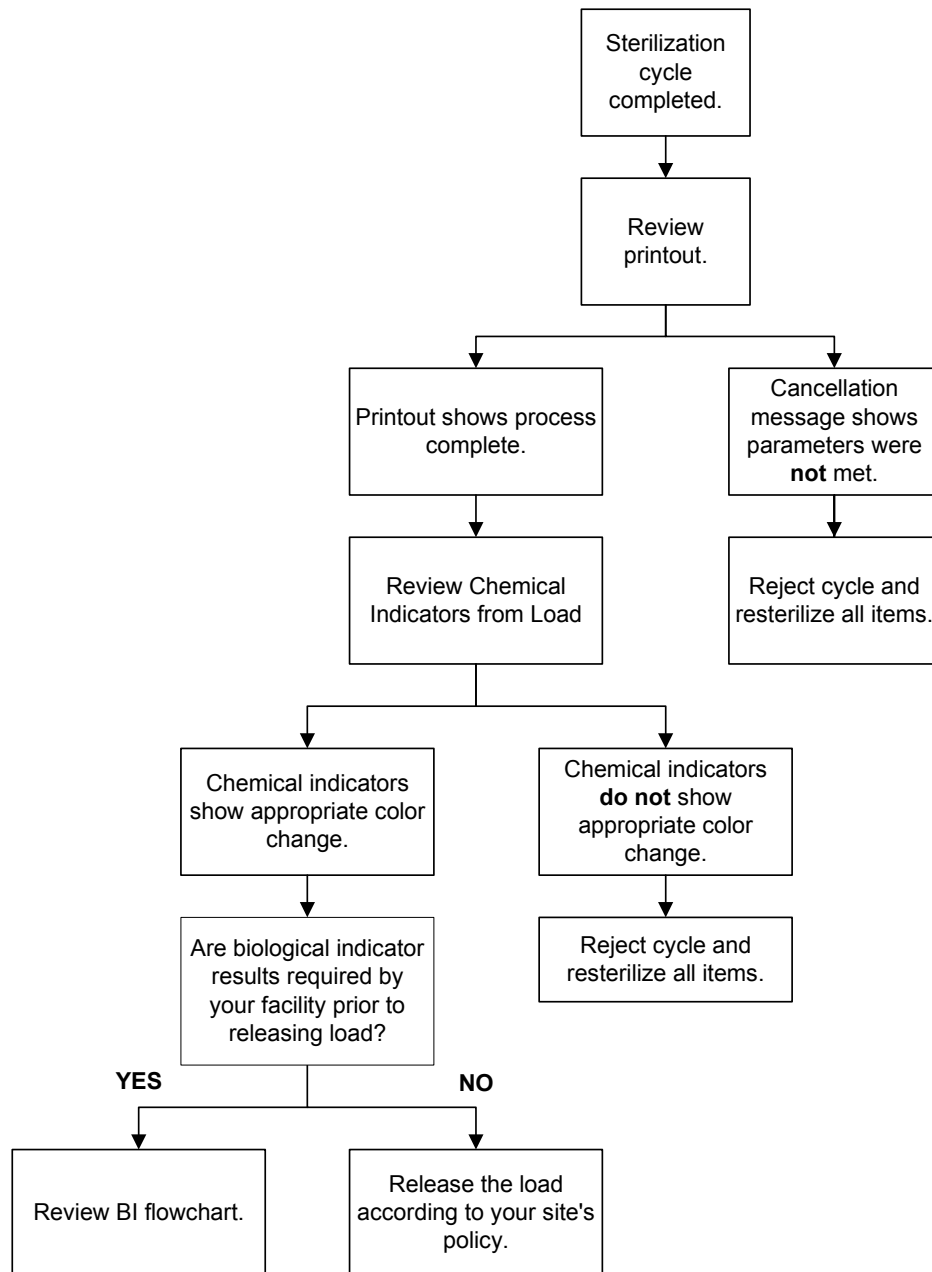

**STERRAD® CycleSure® Flowchart**

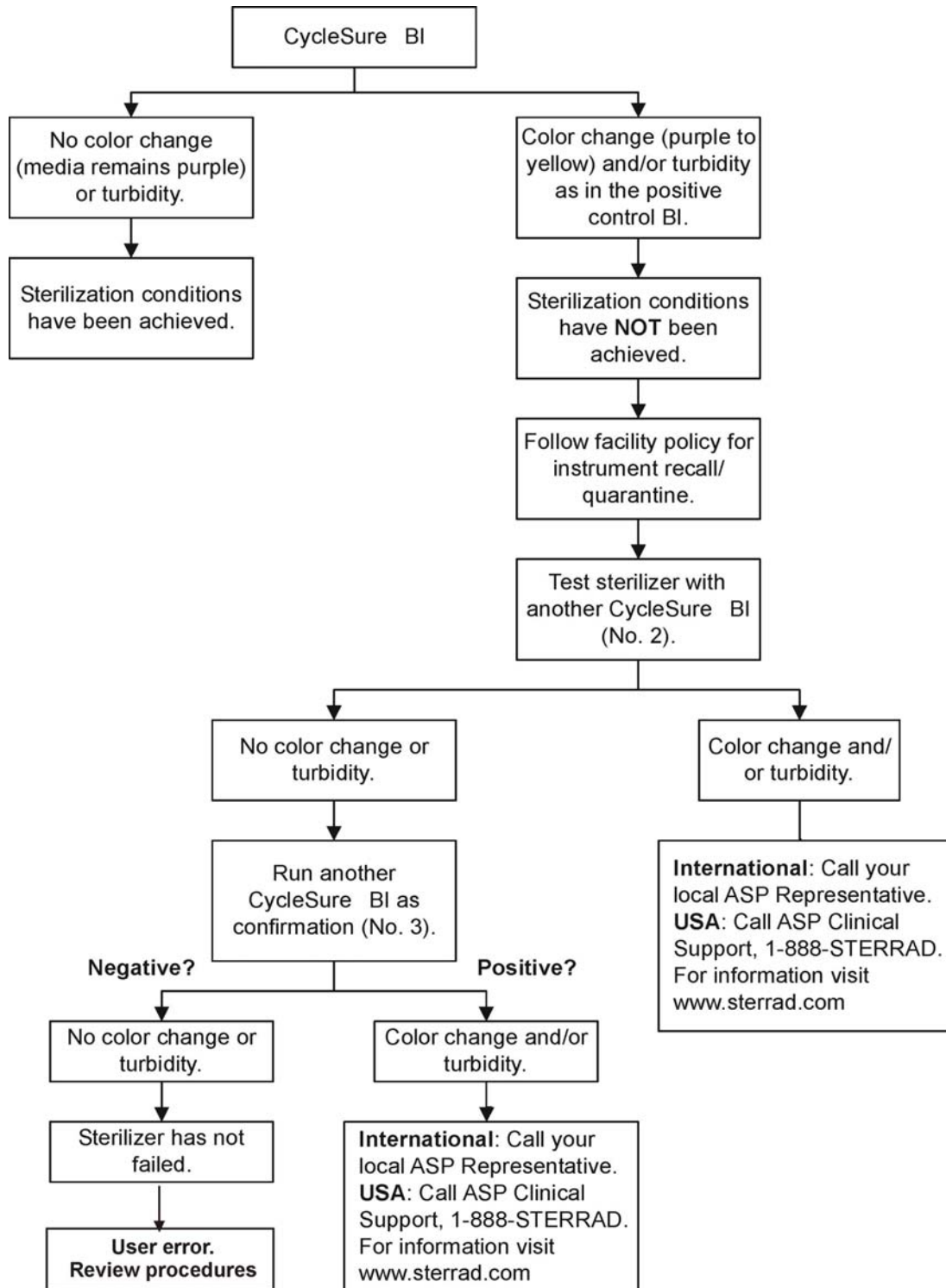





Chapter 6.

# Access Levels and Supervisor Tasks

## Overview

Users with supervisor-level access privileges (see below) are permitted to perform a set of restricted sterilizer functions. These functions are not used in daily sterilizer operation and some of them are designed to control access, manage system records, and perform advanced diagnostic functions.

## Access Levels

The STERRAD® NX™ Sterilizer can be configured to require that all users enter a valid operator identification and password before operating the sterilizer. This access control is enabled through the System Configuration screen and user identifications, passwords, and access levels are assigned and maintained through the User Administration screens.

There are three levels of access available. Each is associated with a different subset of permitted operations.

**Operator-level access** is designed to permit a user to perform tasks associated with the daily operation of the sterilizer. These privileges allow a user to:

- ◆ Select, start, and cancel a cycle
- ◆ Enter load item information and cycle notes
- ◆ Print a cycle history report and view cycle history files

**Supervisor-level access** includes all of the privileges of Operator-level access and additionally provides the ability to:

- ◆ Add, delete, and modify user names, passwords, and access levels

# 6 Access Levels and Supervisor Tasks

- ◆ Select, view, and print all sterilizer files
- ◆ Run diagnostic tests and print reports
- ◆ Set date and time
- ◆ Configure sterilizer options
- ◆ Configure the network connection and upload data to the network

**Service-level access** is only for use by ASP Service Representatives.

## Additional Utilities Menu

The Additional Utilities Menu is available only to users with Supervisor- or Service-level access privileges. If a user with Operator-level privileges touches an **Additional Utilities** button on any screen, the Login screen will be displayed with the message: “Supervisor- or Service-Level Login Required.”

The Additional Utilities Menu allows supervisors to configure the sterilizer and the network connection, set the date and time, set up and maintain user privileges, view and print files, perform diagnostic tests, and dispose of cassettes.

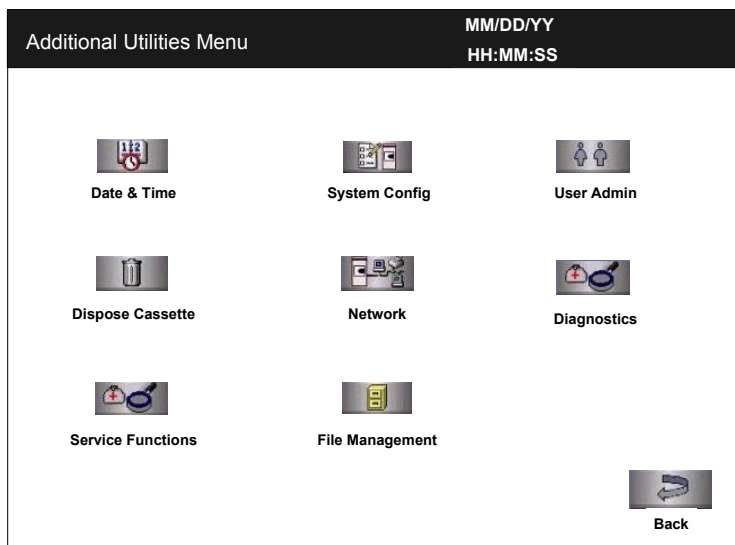

Figure 24. Additional Utilities Menu.

Figure 65. Additional Utilities Menu

**Date & Time** allows you to set the date, time, time zone, and formats used for displaying and printing date and time.

**Dispose Cassette** moves the currently loaded cassette into the cassette disposal drawer.

**Service Functions** are reserved for use by ASP Service Representatives.

**System Config** allows you to set sterilizer options.

**Network** allows you to configure the network connection.

**File Management** allows you to select, display, and print files.

**User Admin** allows you to add, delete, or modify operator identifications, passwords, and access levels.

**Diagnostics** starts a sequence of operator-assisted diagnostic tests and prints a diagnostic test report.

The **Back** button returns you to the screen from which you selected “Additional Utilities.”

## Date and Time Settings

Use the Date and Time Settings screen to set the date and time, and select the local time zone and display formats.

Figure 25. Date and Time Setting

### Set Date

Use the MM box to set the month (01-12), the DD box to set the day (01-31), and the YY box to set the year.

# 6 *Access Levels and Supervisor Tasks*

---

## Set Time

Use the HH box to set the hour (01-12 if 12-hour format is selected, 00-23 if 24-hour format is selected). Use the MM box to set the minute (00-59) and the SS box to set the second (00-59). If 12-hour format is selected, you may only select hours 01-12, and you must touch the **AM** or **PM** buttons to indicate the correct time.

## Time Zone

Scroll through the selections until your time zone is displayed.

## Date Format

Select the desired format for the date. The formats that include “YYYY” display a four-digit year.

## Time Format

Select 12-hour or 24-hour format. If 12-hour format is selected, the **AM** and **PM** buttons on the **Set Time** line are enabled. If 24-hour format is selected, the **AM** and **PM** buttons are disabled.

## Cancel/Done

To cancel the date or time setting, touch the **Cancel** button. When the date and time settings are correct, touch the **Done** button to return to the Additional Utilities menu.

## Dispose Cassette

Touch the **Dispose Cassette** button when you want to dispose of a cassette that is currently loaded in the sterilizer. The Dispose Cassette function moves the cassette from inside the sterilizer to the cassette drawer. Once a cassette is disposed, the sterilizer will not allow it to be inserted again.

## Service Functions

The **Service Functions** button is reserved for use by ASP Service Representatives.

# System Configuration

Use the System Configuration screen to set sterilizer options. Selections on this screen allow you to set the volume of the alarm loudspeaker, the time interval before the screen backlight is turned off, the language used in displays and reports, and several access, report, and connection options. The sterilizer comes configured with factory-set defaults. If you want to change the default settings, select your preferred settings.

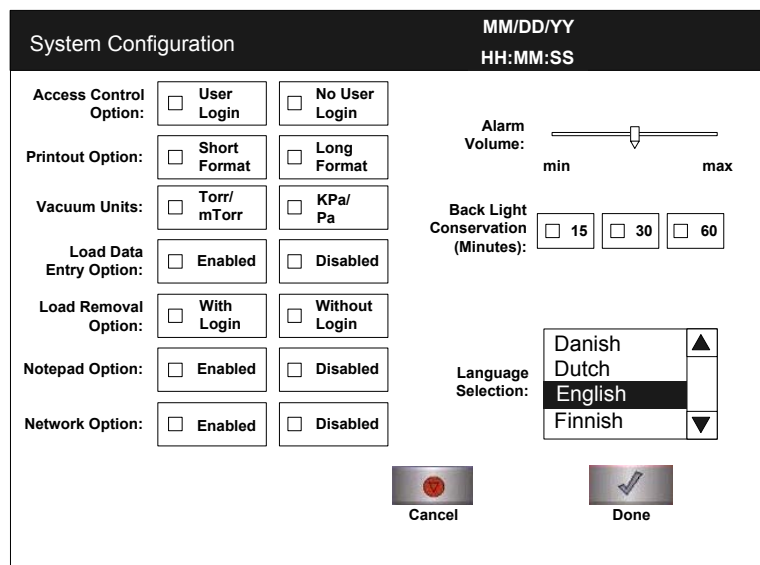

Figure 26. System Configuration.

## Access Control Option

**User Login** requires that a user identification and password be entered before the sterilizer can be loaded and run. This is the factory default setting.

**No User Login** allows any person to operate the sterilizer.

## Printout Option

**Short Format** instructs the sterilizer to print only the short report when a cycle is complete. This is the factory default setting.

**Long Format** instructs the sterilizer to print only the long report when a cycle is complete.

# 6 *Access Levels and Supervisor Tasks*

---

## Vacuum Units

**torr/mtorr** expresses vacuum measurements in torr and millitorr.

**kPa/Pa** expresses vacuum measurements in kilopascals and Pascals. This is the factory default setting.

## Load Data Entry Option

**Enabled** causes the Enter Load Item Data screen to be displayed after login. This is the factory default setting.

**Disabled** skips the Enter Load Item Data screen.

## Load Removal Option

**With Login** requires that a user enter a user identification and password to open the sterilizer door when a cycle is complete.

**Without Login** allows any person to open the sterilizer door when a cycle is complete. This is the factory default setting.

## Notepad Option

**Enabled** causes the Cycle Notes screen to be displayed after login. This is the factory default setting.

**Disabled** skips the Cycle Notes screen.

## Network Option

**Enabled** allows the sterilizer to be connected to a network.

**Disabled** disables the network connection. This is the factory default setting.

## Alarm Volume

Touch the slider to adjust the volume of the alarm loudspeaker. Move the slider to the far left end to turn the alarm speaker off. The factory default setting is in the middle of the scale.

## Backlight Conservation

The lifetime of the touch screen backlight can be considerably increased if the sterilizer automatically turns it off when it is not in use.

Select **15**, **30**, or **60** minutes to set the length of time the backlight remains on after the screen was last touched. When the selected interval expires, the backlight is automatically turned off. Touch the screen to turn the backlight on again. The factory default setting is 15 minutes.

## Language Selection

Scroll through the list to select the language used in displays and printed reports. The factory default setting is English.

## Cancel/Done

To cancel system configuration, touch the **Cancel** button. When the system configuration settings are correct, touch the **Done** button on the second System Configuration screen.

## File Management

Use the File Management screen to select and display calibration files or diagnostic report files.

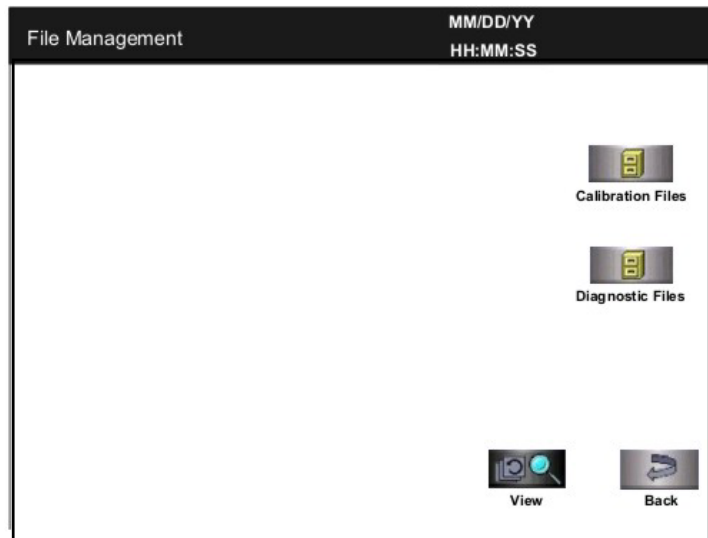

Figure 27. File Management.

### Calibration Files

Touch the **Calibration Files** button to display a list of calibration files created during a sterilizer calibration. Scroll through the list and touch the file name you wish to view. Touch the **View** button to display the selected calibration file. Touch the **Back** button to return to the Additional Utilities menu.

### Diagnostic Files

Touch the **Diagnostic Files** button to display a list of reports created by the Diagnostics function. Scroll through the list and touch the report you wish to view. Touch the **View** button to display the selected report. Touch the **Back** button to return to the Additional Utilities menu.



## User Administration

Use the User Administration screen to add, modify, or delete user names, passwords, and access levels. A button on this screen allows you to upload user information over your network from a remote host (if configured for network connection).

**4 Note:** *It is very important that you, as an administrator, keep track of your password. If you forget or lose your password, a service call is necessary for you to regain access to the supervisor area of the system.*

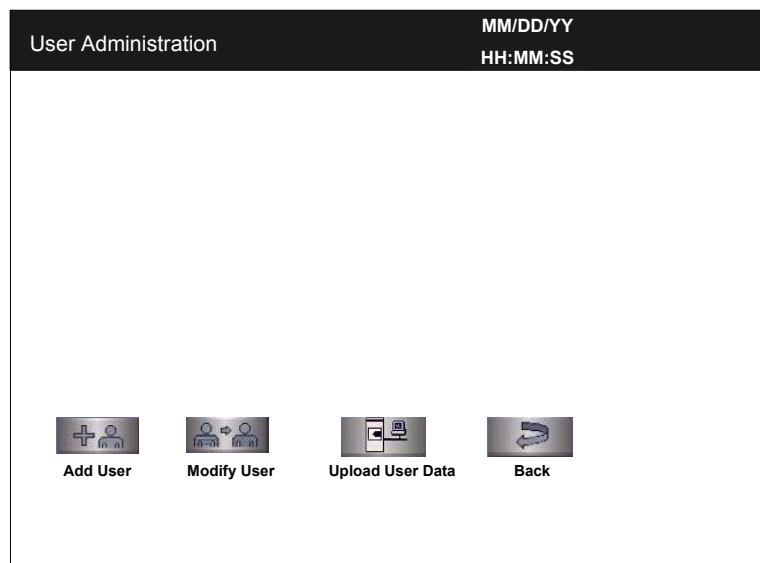

**Figure 28. User Administration.**

**Add User** displays the Add User screen. On this screen you can set up a new user's operator identification, password, and access level.

**Modify User** displays the Modify User screen. On this screen you can modify or delete an existing user's identification, password, and access level.

**Upload User Data** causes the sterilizer to receive a complete database file of user names, passwords, and access levels from a remote host over the network. (This function does not work if your sterilizer is not configured for a network connection.)

**Back** returns you to the Additional Utilities Menu.

# 6 Access Levels and Supervisor Tasks

## Add User

Use the Add User screen to enter a new user's identification, password, and access level.

Figure 29. Add User.

1. Enter the user's operator "identification" in the **Operator** field. The entry must be alpha-numeric, no more than 10 characters.
 

**4 Note:** *Operator and Password fields are case-sensitive.*
2. Enter the user's password in the **Password** field. The entry must be alpha-numeric, no more than 10 characters.
3. Scroll through the **Access Level** selections and select an appropriate access level. You may only choose "Operator" or "Supervisor."
4. Touch the **Cancel** button to exit this screen and return to the User Administration screen.
5. Touch the **Done** button when you have finished entering information for a new user.

## Modify User

Use the Modify User screen to modify an existing user's identification, password, and access level.

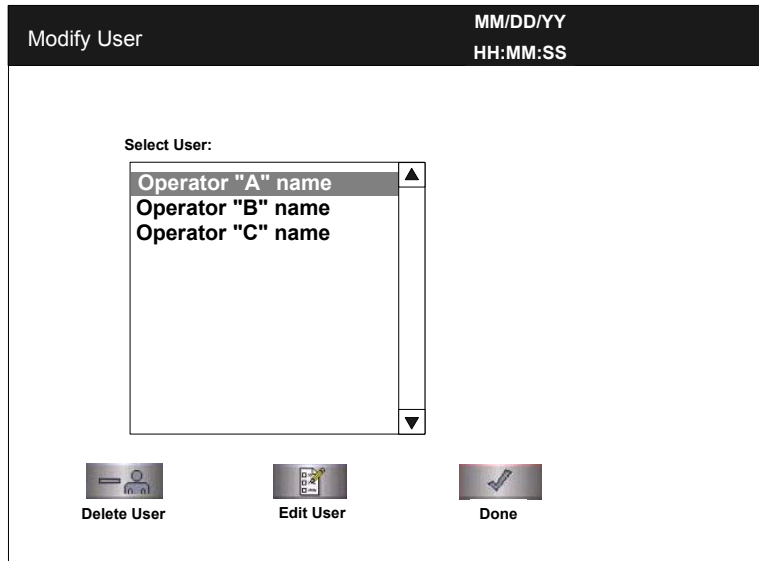

Figure 30. Modify User.

1. Select the user's name whose information you wish to modify.
2. The selected user's information is displayed in the Edit User screen.

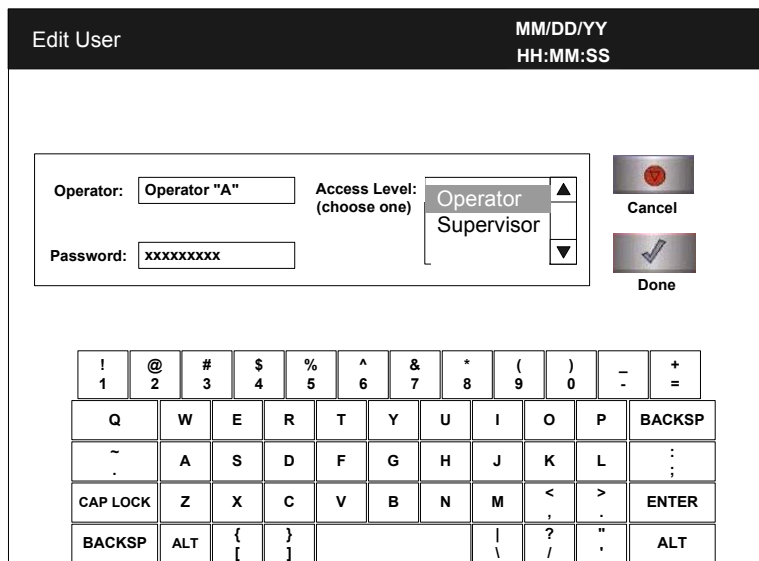

Figure 31. Edit User

- ◆ To modify the selected user's information, touch the **Edit User** button.

## 6 Access Levels and Supervisor Tasks

---

- ◆ To change the user's operator name, make changes in the **Operator** field.
  - ◆ To change the user's password, make changes in the **Password** field.
  - ◆ To change the user's access level, select the desired **Access Level**. You may only choose "Operator" or "Supervisor."
3. Touch the **Cancel** button to exit this screen and return to the Modify User screen.
  4. Touch the **Done** button when you have finished – the Modify User screen is displayed.
  5. To delete a user (revoke access to the sterilizer), select the user name and touch the **Delete User** button.

### Upload User Data

If your STERRAD<sup>®</sup> NX Sterilizer has been configured for network connectivity, you can also add up to 1000 user identifications by uploading them to the sterilizer from a remote computer or hospital network.

If you are not familiar with MS-DOS<sup>®</sup> applications, do not attempt to upload the user data. Contact your facility's network administrator for more information.

When the **Upload User Data** button is touched, the Upload User Data screen is displayed.

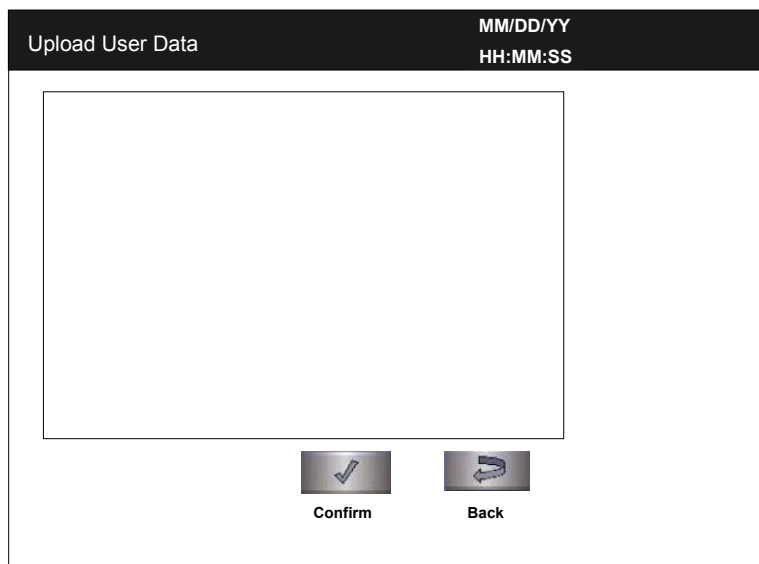

Figure 32. Upload User Data

## Steps to Upload a User Database

To upload a list of user identifications and passwords, perform the following steps:

1. Create an ASCII text file called "**users.rec**" that contains the user identifications, passwords, and access levels. Each entry should be separated by a comma only (no spaces). Example:

**USERNAME1,PASSWORD1,ACCESS-LEVEL1  
 USERNAME2,PASSWORD2,ACCESS-LEVEL2  
 USERNAME3,PASSWORD3,ACCESS-LEVEL3**

where:

- ◆ **USERNAME** must be alpha-numeric, no more than 10 characters
  - ◆ **PASSWORD** must be alpha-numeric, no more than 10 characters
  - ◆ **ACCESS-LEVEL** must be either 1, 2 (1=Operator, 2 = Supervisor)
2. From a PC running Microsoft® Windows, open the command prompt application (emulation of an MS-DOS® shell).
  3. Type: **cd <path>**  
 where <path> is the pathname to the **users.rec** file.
  4. Determine the sterilizer's IP address (refer to the *Network Settings* screen).
  5. Transfer the **users.rec** file to the sterilizer by typing: **TFTP <sterilizer IP address> PUT users.rec**  
 where <sterilizer IP address> is the address obtained from the Network Settings screen.
  6. On the sterilizer, touch the **Upload User Data** button. The information in the file will be displayed with the password concealed by "\*" characters.

You will receive an "INVALID STERRAD® NX DATABASE FILE" message if the password or user name is longer than the permissible length, you have specified an invalid access level, or you have used an invalid format.

7. Touch the **Confirm** button to accept the displayed data, logout the current user and return to the prior screen.

## Diagnostics

Touch the **Diagnostics** button to start automatic diagnostic testing of the sterilizer. When started, the diagnostics function prompts you to select one of two types of tests (either *Temperature* or *Other Tests*). If *Other Tests* is selected, the sterilizer runs ten operator-assisted tests of the sterilizer subsystems. You may skip one or more tests in the automatic sequence by touching the **Cancel** button when a test begins. This causes the program to advance to the next test in the sequence.

The ten tests and the sterilizer elements that are tested are listed in the order in which they occur in Table 6.

### Diagnostic Tests

Order	Test Name	What is tested	Average Time to Run*
1	Power Supply Test	High- and low-voltage power supplies and sensors.	30 sec.
2	Vacuum Test	Vacuum pump and pressure sensors.	2 min. 20 sec.
3	Plasma Test	Plasma electrical subsystem. Electrode integrity.	3 min. 40 sec.
4	Cassette Test	Cassette mechanical subsystem. Barcode reader.	5 min.
5	Door Test	Electric door lock.	20 sec.
6	H <sub>2</sub> O <sub>2</sub> Sensor Test	Ultraviolet lamp and detector.	20 sec.
7	Display Test	Touch screen calibration and function.	20 sec.
8	Printer Test	Printer function.	10 sec.
9	Fan Test	Fan speed and function.	10 sec.
10	Sound Test	Loudspeaker function and volume.	40 sec.

\* Times are approximate. If a failure is detected, the time may be extended.

The ten tests take approximately 13 minutes and 30 seconds to complete. When the series of tests is complete, the sterilizer creates and stores a diagnostics file and prints a report. When printing is complete, the Additional Utilities menu is displayed.

Chapter 7.

# Reports and Files

## Displayed Reports

Users with Operator-level access can display the System Summary file and Cycle History files. Users with Supervisor-level access can display the System Summary file, Cycle History files, as well as Calibration files and Diagnostic files.

All files that are displayed can be printed by touching the **Print** button on the file display screen.

### System Summary

The System Summary lists the configuration settings and factory-set parameters of the sterilizer and the control program.

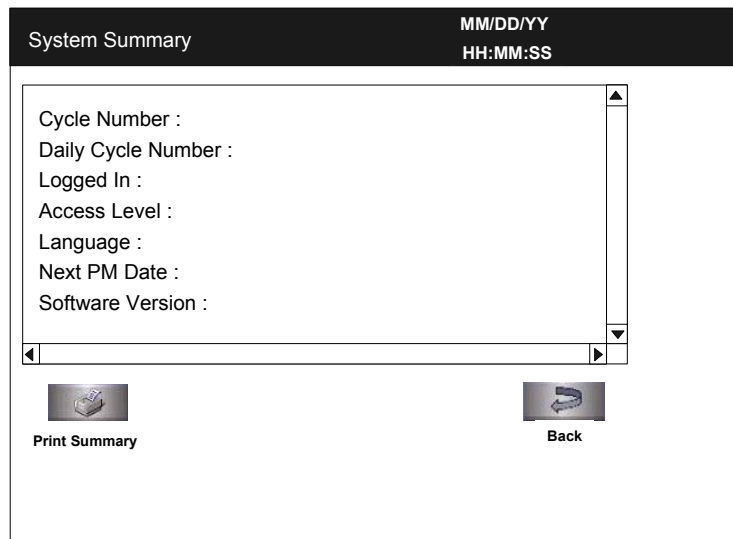

Figure 33. System Summary

**Print Summary** prints the contents of the System Summary file. Touch the scroll bars to scroll through the file. An explanation of the System Summary file is provided in the following table

**Back** returns you to the previous screen.

## System Summary File

Summary Item	Description	Comments
Cycle Number	Number of cycles since sterilizer was installed	Determined by sterilizer operation
Daily Cycle Number	Number of cycles since start of day (midnight)	Determined by sterilizer operation
Logged In	Name of currently logged-in operator	Determined by operator
Access Level	Access level of currently logged-in operator	Configurable by supervisor
Language	Current language setting	Configurable through System Configuration screen
Next PM Date	Date next planned maintenance service is due	Set by ASP Service
Software Version	Version of the sterilizer software	Set by factory; modifiable by ASP Service only
Cassette Position	Current position of the cassette	Determined by sterilizer operation
Cassette Exp. Date	Expiration date of currently installed cassette	Read from barcode on currently installed cassette
Cassette Barcode	Barcode data from currently installed cassette	Read from barcode on currently installed cassette
Access Control	Indicates whether user login is required	Configurable through System Configuration screen
Printout Option	Indicates print option – short or long format must be selected	Configurable through System Configuration screen
Vacuum Units	Scaling used to indicate vacuum: torr/millitorr or kilopascals/Pascals	Configurable through System Configuration screen
Load Data Entry	Indicates whether Load Item Data entry is required	Configurable through System Configuration screen
Load Removal	Indicates whether users must login to remove a load	Configurable through System Configuration screen



<b>Summary Item</b>	<b>Description</b>	<b>Comments</b>
Notepad	Indicates whether Cycle Notes entry is required	Configurable through System Configuration screen
Alarm Volume	Current setting of alarm volume	Configurable through System Configuration screen
Backlight Conservation	Current setting of backlight conservation timer	Configurable through System Configuration screen
Facility Name	Name of your facility	Configurable through System Configuration screen
Department Name	Name of your department	Configurable through System Configuration screen
Sterilizer ID	A unique identifier of your sterilizer	Configurable through System Configuration screen
Sterilizer Serial #	Serial number of your sterilizer	Set by ASP Service
Date Format	Current setting of date format	Configurable through Date and Time Settings screen
Time Format	Current setting of time format	Configurable through Date and Time Settings screen
Time Zone	Current setting of time zone	Configurable through Date and Time Settings screen
Remote Hostname*	Current setting of remote hostname	Configurable through Network Settings screen
Remote Port Number*	Current setting of remote port number	Configurable through Network Settings screen
Sterilizer Host Name*	Current setting of sterilizer host name	Configurable through Network Settings screen
Sterilizer IP Address*	Current setting of sterilizer IP address	Configurable through Network Settings screen
Name Server IP Address*	Current setting of name server IP address	Configurable through Network Settings screen
Gateway*	Current setting of gateway	Configurable through Network Settings screen
Resolver Domain Name*	Current setting of resolver domain name	Configurable through Network Settings screen
Subnet Mask*	Current setting of subnet mask	Configurable through Network Settings screen

# 7 Reports and Files

Summary Item	Description	Comments
System Board Revision	Revision number of system circuit board	Determined by sterilizer operation
Network Option	When enabled, network connection is supported	Configurable through System Configuration screen
Pressure Zeroing	Current setting for the pressure zeroing procedure	Set by ASP Service
Pressure Zeroing Time Interval	Current setting of the time interval of when to start the pressure zeroing procedure	Set by ASP Service
Pressure Zeroing Time of day	Current setting of the time of day to start the pressure zeroing procedure	Configurable through System Configuration screen
Pressure Zeroing Printout	Indicates whether printout is required	Configurable through System Configuration screen
IMS† Hardware	Current IMS hardware configuration of the sterilizer	Set by ASP Service
IMS Mode	Current setting of the IMS option	Set by ASP Service
IMS Printout	Indicates whether printout is required	Configurable through System Configuration screen

\* Not applicable if Network Option is disabled.

† Independent Monitoring System.

## Cycle History

Cycle history data is stored in the sterilizer’s memory. The memory holds data from the last 50 cycles. After 50 cycles are completed, the oldest cycle history record is overwritten with new data from the 51<sup>st</sup> cycle. If your sterilizer is configured with the optional network connection, cycle history data can be periodically uploaded to a host computer and preserved permanently if desired.

When you touch the **View Cycle History** button on any screen where the button appears, the program displays the Select Cycle History screen. The list box shows the cycle number, status, completion date and time, and reason for cancellation (if applicable) for all cycle history records currently in the sterilizer’s memory.

Touch the scroll bars to scroll through the list. Touch the line you wish to select.

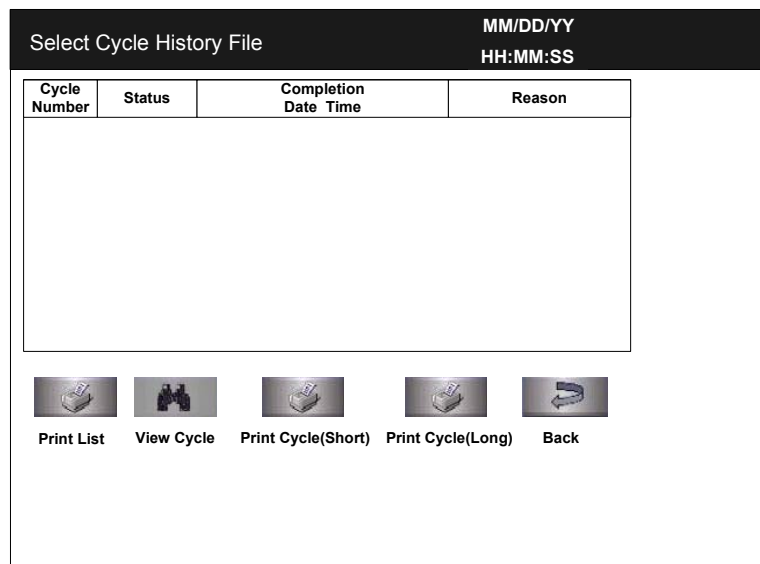

**Figure 34. Select Cycle History File.**

**Print List** prints a list of all cycle history files stored in the sterilizer.

**View Cycle** displays the selected Cycle History file on the screen.

**Print Cycle (Short)** prints a short-format report of the selected cycle history file.

**Print Cycle (Long)** prints a long-format report of the selected cycle history file.

**Back** returns you to the previous screen.

## Printed Reports

Every time a cycle is completed, a cycle completion report is printed. Depending upon how your sterilizer has been configured, the report will either be a short-format report or a long-format report. Both reports extract data from the cycle history record created by the cycle. The short-format report indicates the cycle status (Passed or Failed), date, time, operator and load information. The long-format report includes all of the data in the short report plus detailed information about each stage of the sterilization cycle.

### Short Report

The short-format report lists identifying information about the cycle, shows the cycle status, lists the date and duration of the cycle, and shows operator and load identifying information. The short-format report is useful for recordkeeping purposes and providing traceability of sterilized loads. An example of a short-format report is illustrated in the following figure.

```
Software Version: xxx
Facility Name:   xxxxxx
Department Name: xxxxxx
Sterilizer ID:   xxx
Serial #:        xxxxxxxx
Cycle #:         xxxx
Daily Cycle #:   xx
Operator:        Operator A
Load Items:      xxxxxxxx
Cycle Notes:     xxxxxxxx
Selected Cycle:  SHORT-CYCLE
Cycle Start Time: MM/DD/YY
                  HH:MM:SS
Cycle End Time:  MM/DD/YY
                  HH:MM:SS
Elapsed Time:    HH:MM:SS
CYCLE STATUS:   PASSED

PROCESS COMPLETE

Validated by: _____

Cassette Bar Code: xxxxxxxxx
NUMBER OF CYCLES AVAILABLE=X
```

Figure 35. Short Formal Report

## Long Report

The long-format report lists detailed information about the cycle, shows the cycle status, lists the date and duration of the cycle, shows operator and load identifying information, and provides detailed data about the operation of the sterilizer, including temperatures, pressures, plasma measurements, and sterilant concentrations throughout the cycle. The long-format report is useful for detailed cycle quality control and contains valuable diagnostics information for ASP Service Representatives.

An example of a long-format report is illustrated in the following three figures.

# 7 Reports and Files

<p>Software Version: xxx          Facility Name: xxxxxx          Department Name: xxxxxx          Sterilizer ID: xxx          Serial #: xxxxxxxx          Cycle #: xxxx          Daily Cycle #: xx          Operator: Operator A          Load Items: xxxxxxxxxx          Cycle Notes: xxxxxxxxxx          Selected Cycle: STNX-SHORT-CYCLE          Cycle Start Time: MM/DD/YY                                    HH:MM:SS          Cycle End Time: MM/DD/YY                                    HH:MM:SS          Elapsed Time: HH:MM:SS          Cycle Status: Passed</p> <p>(Warm Up Start)</p> <table> <thead> <tr> <th>Start Time</th> <th>End Time</th> <th>Stage Time</th> </tr> </thead> <tbody> <tr> <td>XX:XX:XX</td> <td>XX:XX:XX</td> <td>XX:XX:XX</td> </tr> <tr> <td>Sensor</td> <td>Max</td> <td>Min</td> </tr> <tr> <td>-----</td> <td>-----</td> <td>-----</td> </tr> <tr> <td>Pressure:</td> <td>&gt;30Torr</td> <td>&gt;30Torr</td> </tr> <tr> <td>Chamber Temp:</td> <td>xx.xC</td> <td>xx.xC</td> </tr> <tr> <td>Door Temp:</td> <td>xx.xC</td> <td>xx.xC</td> </tr> <tr> <td>Vaporizer Temp:</td> <td>xx.xC</td> <td>xx.xC</td> </tr> <tr> <td>Condenser Temp:</td> <td>xx.xC</td> <td>xx.xC</td> </tr> </tbody> </table> <p>(Delivery)</p> <table> <thead> <tr> <th>Start Time</th> <th>End Time</th> <th>Stage Time</th> </tr> </thead> <tbody> <tr> <td>XX:XX:XX</td> <td>XX:XX:XX</td> <td>XX:XX:XX</td> </tr> <tr> <td>Sensor</td> <td>Max</td> <td>Min</td> </tr> <tr> <td>-----</td> <td>-----</td> <td>-----</td> </tr> <tr> <td>Pressure:</td> <td>xxxTorr</td> <td>xxxTorr</td> </tr> <tr> <td>Chamber Temp:</td> <td>xx.xC</td> <td>xx.xC</td> </tr> <tr> <td>Door Temp:</td> <td>xx.xC</td> <td>xx.xC</td> </tr> <tr> <td>Vaporizer Temp:</td> <td>xx.xC</td> <td>xx.xC</td> </tr> <tr> <td>Condenser Temp:</td> <td>xx.xC</td> <td>xx.xC</td> </tr> <tr> <td>H2O2 Monitor(mg/l):</td> <td>x.x</td> <td>x.x</td> </tr> </tbody> </table> <p>(Vaporization Pumpdown 1)</p> <table> <thead> <tr> <th>Start Time</th> <th>End Time</th> <th>Stage Time</th> </tr> </thead> <tbody> <tr> <td>XX:XX:XX</td> <td>XX:XX:XX</td> <td>XX:XX:XX</td> </tr> <tr> <td>Sensor</td> <td>Max</td> <td>Min</td> </tr> <tr> <td>-----</td> <td>-----</td> <td>-----</td> </tr> </tbody> </table>	Start Time	End Time	Stage Time	XX:XX:XX	XX:XX:XX	XX:XX:XX	Sensor	Max	Min	-----	-----	-----	Pressure:	>30Torr	>30Torr	Chamber Temp:	xx.xC	xx.xC	Door Temp:	xx.xC	xx.xC	Vaporizer Temp:	xx.xC	xx.xC	Condenser Temp:	xx.xC	xx.xC	Start Time	End Time	Stage Time	XX:XX:XX	XX:XX:XX	XX:XX:XX	Sensor	Max	Min	-----	-----	-----	Pressure:	xxxTorr	xxxTorr	Chamber Temp:	xx.xC	xx.xC	Door Temp:	xx.xC	xx.xC	Vaporizer Temp:	xx.xC	xx.xC	Condenser Temp:	xx.xC	xx.xC	H2O2 Monitor(mg/l):	x.x	x.x	Start Time	End Time	Stage Time	XX:XX:XX	XX:XX:XX	XX:XX:XX	Sensor	Max	Min	-----	-----	-----	<p>Pressure: xxxTorr xxxTorr          Chamber Temp: xx.xC xx.xC          Door Temp: xx.xC xx.xC          Vaporizer Temp: xx.xC xx.xC          Condenser Temp: xx.xC xx.xC</p> <p>(Chamber Pumpdown 1)</p> <table> <thead> <tr> <th>Start Time</th> <th>End Time</th> <th>Stage Time</th> </tr> </thead> <tbody> <tr> <td>XX:XX:XX</td> <td>XX:XX:XX</td> <td>XX:XX:XX</td> </tr> <tr> <td>Sensor</td> <td>Max</td> <td>Min</td> </tr> <tr> <td>-----</td> <td>-----</td> <td>-----</td> </tr> <tr> <td>Pressure:</td> <td>xxxTorr</td> <td>xxxmTorr</td> </tr> <tr> <td>Chamber Temp:</td> <td>xx.xC</td> <td>xx.xC</td> </tr> <tr> <td>Door Temp:</td> <td>xx.xC</td> <td>xx.xC</td> </tr> <tr> <td>Vaporizer Temp:</td> <td>xx.xC</td> <td>xx.xC</td> </tr> <tr> <td>Condenser Temp:</td> <td>xx.xC</td> <td>xx.xC</td> </tr> </tbody> </table> <p>(Transfer 1)</p> <table> <thead> <tr> <th>Start Time</th> <th>End Time</th> <th>Stage Time</th> </tr> </thead> <tbody> <tr> <td>XX:XX:XX</td> <td>XX:XX:XX</td> <td>XX:XX:XX</td> </tr> <tr> <td>Sensor</td> <td>Max</td> <td>Min</td> </tr> <tr> <td>-----</td> <td>-----</td> <td>-----</td> </tr> <tr> <td>Pressure:</td> <td>xxxmTorr</td> <td>xxxmTorr</td> </tr> <tr> <td>Chamber Temp:</td> <td>xx.xC</td> <td>xx.xC</td> </tr> <tr> <td>Door Temp:</td> <td>xx.xC</td> <td>xx.xC</td> </tr> <tr> <td>Vaporizer Temp:</td> <td>xx.xC</td> <td>xx.xC</td> </tr> <tr> <td>Condenser Temp:</td> <td>xx.xC</td> <td>xx.xC</td> </tr> </tbody> </table> <p>(Pressure Check 1)</p> <table> <thead> <tr> <th>Start Time</th> <th>End Time</th> <th>Stage Time</th> </tr> </thead> <tbody> <tr> <td>XX:XX:XX</td> <td>XX:XX:XX</td> <td>XX:XX:XX</td> </tr> <tr> <td>Sensor</td> <td>Max</td> <td>Min</td> </tr> <tr> <td>-----</td> <td>-----</td> <td>-----</td> </tr> <tr> <td>Pressure:</td> <td>xxxTorr</td> <td>xxxmTorr</td> </tr> <tr> <td>Chamber Temp:</td> <td>xx.xC</td> <td>xx.xC</td> </tr> <tr> <td>Door Temp:</td> <td>xx.xC</td> <td>xx.xC</td> </tr> <tr> <td>Vaporizer Temp:</td> <td>xx.xC</td> <td>xx.xC</td> </tr> <tr> <td>Condenser Temp:</td> <td>xx.xC</td> <td>xx.xC</td> </tr> </tbody> </table> <p>(Diffusion 1)</p> <table> <thead> <tr> <th>Start Time</th> <th>End Time</th> <th>Stage Time</th> </tr> </thead> <tbody> <tr> <td>XX:XX:XX</td> <td>XX:XX:XX</td> <td>XX:XX:XX</td> </tr> <tr> <td>Sensor</td> <td>Max</td> <td>Min</td> </tr> <tr> <td>-----</td> <td>-----</td> <td>-----</td> </tr> <tr> <td>Pressure:</td> <td>xxxTorr</td> <td>xxxTorr</td> </tr> <tr> <td>Chamber Temp:</td> <td>xx.xC</td> <td>xx.xC</td> </tr> <tr> <td>Door Temp:</td> <td>xx.xC</td> <td>xx.xC</td> </tr> <tr> <td>Vaporizer Temp:</td> <td>xx.xC</td> <td>xx.xC</td> </tr> <tr> <td>Condenser Temp:</td> <td>xx.xC</td> <td>xx.xC</td> </tr> </tbody> </table>	Start Time	End Time	Stage Time	XX:XX:XX	XX:XX:XX	XX:XX:XX	Sensor	Max	Min	-----	-----	-----	Pressure:	xxxTorr	xxxmTorr	Chamber Temp:	xx.xC	xx.xC	Door Temp:	xx.xC	xx.xC	Vaporizer Temp:	xx.xC	xx.xC	Condenser Temp:	xx.xC	xx.xC	Start Time	End Time	Stage Time	XX:XX:XX	XX:XX:XX	XX:XX:XX	Sensor	Max	Min	-----	-----	-----	Pressure:	xxxmTorr	xxxmTorr	Chamber Temp:	xx.xC	xx.xC	Door Temp:	xx.xC	xx.xC	Vaporizer Temp:	xx.xC	xx.xC	Condenser Temp:	xx.xC	xx.xC	Start Time	End Time	Stage Time	XX:XX:XX	XX:XX:XX	XX:XX:XX	Sensor	Max	Min	-----	-----	-----	Pressure:	xxxTorr	xxxmTorr	Chamber Temp:	xx.xC	xx.xC	Door Temp:	xx.xC	xx.xC	Vaporizer Temp:	xx.xC	xx.xC	Condenser Temp:	xx.xC	xx.xC	Start Time	End Time	Stage Time	XX:XX:XX	XX:XX:XX	XX:XX:XX	Sensor	Max	Min	-----	-----	-----	Pressure:	xxxTorr	xxxTorr	Chamber Temp:	xx.xC	xx.xC	Door Temp:	xx.xC	xx.xC	Vaporizer Temp:	xx.xC	xx.xC	Condenser Temp:	xx.xC	xx.xC
Start Time	End Time	Stage Time																																																																																																																																																																																
XX:XX:XX	XX:XX:XX	XX:XX:XX																																																																																																																																																																																
Sensor	Max	Min																																																																																																																																																																																
-----	-----	-----																																																																																																																																																																																
Pressure:	>30Torr	>30Torr																																																																																																																																																																																
Chamber Temp:	xx.xC	xx.xC																																																																																																																																																																																
Door Temp:	xx.xC	xx.xC																																																																																																																																																																																
Vaporizer Temp:	xx.xC	xx.xC																																																																																																																																																																																
Condenser Temp:	xx.xC	xx.xC																																																																																																																																																																																
Start Time	End Time	Stage Time																																																																																																																																																																																
XX:XX:XX	XX:XX:XX	XX:XX:XX																																																																																																																																																																																
Sensor	Max	Min																																																																																																																																																																																
-----	-----	-----																																																																																																																																																																																
Pressure:	xxxTorr	xxxTorr																																																																																																																																																																																
Chamber Temp:	xx.xC	xx.xC																																																																																																																																																																																
Door Temp:	xx.xC	xx.xC																																																																																																																																																																																
Vaporizer Temp:	xx.xC	xx.xC																																																																																																																																																																																
Condenser Temp:	xx.xC	xx.xC																																																																																																																																																																																
H2O2 Monitor(mg/l):	x.x	x.x																																																																																																																																																																																
Start Time	End Time	Stage Time																																																																																																																																																																																
XX:XX:XX	XX:XX:XX	XX:XX:XX																																																																																																																																																																																
Sensor	Max	Min																																																																																																																																																																																
-----	-----	-----																																																																																																																																																																																
Start Time	End Time	Stage Time																																																																																																																																																																																
XX:XX:XX	XX:XX:XX	XX:XX:XX																																																																																																																																																																																
Sensor	Max	Min																																																																																																																																																																																
-----	-----	-----																																																																																																																																																																																
Pressure:	xxxTorr	xxxmTorr																																																																																																																																																																																
Chamber Temp:	xx.xC	xx.xC																																																																																																																																																																																
Door Temp:	xx.xC	xx.xC																																																																																																																																																																																
Vaporizer Temp:	xx.xC	xx.xC																																																																																																																																																																																
Condenser Temp:	xx.xC	xx.xC																																																																																																																																																																																
Start Time	End Time	Stage Time																																																																																																																																																																																
XX:XX:XX	XX:XX:XX	XX:XX:XX																																																																																																																																																																																
Sensor	Max	Min																																																																																																																																																																																
-----	-----	-----																																																																																																																																																																																
Pressure:	xxxmTorr	xxxmTorr																																																																																																																																																																																
Chamber Temp:	xx.xC	xx.xC																																																																																																																																																																																
Door Temp:	xx.xC	xx.xC																																																																																																																																																																																
Vaporizer Temp:	xx.xC	xx.xC																																																																																																																																																																																
Condenser Temp:	xx.xC	xx.xC																																																																																																																																																																																
Start Time	End Time	Stage Time																																																																																																																																																																																
XX:XX:XX	XX:XX:XX	XX:XX:XX																																																																																																																																																																																
Sensor	Max	Min																																																																																																																																																																																
-----	-----	-----																																																																																																																																																																																
Pressure:	xxxTorr	xxxmTorr																																																																																																																																																																																
Chamber Temp:	xx.xC	xx.xC																																																																																																																																																																																
Door Temp:	xx.xC	xx.xC																																																																																																																																																																																
Vaporizer Temp:	xx.xC	xx.xC																																																																																																																																																																																
Condenser Temp:	xx.xC	xx.xC																																																																																																																																																																																
Start Time	End Time	Stage Time																																																																																																																																																																																
XX:XX:XX	XX:XX:XX	XX:XX:XX																																																																																																																																																																																
Sensor	Max	Min																																																																																																																																																																																
-----	-----	-----																																																																																																																																																																																
Pressure:	xxxTorr	xxxTorr																																																																																																																																																																																
Chamber Temp:	xx.xC	xx.xC																																																																																																																																																																																
Door Temp:	xx.xC	xx.xC																																																																																																																																																																																
Vaporizer Temp:	xx.xC	xx.xC																																																																																																																																																																																
Condenser Temp:	xx.xC	xx.xC																																																																																																																																																																																

Figure 36. Long Format Report

(Plasma Pumpdown 1)			Vaporizer Temp: xx.xC    xx.xC		
Start Time	End Time	Stage Time	Condenser Temp: xx.xC	xx.xC	
XX:XX:XX	XX:XX:XX	XX:XX:XX	H2O2 Monitoring(mg/l):	x.x	x.x
Sensor	Max	Min			
-----	-----	-----			
Pressure:	>30Torr	>30Torr			
Chamber Temp:	xx.xC	xx.xC			
Door Temp:	xx.xC	xx.xC			
Vaporizer Temp:	xx.xC	xx.xC			
Condenser Temp:	xx.xC	xx.xC			
Max. Delivered Power:		xxx Watts			
Min. Delivered Power:		x Watts			
Plasma Time:		x:xx			
(Plasma 1)			(Vaporization Pumpdown 2)		
Start Time	End Time	Stage Time	Start Time	End Time	Stage Time
XX:XX:XX	XX:XX:XX	XX:XX:XX	XX:XX:XX	XX:XX:XX	XX:XX:XX
Sensor	Max	Min	Sensor	Max	Min
-----	-----	-----	-----	-----	-----
Pressure:	xxxTorr	xxxTorr	Pressure:	xxxTorr	xxxTorr
Chamber Temp:	xx.xC	xx.xC	Chamber Temp:	xx.xC	xx.xC
Door Temp:	xx.xC	xx.xC	Door Temp:	xx.xC	xx.xC
Vaporizer Temp:	xx.xC	xx.xC	Vaporizer Temp:	xx.xC	xx.xC
Condenser Temp:	xx.xC	xx.xC	Condenser Temp:	xx.xC	xx.xC
Max. Delivered Power:		xxx Watts			
Min. Delivered Power:		x Watts			
Plasma Time:		x:xx			
(Vent 1)			(Chamber Pumpdown 2)		
Start Time	End Time	Stage Time	Start Time	End Time	Stage Time
XX:XX:XX	XX:XX:XX	XX:XX:XX	XX:XX:XX	XX:XX:XX	XX:XX:XX
Sensor	Max	Min	Sensor	Max	Min
-----	-----	-----	-----	-----	-----
Pressure:	xxxmTorr	xxxmTorr	Pressure:	xxxTorr	xxxmTorr
Chamber Temp:	xx.xC	xx.xC	Chamber Temp:	xx.xC	xx.xC
Door Temp:	xx.xC	xx.xC	Door Temp:	xx.xC	xx.xC
Vaporizer Temp:	xx.xC	xx.xC	Vaporizer Temp:	xx.xC	xx.xC
Condenser Temp:	xx.xC	xx.xC	Condenser Temp:	xx.xC	xx.xC
(Delivery)			(Transfer 2)		
Start Time	End Time	Stage Time	Start Time	End Time	Stage Time
XX:XX:XX	XX:XX:XX	XX:XX:XX	XX:XX:XX	XX:XX:XX	XX:XX:XX
Sensor	Max	Min	Sensor	Max	Min
-----	-----	-----	-----	-----	-----
Pressure:	xxxTorr	xxxTorr	Pressure:	xxxmTorr	xxxmTorr
Chamber Temp:	xx.xC	xx.xC	Chamber Temp:	xx.xC	xx.xC
Door Temp:	xx.xC	xx.xC	Door Temp:	xx.xC	xx.xC
Vaporizer Temp:	xx.xC	xx.xC	Vaporizer Temp:	xx.xC	xx.xC
Condenser Temp:	xx.xC	xx.xC	Condenser Temp:	xx.xC	xx.xC
(Pressure Check 2)					
Start Time	End Time	Stage Time			
XX:XX:XX	XX:XX:XX	XX:XX:XX			
Sensor	Max	Min			
-----	-----	-----			
Pressure:	xxxTorr	xxxTorr			
Chamber Temp:	xx.xC	xx.xC			
Door Temp:	xx.xC	xx.xC			
Vaporizer Temp:	xx.xC	xx.xC			
Condenser Temp:	xx.xC	xx.xC			

Figure 37. Long Format Report (continued).

# 7 Reports and Files

(Diffusion 2) Start Time            End Time Stage Time XX:XX:XX            XX:XX:XX    XX:XX:XX Sensor                Max        Min -----                -----        ----- Pressure:            xxxTorr    xxxTorr Chamber Temp:    xx.xC     xx.xC Door Temp:         xx.xC     xx.xC Vaporizer Temp:   xx.xC     xx.xC Condenser Temp:   xx.xC     xx.xC			Process Complete  Validated by: _____  Cassette Bar Code: XXXXXXXXXXXX Number of Cycles Available=X
(Plasma Pumpdown 2) Start Time            End Time Stage Time XX:XX:XX            XX:XX:XX    XX:XX:XX Sensor                Max        Min -----                -----        ----- Pressure:            xxxTorr    xxxTorr Chamber Temp:    xx.xC     xx.xC Door Temp:         xx.xC     xx.xC Vaporizer Temp:   xx.xC     xx.xC Condenser Temp:   xx.xC     xx.xC			
(Plasma 2) Start Time            End Time Stage Time XX:XX:XX            XX:XX:XX    XX:XX:XX Sensor                Max        Min -----                -----        ----- Pressure:            xxxmTorr   xxxmTorr Chamber Temp:    xx.xC     xx.xC Door Temp:         xx.xC     xx.xC Vaporizer Temp:   xx.xC     xx.xC Condenser Temp:   xx.xC     xx.xC Max. Delivered Power:        xxx Watts Min. Delivered Power:        x Watts Plasma Time:                    x:xx			
(Final Vent) Start Time            End Time Stage Time XX:XX:XX            XX:XX:XX    XX:XX:XX Sensor                Max        Min -----                -----        ----- Pressure:            xxxTorr    xxxmTorr Chamber Temp:    xx.xC     xx.xC Door Temp:         xx.xC     xx.xC Vaporizer Temp:   xx.xC     xx.xC Condenser Temp:   xx.xC     xx.xC Max. Delivered Power:        xxx Watts Min. Delivered Power:        x Watts Plasma Time:                    x:xx			

Figure 38. Long Format Report (continued).



# Files

The STERRAD® NX™ Sterilizer creates, stores, displays, prints, and can upload over a network several files of sterilizer and cycle-related data. These files include cycle history files. Each file is explained in the following sections.

## Cycle History Files

Cycle history files contain very detailed information about each sterilization cycle. The files include identifying information about the operator, load, time, date, cycle duration information, stage-by-stage data from the sensors and controls, and related technical items. Information is extracted from the cycle history file to produce the short-format report and the long-format report. The cycle history file contains information that is vital to a facility’s recordkeeping and traceability procedures. The sterilizer’s memory holds data from the last 50 cycles.

Cycle history files can be viewed and printed by users with Operator-level access.

The following figure features an example of a Cycle Profile Graph that may be viewed for each cycle run by the sterilizer. This graph depicts plots of the chamber pressure, vaporizer pressure and hydrogen peroxide pressure. From the Select Cycle History File screen, pressing the **View Cycle** button will display the Cycle History screen. This screen shows the cycle data for the sterilization cycle. The Cycle History screen also contains a **Cycle History Graph** button that will display the Cycle Graph.

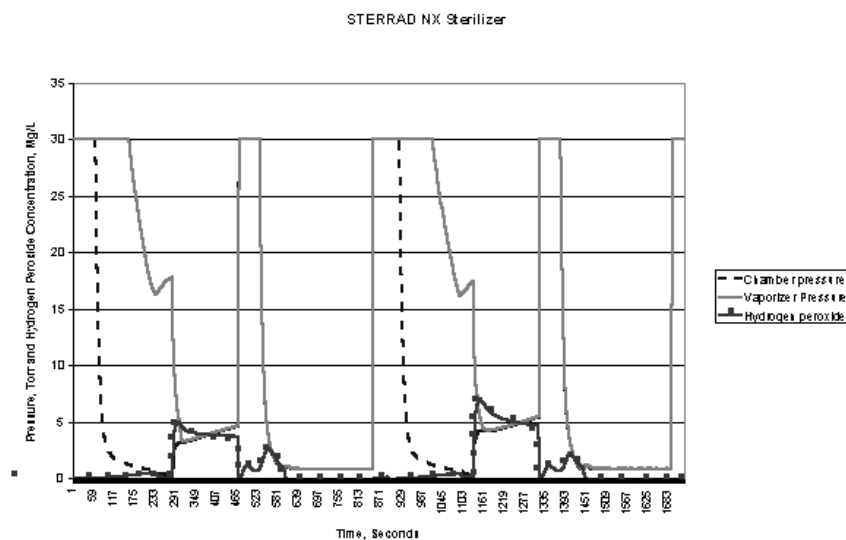

Figure 39. Cycle Profile - Standard Cycle.

## **Calibration Files**

Calibration files are generated every time the sterilizer is recalibrated. The files contain details about the inputs and outputs from calibrated sensors. This information ensures that the sterilizer is operating within its calibration limits and is useful to ASP Service Representatives when performing maintenance or service.

Calibration files can only be viewed and printed by users with Supervisor-level access.

Examples of a temperature calibration report, a thermistor resistance adjustment report, and a hydrogen peroxide monitor calibration report are illustrated in the following three figures.

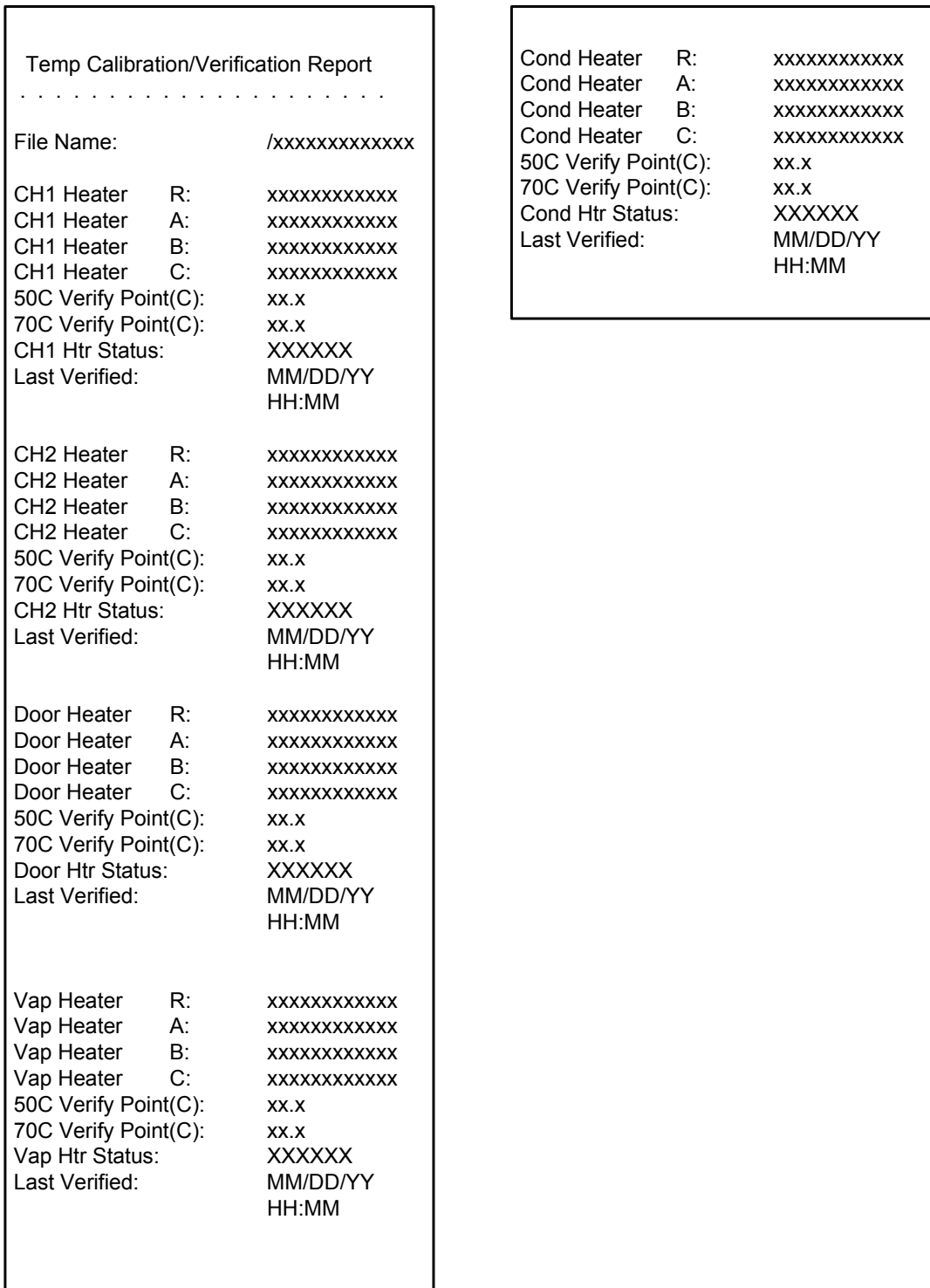

Figure 40. Temperature Calibration Report Example.

```

                                Thermistor Resistance
                                Adjustment Report
                                .....
File Name:      temprxxxxxxxxx
Last Verified:  MM/DD/YY
                HH:MM
Door:
Rprecision:    xxxxx Ohm
Rmeasured:     xxxxx Ohm
Rdiff:         xxxxx Ohm
Status:        Passed

Chamber 1:
Rprecision:    xxxxx Ohm
Rmeasured:     xxxxx Ohm
Rdiff:         xxxxx Ohm
Status:        Passed

Chamber 2:
Rprecision:    xxxxx Ohm
Rmeasured:     xxxxx Ohm
Rdiff:         xxxxx Ohm
Status:        Passed

Vaporizer:
Rprecision:    xxxxx Ohm
Rmeasured:     xxxxx Ohm
Rdiff:         xxxxx Ohm
Status:        Passed

Condenser:
Rprecision:    xxxxx Ohm
Rmeasured:     xxxxx Ohm
Rdiff:         xxxxx Ohm
Status:        Passed

```

Figure 41. Thermistor Resistance Adjustment Report Example.

H2O2 Monitor Calibration	
.....	
H2O2 Monitor	A: x.xxexx
H2O2 Monitor	B: x.xxexx
H2O2 Monitor	C: x.xxexx
H2O2 Monitor	Passed
Last Verified:	MM/DD/YY HH:MM:SS

**Figure 42. Hydrogen Peroxide Monitor Calibration Report Example.**

## Diagnostic Files

Diagnostic files are created by the diagnostics tests that are available only to users with Supervisor-level access. The files contain details about the tests and the outcomes (Passed or Failed) of each. This information is useful to ASP Service Representatives when performing maintenance or service.

Diagnostic files can only be viewed and printed by users with Supervisor-level access.

An example of a Diagnostic file is illustrated in the following figure.

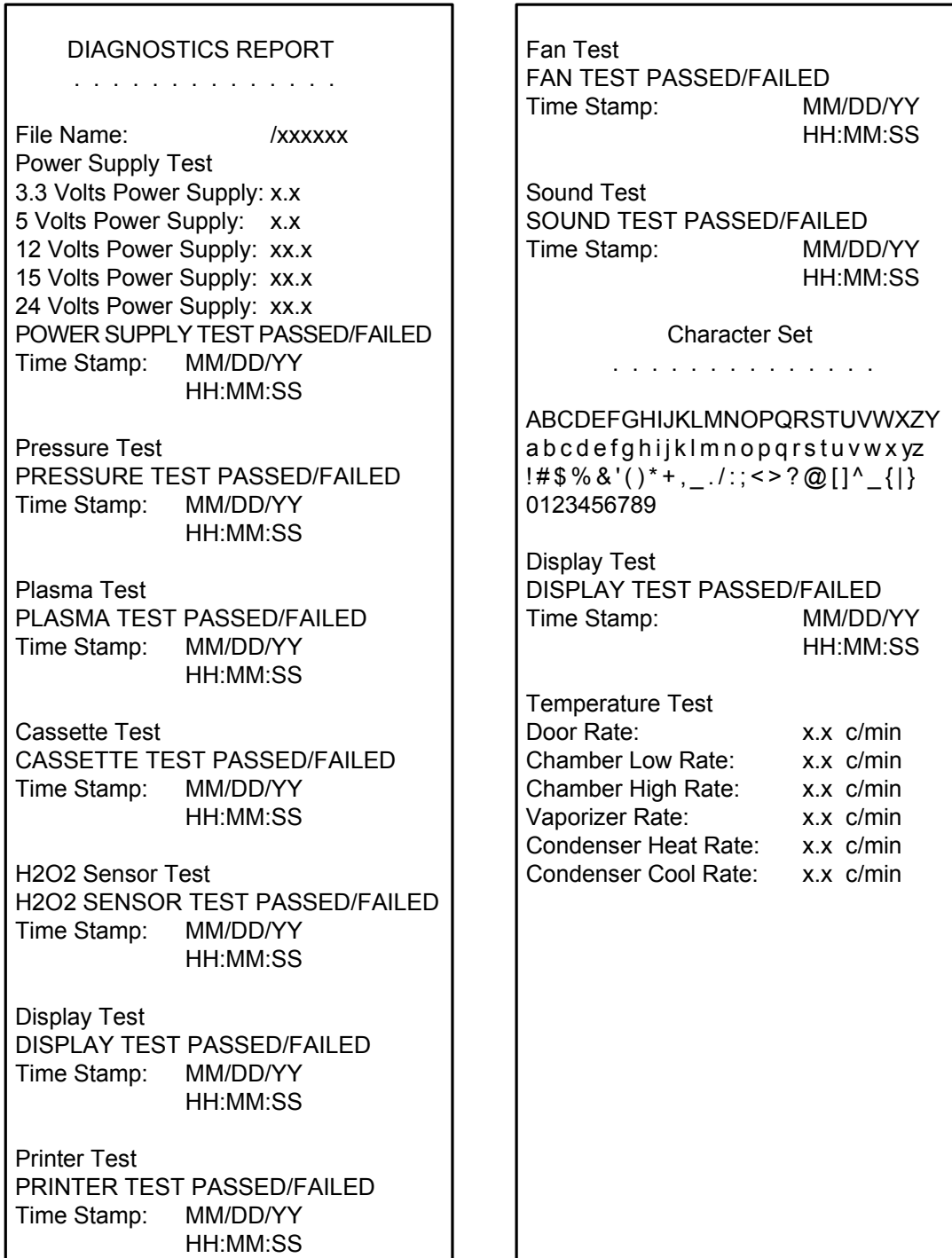

Figure 43. Diagnostic File Example.

## Chapter 8.

# Maintenance

***4 Note:** Repairs and adjustments should only be attempted by experienced technicians who are fully trained to maintain and repair the STERRAD® NX™ Sterilizer. Use of unauthorized parts for maintenance or repair could cause personal injury, result in costly damage, or sterilizer malfunction and voids the warranty.*

## Automatic Maintenance

Some maintenance procedures are performed automatically by the sterilizer software. The user does not have to perform any task to start an automatic maintenance procedure. There are two automatic maintenance procedures controlled by the software, they are:

- ◆ Pressure Zeroing
- ◆ Automatic Lamp Adjustment

### Pressure Zeroing

Periodically, the sterilizer will need to adjust the pressure transducers to ensure that they are operating within the required parameters.

When the operator presses the **Touch Screen to Start** screen, and if the sterilizer is within two days of its automatic pressure zeroing function, a “Pressure Zeroing Recommended” warning message will be displayed, notifying the operator that the Pressure Zeroing function should be run. If a Pressure Zeroing procedure has not been performed by the operator within the required time interval, a “Pressure Zeroing Required” warning message will be displayed on the **System Ready** screen. If this occurs, the operator will be unable to start a cycle. A Supervisor will be required to successfully perform the Pressure Zeroing procedure.

Pressure Zeroing Report	
.....	
Time Stamp	MM/DD/YY HH:MM
Result:	[PASS/FAIL]
Chamber Offset:	xx mTorr
Vaporizer Offset:	xx mTorr
Chamber 1 Temperature:	xx.x C
Chamber 2 Temperature:	xx.x C
Vaporizer Temperature:	xx.x C
Door Temperature:	xx.x C
Condenser Temperature:	xx.x C
Chamber Pressure:	xx mTorr
Vaporizer Pressure:	xx mTorr
Reference Pressure:	xx mTorr

Figure 44. Pressure Zeroing Report.

## Automatic Lamp Adjustment

When the sterilizer shows the System Ready screen, the message “Auto Adjustment in Progress” will be displayed while the sterilizer adjusts the intensity of the UV lamp. This function can take between 5 and 40 minutes to complete. The automatic adjustment will take place if the lamp voltage is below a preset limit.



## Manual Maintenance

The following maintenance procedures are performed by the user.:

- ◆ Disposing of cassettes.
- ◆ Inserting a new cassette disposal box.
- ◆ Replacing the printer paper roll.
- ◆ Cleaning the sterilizer exterior.
- ◆ Cleaning the hydrogen peroxide monitor detector lens.
- ◆ Replacing the air filter.
- ◆ Replacing the PCMCIA card (if desired).
- ◆ Disposing of a sterilizer.

These tasks are performed when needed. The printer paper is replaced when the roll is empty. The sterilizer exterior should be cleaned only when necessary. This chapter provides step-by-step instructions on how to perform these maintenance tasks. Inserting a cassette box follows the disposal section.

## Disposing of Cassettes

When a cassette is empty the sterilizer automatically moves it to the cassette disposal box in the collection drawer. The screen displays a message instructing you which actions to take next. When the cassette disposal box contains three cassettes, it is full, and you must dispose of the full cassette disposal box. For safety reasons, you **must** use the cassette disposal box to dispose of cassettes. Never reuse a cassette disposal box. Once a cassette disposal box has been removed from the drawer, a new cassette disposal box must be assembled and inserted in the drawer.

### Removing a Cassette Disposal Box



**CAUTION! HYDROGEN PEROXIDE MAY BE PRESENT.**

Wear latex, PVC (vinyl), or nitrile gloves. This will protect you from contact with any residual hydrogen peroxide that may be present in the cassettes.

1. Pull open the cassette drawer.
2. Lift the disposal box of used cassettes out of the drawer.

3. Fold the flaps over the top of the box. Push the tab of one flap into the slot of the other flap.

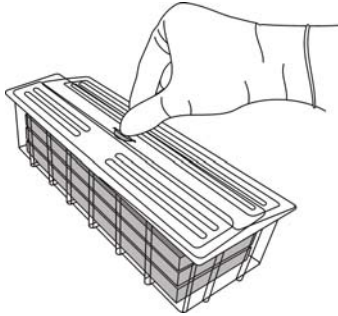

Figure 46. Push Tab Into Slots

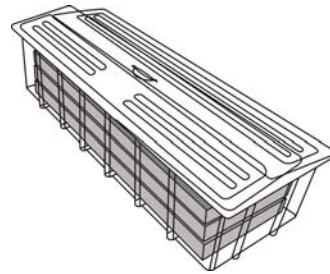

Figure 47. Closed Box Can Now Be Discarded

4. The closed box is now ready for disposal. It can be discarded as directed by your facility's disposal procedures.
5. Install a new cassette disposal box in the cassette drawer.

## Inserting a New Cassette Disposal Box

After disposing of a used cassette disposal box, following your facility's policy, a new box must be assembled and inserted into the cassette collection drawer.

1. Remove a new, unused cassette disposal box from the packaging.
2. Place the box inside the drawer making sure the arrow on the bottom of the box faces away from you.

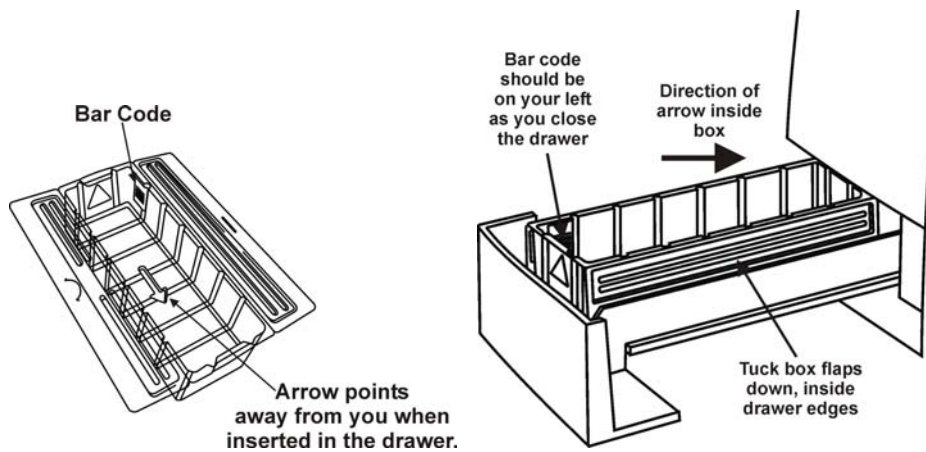

Figure 45. Correct Placement of Cassette Box in Drawer. Notice the Direction of the Arrow in the Box.

3. Tuck the flaps on the box inside the drawer edges. Close the drawer.

## Replacing Printer Paper

When the printer paper roll is empty, the sterilizer displays a message “Printer is out of paper. Please load a new roll.”

1. Open the printer by pressing the top button. The printer door drops forward.

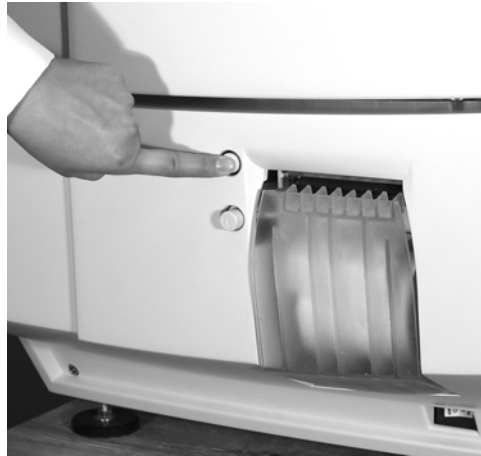

**Figure 46. Open the Printer Door.**

2. The empty paper roll rests on the bottom of the printer door. Remove the empty roll.

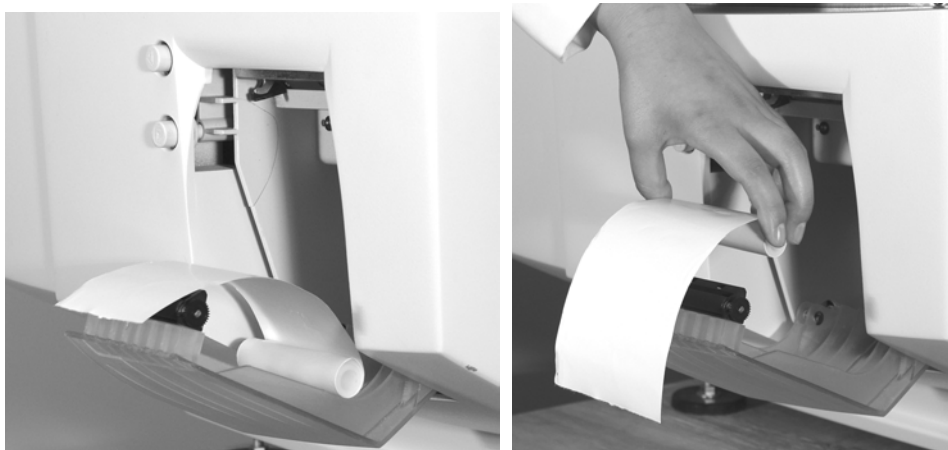

**Figure 47. Remove the Empty Paper Roll.**

3. Insert a new paper roll as shown in the following figure. The paper should feed from the top of the roll.



**Figure 48. Insert a New Paper Roll.**

4. Pull a short length of paper over the top of the printer door.
5. Align the paper so that it fits between the two paper guides on the top of the printer door.

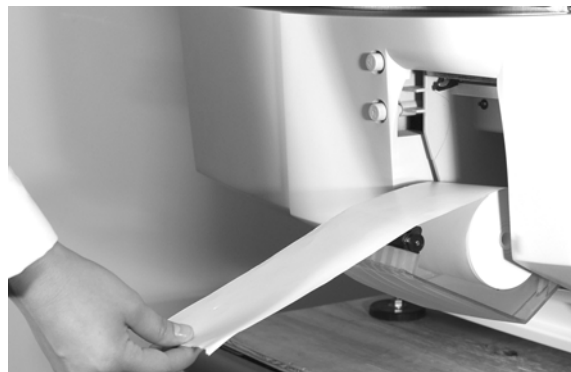

**Figure 49. and Pull the Paper Over the Top of the Door and Align the Paper Between the Guides.**

6. Hold the paper in place as you push the door shut.



**Figure 50. Hold the Paper as You Shut the Printer Door. Press the Paper Advance Button.**

7. Push the bottom button to advance the paper. Check the alignment of the paper and make certain it does not jam or misfeed.
8. When the paper has advanced normally, tear off the used strip in an upward direction. Paper replacement is now complete.

## Cleaning the Sterilizer Exterior

*4 Note: Do not attempt to clean the chamber, door, interior surfaces, shelves, or electrode. If these items need cleaning, in the U.S.A. call the ASP Customer Care Center. Internationally, call your local ASP Customer Support Representative for assistance.*

The sterilizer exterior can be cleaned with a soft cloth and a mild, nonabrasive detergent solution if necessary. When cleaning the sterilizer exterior, follow these guidelines:

1. Turn off the power to the sterilizer before cleaning the exterior.
2. Never allow cleaning solution or water to enter the interior or chamber. Moisten a cloth with nonabrasive detergent solution and use the damp cloth to clean the surfaces.
3. Do not spray cleaning solution directly on the touch screen. Use a dampened cloth to clean the screen.
4. If you have any questions about proper cleaning techniques, in the U.S.A. please call the ASP Customer Care Center. Internationally, call your local ASP Customer Support Representative before proceeding. Failure to follow these guidelines may result in damage to the sterilizer and may void the warranty.

## Cleaning the Hydrogen Peroxide Monitor Detector Lens

The hydrogen peroxide monitor lens must be kept clean. Clean the lens once every three months or when an accumulation of debris is noted. The lens is shown in the following figure.

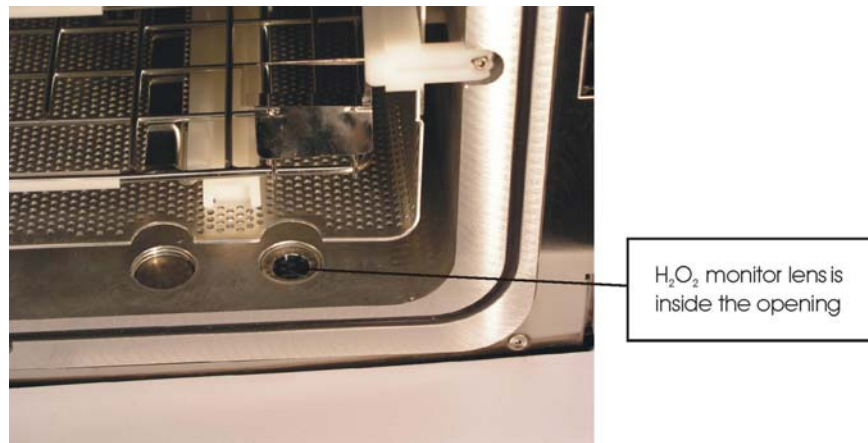

**Figure 51. Hydrogen Peroxide Monitor Lens.**

- ◆ Always use a lint-free cloth to clean the lens.
- ◆ Moisten the cloth with isopropyl alcohol. Never use an abrasive cleanser.

## Replacing the Air Filter

The air filter should be replaced when it is clogged with dust or debris. Periodically check the air filter for dust and debris. Refer to Appendix B for information on purchasing air filters for the STERRAD® NX™ Sterilizer.

To replace the air filter follow these guidelines:

1. Remove the nut that holds the flange of the air filter to the sterilizer. Save the nut.
2. Pull the air filter straight out. Do not pull it up or bend it (see the following figure).
3. Orient the new air filter as shown in the following figure.

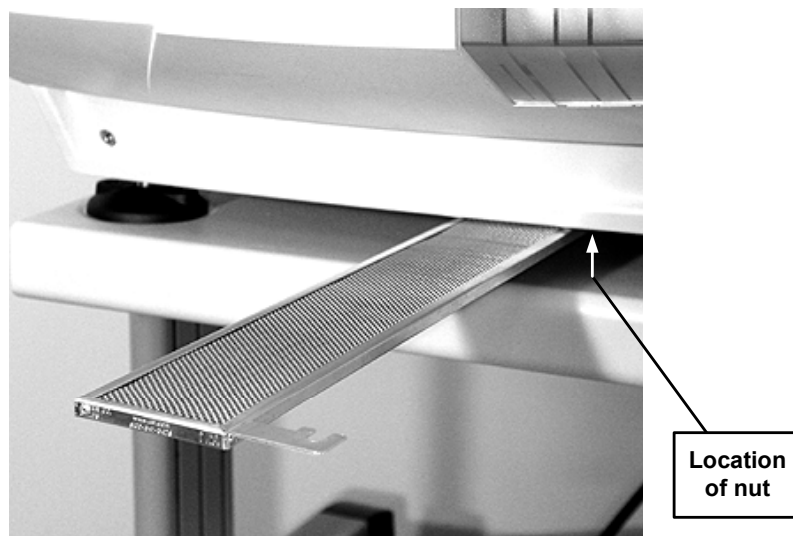

**Figure 52. Air Filter.**

4. Slide the new air filter into the sterilizer until it is firmly seated.
5. Replace and tighten the nut that attaches the air filter to the sterilizer.
6. Discard the used air filter as directed by your facility's policy.

## PCMCIA Card Handling and Replacement

The PCMCIA card contains the flash memory used to store cycle data. If you wish to save cycle data and do not have a network connection, the cycle data can be transferred directly from the PCMCIA card to a computer equipped with a PCMCIA card slot. To access the cycle data, perform the following steps:

1. Turn off the sterilizer.
2. Eject the PCMCIA card by pressing the eject button on the left of the card slot (see the following figure ).

The card can now be inserted into a computer to transfer the files. Refer to the operating instructions of your computer before installing a PCMCIA card in your computer. Once the cycle data is transferred, the PCMCIA card must be reinserted in the sterilizer by following these steps:

1. Examine the PCMCIA card.





**Figure 53. PCMCIA Card.**

2. Orient the PCMCIA card so that the side of the card shown in the following figure faces up.
3. Insert the card into the PCMCIA card slot as shown below.

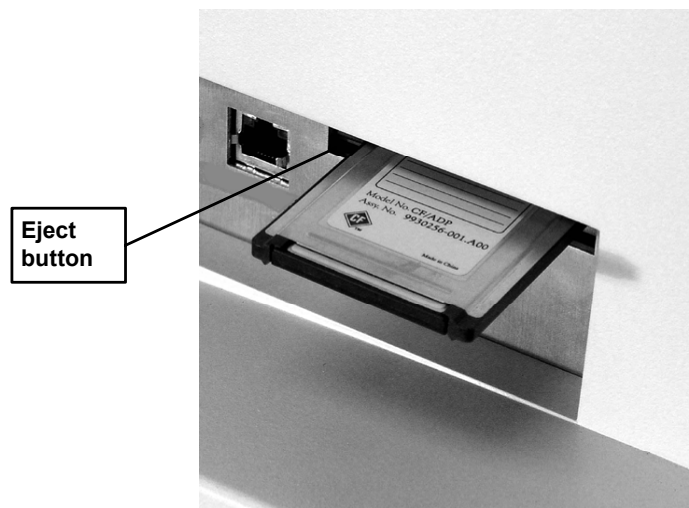

**Figure 54. PCMCIA Card Partially Inserted.**

4. Press the end of the PCMCIA card until the card is firmly seated in the slot (you will feel a “click” as the card is seated in the connector). A properly seated card is shown in the following figure.

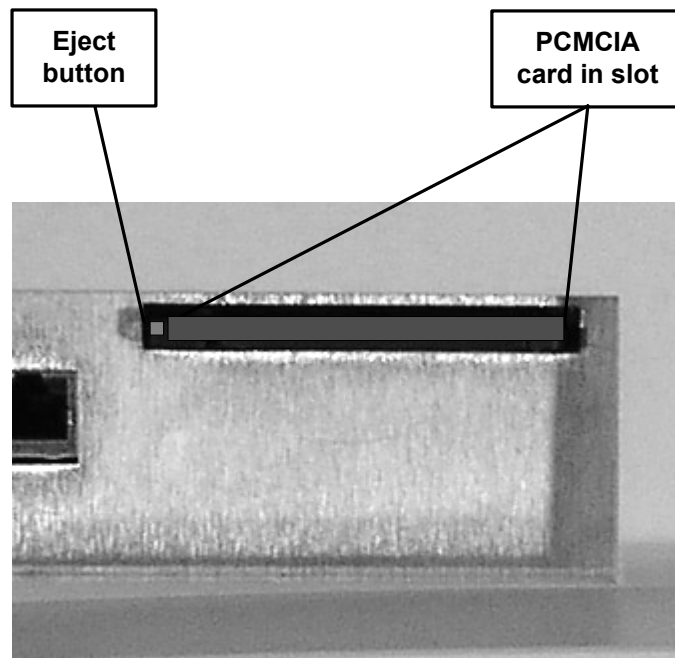

**Figure 55. PCMCIA Card Seated in the Slot.**

Alternatively, you may choose to save the PCMCIA card for your records. If you wish to save the card, replace the PCMCIA card in your sterilizer with a new card. Replacement cards are available from ASP and ordering information is provided in Appendix B of this user's guide.

**4 Note:** *The STERRAD NX Sterilizer will not operate unless the PCMCIA card is properly installed.*

## Sterilizer Disposal

In the event that disposal of the STERRAD NX Sterilizer is necessary, the machine may be returned to ASP, recycled with a local recycler, or disposed of in a local landfill. Disposal of infectious waste, electronic circuit boards, and cathode ray tubes (CRTs) are regulated by the U.S. Environmental Protection Agency and most international environmental agencies. Please ensure compliance with all International, Federal, State, and Local regulations before disposal. Contact your ASP Customer Care Representative for additional information.

Chapter 9.

# Troubleshooting

***4 Note:** Repairs and adjustments should only be made by ASP trained and authorized personnel.*

Most sterilizer operating problems are accompanied by a system message. These messages are useful in determining the source of the problem. In many cases you can take remedial actions to correct the source of the problem and thereby return the sterilizer to normal operation. In other cases, the problem is caused by a component failure that requires adjustment or repair by an ASP Service Representative. Call the ASP Customer Care Center at 1-888-STERRAD (1-888-783-7723). Internationally, call your local ASP Customer Support Representative.

## System Messages

Some system messages indicate conditions that you may be able to remedy. Refer the following table for details.

**4 Note:** *If a system message is not found in the following table, there is no remedy available that you may safely perform. Call the ASP Customer Care Center for assistance.*

System Message	Probable Cause	Suggested Remedy
CASSETTE ACCEPTED, POSITIONING...	The barcode has been read and the cassette has been positioned at cell 1.	None required.
CASSETTE DETECTED, VERIFYING...	A cassette has been detected and the barcode data is being read.	None required.
CASSETTE DID NOT INDEX	A cassette error occurred or the cassette did not index.	Run diagnostics.
CASSETTE EXPIRY FOUND DURING START CYCLE	The cassette was found to be expired when the Start Cycle button was pressed.	Dispose cassette and insert new cassette.
CASSETTE SYSTEM TIMEOUT	A timeout occurred in the cassette system.	Run diagnostics.
CASSETTE SYSTEM TIMEOUT ON INDEXING	The cassette could not index to the next cell.	Run diagnostics.
CYCLE CANCELED BY OPERATOR	The operator canceled the cycle.	None required.
DISPOSING CASSETTE...	A user disposed of the cassette or there are no remaining cells in the cassette.	None required.
H2O2 ADJUSTMENT FAILED	The maximum intensity of the UV lamp has been reached.	Call your ASP Customer Care Representative.
H2O2 ADJUSTMENT IN PROGRESS	The intensity of the UV lamp is being adjusted.	None required.
H2O2 BULB WARMING UP	The UV lamp is warming up.	None required.

<b>System Message</b>	<b>Probable Cause</b>	<b>Suggested Remedy</b>
H2O2 CURVE AREA TOO LOW	The calculated H <sub>2</sub> O <sub>2</sub> area under the time-temperature curve is less than the threshold value set in the CCF.	Run diagnostics. Call your ASP Customer Care Representative.
H2O2 RATE CONSTANT TOO HIGH	The calculated rate constant for H <sub>2</sub> O <sub>2</sub> is greater than the threshold value set in the CCF.	Run diagnostics. Call your ASP Customer Care Representative.
INJECT SETUP TIMEOUT	The time needed to initialize the injection stage has expired.	Run diagnostics. Call your ASP Customer Care Representative.
INJECT TIMEOUT	The time needed to inject hydrogen peroxide into the chamber has expired.	Run diagnostics. Call your ASP Customer Care Representative.
MEMORY CARD FULL	More than 50 cycle records are contained on the PCMCIA card. The next cycle record will overwrite the oldest cycle record.	Store cycle record information from PCMCIA card on an external PC.
PLEASE CLOSE DOOR	The door was opened while the system was warming up.	Close the door.
PLEASE INSERT NEW CASSETTE	No cassette was detected.	Insert a valid cassette.
PLEASE OPEN DOOR	Displayed after cycle completion. The load is ready for removal.	Open the door.
POWER FAIL CANCELLATION	A power failure occurred during a cycle.	Call your ASP Customer Care Representative.
POWER SUPPLY OUT OF RANGE	A power supply voltage is 20% higher or lower than specified.	Run diagnostics.
PRESSURE OUT OF RANGE (Low)	There is a pressure problem with the vacuum system.	Run diagnostics. Call your ASP Customer Care Representative.
SYSTEM FAILURE - CALL ASP.	A software error has occurred.	Call your ASP Customer Care Representative.
SYSTEM PROBLEM - CALL ASP!	A system error has occurred.	Call your ASP Customer Care Representative.

# 9 Troubleshooting

System Message	Probable Cause	Suggested Remedy
UNABLE TO LIGHT PLASMA. USE EXTRA CAUTION WHEN HANDLING THIS LOAD.	The plasma did not light during canceled cycle.	Run diagnostics. Call your ASP Customer Care Representative.
UNABLE TO OPEN ONE SECOND DATA FILE	A bad or missing PCMCIA compact flash memory.	Call your ASP Customer Care Representative.
VACUUM TIMEOUT	The time needed to evacuate the chamber has expired.	Run diagnostics. Call your ASP Customer Care Representative.
VENTING PLEASE WAIT...	The chamber is venting until it reaches atmospheric pressure.	None required.
WARMING UP, PLEASE WAIT...	The sterilizer is warming up.	None required.

## Diagnostic Messages

If an error occurs during operation, the sterilizer may allow you to run a diagnostic test immediately. When prompted to do so, touch the **Confirm** button to perform the diagnostic test. A diagnostic test displays and prints a diagnostic message when the test is completed. Some diagnostic messages indicate conditions that you may be able to remedy.

**Note:** *If a diagnostic message is not found in the following table, there is no remedy available that you may safely perform. Call the ASP Customer Care Center for assistance.*

Message	Probable Cause	Suggested Remedy
12 VOLT SUPPLY HIGH	12 volt DC supply > 14.4 volts.	Call your ASP Customer Care Representative.
12 VOLT SUPPLY LOW	12 volt DC supply < 9.6 volts.	Call your ASP Customer Care Representative.
15 VOLT SUPPLY HIGH	15 volt DC supply > 18 volts.	Call your ASP Customer Care Representative.
15 VOLT SUPPLY LOW	15 volt DC supply < 12 volts.	Call your ASP Customer Care Representative.
24 VOLT SUPPLY HIGH	24 volt DC supply > 28.8 volts.	Call your ASP Customer Care Representative.
24 VOLT SUPPLY LOW	24 volt DC supply < 19.2	Call your ASP Customer Care

<b>Message</b>	<b>Probable Cause</b>	<b>Suggested Remedy</b>
	volts.	Representative.
3.3 VOLT SUPPLY HIGH	3.3 volt DC supply > 3.96 volts.	Call your ASP Customer Care Representative.
3.3 VOLT SUPPLY LOW	3.3 volt DC supply < 2.64 volts.	Call your ASP Customer Care Representative.
5 VOLT SUPPLY HIGH	5 volt DC supply > 6 volts.	Call your ASP Customer Care Representative.
5 VOLT SUPPLY LOW	5 volt DC supply < 4 volts.	Call your ASP Customer Care Representative.
AIR PUMP SENSOR READ OFF	Air pump mechanical failure or air pump sensor failure.	Call your ASP Customer Care Representative.
AIR PUMP SENSOR READ ON	Air pump mechanical failure or air pump sensor failure.	Call your ASP Customer Care Representative.
ALARMS NOT HEARD	Alarms not functioning.	Verify annunciation of alarms. If the problem persists, call your ASP Customer Care Representative.
ATM SWITCH STUCK AT ATMOSPHERE	Atmospheric switch failure.	Call your ASP Customer Care Representative.
ATM SWITCH STUCK AT VACUUM	Atmospheric switch failure.	Call your ASP Customer Care Representative.
BAD MONITOR	UV monitor not functional.	Verify pathway between UV lamp and monitor is blocked. If the problem persists, call your ASP Customer Care Representative.
BARCODE FAILURE	Barcode scanner did not read barcode label.	Verify cassette is inserted correctly. Verify barcode. If the problem persists, Call your ASP Customer Care Representative.
CANNOT TURN PLASMA OFF	Plasma power out of specification.	Call your ASP Customer Care Representative.
CARRIAGE SENSOR FAILURE	Carriage sensor not functional.	Verify cassette is inserted all the way in. If problem persists, call your ASP Customer Care Representative.

# 9 Troubleshooting

Message	Probable Cause	Suggested Remedy
CASSETTE MOTOR FAILURE	Cassette motor not functional.	Verify cassette is inserted all the way in. If problem persists, call your ASP Customer Care Representative.
CASSETTE SYSTEM TIMEOUT	System could not communicate with delivery subsystem.	Call your ASP Customer Care Representative.
CHAMBER 1 TEMPERATURE RAILED HIGH	Thermistor circuit failure.	Call your ASP Customer Care Representative.
CHAMBER 1 TEMPERATURE RAILED LOW	Thermistor disconnected.	Call your ASP Customer Care Representative.
CHAMBER 2 TEMPERATURE RAILED HIGH	Thermistor circuit failure.	Call your ASP Customer Care Representative.
CHAMBER 2 TEMPERATURE RAILED LOW	Thermistor disconnected.	Call your ASP Customer Care Representative.
CHAMBER DELTA TOO BIG	The chamber temperature difference was larger than expected. A sensor or heater may have failed.	Call your ASP Customer Care Representative.
CHAMBER LOW/HIGH SELECT FAILURE	Chamber heater not functioning within specification.	Call your ASP Customer Care Representative.
CHAMBER PRESSURE RAILED HIGH	Chamber pressure always reads 30 torr.	Call your ASP Customer Care Representative.
CHAMBER PRESSURE RAILED LOW	Chamber pressure always reads 0 torr.	Call your ASP Customer Care Representative.
CHAMBER1 TEMPERATURE DID NOT DROP	Chamber heater will not shut off.	Call your ASP Customer Care Representative.
CHAMBER1 TEMPERATURE DID NOT RISE	Chamber heater/sensor not functioning within specification.	Call your ASP Customer Care Representative.
CHAMBER2 TEMPERATURE DID	Chamber heater will not shut off.	Call your ASP Customer Care Representative.



Message	Probable Cause	Suggested Remedy
NOT DROP		
CHAMBER2 TEMPERATURE DID NOT RISE	Chamber heater/sensor not functioning within specification.	Call your ASP Customer Care Representative.
COLLECTION BOX FAILURE – FULL	Collection box is not present or properly positioned.	Verify collection box is present and positioned properly. If problem persists, call your ASP Customer Care Representative.



**WARNING! HYDROGEN PEROXIDE MAY BE PRESENT.**

*Wear latex, PVC (vinyl), or nitrile gloves whenever handling disposed cassettes. Hydrogen peroxide liquid may be present on the cassettes.*

COLLECTION BOX FAILURE - NOT FULL	Disposed cassette did not end up in collection box.	Wear gloves and open collection box drawer and free up any jammed cassettes. If problem persists, call your ASP Customer Care Representative.
CONDENSER FAN NOT OFF	Condenser fan electrical failure.	Call your ASP Customer Care Representative.
CONDENSER FAN NOT ON	Condenser fan not functioning.	Call your ASP Customer Care Representative.
CONDENSER TEMPERATURE DID NOT DROP	Condenser heater will not shut off.	Call your ASP Customer Care Representative.
CONDENSER TEMPERATURE DID NOT RISE	Condenser heater/sensor not functioning within specification.	Call your ASP Customer Care Representative.
CONDENSER TEMPERATURE TOO HIGH	The condenser temperature was higher than expected. A sensor or heater may have failed.	Run diagnostics.
CONDENSER TEMPERATURE TOO LOW	The condenser temperature was lower than expected. A sensor or heater may have failed.	Run diagnostics.
CONDENSER TEMPERATURE RAILED HIGH	Thermistor circuit failure.	Call your ASP Customer Care Representative.

# 9 Troubleshooting

Message	Probable Cause	Suggested Remedy
CONDENSER TEMPERATURE RAILED LOW	Thermistor disconnected.	Call your ASP Customer Care Representative.
DELIVERY VALVE SENSOR READ CLOSED	Delivery valve mechanical failure.	Call your ASP Customer Care Representative.
DELIVERY VALVE SENSOR READ OPEN	Delivery valve mechanical failure.	Call your ASP Customer Care Representative.
DISPLAY TEST FAILURE	Touch panel not functioning.	Verify pressing of specified target. If problem persists, call your ASP Customer Care Representative.
DISPOSE FAILURE	Collection box not present.	Verify cassette was disposed into the collection box. If problem persists, call your ASP Customer Care Representative.
DOOR FAN STUCK OFF	Door fan not functioning.	Call your ASP Customer Care Representative.
DOOR FAN STUCK ON	Door fan not functioning.	Call your ASP Customer Care Representative.
DOOR SENSOR STUCK CLOSED	Door sensor electrical failure.	Call your ASP Customer Care Representative.
DOOR SENSOR STUCK OPEN	Door sensor electrical failure.	Call your ASP Customer Care Representative.
DOOR TEMPERATURE DID NOT DROP	Door heater will not shut off.	Call your ASP Customer Care Representative.
DOOR TEMPERATURE DID NOT RISE	Door heater/sensor not functioning within specification.	Call your ASP Customer Care Representative.
DOOR TEMPERATURE RAILED HIGH	Thermistor circuit failure.	Call your ASP Customer Care Representative.
DOOR TEMPERATURE RAILED LOW	Thermistor disconnected.	Call your ASP Customer Care Representative.
EJECT FAILURE	Cassette did not eject.	Verify cassette is not ejected. If problem persists, call your ASP Customer Care Representative.
FAILED TO EXTEND	Needle motor not functional.	Verify needles extend. If problem persists, call your ASP Customer

<b>Message</b>	<b>Probable Cause</b>	<b>Suggested Remedy</b>
NEEDLE		Care Representative.
FAILED TO RETRACT NEEDLE	Needle motor not functional.	Verify needles retract. If problem persists, call your ASP Customer Care Representative.
HIGH PLASMA POWER	Plasma power out of specification.	Run diagnostics. Call your ASP Customer Care Representative.
INLET COMMAND ALWAYS CLOSED	Inlet valve electrical failure.	Call your ASP Customer Care Representative.
INLET COMMAND ALWAYS OPEN	Inlet valve electrical failure.	Call your ASP Customer Care Representative.
LOW PLASMA POWER	Plasma power out of specification.	Run diagnostics. Call your ASP Customer Care Representative.
MAIN FAN STUCK OFF	Main fan not functioning.	Call your ASP Customer Care Representative.
NO PLASMA POWER	Plasma power out of specification.	Call your ASP Customer Care Representative.
OIL RETURN VALVE STUCK CLOSED	Oil return valve mechanical failure.	Call your ASP Customer Care Representative.
OIL RETURN VALVE STUCK OPEN	Oil return valve mechanical failure.	Call your ASP Customer Care Representative.
PRINTER TEST FAILURE	Printer not printing.	Verify data printed. If problem persists, call your ASP Customer Care Representative.
PUMP ALWAYS OFF	Vacuum pump electrical failure.	Call your ASP Customer Care Representative.
PUMP ALWAYS ON	Vacuum pump electrical failure.	Call your ASP Customer Care Representative.
UNABLE TO LOCK DOOR	Door lock mechanical failure.	Call your ASP Customer Care Representative.
VACUUM COMMAND ALWAYS OPEN	Vacuum valve mechanical failure.	Call your ASP Customer Care Representative.
VACUUM CONTROL VALVE STUCK CLOSED	Vacuum control valve mechanical failure.	Call your ASP Customer Care Representative.
VACUUM CONTROL VALVE STUCK OPEN	Vacuum control valve mechanical failure.	Call your ASP Customer Care Representative.

# 9 Troubleshooting

Message	Probable Cause	Suggested Remedy
VACUUM INSUFFICIENT FOR PLASMA	Leak in chamber or wet load in chamber.	Remove load. Verify door is closed. If problem persists, call your ASP Customer Care Representative.
VACUUM SENSOR STUCK CLOSED	Vacuum valve sensor failure.	Call your ASP Customer Care Representative.
VACUUM SENSOR STUCK OPEN	Vacuum valve sensor failure.	Call your ASP Customer Care Representative.
VAPORIZER PRESSURE RAILED HIGH	Vaporizer pressure always reads 200 torr.	Call your ASP Customer Care Representative.
VAPORIZER PRESSURE RAILED LOW	Vaporizer pressure always reads 0 torr.	Call your ASP Customer Care Representative.
VAPORIZER TEMPERATURE DID NOT DROP	Vaporizer heater will not shut off.	Call your ASP Customer Care Representative.
VAPORIZER TEMPERATURE DID NOT RISE	Vaporizer heater/sensor not functioning within specification.	Call your ASP Customer Care Representative.
VAPORIZER TEMPERATURE RAILED HIGH	Thermistor circuit failure.	Call your ASP Customer Care Representative.
VAPORIZER TEMPERATURE RAILED LOW	Thermistor disconnected.	Call your ASP Customer Care Representative.
VENT SENSOR STUCK CLOSED	Vent valve sensor failure.	Call your ASP Customer Care Representative.
VENT SENSOR STUCK OPEN	Vent valve sensor failure.	Call your ASP Customer Care Representative.
VENT VALVE COMMAND ALWAYS CLOSED	Vent valve electrical failure.	Call your ASP Customer Care Representative.
VENT VALVE COMMAND ALWAYS OPEN	Vent valve electrical failure.	Call your ASP Customer Care Representative.
VENT VALVE PARTIALLY OCCLUDED	Filter on vent valve needs cleaning or replacement.	Call your ASP Customer Care Representative.
VENT VALVE STUCK	Vent valve mechanical	Call your ASP Customer Care

<b>Message</b>	<b>Probable Cause</b>	<b>Suggested Remedy</b>
CLOSED	failure.	Representative.
VENT VALVE STUCK OPEN	Vent valve mechanical failure.	Call your ASP Customer Care Representative.

## **ASP Customer Care Center**

If you encounter a problem or a system message that is not covered in the this user's guide, do not attempt to perform repairs or adjustments to the STERRAD® NX™ Sterilizer. Call the ASP Customer Care Center for assistance in the USA at 1-888-STERRAD (1-888-783-7723) and internationally, call your local ASP Customer Support Representative.



Appendix A.

# **Warranties and Software License**

## **Advanced Sterilization Products Commercial Warranty**

The STERRAD<sup>®</sup> Sterilizer and reusable accessories supplied by Advanced Sterilization Products (ASP) are warranted to be free from defects in materials and workmanship for a period of one (1) year from the date of installation, when properly installed, maintained and used for their intended purpose. This warranty applies only to the original purchaser of the equipment and only if the equipment is used in the country to which it was originally shipped by Advanced Sterilization Products.

This warranty is null and void if service is attempted or performed by persons who are not authorized to do so by Advanced Sterilization Products. If, after examination by an ASP Service Representative, any portion of the unit is found to be defective within the period specified above, and ASP is satisfied that the failure was due to defective materials and/or workmanship, ASP will, at its option, repair or replace the defective parts without charge. This warranty is not valid for repair or replacement for defects due to external factors including, but not limited to, defective electrical installation or electrical/atmospheric disturbances. ASP reserves the right to make the necessary repair/replacement in its own factory, at any authorized repair station, or at the facilities of the purchaser of the equipment. Replacement items can be either new or remanufactured. Defective parts replaced under warranty shall become the property of ASP.

## **Advanced Sterilization Products Service Warranty**

Service repairs are warranted to be free from defects in materials and workmanship for a period of 90 days after the date of repair when serviced by an ASP Representative or authorized dealer.

This warranty is null and void if service is performed by persons who are not authorized to do so by Advanced Sterilization Products. If, after

examination by an ASP Service Representative, the previously repaired portion of the unit is found to be defective within the period specified above, and ASP is satisfied that the failure was due to defective materials and/or workmanship, ASP will, at its option, repair or replace the defective parts without charge. This warranty is not valid for repair or replacement for defects due to external factors including, but not limited to, defective electrical installation or electrical/atmospheric disturbances. ASP reserves the right to make the necessary repair in its own factory, at any authorized repair station, or at the facilities of the purchaser of the equipment. Replacement items can be either new or remanufactured. Defective parts replaced under warranty shall become the property of ASP.

THE EXPRESS WARRANTY ABOVE IS THE SOLE WARRANTY OBLIGATION OF ADVANCED STERILIZATION PRODUCTS, AND THE REMEDY PROVIDED ABOVE IS IN LIEU OF ANY AND ALL OTHER REMEDIES. THERE ARE NO OTHER AGREEMENTS, GUARANTEES OR WARRANTIES – ORAL OR WRITTEN – EXPRESSED OR IMPLIED, INCLUDING WITHOUT LIMITATION WARRANTY OF MERCHANTABILITY OR FITNESS FOR A PARTICULAR PURPOSE. ADVANCED STERILIZATION PRODUCTS SHALL HAVE NO LIABILITY WHATSOEVER FOR ANY IMPROPER USE OR UNAUTHORIZED SERVICE OR REPAIR.

## **Advanced Sterilization Products Software License**

Please read this license carefully.

You are purchasing the Advanced Sterilization Products (ASP) STERRAD Sterilization System. This system provides the STERRAD Operational Software in a magnetic media format that is designed to be used on the STERRAD<sup>®</sup> Sterilizer System only.

The STERRAD<sup>®</sup> Operational Software is protected by international copyrights, and is licensed to you for use only in the terms set forth below. Opening the packaging and/or using the STERRAD<sup>®</sup> Operational Software indicates your acceptance of these terms.

ASP grants you permission to use, annotate, copy, and print any single or multiple text portions, from the STERRAD<sup>®</sup> Operational Software, only for personal use, as needed to service or document the STERRAD<sup>®</sup> Sterilization System operation.

No other use of the STERRAD<sup>®</sup> Operational Software is granted. Unauthorized uses include, but are not limited to: incorporation into another software program or application, dissemination, reverse engineering, decompilation, modification, sub-licensing, selling, renting, leasing, lending, giving or in any other way transferring, by any means or in any medium, including telecommunication.



This license agreement is terminated if you tamper with the hydrogen peroxide container or use sources of hydrogen peroxide other than Certified ASP Hydrogen Peroxide containers in your STERRAD<sup>®</sup> Sterilizer. Any warranties associated with this STERRAD<sup>®</sup> Sterilizer are hereby disclaimed if such non-certified sources are used in your STERRAD<sup>®</sup> Sterilizer.

Your use of the STERRAD Operational Software in any unauthorized manner will constitute a breach of this agreement and subject you to civil penalties for such breach.

Advanced Sterilization Products  
a Johnson & Johnson company  
Division of Ethicon, Inc.  
33 Technology Drive  
Irvine, California 92618

1-888-STERRAD (1-888-783-7723)  
+ 1-949-581-5799 (internationally)



## Appendix B.

# Consumables, Accessories, and Additional Parts

Consumable Products	Product Code	Description
STERRAD <sup>®</sup> NX <sup>™</sup> Cassette	10133	5 cycles per cassette, 5 cassettes per case.
Thermal Printer Paper Roll	10305	12 rolls of replacement printer paper.
Cassette Disposal Box	10306	10 collection boxes per case.

Accessories	Product Code	Description
Barcode Reader	10308	Optional barcode scanner for tracking instruments and other information in the cycle history file.
Independent Monitoring System (IMS)	10307	For compliance with ISO 14937. The Independent Monitoring System (IMS) is an optional feature that may be purchased and installed on the sterilizer. It is an independent data collection system that can be used for system validation or requalification. All of the sensors are independent from the system sensors and the data collected from the IMS is identified separately from the system's one-second data.
Sterilizer Cart	10301	Cart with locking wheels.
Sterilizer Table	10303	Stationary table.

Additional Parts	Part Number
Air Filter	25-52646-001
PCMCIA Card	40-51513-001
Stylus	61-52645-001

# B Appendix

---

<b>STERRAD® Consumables</b>	<b>Product Code</b>
CycleSure® Biological Indicator	14324
STERRAD® SealSure® Chemical Indicator Tape	14202
STERRAD® Chemical Indicator Strips	14100
Tyvek® Pouches and Rolls with STERRAD® Chemical Indicator	Visit <a href="http://www.sterrad.com">www.sterrad.com</a> for a complete list of pouches, rolls, instrument trays and accessories
APTIMAX® Instrument Trays and accessories	
STERRAD® Instrument Trays and accessories	

ASP also offers a full line of other consumables and accessories which have been fully tested and validated for use with the STERRAD® NX Sterilizer. For more information on any of these products, in the U.S.A. contact the ASP Customer Care Center at 1-888-STERRAD. Internationally, contact your local ASP Customer Support Representative.

Tyvek® is a registered trademark of E.I. du Pont de Nemours and Company.

## Appendix C.

**STERRAD<sup>®</sup> NX<sup>™</sup>**  
**Sterilizer Specifications**

Power	Single phase, offered in two voltage ranges: 99-132 VAC~, 47-63 Hz, 16A 180-264 VAC~, 47-63 Hz, 10A
Dimensions	H 33 in. (84 cm), W 22 in. (56 cm), D 32 in. (81 cm). Footprint: fits onto 23 in. (58.5 cm) deep countertop.
Service clearances	Front 39 in. (100 cm), Rear 1 in. (25 mm), Top 24 in. (61 cm). Left side 2.4 in. (6 cm), Right side 24 in. (61 cm).
Weight	275 lb. (125 kg).
Chamber volume	30 liters. H 6.2 in. (15.7 cm), W 12.6 in. (32 cm), D 23.6 in. (60 cm).
Chamber shelves	Two shelves, W 12.3 in. (31.2 cm), D 23.6 in. (60 cm). Shelf capacity: 25 lb. (11.4 kg) uniformly distributed. Top shelf is removable.
Temperature	Operating: 18 °C – 35 °C (64 °F – 95 °F). Storage: -40 °C to +70 °C (-40 °F to +158 °F).

Humidity	Operating: 10% – 85% up to 30 °C, linearly decreasing from 85% at 30 °C to 70% at 40 °C. Storage: 10% – 100% (rainfall will be permitted).
Altitude/Pressure	Operating altitude up to 3048 m (10,000 ft). Atmospheric pressure 70 kPa – 106 kPa (700 mbar – 1060 mbar), (20.7 in. Hg – 31.3 in. Hg).
Cycle temperature	46 °C – 55 °C (115 °F – 131 °F)
Cycle time	Standard cycle: approx. 30 min. Advanced cycle: approx 40 min.
Cycles per cassette	5
Connectors	Network: RJ45; Barcode reader: USB.
Data storage	PCMCIA nonstandard compact flash.
Cordset and plug	12 AWG, 98 cm (38.6 inches) long. NEMA 5-20P, IEC-320-C19.
RF Generation	Portable and mobile RF communications equipment can affect medical Electrical Equipment.