



USER GUIDE

Manufacturer

FUJIFILM SonoSite, Inc.
21919 30th Drive SE
Bothell, WA 98021 USA
T: 1-888-482-9449 or 1-425-951-1200
F: 1-425-951-1201

EC Authorized Representative

FUJIFILM SonoSite B.V.
Joop Geesinkweg 140
1114 AB Amsterdam,
The Netherlands

Australia Sponsor

FUJIFILM SonoSite Australasia Pty Ltd
114 Old Pittwater Road
BROOKVALE, NSW, 2100
Australia

Caution

Federal (United States) law restricts this device to sale by or on the order of a physician.

SonoMB, SonoSite Synchronicity, SonoSite, Steep Needle Profiling, X-Porte, and the SonoSite logo are registered and unregistered trademarks of FUJIFILM SonoSite, Inc. in various jurisdictions. FUJIFILM is a registered trademark of FUJIFILM Corporation. Value from Innovation is a trademark of FUJIFILM Holdings America Corporation.

DICOM is a registered trademark of the National Electrical Manufacturers Association.

All other trademarks are the property of their respective owners.

Patents: US 9,895,133; US 9,848,851; US 9,671,491; US 9,420,998; US 9,151,832; US 8,876,719; US 8,861,822; US D712,540; US D712,539; US D712,038; US D712,037; US 8,568,319; US 8,500,647; US 8,398,408; US 8,213,467; US 8,088,071; US 8,066,642; US D625,015; US D625,014; US 7,740,586; US 7,591,786; US 7,588,541; US 6,471,651; US 6,364,839; CA 2,372,152; CA 2,371,711; CN ZL201180028132.X; CN ZL2010800609363; EP 2498683 validated in DE and FR; EP 1589878 validated in DE, FR, and GB; EP 1552792 validated in DE, FR, and GB; EP 1180971 validated in DE and GB; EP 1180970 validated in DE, FR, and GB; JP 6258367; JP 6227724; JP 5973349; JP 5972258.

Part Number: P14645-07

Publication Date: June 2019

Copyright © 2019 FUJIFILM SonoSite, Inc. All Rights reserved.



CONTENTS

1. Introduction

About the SonoSite X-Porte User Guide	1-1
Changes in this version	1-2
Document conventions	1-2
Getting help	1-3

2. Getting started

About the system	2-1
Intended use	2-2
Indications for use	2-2
Contraindications	2-14
Hardware features	2-15
Accessories and peripherals	2-16
Preparing the system	2-16
Turning on the system	2-16
Adjusting the height and angle	2-17
USB devices	2-18
General interaction	2-19
Clinical monitor	2-19
VGA or digital video output	2-21
Touch panel	2-21
Onscreen keyboard	2-23
Preparing transducers	2-24
Connecting transducers	2-24
Selecting a transducer and exam type	2-27
Gel	2-32
Sheaths	2-33
Ports	2-33
Battery charge indicator	2-35
Transporting the system	2-35
Visual Guide videos	2-37

3. Setting up the system

Administration settings	3-1
About security settings	3-2
Managing the Administrator account	3-2

Protecting patient information	3-3
Adding and managing user accounts	3-3
Configuring Auto Delete	3-5
Logging in	3-6
Audio settings	3-6
Calculations settings	3-7
Cardiac calculations settings	3-7
Obstetrics calculations settings	3-7
CDA Report settings	3-11
Connectivity settings	3-12
Importing and exporting connectivity settings	3-13
DICOM	3-14
Configuring the system for DICOM transfer	3-15
Connecting to the network	3-15
DICOM configuration pages	3-17
Associating devices with locations	3-26
Date and Time settings	3-27
Display Information settings	3-28
Logs	3-28
Network Status settings	3-30
Power and Battery settings	3-30
Presets settings	3-31
General preferences	3-31
Brightness	3-32
Labels	3-32
Exam types	3-33
User profile settings	3-34
Importing and exporting	3-36
Routing selections	3-36
Associating routing selections with exams	3-37
Specifying educational DICOM archivers	3-38
System Information settings	3-38
USB settings	3-39
Limitations of JPEG format	3-40

4. Imaging

Imaging modes	4-1
2D	4-2
M Mode	4-2
Color	4-3
Doppler	4-4
Dual	4-5
Simultaneous Doppler	4-7
Imaging controls	4-8
Controls in 2D	4-9
Controls in M Mode	4-14

Controls in Color	4-16
Controls in Doppler	4-18
Adjusting depth and gain	4-22
Depth	4-22
Gain	4-23
Freezing, viewing frames, and zooming	4-24
Freezing the image	4-24
Viewing the cine buffer	4-24
Zooming in on the image	4-25
Visualizing needles	4-26
Needle size and angle	4-29
Additional recommendations	4-29
Labeling images	4-30
Adding text labels	4-30
Adding arrows	4-31
Adding pictographs	4-31
Setting the home position	4-32
Labeling during review	4-32
Entering patient information	4-33
Editing patient information	4-33
Entering patient information manually	4-34
Entering patient information from the worklist	4-34
Ending the exam	4-37
Patient form fields	4-37
Images and clips	4-40
Reviewing	4-40
Printing images	4-43
Archiving and exporting	4-44
Saving images and video clips	4-47
DVR recording	4-49
Image Gallery	4-51
ECG	4-52

5. Measurements and calculations

Measuring	5-1
Calipers	5-1
Viewing and deleting measurement results	5-2
Basic measurements in 2D	5-2
Basic measurements in M Mode	5-3
Basic measurements in Doppler	5-4
Assigning measurements to calculations	5-8
About calculations	5-8
Overview	5-9
Percent reduction calculations	5-11
Volume calculation	5-12
Volume flow calculation	5-12

Exam-based calculations	5-13
Abdominal calculations	5-13
Arterial calculations	5-14
Cardiac calculations	5-18
Gynecological calculations	5-34
Obstetrics calculations	5-37
Small Parts and MSK calculations	5-43
Acute Care calculations	5-44
Transcranial Doppler and Orbital calculations	5-47
Worksheets and reports	5-50
Report preview	5-51
Acute Care and MSK worksheets	5-53
Printing reports and worksheets	5-54
Displaying reports after the exam has ended	5-54
Customizing worksheets	5-55
Remote worksheets	5-55
Measuring during review	5-57

6. Measurement references

Measurement accuracy	6-1
Sources of measurement errors	6-3
Measurement publications and terminology	6-3
Cardiac references	6-4
Obstetrical references	6-15
General references	6-21

7. Troubleshooting and maintenance

Troubleshooting	7-1
Software licensing	7-3
Maintenance	7-5
System backups	7-5
Servicing	7-6

8. Cleaning and disinfecting

Before getting started	8-1
Determining the required cleaning and disinfecting level	8-2
Spaulding classifications	8-2
Clean and disinfect system and transducer to a high-level (semi-critical uses)	8-3
Clean and disinfect system and transducer to a low-level (non-critical uses).....	8-8
Storing the transducer	8-11
Transporting the transducer	8-11
Accessories.....	8-13

Cleaning and disinfecting accessories	8-13
Cleaning and disinfecting the stand or Triple Transducer Connect (TTC)	8-14
Cleaning the footswitch	8-14
Cleaning and disinfecting the ECG cable and slave cable	8-15

9. Safety

Ergonomic safety	9-1
Position the system	9-2
Position yourself	9-2
Take breaks, exercise, and vary activities	9-3
Electrical safety	9-3
Electrical safety classification	9-5
Isolating the SonoSite X-Porte ultrasound system from power	9-6
Equipment safety	9-7
Clinical Safety	9-8
Electromagnetic compatibility	9-10
Wireless transmission	9-12
Electrostatic discharge	9-13
Separation distance	9-14
Compatible accessories and peripherals	9-15
Manufacturer's declaration	9-18
Labeling symbols	9-24
Specifications	9-33
Dimensions	9-33
Environmental limits	9-34
Electrical	9-34
Imaging modes	9-34
Image and video clip storage capacity	9-34
Standards	9-35
Electromechanical safety standards	9-35
EMC standards classification	9-36
DICOM standard	9-36
HIPAA standard	9-36

10. Acoustic output

ALARA principle	10-1
Applying the ALARA principle	10-1
Direct, indirect, and receiver controls	10-2
Acoustic artifacts	10-3
Guidelines for reducing MI and TI	10-3
Output display	10-5
MI and TI output display accuracy	10-7
Factors that contribute to display uncertainty	10-7
Related guidance documents	10-8

Transducer surface temperature rise	10-8
Acoustic output measurement	10-9
Tissue models and equipment survey	10-10
Acoustic output tables	10-11
Acoustic measurement precision and uncertainty	10-89
Terminology in acoustic output tables	10-90

11. IT Network

Functions	11-1
Network for connecting the device	11-1
Specifications for the connection	11-1
Hardware specification	11-1
Security	11-1
Data flow	11-2
IT network failure recovery measures	11-3

A. Glossary

Terms	A-1
Abbreviations	A-2

B. Index

CHAPTER 1

Introduction

About the SonoSite X-Porte User Guide

The *SonoSite X-Porte User Guide* provides information on preparing and using the SonoSite X-Porte ultrasound system and on cleaning and disinfecting the system and transducers. It also provides system specification, and safety and acoustic output information.

Note

We highly recommend you read the entire user guide before using the system.

The user guide is intended for a user familiar with ultrasound. It does not provide training in sonography, ultrasound, and clinical practices. Before using the SonoSite X-Porte ultrasound system, you must complete such training.

Refer to the applicable FUJIFILM SonoSite accessory user guide for information on using accessories and peripherals. Refer to the manufacturer's instructions for specific information about peripherals.

Changes in this version

Change	Description
Intended use	Updated the Intended use section to comply with regulatory requirements.
Auto-delete feature	Added the new auto-delete setting under Administration settings
Measurement references	Added new references to the Measurements and calculations and the Measurement references chapter.
EMC standards and symbols glossary	Updated the electromagnetic standards and symbols table in the Safety chapter.
Acoustic output tables	Updated the format and terminology of the acoustic output tables in the Acoustic output chapter to comply with new standards.
Incorporated user guide supplements and erratas	<ul style="list-style-type: none">▶ P21471-03▶ P23266-01▶ P23130-02▶ P19437-02

Document conventions

The document follows these conventions:

- ▶ A **WARNING** describes precautions necessary to prevent injury or loss of life.
- ▶ A **Caution** describes precautions necessary to protect the products.
- ▶ A **Note** provides supplemental information.
- ▶ Numbered and lettered steps must be performed in a specific order.
- ▶ Bulleted lists present information in list format but do not imply a sequence.
- ▶ Single-step procedures begin with ❖.

Symbols and terms used on the system and transducer are explained in “**Labeling symbols**” on page 9-24 and the “**Glossary**” on page A-1.

Getting help

In addition to the *SonoSite X-Porte User Guide*, the following are available:

- ▶ Visual Guide videos. See “**Visual Guide videos**” on page 2-37.
- ▶ On-system Help: tap **MORE**, and then tap **Help**.
- ▶ *SonoSite X-Porte Getting Started Guide*.
- ▶ Service manual.
- ▶ FUJIFILM SonoSite Technical Support

Phone (U.S. or Canada)	(877) 657-8118
Phone (Outside U.S. or Canada)	(425) 951-1330, or call your local representative
Fax	(425) 951-6700
E-mail	ffss-service@fujifilm.com
Web	www.sonosite.com
Europe Service Center	Main: +31 20 751 2020 English support: +44 14 6234 1151 French support: +33 1 8288 0702 German support: +49 69 8088 4030 Italian support: +39 02 9475 3655 Spanish support: +34 91 123 8451
Asia Service Center	+65 6380-5589

CHAPTER 2

Getting started

WARNING | Do not use the system if it exhibits erratic or inconsistent behavior. Such behavior could indicate a hardware failure. Contact FUJIFILM SonoSite Technical Support.

About the system

The SonoSite X-Porte is a portable device that acquires and displays high-resolution, real-time ultrasound images. Features available depend on your system configuration, transducer, and exam type.

Intended use

The intended use is: Medical Diagnostic Ultrasound. The SonoSite X-Porte ultrasound system is intended for diagnostic ultrasound imaging or fluid flow analysis of the human body.

Indications for use

Diagnostic ultrasound

The SonoSite X-Porte ultrasound system is a general purpose ultrasound system and non-continuous patient monitoring platform intended for use in clinical care by qualified physicians and healthcare professionals for evaluation by ultrasound imaging or fluid flow analysis. Clinical indications include:

- ▶ Fetal
- ▶ Transvaginal
- ▶ Abdominal
- ▶ Pediatric
- ▶ Small organ (breast, thyroid, testicles, prostate)
- ▶ Musculoskeletal (conventional)
- ▶ Musculoskeletal (superficial)
- ▶ Cardiac adult
- ▶ Cardiac pediatric
- ▶ Transesophageal (cardiac)
- ▶ Peripheral vessel
- ▶ Ophthalmic
- ▶ Adult cephalic
- ▶ Neonatal cephalic

The system is used with a transducer attached and is powered either by battery or by AC electrical power. The clinician is positioned beside the patient and places the transducer onto the patient's body where needed to obtain the desired ultrasound image.

Indications for use table

The following table displays the indications for use and imaging modes for each transducer. The exam types available on the system are displayed in [Table 2-3](#) on page 2-28.

Table 2-1: Diagnostic ultrasound indications for use

Transducer	Clinical application	Imaging mode ^a						
		B	M	C	PWD	CWD	Combined (specify)	Other
D2xp	Cardiac adult	—	—	—	—	✓	—	b, c
	Cardiac pediatric	—	—	—	—	✓	—	b, c
C11xp	Abdominal	✓	✓	✓	✓	—	B+M; B+PWD; B+C; (B+C)+PWD	b, c
	Cardiac pediatric	✓	✓	✓	✓	—	B+M; B+PWD; B+C; (B+C)+PWD	b, c
	Neonatal cephalic	✓	✓	✓	✓	—	B+M; B+PWD; B+C; (B+C)+PWD	b, c
	Pediatric	✓	✓	✓	✓	—	B+M; B+PWD; B+C; (B+C)+PWD	b, c
	Peripheral vessel	✓	✓	✓	✓	—	B+M; B+PWD; B+C; (B+C)+PWD	b, c
C35xp	Abdominal	✓	✓	✓	✓	—	B+M; B+PWD; B+C; (B+C)+PWD	b, c, d
	Musculoskeletal (conventional)	✓	✓	✓	✓	—	B+M; B+PWD; B+C; (B+C)+PWD	b, c, d, e
	Pediatric	✓	✓	✓	✓	—	B+M; B+PWD; B+C; (B+C)+PWD	b, c, d, e
	Peripheral vessel	✓	✓	✓	✓	—	B+M; B+PWD; B+C; (B+C)+PWD	b, c, d, e

Table 2-1: Diagnostic ultrasound indications for use (continued)

Transducer	Clinical application	Imaging mode ^a						
		B	M	C	PWD	CWD	Combined (specify)	Other
C60xp	Abdominal	✓	✓	✓	✓	—	B+M; B+PWD; B+C; (B+C)+PWD	b, c, d
	Fetal	✓	✓	✓	✓	—	B+M; B+PWD; B+C; (B+C)+PWD	b, c, d
	Musculoskeletal (conventional)	✓	✓	✓	✓	—	B+M; B+PWD; B+C; (B+C)+PWD	b, c, d, e
	Pediatric	✓	✓	✓	✓	—	B+M; B+PWD; B+C; (B+C)+PWD	b, c, d, e
	Peripheral vessel	✓	✓	✓	✓	—	B+M; B+PWD; B+C; (B+C)+PWD	b, c, d, e
HFL38xp	Abdominal	✓	✓	✓	✓	—	B+M; B+PWD; B+C; (B+C)+PWD	b, c, e
	Cardiac adult	✓	✓	✓	✓	—	B+M; B+PWD; B+C; (B+C)+PWD	b, c
	Cardiac pediatric	✓	✓	✓	✓	—	B+M; B+PWD; B+C; (B+C)+PWD	b, c
	Musculoskeletal (conventional)	✓	✓	✓	✓	—	B+M; B+PWD; B+C; (B+C)+PWD	b, c, e
	Musculoskeletal (superficial)	✓	✓	✓	✓	—	B+M; B+PWD; B+C; (B+C)+PWD	b, c, e
	Pediatric	✓	✓	✓	✓	—	B+M; B+PWD; B+C; (B+C)+PWD	b, c, e
	Peripheral vessel	✓	✓	✓	✓	—	B+M; B+PWD; B+C; (B+C)+PWD	b, c, e, f
	Small organ	✓	✓	✓	✓	—	B+M; B+PWD; B+C; (B+C)+PWD	b, c, e

Table 2-1: Diagnostic ultrasound indications for use (continued)

Transducer	Clinical application	Imaging mode ^a						
		B	M	C	PWD	CWD	Combined (specify)	Other
HFL50xp	Abdominal	✓	✓	✓	✓	—	B+M; B+PWD; B+C; (B+C)+PWD	b, c, e
	Musculoskeletal (conventional)	✓	✓	✓	✓	—	B+M; B+PWD; B+C; (B+C)+PWD	b, c, e
	Musculoskeletal (superficial)	✓	✓	✓	✓	—	B+M; B+PWD; B+C; (B+C)+PWD	b, c, e
	Pediatric	✓	✓	✓	✓	—	B+M; B+PWD; B+C; (B+C)+PWD	b, c, e
	Peripheral vessel	✓	✓	✓	✓	—	B+M; B+PWD; B+C; (B+C)+PWD	b, c, e
	Small organ	✓	✓	✓	✓	—	B+M; B+PWD; B+C; (B+C)+PWD	b, c, e

Table 2-1: Diagnostic ultrasound indications for use (continued)

Transducer	Clinical application	Imaging mode ^a						
		B	M	C	PWD	CWD	Combined (specify)	Other
HSL25xp	Abdominal	✓	✓	✓	✓	—	B+M; B+PWD; B+C; (B+C)+PWD	b, c, e
	Cardiac adult	✓	✓	✓	✓	—	B+M; B+PWD; B+C; (B+C)+PWD	b, c
	Cardiac pediatric	✓	✓	✓	✓	—	B+M; B+PWD; B+C; (B+C)+PWD	b, c
	Musculoskeletal (conventional)	✓	✓	✓	✓	—	B+M; B+PWD; B+C; (B+C)+PWD	b, c, e
	Musculoskeletal (superficial)	✓	✓	✓	✓	—	B+M; B+PWD; B+C; (B+C)+PWD	b, c, e
	Ophthalmic	✓	✓	✓	✓	—	B+M; B+PWD; B+C; (B+C)+PWD	b, c, e
	Pediatric	✓	✓	✓	✓	—	B+M; B+PWD; B+C; (B+C)+PWD	b, c, e
	Peripheral vessel	✓	✓	✓	✓	—	B+M; B+PWD; B+C; (B+C)+PWD	b, c, e, f
	Small organ	✓	✓	✓	✓	—	B+M; B+PWD; B+C	b, c, e
ICTxp	Fetal	✓	✓	✓	✓	—	B+M; B+PWD; B+C; (B+C)+PWD	b, c
	Transvaginal	✓	✓	✓	✓	—	B+M; B+PWD; B+C; (B+C)+PWD	b, c

Table 2-1: Diagnostic ultrasound indications for use (continued)

Transducer	Clinical application	Imaging mode ^a						
		B	M	C	PWD	CWD	Combined (specify)	Other
L25xp	Abdominal	✓	✓	✓	✓	—	B+M; B+PWD; B+C; (B+C)+PWD	b, c, e
	Cardiac adult	✓	✓	✓	✓	—	B+M; B+PWD; B+C; (B+C)+PWD	b, c
	Cardiac pediatric	✓	✓	✓	✓	—	B+M; B+PWD; B+C; (B+C)+PWD	b, c
	Musculoskeletal (conventional)	✓	✓	✓	✓	—	B+M; B+PWD; B+C; (B+C)+PWD	b, c, e
	Musculoskeletal (superficial)	✓	✓	✓	✓	—	B+M; B+PWD; B+C; (B+C)+PWD	b, c, e
	Ophthalmic	✓	✓	✓	✓	—	B+M; B+PWD; B+C; (B+C)+PWD	b, c
	Pediatric	✓	✓	✓	✓	—	B+M; B+PWD; B+C; (B+C)+PWD	b, c, e
	Peripheral vessel	✓	✓	✓	✓	—	B+M; B+PWD; B+C; (B+C)+PWD	b, c, e, f
	Small organ	✓	✓	✓	✓	—	B+M; B+PWD; B+C; (B+C)+PWD	b, c, e

Table 2-1: Diagnostic ultrasound indications for use (continued)

Transducer	Clinical application	Imaging mode ^a						
		B	M	C	PWD	CWD	Combined (specify)	Other
L38xp	Abdominal	✓	✓	✓	✓	—	B+M; B+PWD; B+C; (B+C)+PWD	b, c, e
	Cardiac adult	✓	✓	✓	✓	—	B+M; B+PWD; B+C; (B+C)+PWD	b, c
	Cardiac pediatric	✓	✓	✓	✓	—	B+M; B+PWD; B+C; (B+C)+PWD	b, c
	Musculoskeletal (conventional)	✓	✓	✓	✓	—	B+M; B+PWD; B+C; (B+C)+PWD	b, c, e
	Musculoskeletal (superficial)	✓	✓	✓	✓	—	B+M; B+PWD; B+C; (B+C)+PWD	b, c, e
	Pediatric	✓	✓	✓	✓	—	B+M; B+PWD; B+C; (B+C)+PWD	b, c, e
	Peripheral vessel	✓	✓	✓	✓	—	B+M; B+PWD; B+C; (B+C)+PWD	b, c, e, f
	Small organ	✓	✓	✓	✓	—	B+M; B+PWD; B+C; (B+C)+PWD	b, c, e

Table 2-1: Diagnostic ultrasound indications for use (continued)

Transducer	Clinical application	Imaging mode ^a						
		B	M	C	PWD	CWD	Combined (specify)	Other
P10xp	Abdominal	✓	✓	✓	✓	—	B+M; B+PWD; B+C; (B+C)+PWD	b
	Fetal	✓	✓	✓	✓	—	B+M; B+PWD; B+C; (B+C)+PWD	b
	Cardiac adult	✓	✓	✓	✓	✓	B+M; B+PWD; B+C; (B+C)+PWD	b, g
	Cardiac pediatric	✓	✓	✓	✓	✓	B+M; B+PWD; B+C; (B+C)+PWD	b
	Musculoskeletal (conventional)	✓	✓	✓	✓	—	B+M; B+PWD; B+C; (B+C)+PWD	b
	Neonatal cephalic	✓	✓	✓	✓	—	B+M; B+PWD; B+C; (B+C)+PWD	b
	Pediatric	✓	✓	✓	✓	—	B+M; B+PWD; B+C; (B+C)+PWD	b
	Peripheral vessel	✓	✓	✓	✓	—	B+M; B+PWD; B+C; (B+C)+PWD	b
	Small organ	✓	✓	✓	✓	—	B+M; B+PWD; B+C; (B+C)+PWD	b

Table 2-1: Diagnostic ultrasound indications for use (continued)

Transducer	Clinical application	Imaging mode ^a						
		B	M	C	PWD	CWD	Combined (specify)	Other
rP19xp	Abdominal	✓	✓	✓	✓	—	B+M; B+PWD; B+CWD; B+C; (B+C)+PWD; (B+C)+PWD	b, d
	Adult cephalic	✓	✓	✓	✓	—	B+M; B+PWD; B+C; (B+C)+PWD	b
	Cardiac adult	✓	✓	✓	✓	✓	B+M; B+PWD; B+CWD; B+C; (B+C)+PWD; (B+C)+PWD	b, d, g
	Cardiac pediatric	✓	✓	✓	✓	✓	B+M; B+PWD; B+CWD; B+C; (B+C)+PWD; (B+C)+PWD	b, d, g
	Fetal	✓	✓	✓	✓	—	B+M; B+PWD; B+C; (B+C)+PWD	b, d, g
	Musculoskeletal (conventional)	✓	✓	✓	✓	—	B+M; B+PWD; B+C; (B+C)+PWD	b, d
	Neonatal cephalic	✓	✓	✓	✓	—	B+M; B+PWD; B+C; (B+C)+PWD	b
	Pediatric	✓	✓	✓	✓	—	B+M; B+PWD; B+C; (B+C)+PWD	b, d, g
	Peripheral vessel	✓	✓	✓	✓	—	B+M; B+PWD; B+C; (B+C)+PWD	b, d
	Small organ	✓	✓	✓	✓	—	B+M; B+PWD; B+C; (B+C)+PWD	b, d, g

Table 2-1: Diagnostic ultrasound indications for use (continued)

Transducer	Clinical application	Imaging mode ^a						
		B	M	C	PWD	CWD	Combined (specify)	Other
P21xp	Abdominal	✓	✓	✓	✓	—	B+M; B+PWD; B+CWD; B+C; (B+C)+PWD; (B+C)+PWD	b, d, g
	Adult cephalic	✓	✓	✓	✓	—	B+M; B+PWD; B+C; (B+C)+PWD	b, d, g
	Cardiac adult	✓	✓	✓	✓	✓	B+M; B+PWD; B+CWD; B+C; (B+C)+PWD; (B+C)+PWD	b, d, g
	Cardiac pediatric	✓	✓	✓	✓	✓	B+M; B+PWD; B+CWD; B+C; (B+C)+PWD; (B+C)+PWD	b, d, g
	Fetal	✓	✓	✓	✓	—	B+M; B+PWD; B+C; (B+C)+PWD	b, d, g
	Musculoskeletal (conventional)	✓	✓	✓	✓	—	B+M; B+PWD; B+C; (B+C)+PWD	b, d, g
	Neonatal cephalic	✓	✓	✓	✓	—	B+M; B+PWD; B+C; (B+C)+PWD	b, d, g
	Pediatric	✓	✓	✓	✓	—	B+M; B+PWD; B+C; B+CWD	b, d, g
	Peripheral vessel	✓	✓	✓	✓	—	B+M; B+PWD; B+C; (B+C)+PWD	b, d, g
	Small organ	✓	✓	✓	✓	—	B+M; B+PWD; B+C; (B+C)+PWD	b, d, g
TEExp	Transesophageal (cardiac)	✓	✓	✓	✓	✓	B+M; B+PWD; B+CWD; B+C; (B+C)+PWD; (B+C)+PWD	b, g

Table 2-1: Diagnostic ultrasound indications for use (continued)

Transducer	Clinical application	Imaging mode ^a						
		B	M	C	PWD	CWD	Combined (specify)	Other
^a B or 2D = B-Mode; M = M-Mode; PWD = Pulse Wave Doppler; CWD = Continuous Wave Doppler; C = Color Doppler (Velocity Color Doppler, Color Power Doppler, or Variance) ^b Needle guide-capable (assists in the placement of needles and catheters in vascular or other anatomical structures and imaging guidance for peripheral nerve block procedures) ^c Multi-beam imaging (SonoMB) in B-Mode ^d Tissue Harmonic Imaging (THI) ^e Steep Needle Profiling (SNP) = Needle enhancement in B-Mode ^f B+PWD and (B+C)+PWD includes Simultaneous PW ^g Tissue Doppler Imaging (TDI)								

The system transmits ultrasound energy into the patient's body to obtain ultrasound images as listed in the following sections.

Abdominal imaging applications

You can assess the liver, kidneys, pancreas, spleen, gallbladder, bile ducts, transplanted organs, abdominal vessels, and surrounding anatomical structures for the presence or absence of pathology transabdominally. You can evaluate and perform interventional abdominal procedures and evaluate blood flow in abdominal organs.

Arterial and venous imaging applications

You can assess the carotid arteries, deep veins and arteries in the arms and legs, superficial veins in the arms and legs, great vessels in the abdomen, and various small vessels feeding organs for the presence or absence of pathology.

Cardiac imaging applications

You can assess the cardiac valves, the great vessels, heart size, cardiac function, hemodynamic assessment, and surrounding anatomical structures for the presence or absence of pathology.

You can use the licensed FUJIFILM SonoSite ECG function to display the patient's heart rate and provide a cardiac cycle reference when viewing an ultrasound image.

WARNING

Do not use the SonoSite ECG to diagnose cardiac arrhythmia or to provide long-term cardiac monitoring.

Gynecology and infertility imaging applications

You can assess the uterus, ovaries, adnexa, and surrounding anatomical structures for the presence or absence of pathology transabdominally or transvaginally. You can assess blood flow in pelvic organs transabdominally and transvaginally.

Interventional department imaging applications

You can use the system for ultrasound guidance in biopsy and drainage procedures, vascular line placement, peripheral nerve blocks, amniocentesis, and other obstetrical procedures.

Obstetrical imaging applications

WARNING

During the first trimester, you should limit the duration of ultrasound imaging based on MI/TI. See [Chapter 10, “Acoustic output,”](#) for more information.

You can assess the fetal anatomy, viability, estimated fetal weight, fetal heart rate, fetal position, gestational age, amniotic fluid, and surrounding anatomical structures for the presence or absence of pathology transabdominally or transvaginally.

You can evaluate the blood flow of the fetus, placenta, umbilical cord, and surrounding maternal structures.

Color Power Doppler (CPD) and Color Velocity Doppler (CVD) imaging tools are intended to evaluate the blood flow of the fetus, placenta, umbilical cord, and surrounding maternal structures in all cases, including high-risk pregnancies. High-risk pregnancy indications include, but are not limited to, multiple pregnancies, fetal hydrops, placental abnormalities, maternal hypertension, diabetes, and lupus. CPD and Color imaging tools are not intended as a sole means of diagnosis nor as a sole method of high-risk pregnancy screening.

WARNINGS

- ▶ CPD or Color images can be used as an adjunctive method, not as a screening tool, for the detection of structural anomalies of the fetal heart and as an adjunctive method, not as a screening tool, for the diagnosis of Intrauterine Growth Retardation (IUGR).
- ▶ To prevent injury or misdiagnosis, do not use this system for Percutaneous Umbilical Blood Sampling (PUBS) or *in vitro* Fertilization (IVF). The system has not been validated to be proven effective for these two uses.

Pediatric and neonatal imaging applications

You can assess the neonatal abdominal, pelvic and cardiac anatomy, neonatal head, and surrounding anatomical structures for the presence or absence of pathology.

Transcranial imaging applications

You can assess the anatomical structures and vascular anatomy of the brain for the presence or absence of pathology. You can use imaging temporally, transoccipitally, or transorbitally.

WARNING

To avoid injury to the patient, use only an Orbital (Orb) or Ophthalmic (Oph) exam type when performing imaging through the eye. The FDA has established lower acoustic energy limits for ophthalmic use. The system will not exceed these limits only if the Orb or Oph exam type is selected.

Small parts, breast, musculoskeletal, nerve, superficial, and lung imaging applications

You can assess the breast, thyroid, testicle, lymph nodes, hernias, musculoskeletal structures, soft tissue structures, ophthalmic structures, and surrounding anatomical structures for the presence or absence of pathology. You can detect normal lung motion for the presence or absence of pathology. You can demonstrate blood flow in superficial anatomical structures.

You can use the system for ultrasound guidance in biopsy and drainage procedures, vascular line placement, and peripheral nerve blocks.

Contraindications

The SonoSite X-Porte ultrasound system has no known contraindications.

Hardware features

Figure 2-1 and **Figure 2-2** display the SonoSite X-Porte in kiosk mode. The ultrasound core can be detached from the kiosk to provide a desktop configuration.

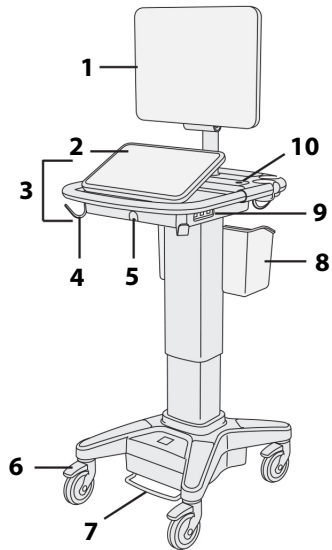

Figure 2-1 SonoSite X-Porte front view

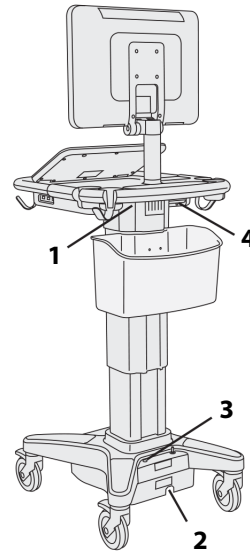

Figure 2-2 SonoSite X-Porte rear view

1. Clinical monitor, 2. Touch panel, 3. Platform,
4. Hook (4), 5. Transducer connector, 6. Locking
wheel (4), 7. Height-adjustment pedal,
8. Basket, 9. USB ports (3), 10. Power button

1. Ports on dock, 2. Power cord
connector, 3. Battery charge
indicator, 4. Ports on dock

A license key is required to activate the software. See **“Software licensing”** on page 7-3.

Basic operating steps

- 1 Connect a transducer. See **“Connecting transducers”** on page 2-24.
- 2 Turn on the system. See **“Turning on the system”** on page 2-16.
- 3 Select the transducer and exam type (or use the default selections). See **“Selecting a transducer and exam type”** on page 2-27.
- 4 (Optional) Enter patient information. See **“Entering patient information”** on page 4-33.

5 Scan. See “[Imaging modes](#)” on page 4-1.

Accessories and peripherals

The system supports various accessories and peripherals. See “[Compatible accessories and peripherals](#)” on page 9-15.

Preparing the system

Turning on the system

WARNINGS

- ▶ Verify that the hospital supply voltage corresponds to the power supply voltage range.
- ▶ Plug the system only into a grounded hospital-grade outlet.
- ▶ Use only power cords provided by FUJIFILM SonoSite with the system.

Cautions

- ▶ Do not use the system if an error message appears on the clinical monitor. Note the error code and turn off the system. Call FUJIFILM SonoSite or your local representative.
- ▶ When using AC power, position the system to allow easy access to disconnect it.

To turn on the system

The system can be powered by the internal battery or by AC power.

- 1 If you are operating the system using AC power, connect the AC power cord to the stand, and then connect the AC power cord to a hospital-grade outlet.
- 2 Press the power button.

The power button turns green when the system is ready for scanning.

If the system does not maintain expected battery charge, or if the battery icon on the clinical monitor does not display the battery charge status, disconnect and reconnect the system to AC power.

Connect the system to AC power to maintain battery charge, especially if the system will not be used for several days.

To connect the system to AC power (battery charge maintenance)

- 1 Turn off the system.
- 2 Disconnect the system from AC power.

- 3 Check the battery switches; ensure that all three switches are depressed to the **⓪** symbol, which is the ON position.

Note

The system will not charge and maintain the batteries if the battery switches are depressed to the **⓪** symbol, which is the OFF position.

- 4 Reconnect the system to AC power.

The battery charge indicator at the base of the stand blinks green, and the battery icon on the clinical monitor displays the battery charging state.

To turn off the system

Note

If the system appears unresponsive, wait several minutes before restarting it. Restarting the system while it is performing data-intensive background activities, such as transferring patient files, can result in loss of patient data. To power down an unresponsive system, press and hold the power button until the system shuts down. This procedure may take 5 seconds or longer.

- ❖ Press the power button.

The system will power down when your data is safe. Any in-progress transfers will complete when power is restored.

Adjusting the height and angle

WARNINGS

- ▶ Lock the wheels whenever the system is unattended or stationary.
- ▶ To avoid possible injury from an unexpected clinical monitor collapse during system transport, collapse the clinical monitor before system transport (see **“To collapse the clinical monitor”** on page 2-18).

To raise or lower the platform

- ❖ While pressing down the height-adjustment pedal, grasp both sides of the platform and push down or pull up to the desired height.

To lock a wheel

- ❖ Press down the lever on the wheel.

To unlock the wheel, press up on the bottom of the lever.

To adjust the clinical monitor angle

- ❖ Grasping the clinical monitor on both sides, tilt or rotate it.

To adjust the touch-panel angle

- ❖ Grasping the sides of the touch panel, pull it forward or push it backward to the desired angle.

To collapse the clinical monitor

Always collapse the clinical monitor before system transport.

- 1 Adjust the touch panel angle to the lowest position.
- 2 Grasping the clinical monitor on both sides, align it squarely above the touch panel.
- 3 Fold the clinical monitor downward over the touch panel. Refer to [Figure 2-3](#) on page 2-18.

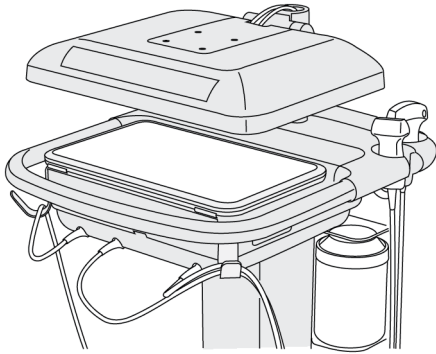

Figure 2-3 Clinical monitor collapsed for system transport

USB devices

You can use the USB ports on the system for connecting devices such as a USB printer or a USB memory stick. For a list of supported devices, see [“Compatible accessories and peripherals”](#) on page 9-15.

One of the USB ports at the back of the system is for DVR recording only. See [“Ports”](#) on page 2-33 and [“DVR recording”](#) on page 4-49.

USB memory sticks

You can use a USB memory stick to export patient exams, import and export logs and setup configurations, and to import custom obstetric calculation tables.

Note

The system does not support software-encrypted USB memory sticks.

Cautions

- ▶ To avoid damaging the USB memory stick and losing patient data from it, observe the following:
 - ▶ Do not remove the USB memory stick or turn off the ultrasound system while the system is exporting.
 - ▶ Do not bump or otherwise apply pressure to the USB memory stick while it is in a USB port on the ultrasound system. The connector could break.
- ▶ If the USB icon  does not appear in the system status area on the clinical monitor, the USB memory stick may be defective or software-encrypted. Replace the USB memory stick.

To connect a USB memory stick for importing or exporting

- ❖ Insert the USB memory stick into a USB port (see [“About the system”](#) on page 2-1).

The USB memory stick is ready when the USB icon  appears onscreen.

To view information about the device, see [“USB settings”](#) on page 3-39.

To disconnect a USB memory stick

Disconnecting the USB memory stick while the system is exporting to it may cause the exported files to be corrupted or incomplete.

- 1 If exporting, wait at least five seconds after the USB animation icon  stops.
- 2 Remove the USB memory stick from the port.

General interaction

Clinical monitor

WARNINGS

- ▶ FUJIFILM SonoSite does not recommend using a monitor other than the clinical monitor provided by FUJIFILM SonoSite. Only the images presented on the clinical monitor are validated for the intended use of the device.
- ▶ Do not use a monitor connected through the external VGA or digital video out for medical diagnosis.

The clinical monitor displays the ultrasound image as well as details about the exam and system status.

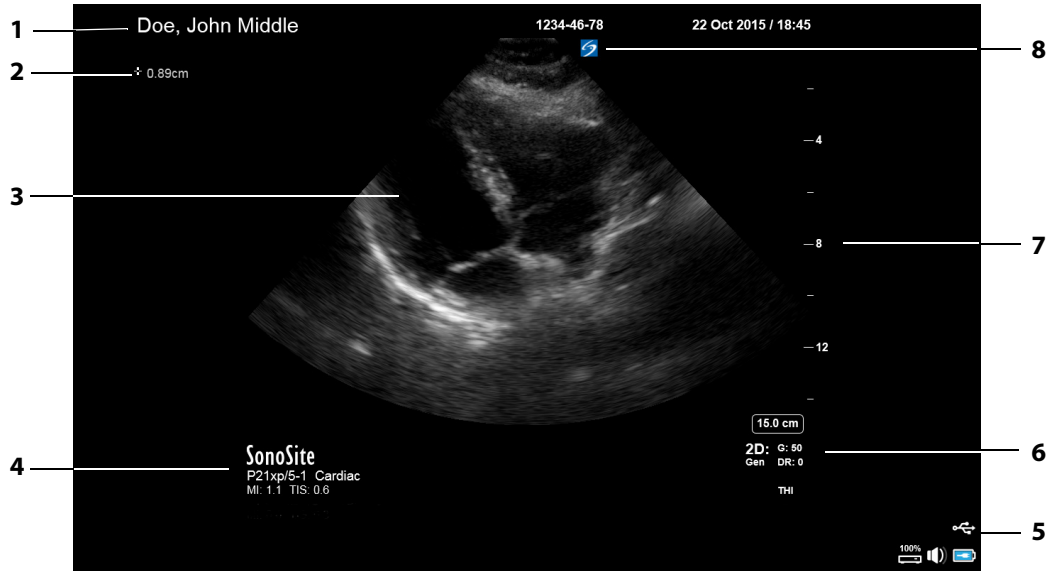

Figure 2-4 Clinical monitor layout

- | | | | |
|---|--|---|--|
| 1 | Patient header | 5 | System status area |
| 2 | Measurement and calculation area | 6 | Imaging mode or modes, controls selected |
| 3 | Ultrasound image | 7 | Depth scale |
| 4 | Selected transducer, exam type, and MI and TI values | 8 | Orientation marker |

VGA or digital video output

WARNINGS

- ▶ To avoid possible electrical shock or electromagnetic interference, verify proper operation and compliance with relevant safety standards for all equipment before clinical use. Connecting additional equipment to the ultrasound system constitutes configuring a medical system. FUJIFILM SonoSite recommends verifying that the system, all combinations of equipment, and accessories connected to the ultrasound system comply with relevant installation requirements and safety standards.
- ▶ For safety, FUJIFILM SonoSite recommends isolating auxiliary video connections with external devices; for example, optical or wireless interface adapters. Check the electrical safety of your system with a trained biomedical engineer prior to use.

WARNINGS

- ▶ FUJIFILM SonoSite does not recommend using a monitor other than the clinical monitor provided by FUJIFILM SonoSite. Only the images presented on the clinical monitor are validated for the intended use of the device.
- ▶ Do not use a monitor connected through the external VGA or digital video out for medical diagnosis.

Resolution

- ▶ VGA video output resolution is 1280 x 800 at 60 Hz (non-interlaced), Reduced Blanking.
- ▶ Digital video output resolution is 1920 x 1080 at 60 Hz.

Note

Digital video output is only available on the second monitor configuration. See “**Clinical monitor**” on page 9-33.

Touch panel

The touch panel is where you adjust settings; select the exam type, transducer, and imaging mode; enter patient information; and more. As you adjust the image settings or controls, the results appear on the clinical monitor. When an image is frozen, the touch panel displays an outline of the image.

You interact with the touch panel the same as with many other touchscreen devices:

- ▶ **Swipe**: Move your finger quickly across the panel. Faster than dragging.
- ▶ **Drag**: Move one or two fingers across the panel, usually to move an object from one location to another.
- ▶ **Tap**: Quickly touch the panel once; for example, to activate a control.
- ▶ **Double-tap**: Quickly touch the panel twice with one or more fingers.

- ▶ **Pinch or spread:** Slide two fingers together or apart on the panel.

Use these gestures to perform these actions:

Table 2-2: Gestures and actions



Gesture	Action	
Swipe	Steer D-line (linear transducers only)	
	Steer color box (linear transducers only)	
	Scroll through pages in forms, such as the patient form, worksheets, and thumbnails in Review	
	Select previous or next images in full-screen Review	
Drag	Adjust depth or gain	
	Move color or zoom box	
	Move calipers	
	Move D-line or M-line	
	Move Doppler baseline	
	With two or more fingers, drag anywhere on the touch panel to move or resize the active object, such as the Color box or the Doppler gate	
	Move depth marker in biopsy guide	
	Change the D-line angle selection	
	Move labels, pictograms, and transducer marker	
	Move through frames in the cine buffer	
	Move controls to the Controls bar	
	Pan a frozen zoomed 2D image (panning is disabled if measurements or labels exist on the frozen zoomed image)	
	Unfreeze a frozen image by dragging the Slide to Unfreeze slider	

Table 2-2: Gestures and actions (continued)

Gesture	Action	
Tap	Freeze	
	Adjust depth	
	Select calipers	
	Select image in dual	
	Select mode in split screen (2D, D-line, or Doppler trace)	
	Select control	
Double-tap	With two or more fingers, double-tap to freeze or unfreeze	
	Double-tap with one finger in the zoom box to zoom	
	Double-tap with one finger on a live zoomed image to unzoom	
Pinch or spread	Sample volume size	
	Resize color or zoom box	

Onscreen keyboard

You can enter text into text boxes (for example, on the patient form) using the onscreen keyboard.

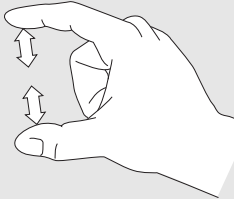
To enter text using the onscreen keyboard

1 Tap a text box (for example, in the patient form).

The onscreen keyboard appears.



2 Tap keys as needed.

- ▶ Tap and hold the alpha keys to reveal options for selecting accented versions of the characters
- ▶ Tap the shift key  to change alphabet keys to uppercase characters
- ▶ Tap **Previous** to jump to previous text box

- ▶ Tap **Next** to advance to next text box
- ▶ Tap  to display keys for numbers, symbols, and special characters

Note

To display international characters on the keyboard, tap , and then tap the shift key.

- ▶ Tap  to close the keyboard
- ▶ Tap  to start a new line or advance to next text box
- ▶ Tap  to delete a character on the left side of pointer

Preparing transducers

WARNINGS

- ▶ Some transducer sheaths contain natural rubber latex and talc, which can cause allergic reactions in some individuals. FUJIFILM SonoSite recommends that you identify your latex and talc-sensitive patients and be prepared to treat allergic reactions promptly.
- ▶ Some gels and sterilants can cause an allergic reaction on some individuals.

Cautions

- ▶ To avoid damage to the transducer, use only gels recommended by FUJIFILM SonoSite. Using other gels can damage the transducer and void the warranty. If you have questions about gel compatibility, contact FUJIFILM SonoSite or your local representative.
- ▶ Clean transducers after each use (see **“Determining the required cleaning and disinfecting level”** on page 8-2).

Connecting transducers

This section provides instructions to connect a transducer, with or without the Triple Transducer Connect (TTC), as well as instructions to remove a transducer.

To connect a transducer to the TTC

The TTC is a three-transducer module that lets you simultaneously connect up to three transducers to the ultrasound system. The TTC is standard with the system.

- 1 Pull the transducer latch handle up, and rotate it clockwise.

2 Insert the transducer connector into one of the three TTC connector ports on the bottom of the TTC.

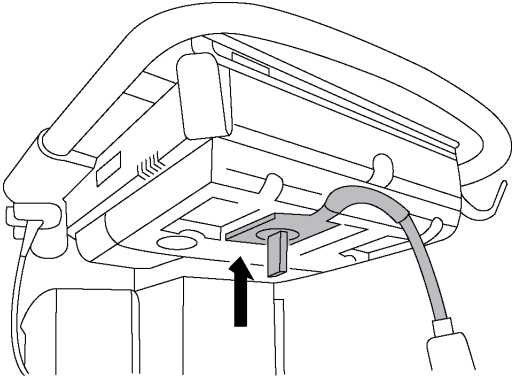

3 Make sure that the connector is firmly seated, and then turn the latch handle counterclockwise.

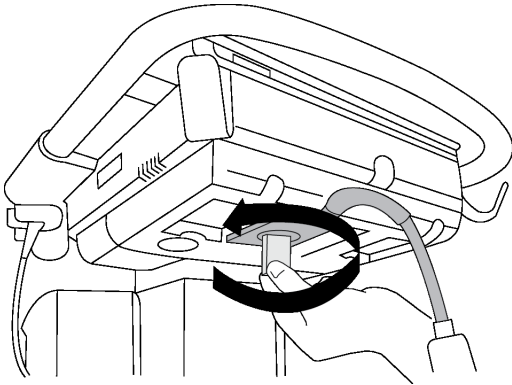

4 Press the latch handle up, securing the transducer connector to the TTC.

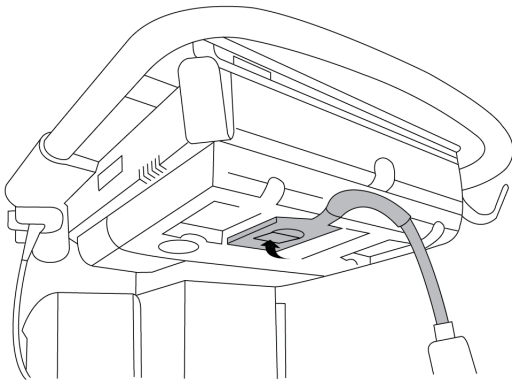

To connect a transducer to the system (without a TTC)

If the TTC is not installed on your system, you can connect one transducer directly to the system.

- 1 Pull the transducer latch up, and rotate it clockwise.
- 2 Insert the transducer connector into the transducer port underneath the stand platform.

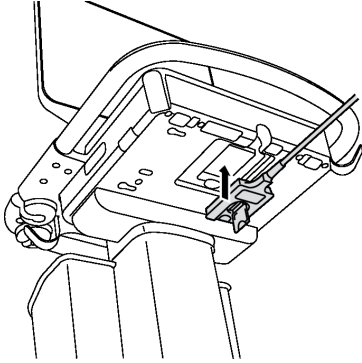

- 3 Make sure that the connector is firmly seated, and then turn the latch handle counterclockwise.

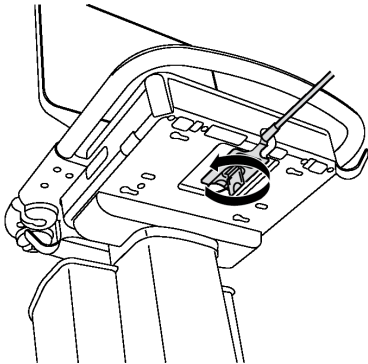

- 4 Press the latch up, securing the transducer connector to the system.

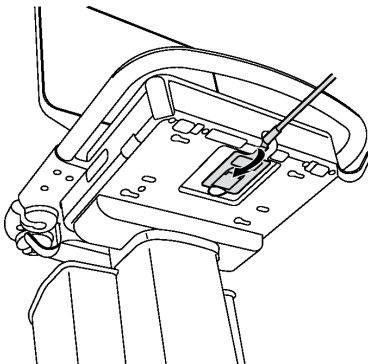

To remove a transducer

Caution

To avoid equipment damage that could lead to image quality degradation, do not disconnect a transducer while it is in use. Either freeze the image or switch to another transducer before disconnecting.

- 1 Pull the transducer latch up, and rotate it clockwise.
- 2 Pull the transducer connector away from the system.

Selecting a transducer and exam type

WARNING

To prevent misdiagnosis or harm to the patient, use the correct transducer for the application. The diagnostic capability differs for each transducer, exam type, and imaging mode. Transducers are developed to specific criteria depending on their physical application. These criteria include biocompatibility requirements. Understand the system's capabilities prior to use.

Before scanning, select a transducer and exam type.

To select a transducer and exam type

- 1 Do one of the following:
 - ▶ On the start select screen, tap **SELECT** if present. To set up the start select screen, see [“User profile settings”](#) on page 3-34.
 - ▶ Tap **TRANSDUCERS & EXAMS** at the top of the touch panel.

Cards for the available transducers appear (see [“Connecting transducers”](#) on page 2-24).

- 2 On the card for the appropriate transducer, do one of the following:
 - ▶ Double-tap the exam type.
 - ▶ Tap the exam type, and then tap **SCAN**, or tap **Cancel** to cancel.

Scrolling the list of exam types displays any hidden items.

You can also select the exam type on the patient form (see [“Entering patient information”](#) on page 4-33).

Table 2-3: Imaging modes and exam types on transducers

Transducer	Exam type	Imaging mode			
		2D M Mode	Color ^a	PW Doppler ^b	CW Doppler
D2xp ^c	Cardiac	—	—	—	✓
C11xp	Abdomen	✓	CVD, CPD	✓	—
	Arterial	✓	CVD, CPD	✓	—
	Neonatal	✓	CVD, CPD	✓	—
	Nerve	✓	CVD, CPD	✓	—
	Venous	✓	CVD, CPD	✓	—
C35xp ^d	Abdomen	✓	CVD, CPD	✓	—
	Musculoskeletal	✓	CVD, CPD	✓	—
	Nerve	✓	CVD, CPD	✓	—
C60xp ^d	Abdomen	✓	CVD, CPD	✓	—
	Gynecology	✓	CVD, CPD	✓	—
	Msk	✓	CVD, CPD	✓	—
	Nerve	✓	CVD, CPD	✓	—
	Obstetrics	✓	CVD, CPD	✓	—

Table 2-3: Imaging modes and exam types on transducers (continued)

Transducer	Exam type	Imaging mode			
		2D M Mode	Color ^a	PW Doppler ^b	CW Doppler
HFL38xp ^d	Arterial ^e	✓	CVD, CPD	✓	—
	Breast	✓	CVD, CPD	✓	—
	Lung	✓	CVD, CPD	✓	—
	Musculoskeletal	✓	CVD, CPD	✓	—
	Nerve	✓	CVD, CPD	✓	—
	Small Parts	✓	CVD, CPD	✓	—
	Venous ^e	✓	CVD, CPD	✓	—
HFL50xp ^d	Breast	✓	CVD, CPD	✓	—
	Musculoskeletal	✓	CVD, CPD	✓	—
	Nerve	✓	CVD, CPD	✓	—
	Small Parts	✓	CVD, CPD	✓	—

Table 2-3: Imaging modes and exam types on transducers (continued)

Transducer	Exam type	Imaging mode			
		2D M Mode	Color ^a	PW Doppler ^b	CW Doppler
HSL25xp	Arterial ^e	✓	CVD, CPD	✓	—
	Lung	✓	CVD, CPD	✓	—
	Musculoskeletal	✓	CVD, CPD	✓	—
	Nerve	✓	CVD, CPD	✓	—
	Ophthalmic	✓	CVD, CPD	✓	—
	Superficial	✓	CVD, CPD	✓	—
	Venous ^e	✓	CVD, CPD	✓	—
ICTxp ^d	Gynecology	✓	CVD, CPD	✓	—
	Obstetrics	✓	CVD, CPD	✓	—
L25xp ^d	Arterial ^e	✓	CVD, CPD	✓	—
	Lung	✓	CVD, CPD	✓	—
	Musculoskeletal	✓	CVD, CPD	✓	—
	Nerve	✓	CVD, CPD	✓	—
	Ophthalmic	✓	CVD, CPD	✓	—
	Superficial	✓	CVD, CPD	✓	—
	Venous ^e	✓	CVD, CPD	✓	—

Table 2-3: Imaging modes and exam types on transducers (continued)

Transducer	Exam type	Imaging mode			
		2D M Mode	Color ^a	PW Doppler ^b	CW Doppler
L38xp ^d	Arterial ^e	✓	CVD, CPD	✓	—
	Lung	✓	CVD, CPD	✓	—
	Nerve	✓	CVD, CPD	✓	—
	Small Parts	✓	CVD, CPD	✓	—
	Venous ^e	✓	CVD, CPD	✓	—
P10xp ^d	Abdomen	✓	CVD, CPD	✓	—
	Cardiac	✓	CVD, Var	✓	✓
	Neonatal	✓	CVD, CPD	✓	—
rP19xp ^d	Abdomen	✓	CVD, CPD	✓	—
	Cardiac	✓	CVD, Var	✓	✓
	Lung	✓	CVD, CPD	✓	—
	Obstetrics	✓	CVD, CPD	✓	—
	Orbital	✓	CVD, CPD	✓	—
	Transcranial	✓	CVD, CPD	✓	—

Table 2-3: Imaging modes and exam types on transducers (continued)

Transducer	Exam type	Imaging mode			
		2D M Mode	Color ^a	PW Doppler ^b	CW Doppler
P21xp ^d	Abdomen	✓	CVD, CPD	✓	—
	Cardiac	✓	CVD, Var	✓	✓
	Lung	✓	CVD, CPD	✓	—
	Obstetrics	✓	CVD, CPD	✓	—
	Orbital	✓	CVD, CPD	✓	—
	Transcranial	✓	CVD, CPD	✓	—
TEExp ^f	Cardiac	✓	CVD, Var	✓	✓

^aColor Doppler Variance (Var) is available in the cardiac exam only. Color Power Doppler (CPD) is available in all exams except the cardiac exam type. Color Velocity Doppler (CVD) is supported on all transducers except for D2xp.

^bFor the cardiac exam type, PW TDI is also available.

^cMake sure you unscrew the D2xp stabilization handle before moving the transducer from its parked position.

^dNeedle guide-capable. For more information, refer to *Using CIVCO Products with FUJIFILM SonoSite Systems*.

^eAvailable with simultaneous Doppler imaging. See **"Simultaneous Doppler"** on page 4-7.

^fFor more information refer to the *TEExp Transducer User Guide*, included with the TEEp transducer.

Gel

Use acoustic coupling gel on the transducer during exams. Although most gels provide suitable acoustic coupling, some gels are incompatible with some transducer materials. FUJIFILM SonoSite recommends Aquasonic gel and provides a sample with the system.

For general use, apply a liberal amount of gel between the transducer and the body. For interventional use, apply a transducer sheath.

Sheaths

WARNING

Use market-cleared, sterile transducer sheaths and sterile coupling gel for transrectal, transvaginal, or guided-needle procedures. Do not apply the transducer sheath and coupling gel until you are ready to perform the procedure. After use, remove and discard the single-use sheath, and clean and disinfect the transducer using a FUJIFILM SonoSite-recommended disinfectant. See the cleaners and disinfection document available at www.sonosite.com for a complete list of the most current cleaners and disinfectants.

To apply a transducer sheath

- 1 Place gel inside the sheath. Make sure that the gel is at the end of the sheath.
- 2 Insert the transducer into the sheath.
- 3 Pull the sheath over the transducer and cable until the sheath is fully extended.
- 4 Secure the sheath using the bands supplied with the sheath.
- 5 Check for and eliminate air bubbles between the face of the transducer and the sheath.

Air bubbles between the face of the transducer and the sheath may affect the ultrasound image.

- 6 Inspect the sheath to ensure that there are no holes or tears.

Ports

Two dock configurations are now available. The dock provides ports for various applications (see [Figure 2-5](#) on page 2-33 and [Figure 2-6](#) on page 2-34).

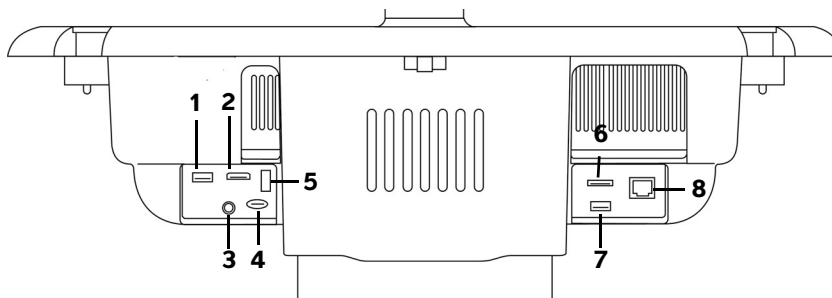

Figure 2-5 Back of system with first dock configuration: 1. USB 2. Digital video in 3. Audio in 4. MicroSD - DVR software upgrade 5. USB storage - DVR 6. E-SATA (unsupported) 7. USB 8. Ethernet

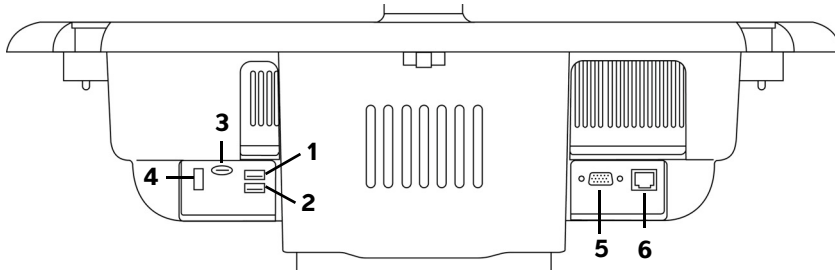









Figure 2-6 Back of system with second dock configuration: 1. USB 2. USB 3. MicroSD - DVR software upgrade 4. USB storage - DVR 5. VGA out 6. Ethernet

Each connector has a symbol that describes its use:

-  USB
-  Ethernet
-  MicroSD - DVR software upgrade
-  USB storage - DVR
-  VGA out
-  Digital video in
-  Audio in

Battery charge indicator

Cautions

- ▶ Connect the system to AC power when the battery charge is low.
- ▶ Periodically check to make sure that the battery charges fully. If the battery fails to charge fully, contact FUJIFILM SonoSite Technical Support (see [“Getting help”](#) on page 1-3).
- ▶ Use only FUJIFILM SonoSite batteries with the system.

The battery charge indicator on the base of the stand blinks while the battery is charging. The battery charging indicator is steady when the battery is fully charged. Icons in the connectivity status area on the clinical monitor show the power and battery status:



The battery is partially charged. The length of the blue bar indicates the level of battery charge. The example illustrates a battery charge of 25%. If Beep Alert is on (see [“Audio settings”](#) on page 3-6), the system beeps when the battery charge is below 14%.



The system is on AC power only, either because the batteries are switched off or because no batteries are installed.



The system is on AC power, and the battery is charged. The length of the blue bar indicates the level of the battery charge.

Transporting the system

If you need to transport the system, make sure to observe the following:

- ▶ Collapse the clinical monitor (see [“To collapse the clinical monitor”](#) on page 2-18).
- ▶ To wheel the system, push forward on the bar on the platform instead of pushing downward on the bar or pushing the clinical monitor.

Caution

Make sure to turn the battery switches off before transporting the system for shipping: Open the battery compartment door located at the base of the stand and depress all three battery switches to the **•O** symbol, which is the OFF position.

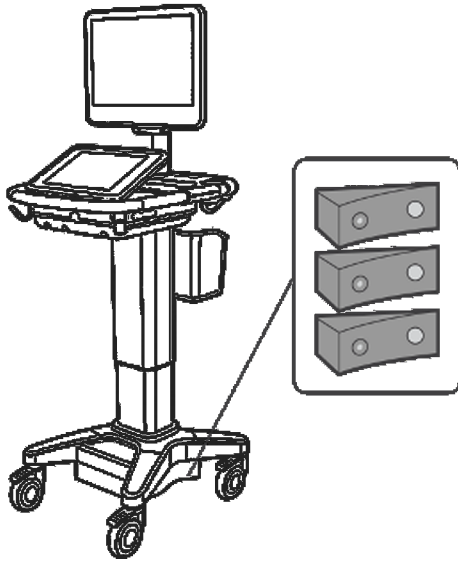

Figure 2-7 Battery switches in off positions

Visual Guide videos

The Visual Guide library contains animated 3D videos that describe scanning techniques, terminology, and more. Scanning is active while a video plays, so you can practice scanning techniques in conjunction with the visual guides.

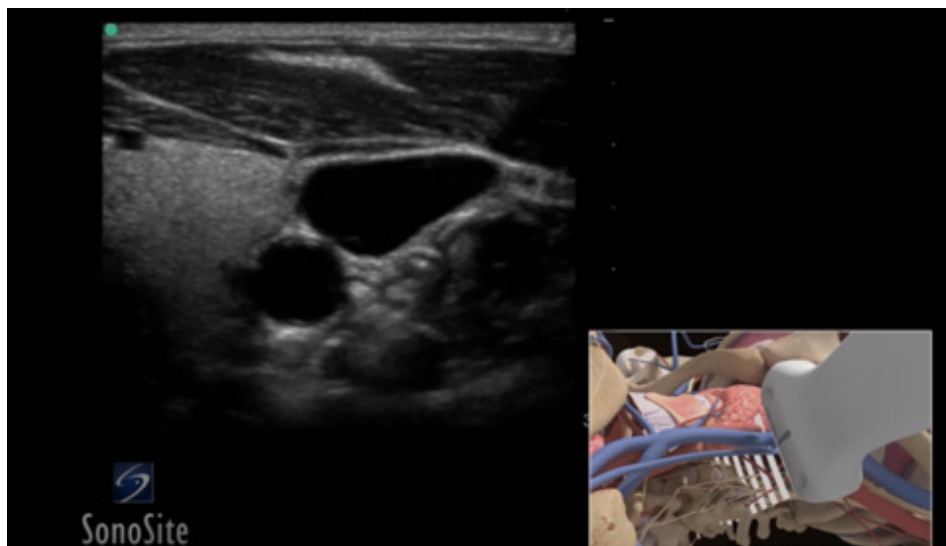

Figure 2-8 A Visual Guide video

Note

Some Visual Guide videos may display incorrect representations of the SonoSite X-Porte user interface due to using different versions of the software.

To play a Visual Guide video

1 Display the Visual Guide screen by doing one of the following:

- ▶ Tap **LEARN** on the startup screen.
- ▶ In the upper right corner of the touch panel, tap **LEARN**, or tap **MORE** and then tap **LEARN**, depending on your setup.

To specify the location of this command, see [“Presets settings”](#) on page 3-31.

2 At the top of the Visual Guide screen, tap a category (for example, **Basics**).

The current selection is highlighted.

3 Tap a video selection in one of the cards that appear.

4 Tap the left and right controls to show additional cards.

The video player starts. Tap the play button to play your selection.

5 Do any of the following:

- ▶ Pause or restart the video using the controls at the bottom of the player.
- ▶ Tap the volume control to mute the audio. Tap again to unmute.
- ▶ Drag the volume slider to adjust the volume.
- ▶ Tap **Hide** to hide the player. (You can tap **LEARN** to show the player again.)
- ▶ Tap another video in the list to play it.
- ▶ Tap **LEARN** to return to the Visual Guide screen.

CHAPTER 3

Setting up the system

System Settings is where you customize the system and set preferences.

Notes

- ▶ Not all system settings are available if you log in to the system as a guest (see “[Logging in](#)” on page 3-6).
- ▶ Reset functions are provided on some system settings pages. For example, you can reset the More Controls window for your user profile to the factory default. For more information about user profile settings, see “[User profile settings](#)” on page 3-34.

To display a settings page

- ❖ Tap **MORE**, and then tap **System Settings**.



Tapping a settings page in the list displays its settings on the right side. The active selection is highlighted.

Administration settings

On the Administration settings page, you can configure the system to manage the system’s internal storage by auto-deleting archived exams. You can also require users to log in and enter passwords, add and delete users, and change their passwords. Required login helps protect patient information.

To display the Administration Login settings page

- 1 Tap **MORE**, and then tap **System Settings**.
- 2 Tap **Administration** in the list on the left.



About security settings

Caution

Healthcare providers who maintain or transmit health information are required by the Health Insurance Portability and Accountability Act (HIPAA) of 1996 and the European Union Data Protection Directive (95/46/EC) to implement appropriate procedures: to ensure the integrity and confidentiality of information and to protect against any reasonably anticipated threats or hazards to the security or integrity of the information or unauthorized uses or disclosures of the information.

The Administration settings page includes security settings that help you to meet the applicable security requirements listed in the HIPAA standard. Users are ultimately responsible for ensuring the security and protection of all electronic protected health information collected, stored, reviewed, and transmitted on the system.

Managing the Administrator account

To log in as Administrator

The default Administrator login name is **Administrator**. If you don't have the administrator password, contact FUJIFILM SonoSite (see [“Getting help”](#) on page 1-3).

WARNING

Restoring an administrative password will result in the deletion of data. Back up all data prior to resetting the administrative password.

Any user with administrative privileges can log in as an administrator.

- 1 On the **Administration Login** settings page, type the login name of a user with administrative privileges in the **Name** text box.
- 2 Type the password for the login name in the **Password** text box.
- 3 Tap **Login**.

To log out as Administrator

Do one of the following:

- ▶ Tap any other settings page.
- ▶ Turn off or restart the system.

To change the administrator password

- 1 On the **Administration Login** settings page, log in as a user with administrative privileges.
- 2 Under **User List**, tap **Administrator**.

- 3 Type the new password in the **Password** text box and in the **Confirm** text box.
- 4 To ensure security, choose a password that contains uppercase characters (A-Z), lowercase characters (a-z), and numbers (0-9). Passwords are case-sensitive.
- 5 Tap **Save**.

Protecting patient information

To require user login

You can set the system to require a user name and password at startup. If you require user login, you also need to set up user accounts (see [“Adding and managing user accounts”](#) on page 3-3).

- 1 On the **Administration Login** settings page, log in as a user with administrative privileges.
- 2 Select **On** from the **User Login** list.
- 3 Tap **Done**.

To hide patient information

You can choose not to display the patient name and ID number on the clinical monitor and to remove it from exported images and video clips.

- 1 On the **Administration Login** settings page, log in as a user with administrative privileges.
- 2 Tap **Administrator** in the **User List**.
- 3 Select **Disable Patient Header**.
- 4 Tap **Save**.

To disable export and recording of patient data

You can prevent users from exporting patient data to USB memory sticks and from recording video displayed on the clinical monitor to a USB memory stick inserted in the DVR (see [“DVR recording”](#) on page 4-49).

- 1 On the **Administration Login** settings page, log in as a user with administrative privileges.
- 2 Tap **Administrator** in the **User List**.
- 3 Select **Disable USB Export**.
- 4 Tap **Save**.

Adding and managing user accounts

You can add up to 20 user accounts (including the default Administrator account).

To add a new user

Note

Once you add a new user, you cannot edit the user's name.

- 1 On the **Administration Login** settings page, log in as a user with administrative privileges.
- 2 Tap **New**.
- 3 Under **User Information**, fill in the **Name**, **Password**, and **Confirm** text boxes.
- 4 To ensure security, choose a password that contains uppercase characters (A-Z), lowercase characters (a-z), and numbers (0-9). Passwords are case-sensitive.
- 5 (Optional) In the **User** box, type the user's name. This information appears by default in the **User** field in the patient form and on the clinical monitor.
- 6 (Optional) Select **Administration Access** to allow access to all administration privileges.
- 7 Tap **Save**.
- 8 Tap **Done**.

To modify a user

- 1 On the **Administration Login** settings page, log in as a user with administrative privileges.
- 2 Under **User List**, select the user.
- 3 Make changes to the **Name**, **User**, or **Administration Access** entries.
- 4 Tap **Save**.
- 5 Tap **Done**.

To change a user password

- 1 On the **Administration Login** settings page, log in as a user with administrative privileges.
- 2 Under **User List**, select the user.
- 3 Type the new password in the **Password** and **Confirm** text boxes.
- 4 Tap **Save**.
- 5 Tap **Done**.

To allow users to change their password

- 1 On the **Administration Login** settings page, log in as a user with administrative privileges.
- 2 Under **User List**, tap **Administrator**.
- 3 Select **Password Changes**.

4 Tap **Save**.

5 Tap **Done**.

To delete a user

1 On the **Administration Login** settings page, log in as a user with administrative privileges.

2 Select the user under **User List**.

3 Tap the delete icon.

4 Tap **Yes**.

5 Tap **Done**.

Configuring Auto Delete

To configure Auto Delete settings

1 On the **Administration Login** settings page, log in as a user with administrative privileges.

2 Tap **Auto Delete**.

The **Auto Delete Settings** page appears.

3 Under **Auto Delete**, select one of these choices:

▶ **On**

▶ **Off (manual)**

This is the default option.

4 Select the type of study to delete:

▶ **Storage Committed studies only**

▶ **Archived studies only**

▶ **All studies**

5 Select the age of the studies to delete:

▶ **24 hours old**

▶ **3 days old**

▶ **7 days old**

▶ **28 days old**

6 Tap **Save** and confirm your selection.

Auto Delete will occur daily at midnight or at first boot up.

Logging in

If user login is required, the user login screen appears when you turn on the system (see [“To require user login”](#) on page 3-3).

To log in as a user

- 1 Turn on the system.
- 2 In the login screen, type your user name and password, and then tap **OK**.

To log in as guest

Guests can scan, save images and clips, view worksheets, and access Help and Visual Guide videos. Guests cannot access patient information or system settings (except **Monitor Brightness** and **Touch Panel Brightness**).

When you log in as a guest, the system always displays the 2D imaging screen, no matter which startup mode is specified in User Profile settings (see [“User profile settings”](#) on page 3-34).

- 1 Turn on the system.
- 2 In the login screen, tap **Guest**.

To change your password

You can change your password only if the administrator has enabled password changes (see [“To allow users to change their password”](#) on page 3-4).

- 1 Turn on the system.
- 2 In the login screen, tap **Change Password**.
- 3 Type your old and new passwords, confirm the new password, and then tap **Change**.

Audio settings

On the **Audio settings** page, you can specify sound settings and adjust the volume for beeps and clicks.

To display the Audio settings page

- 1 Tap **MORE**, and then tap **System Settings**.
- 2 Tap **Audio** in the list on the left.



To specify sound settings

- ❖ On the **Audio settings** page, do either or both of the following:
 - ▶ Select **Button Clicks** for keys to click when tapped.
 - ▶ Select **Beep Alert** for the system to play sounds.

To adjust the volume for beeps and clicks

- ❖ On the **Audio settings** page, drag the **Beeps and Clicks Volume** slider. To mute the volume for Beeps and Clicks, tap the volume control to mute the audio. Tap again to unmute.

Calculations settings

On the **Calculations** settings page, you can specify measurement names that appear in the Tissue Doppler Imaging (TDI) calculations list and in the reports for cardiac exams.

You can select authors for obstetrics calculation tables and import custom obstetrics calculation tables.

You can also set up obstetrics custom measurements that appear in the obstetrics calculations lists and in the report for obstetrics exams.

To display the Calculations settings page

- 1 Tap **MORE**, and then tap **System Settings**. Tap **Calculations** in the list on the left.



Cardiac calculations settings

To specify cardiac measurement names

- 1 On the **Calculations** settings page, tap **Cardiac**.
- 2 Under **TDI Walls**, select a name for each wall.
- 3 Tap **Done**.

Obstetrics calculations settings

To specify gestational age and growth analysis

- 1 On the **Calculations** settings page, tap **OB**.

- 2 Select the desired authors (or select **None**) in the measurement lists under **Gestational Age** and **Growth Analysis**.
- 3 Selecting a gestational age author places the associated measurement in the calculations list.
- 4 To reset the authors for the **Gestational Age** and **Growth Analysis** measurement lists to the factory default, tap **Reset**.

Creating custom obstetrics measurements and tables

You can create up to five custom measurements that appear in the obstetrics calculations lists, in the list of custom measurements in Calculations settings, and in the obstetric report.

You can create custom measurements on the system or in the SonoSite X-Porte OB Custom Table Editor, a Microsoft Excel file available at www.sonosite.com. You can associate table data with a custom measurement only if you create the measurement in the OB Custom Table Editor.

Export custom measurements and tables created on the OB Custom Table Editor to a USB memory stick and then import custom measurements and tables onto your system.

WARNINGS

- ▶ When you import custom obstetric tables and measurements, the system replaces existing tables with tables from the OB Custom Table Editor.
- ▶ When you create, remove, or import a custom obstetric measurement, the system clears all saved measurements and calculations for the current patient.
- ▶ Prior to use, verify that custom table data entries are correct. The system does not confirm the accuracy of the custom table data entered by the user.

To create custom obstetrics measurements and tables in the OB Custom Table Editor

You can set up custom tables of up to 120 entries (age tables) or 210 entries (growth tables). Before you use the SonoSite X-Porte OB Custom Table Editor, make sure that your computer meets the following minimum requirements:

Windows

- ▶ Windows Vista, 32-bit or 64-bit, or later
- ▶ Microsoft Excel 2007 or later, configured to enable all macros and to trust access to the VBA project object model (see Excel Help for instructions).

Mac OS

- ▶ Mac OS X 10.5 (Leopard) or later
- ▶ Microsoft Excel 2011 or later

Entries in the table editor cannot be negative and cannot contain slashes, asterisks, brackets, commas, or semicolons.

WARNING Prior to use, verify that custom table data entries are correct. The system does not confirm the accuracy of the custom table data that you enter.

- 1 Open the editor in Excel.
- 2 Enable macros:
 - ▶ (Windows) Click **Enable Content** after the Security Warning at the top of the page.
 - ▶ (Mac OS) Click **Enable Macros**.
- 3 If needed, specify the language of the editor by selecting a language from the **Please Specify Language** list located on the **Setup-First** tab.

The language selected must match the language of the SonoSite X-Porte system on which you import the tables.

- 4 On the **Setup-First** tab, click the Growth or Age table that you want to edit.
- 5 Enter a unique name with a maximum of 24 characters in the **Author** field. You cannot use author names that occur in system-defined OB calculation tables.
- 6 Do one of the following:

- ▶ (Growth tables) Enter values in the **Weeks**, **Min**, **Mid**, and **Max** fields.

Values in the **Weeks** column must increase.

- ▶ (Age tables) Enter values in the **Value**, **Age (weeks)**, **Age (days)**, **Range (weeks)**, **Range (days)**, **Measurement Name**, and **Measurement Type** fields.

Values in the **Value** column and the totals of the values in the **Age (weeks)** and **Age (days)** columns must increase.

A graphical representation of the values you enter appears to the right of the cells in each tab.

Note If you create a custom measurement with a name that matches the name of a custom measurement already on the system, the system overwrites the custom measurement on the system with the new custom measurement when you import it.

- 7 Save the file to a location on your hard drive.
- 8 Export the file to a USB memory stick:
 - a Click **Export** on any tab in the editor.

- b** In the **Please Select the Export File Folder** window, navigate to the USB memory stick and click **OK**. You cannot change the file name of the exported file.

Note

Do not modify the exported CSV file. The system will not import data from the CSV file if the file has been modified.

- 9** Import the file to the system:
 - a** End the current exam if needed.
 - b** Insert the USB memory stick that contains the exported CSV file into a USB port on the side of the system.
 - c** On the Calculations settings page, tap **Tables**.
 - d** Tap **Import**.
 - e** Select the USB memory stick that contains the CSV file, and then tap **Import**.
The system restarts.

To create custom obstetrics measurements on the system

- 1** End the current exam.
- 2** On the **Calculations** settings page, tap **OB**.
- 3** In the **OB Custom Measurements** area, tap **Add New**.
- 4** In the **Name** box, type a unique name.
- 5** In the **Type** list, select the desired measurement type.
- 6** Tap **Save**.

Viewing obstetric calculation tables

You can view obstetric calculation tables on the system, including tables you've imported using the OB Custom Table Editor.

To view obstetric calculations tables

- 1** On the **Calculations** setup page, tap **Tables**.
- 2** Select the desired table type and measurement/author.

Deleting custom obstetric measurements and tables

You cannot modify or delete system-defined obstetric tables.

To delete a custom obstetric measurement

- 1** End the current exam.

- 2 On the **Calculations** setup page, tap **OB**.
- 3 In the **OB Custom Measurements** area, tap the delete icon next to the measurement you want to delete.
- 4 Tap **Yes** to confirm the deletion.

The measurement and its associated table is removed from the system.

To delete a custom obstetric table

- 1 On the **Calculations** settings page, tap **Tables**.
- 2 Select **Gestational Age** or **Growth Analysis**, and then select the **Measurement** and **Author** for the table you want to delete.
- 3 Tap **Delete**.

CDA Report settings

When you select **Include CDA** on the DICOM **Archivers** configuration page, the ultrasound system archives the patient report in DICOM Encapsulated CDA (Clinical Document Architecture) format using the profile you specify on the **CDA Report** settings page.

Some CDA report settings appear in the patient report (see “[Displaying reports after the exam has ended](#)” on page 5-54). For example, the **Custodian/Provider Organization Name** appears in the report's banner.

You can configure up to four CDA profiles on the system.

To display the CDA Report settings page

- 1 Tap **MORE**, and then tap **System Settings**.
- 2 Tap **CDA Report** in the list on the left.



To configure a CDA profile

Required fields are marked with asterisks.

- 1 On the **CDA Report** settings page, tap **Config**.
- 2 On the **CDA Report** page, tap **New**.
- 3 To change the profile name, type a new profile name in the **System/Author ID** box. Each profile name must be unique.

- 4 Complete the fields in the **Custodian/Provider Organization** and **Author/Authenticator Organization** sections.
- 5 To enter information about the authenticator, select **Include?** in the **Authenticator** section and complete the fields in the **Authenticator** section.
- 6 Tap **Save**.

To specify a CDA profile

- ❖ On the **CDA Report** settings page, select a profile from the **Active Configuration** list.

To delete a CDA profile

- 1 On the **CDA Report** settings page, tap **Config**.
- 2 Select the CDA profile you want to delete in the **CDA List**, and tap **Delete**.

Related topics

DICOM 3-14

Connectivity settings

On the **Connectivity** settings page, you specify the system location, and specify options for alerts when internal storage is full. You can also import and export connectivity settings.

You can also manage wireless certificates and specify settings for DICOM, which is an optional feature. See **“DICOM”** on page 3-14.

To display the Connectivity settings page

- 1 Tap **MORE**, and then tap **System Settings**.
- 2 Tap **Connectivity** in the list on the left.



To specify the system location

The location you specify in **Connectivity** settings represents the active location of the system.

- ❖ On the **Connectivity** settings page, select a location from the **Location** list.

To receive storage alerts

Caution

If the save available icon  does not appear in the system status area, internal storage may be defective. Contact FUJIFILM SonoSite Technical Support (see “Getting help” on page 1-3).

- ❖ On the **Connectivity** settings page, select **Internal Storage Capacity Alert**.

The system displays a message if internal storage is near capacity when you end an exam.

Related topics

DICOM	3-14
Network Status settings	3-30

Importing and exporting connectivity settings

You can import and export all location and connectivity settings from and to another SonoSite X-Porte system. These settings include DICOM configuration data for locations, wireless settings, archivers, printers, storage commit servers, worklist servers, and MPPS servers.

The system does not import IP addresses or AE titles when you import configuration data from another system.

Caution

To avoid losing data from or damaging the USB memory stick, do not remove the USB memory stick or turn off the ultrasound system while exporting. In addition, do not bump or apply pressure to the USB memory stick while it is connected to the system. The connector could break.

To import connectivity settings

- 1 Connect the USB memory stick that contains the settings (see “[To connect a USB memory stick for importing or exporting](#)” on page 2-19).
- 2 On the **Connectivity** settings page, tap **DICOM Setup**.
- 3 Tap **Config**.
- 4 Tap **Import**.
- 5 Select the USB memory stick, and then tap **Import**.

The system restarts. All configurations on the system are replaced with imported data.

To export connectivity settings

- 1 Connect a USB memory stick (see [“To connect a USB memory stick for importing or exporting”](#) on page 2-19).
- 2 On the **Connectivity** settings page, tap **DICOM Setup**.
- 3 Tap **Config**.
- 4 Tap **Export**.
- 5 Select the USB memory stick, and then tap **Export**.

All configurations on the USB memory stick are replaced with exported data. Five seconds after the exporting completes, you can safely remove the USB memory stick and use it to import the data onto another SonoSite X-Porte system.

DICOM

Using data in the Digital Imaging and Communications in Medicine (DICOM) standard, the ultrasound system can do the following:

- ▶ Transfer patient exam data to an archiver, DICOM printer, or storage commitment server (see [“Archiving and exporting”](#) on page 4-44).
- ▶ Import patient data from a worklist (see [“Entering patient information”](#) on page 4-33).
- ▶ Export exam data as DICOMDIR files to a USB storage device (see [“USB settings”](#) on page 3-39).

The system conforms to the DICOM standard as specified in the *Sonosite X-Porte DICOM Conformance Statement*, available at www.sonosite.com.

The *Sonosite X-Porte DICOM Conformance Statement* provides information about the purpose, characteristics, configuration, and specifications of the network connections supported by the system.

The system connects over a local area network (LAN) to the following:

- ▶ Picture Archive and Communication Systems (PACS) archivers
- ▶ Worklist servers
- ▶ Modality Performed Procedure Step (MPPS) servers
- ▶ DICOM printers
- ▶ Storage commitment servers

The system can transfer to one or more devices and connect to different networks, depending on how you configure it. The DICOM log collects network errors and events, typically to support diagnostics (see [“Logs”](#) on page 3-28).

Related topics

Logs	3-28
CDA Report settings	3-11
Connectivity settings	3-12
Network Status settings	3-30
Routing selections	3-36

Configuring the system for DICOM transfer

To configure the system for DICOM transfer, you do the following tasks (typically completed by a network administrator or PACS manager):

- 1 Back up default DICOM configuration settings to a USB memory stick kept in a secure location. You can revert to the default settings if necessary. See [“Importing and exporting connectivity settings”](#) on page 3-13.
- 2 Connect to the network. See [“Connecting to the network”](#) on page 3-15.
- 3 Complete the configuration pages for locations and devices. See [“DICOM configuration pages”](#) on page 3-17.
- 4 Associate devices with locations. See [“Associating devices with locations”](#) on page 3-26.

Connecting to the network

Before configuring the system for DICOM transfer, you must connect to the network. You can connect by Ethernet or wirelessly.

To connect to the network by Ethernet

The SonoSite X-Porte ultrasound system must be connected to a standard Ethernet 10/100/1000 network.

Devices connected to the system’s Ethernet port must comply with the IEC 60601-1 or IEC 60950 standards.

- 1 Connect the Ethernet cable to the Ethernet port on the back of the dock (see [“Ports”](#) on page 2-33).
With the system on, the LAN link light (green LED) next to the Ethernet connector indicates physical connection to the network.
- 2 See [“DICOM configuration pages”](#) on page 3-17 to configure and save a location with the correct network settings.

To connect to the network wirelessly

Wireless connectivity is a licensed feature. See “[DICOM configuration pages](#)” on page 3-17 for a complete list of the wireless configuration fields.

- 1 Tap **MORE**, and then tap **System Settings**.
- 2 Tap **Connectivity** in the list on the left.
- 3 On the **Connectivity** settings page, tap **DICOM Setup**.
- 4 Tap **Config**, then select **Location**.
- 5 On the DICOM **Location** page, tap **New** to configure a new wireless connection.
- 6 Edit the information fields, as needed.
- 7 Select the desired settings under **Transfer images** and **JPEG Compression**.
- 8 Select 2.4 GHz, 5 GHz, or both from the **Network** type.
- 9 (Optional) On the DICOM **Location** page, select **FIPS** if configuring a Federal Information Processing Standards wireless connection.

Notes

- ▶ You must have a Wireless and Security Module installed to use FIPS. See the *Wireless and Security Adapter Installation Instructions* that come in the Wireless and Security Module kit.
- ▶ FIPS is not available with LAN.
- ▶ Selecting FIPS restricts the available **Security Policy** choice on the next page to **WPA2**, the Encryption to AES, and the Authentication Type to EAP-TLS. All Profiles associated with a Location must have a WPA2 Security Policy, an AES Encryption, and an EAP-TLS Authentication Type (for WPA2-Enterprise only) before the FIPS option is enabled.

- 10 Select **DHCP** to automatically provide configuration information.
- 11 Tap **Wireless Configuration....**
- 12 On the next page, tap **New**.
- 13 Edit the information fields, as needed.
- 14 Select an **Authentication Type**, **Client Certificate**, **Private Key**, and **Certification Authority** under the drop down menus.

Note

These are available if you have imported wireless certificates to your system.

- 15 Enter your password.
- 16 Tap **Save**.

17 Tap **Done** to exit system settings.

Note

If a wireless connection has already been configured, select it from the wireless drop down list on the DICOM **Location** page.

18 Restart the system to enable the new connection.

The wireless icon  indicates the status of the wireless connection (the number of white bars indicates the strength of the connection).

(Optional) To import or delete wireless certificates

If your security scheme requires it, you can import wireless certificates. The system supports the following file types: CER, PFX, and PVK.

Caution

To avoid losing data from or damaging the USB memory stick, do not remove the USB memory stick or turn off the ultrasound system while exporting. In addition, do not bump or apply pressure to the USB memory stick while it is connected to the system. The connector could break.

1 Tap **MORE**, and then tap **System Settings**.

2 Tap **Connectivity** in the list on the left.

3 On the **Connectivity** setup page, tap **Wireless Certificates**.

A list of certificates on the system appears.

4 Do one of the following:

- ▶ Import certificates: Connect the USB memory stick that contains the certificates (see **“To connect a USB memory stick for importing or exporting”** on page 2-19). Verify that the certificates on the system, plus those on the USB memory stick, do not exceed 20. Delete certificates if necessary. Then tap **Import**.

Note

Certificates on the USB memory stick replace certificates on the system.

- ▶ Delete certificates: Select the certificates to delete, and then tap **Delete**

5 Tap **Done**.

6 Restart the system.

DICOM configuration pages

The DICOM configuration pages are as follows:

- ▶ **Location** Configuration for network settings, including settings for a wireless network connection. Also specifies which devices you want to associate with that network. For example, configure a location called “Office,” and then associate a printer and archiver with it. You can configure up to eight locations (see “[Associating devices with locations](#)” on page 3-26).
- ▶ **Archive** Configuration for PACS archivers, devices for storing patient exams (images and clips). Only one archiver per location can receive in-progress image transfers. You can associate up to four archivers per location.
- ▶ **Printer** Configuration for DICOM printers for printing images. You can associate up to two printers per location.
- ▶ **Storage Commit** Configuration for storage commitment servers, devices that take responsibility for and provide receipt of content sent by the ultrasound system.
- ▶ **Worklist** Configuration for worklist servers, devices that contain scheduled patient procedure data. You can import the data into the patient form (see “[Entering patient information](#)” on page 4-33).
- ▶ **MPPS** Configuration for MPPS servers, devices that coordinate detailed information about the exam performed. You can associate one MPPS server per location.

To configure a new location or device

Note

Changing the configuration requires a system restart.

- 1 Tap **MORE**, and then tap **System Settings**.
- 2 Tap **Connectivity** in the list on the left.
- 3 On the **Connectivity** setup page, tap **DICOM Setup**.
- 4 Tap **Config**.
- 5 From the **DICOM** list, select a configuration page.
- 6 Tap **New**.
- 7 Complete the configuration setup fields, and tap **Save**.

To delete a location or device

- 1 On the proper configuration page, select the name from the list of locations or devices.
- 2 Tap **Delete**.
- 3 Tap **Yes** to confirm the deletion.
- 4 Tap **Done**.

Configuration setup fields

Location

Required fields are marked with asterisks.

▶ **Name**

Unique network name for the ultrasound system. The default is SonoSite.

▶ **Alias**

Name that identifies the network location of the ultrasound system.

▶ **AE Title**

DICOM Application Entity Title.

▶ **Port**

Device port number. IP port 104 is typically assigned for DICOM.

Select IPv4 or IPv6 to enable an internet protocol. You will see the following fields:

▶ **DHCP**

If desired, select to enable Dynamic Host Configuration Protocol. The IP Address, Subnet Mask, and Default Gateway fields become unavailable.

▶ **IP Address**

Unique identifier of the ultrasound system location. Cannot be between 127.0.0.0 and 127.0.0.8.

▶ **Subnet Mask**

Identifies a network subdivision. The default value is 255.255.0.0.

▶ **Default Gateway**

IP address where network connects to another network. Cannot be between 127.0.0.0 and 127.0.0.8.

▶ **DNS Address**

Domain Name Server address.

▶ **Transfer Images**

Specify when to transfer images: during or at end of exam.

▶ **JPEG Compression**

Select High, Medium, or Low. A high compression has a smaller file size but less detail. For best image quality, select Low. See [“Limitations of JPEG format”](#) on page 3-40.

▶ **Network**

Choose between 2.4 GHz, 5 GHz, or both.

▶ **Internet Security**

Under this tab, select one or more internet security options.

▶ **Wireless Configuration**

Select if configuring a wireless location.

The following fields are available for wireless network connections:

▶ **Profile Name**

Name of the profile set for this location. For each wireless location, you can have up to 10 profiles.

▶ **Network Name (SSID)**

Network Name Service Set Identifier for the router.

▶ **Security Policy**

Security type that authenticates the network:

- ▶ **Open** No security.
- ▶ **WEP** or **Shared WEP** The following fields appear:
 - ▶ **Encryption** Encryption key type (64 bit or 128 bit)
 - ▶ **Key index** WEP key index 1-4. Network location where a specific key is stored.
 - ▶ **Key** WEP key value used to encrypt data.
- ▶ **RADIUS** Remote Access Dial-Up User Service -802.1x Key Exchange. The following fields appear:
 - ▶ **Authentication Type** Select one of the following:
 - ▶ **EAP-TLS** Extensible Authentication Protocol-Transport Layer Security. The following fields appear:
 - ▶ **User Name** Name of designated user.
 - ▶ **Client Certificate** Select from the list of client certificates installed on the system.
 - ▶ **Private Key** One of a pair of keys (public and private) that is provided only to the requestor and never shared.
 - ▶ **Private Key Password** A unique combination of letters and symbols that allows user access.
 - ▶ **Certification Authority** Validates the authentication server or certificate authority. The list is populated by wireless certificates that you have imported (see “**(Optional) To import or delete wireless certificates**” on page 3-17). Select the desired certificate from the list.
 - ▶ **EAP-PEAPv0**
 - ▶ **User Name** Name of designated user.
 - ▶ **Password** A unique combination of letters and symbols that allows user access.
 - ▶ **Certification Authority** Validates the authentication server or certificate authority. The list is populated by wireless certificates that you have imported (see “**(Optional) To import or delete wireless certificates**” on page 3-17). Select the desired certificate from the list.

- ▶ **WPA or WPA2** Wi-Fi Protected Access. The following fields appear:
 - ▶ **Authentication** If you select **PERSONAL**, the **Passphrase** field appears; enter the WPA Shared Key entry used in configuring the router.
 - ▶ **Encryption** Encryption protocol for the router.
 - ▶ **Authentication Type** Select one of the following:
 - ▶ **EAP-TLS** Extensible Authentication Protocol-Transport Layer Security. The following fields appear:
 - ▶ **User Name** Name of designated user.
 - ▶ **Client Certificate** Select from the list of client certificates installed on the system.
 - ▶ **Private Key** One of a pair of keys (public and private) that is provided only to the requestor and never shared.
 - ▶ **Private Key Password** A unique combination of letters and symbols that allows user access.
 - ▶ **Certification Authority** Validates the authentication server or certificate authority. The list is populated by wireless certificates that you have imported (see “**(Optional) To import or delete wireless certificates**” on page 3-17). Select the desired certificate from the list.
 - ▶ **EAP-PEAPv0** Extensible Authentication Protocol-Protected Extensible Authentication Protocol. The following fields appear:
 - ▶ **User Name** Name of designated user
 - ▶ **Password** A unique combination of letters and symbols that allows user access.
 - ▶ **Certification Authority** Validates the authentication server or certificate authority. The list is populated by wireless certificates that you have imported (see “**(Optional) To import or delete wireless certificates**” on page 3-17). Select the desired certificate from the list.

Archiver

Required fields are marked with asterisks.

- ▶ **Name**

Network host name for an archiver.

- ▶ **Alias**

Personalized name for an archiver.

- ▶ **AE Title**

Archiver DICOM Application Entity Title.

- ▶ **Images**

Defines how images are sent to the archiver: RGB (uncompressed), Mono (uncompressed), or JPEG.

▶ **Image Type**

List of archiver image types, based on capture mode.

▶ **IP Address**

Unique identifier for the archiver.

▶ **Port**

Device port number. IP port 104 is typically assigned for DICOM.

▶ **Ping**

Tap to determine whether the IP address is accessible. The system displays OK or Failed.

▶ **Exclude Video Clips**

If the check box is selected, only images (no video clips) are transferred. Available only if Image Type is set to Ultrasound.

▶ **Include CDA**

Select this check box to send the CDA report to the archiver.

▶ **Include SR**

Select this check box to send the Structured Report to the archiver.

▶ **Educational**

Select this check box to associate the archiver with the **Educational** routing select. See [“Routing selections”](#) on page 3-36.

▶ **Include private tags** If the archiver is a SonoSite software product (for example, SonoSite Workflow Solutions), select this check box to include private tags on images.

Note

Because the tags may be incompatible with some earlier archivers, keep this check box unselected unless you use SonoSite software products. For more information, see the conformance statement for your ultrasound system.

Printer

Required fields are marked with asterisks.

▶ **Name**

Network host name for a printer.

▶ **Alias**

Personalized name for a printer.

▶ **IP Address**

Unique identifier for the printer.

▶ **Port**

Device port number. IP port 104 is typically assigned for DICOM.

▶ **AE Title**

Printer DICOM Application Entity Title.

▶ **Ping**

Select to determine whether the IP address is accessible. The system displays OK or Failed.

▶ **Model**

List of Agfa, Codonics, and Kodak printer models. If your model is not listed, choose a generic model at the end of the list.

▶ **Film Size**

Film sizes supported by the printer.

▶ **Film Type**

Film medium supported by the printer.

▶ **Destination**

Location film is placed after it is printed.

▶ **Format**

Number of columns and rows in the image printout.

▶ **Orientation**

Film layout.

▶ **Settings**

Defines how images are sent to the printer, either as Color (RGB) or Monochrome images.

▶ **Copies**

Number of copies to print for each image.

▶ **Priority**

Importance of the print job.

▶ **Max**

Maximum density of the black value (in hundredths of optical density (OD)).

▶ **Min**

Minimum density of the white value (in hundredths of optical density (OD)).

▶ **Border**

Density of the areas surrounding and between film images (in hundredths of optical density (OD)).

▶ **Empty**

Empty image density (in hundredths of optical density (OD)).

▶ **Magnification**

Type of interpolation used during printing.

▶ **Configure**

Printer-specific configuration value. If using generic printer settings, no configuration strings are available.

Storage Commit

Required fields are marked with asterisks.

▶ **Name**

Unique network name for the Storage Commit server. Default is SonoSite.

▶ **Alias**

Name that identifies the network location of the Storage Commit server.

▶ **AE Title**

DICOM Application Entity Title.

▶ **IP Address**

Unique identifier of the storage commitment server.

▶ **Port**

Device port number. IP port 104 is typically assigned for DICOM.

▶ **Ping**

Tap to determine whether the IP address is accessible. The system displays OK or Failed.

Worklist

Required fields are marked with asterisks.

▶ **Name**

Network host name for a worklist server.

▶ **Alias**

Personalized name for a worklist server.

▶ **AE Title**

Application Entity Title.

▶ **Worklist**

Restricts the query to patient procedures that are scheduled for: Today; Yesterday, today, tomorrow; All.

▶ **This Device Only**

Restricts the query to patient procedures that are scheduled for the system based on its AE Title.

▶ **Modality**

US (Ultrasound) is the default procedure type.

▶ **IP Address**

Unique identifier for the worklist server.

▶ **Port**

Device port number. IP port 104 is typically assigned for DICOM.

▶ **Automatic Query**

Turns automatic query on/off.

▶ **Occurs Every**

In an automatic query, length of time between automatic updates.

▶ **Start Time**

In an automatic query, start time for the automatic update (displayed in 24 hour time).

▶ **Ping**

Tap to determine whether the IP address is accessible. The system displays OK or Failed.

MPPS

Required fields are marked with asterisks.

▶ **Name**

Network host name for the MPPS server.

▶ **Alias**

Name that identifies the network location of the MPPS system.

▶ **AE Title**

DICOM Application Entity Title.

▶ **IP Address**

Unique identifier of the MPPS server.

▶ **Port**

Device port number. IP port 104 is typically assigned for DICOM.

► Ping

Tap to determine whether the IP address is accessible. The system displays OK or Failed.

Associating devices with locations

For each location, select which devices (archivers and printers) you want to receive the data that you transfer, which archivers you want to designate as an MPPS or storage commitment server, and which worklist server you want to receive data from. Once these selections are complete, select the location you want to use.

Note

Changing the configuration requires a system restart.

To associate devices with a location

The devices must be configured before you can associate them. See [“To configure a new location or device”](#) on page 3-18.

- 1 Tap **MORE**, and then tap **System Settings**.
- 2 Tap **Connectivity** in the list on the left.
- 3 On the **Connectivity** setup page, tap **DICOM Setup**.
- 4 In the **Location** list, select the location of the system.
- 5 In the list of devices, check the box next to one or more archivers, printers, or worklist servers.
You can select a maximum of two printers, four archivers, and one worklist server for each location. Only one archiver can be selected to receive in-progress transfers. Selected devices have a check mark in the left-hand column.
- 6 If you want to use the MPPS service, associate the MPPS server with the archiver:
 - a Check the box of the MPPS server that you want. (MPPS servers appear near the end of the list.)
 - b Check the box of the archiver.
 - c Check the box in the archiver's MPPS column.
- 7 If you want to use the storage commitment service, associate the storage commitment server with the archiver:
 - a Check the box for the storage commitment server that you want. (Storage commitment servers appear at the end of the list.)
 - b Check the box for the archiver.
 - c Check the box in the archiver's SC column.
- 8 Complete any additional configuration tasks, and then tap **Done**.

To disassociate devices with a location

- 1 Tap **MORE**, and then tap **System Settings**.
- 2 Tap **Connectivity** in the list on the left.
- 3 On the **Connectivity** setup page, tap **DICOM Setup**.
- 4 In the **Location** list, select the location.
- 5 Do any of the following:
 - ▶ To disassociate a printer, archiver, or worklist server, select its check box.
 - ▶ To disassociate an MPPS server from an archiver, select the check box for the MPPS server.
 - ▶ To disassociate a storage commitment server from an archiver, select the check box for the storage commitment server.
 - ▶ To disassociate an archiver from all servers, deselect and then reselect its check box.
- 6 Tap **Done**.

To verify the connection status of devices

- 1 On the **Connectivity** setup page, tap **DICOM Setup**.
- 2 Tap **Verify** to confirm that the associated devices are connected. (If **Verify** is unavailable, check cable and wireless connections. Restart the system if you changed configuration. If the problem continues, see your system administrator.)

The connection status of the devices appears in the **Status** column:

- ▶ **Failed** DICOM cannot communicate with the device.
- ▶ **Success** DICOM can communicate with the device.
- ▶ **Unknown** The device does not support the C-ECHO (for example, Verify query command).

Date and Time settings

WARNING

To obtain accurate obstetrics calculations, an accurate date and time are critical. Verify that the date and time are accurate before each use of the system.

To display the Date and Time settings page

- 1 Tap **MORE**, and then tap **System Settings**.
- 2 Tap **Date and Time** in the list on the left.

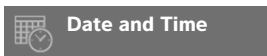

To set the date and time

- ❖ On the **Date and Time** settings page, do the following:
 - ▶ In the **Date** boxes, type the current year, month, and day.
 - ▶ In the **Time** boxes, type the current time in hours and minutes.
 - ▶ To obtain the system time from a time server, select **Use Time on Time Server** and enter the **Server Address**. These options are available only if the DICOM licensed feature is enabled on the system.

Note

If you select **Use Time on Time Server**, you cannot edit the **Date** and **Time**. If you want to edit the **Date** and **Time**, deselect **Use Time on Time Server** first.

- ▶ To specify that the system automatically adjusts for daylight savings time changes, select **Daylight Savings Time**. This option is available only if you select **Use Time on Time Server**.
- ▶ Select your time zone from the **Time Zone** list.

Display Information settings

On the **Display Information** settings page, you can specify which details appear on the clinical monitor during imaging.

To display the Display Information settings page

- 1 Tap **MORE**, and then tap **System Settings**.
- 2 Tap **Display Information** in the list on the left.



To specify details that appear on the clinical monitor

- ❖ On the **Display Information** settings page, select settings in the following sections:
 - ▶ **Patient Header** Information that appears in the patient header, including the **Patient Name**, **Patient ID**, **Department ID**, **User**, **Institution**, and **Date and Time**.
 - ▶ **Mode Data** Imaging information for **2D**, **Doppler**, **Color**, or **M Mode**.

Logs

On the **Logs** settings page, you can view the following logs:

- ▶ **User** Collects information about user logins and user creation, as well as information about when the log was exported or cleared.
- ▶ **DICOM** Collects network errors and events, typically to support diagnostics (see “**DICOM**” on page 3-14).
- ▶ **Assert** Collects processor exceptions and software-generated assertions to support diagnostics. The assert log is visible only to users with administrative privileges.
- ▶ **System** Collects errors and events to support diagnostics. The system log is visible only to users with administrative privileges.

The logs are text files that you can open in a text-editing application (for example, Notepad or TextEdit). You can export the logs to a USB memory stick and read them on a PC.

Log contents are saved as entries are generated. The logs have limited space and overwrite existing content when full.

To display the Logs settings page

- 1 Tap **MORE**, and then tap **System Settings**.
- 2 Tap **Logs** in the list on the left.



To export a log

Caution

To avoid losing data from or damaging the USB memory stick, do not remove the USB memory stick or turn off the ultrasound system while exporting. In addition, do not bump or apply pressure to the USB memory stick while it is connected to the system. The connector could break.

- 1 Connect a USB memory stick (see “**To connect a USB memory stick for importing or exporting**” on page 2-19).
- 2 On the **Logs** settings page, tap the log.
- 3 Tap **Export**.
A list of USB devices appears.
- 4 Select the appropriate USB memory stick, and tap **Export**.
- 5 Tap **Yes** to confirm the export.
Five seconds after the exporting completes, you can safely remove the USB memory stick.

To clear a log

- 1 On the **Logs** settings page, tap the log.
- 2 Tap **Clear** to delete all text.
- 3 Tap **Yes** to confirm the deletion.

Related topics

DICOM 3-14

Network Status settings

The **Network Status** settings page displays information on system IP address, location, subnet mask, default gateway, DNS address, wireless network SSID, connected BSSID, wireless MAC address, the Ethernet MAC address, as well as signal strength and connected status when connected to a wireless network.

To display the Network Status settings page

- 1 Tap **MORE**, and then tap **System Settings**.
- 2 Tap **Network Status** in the list on the left.



Related topics

Connectivity settings 3-12
DICOM 3-14

Power and Battery settings

On the **Power and Battery** settings page, you can specify the period of inactivity before the system goes into sleep mode or turns off.

To display the Power and Battery settings page

- 1 Tap **MORE**, and then tap **System Settings**.
- 2 Tap **Power and Battery** in the list on the left.

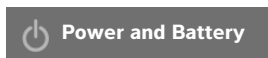

To specify power settings

❖ On the **Power and Battery** settings page, select from the following lists:

- ▶ **Sleep Delay** Select **Off**, or **5** or **10** minutes to specify the period of inactivity before the system goes into sleep mode.

The system will automatically turn off if it is in sleep mode and the battery charge level drops below 14%.

Note

The system will not sleep if you are in Procedure mode (see “**Controls in 2D**” on page 4-9) or if the system is archiving or exporting exams.

- ▶ **Power Delay** Select **Off**, or **15** or **30** minutes to specify the period of inactivity before the system automatically turns off.

Presets settings

The **Presets** settings page has settings for general preferences, brightness, labels, exam types, and user profile settings. You can export and import these settings.

To display the Presets settings page

- 1 Tap **MORE**, and then tap **System Settings**.
- 2 Tap **Presets** in the list on the left.



General preferences

To set general preferences

❖ On the **Presets** settings page, select from the following lists:

Note

Changing **Doppler Scale** or **Units** clears all measurements and calculations for the current exam.

- ▶ **Doppler Scale** Select **cm/s** or **kHz**.

Note

Some calculations are unavailable if the system is set to kHz.

- ▶ **Thermal Index** Select **TIS**, **TIB**, or **TIC**. The setting is retained for the current session. When the exam is ended or another transducer or exam type is selected, the exam type-based default setting is used.
- ▶ **Units** Units for patient height and weight in cardiac exams: **in/ft/lbs** or **cm/m/kg**.

- ▶ **Auto Save Patient Form** When this option is on, the system saves the patient form as an image in the patient's exam.
- ▶ **Generate Patient ID** When this option is on, the system automatically generates a unique patient ID upon starting an exam from the patient form, unless a patient ID is entered manually or from the worklist. This option can be used to accommodate certain workflows.
- ▶ **Prefix** Defines a prefix string attached to the beginning of the automatically generated patient ID. This enables you to easily search for the patient ID on the image storage system at a later time. This option is available only when the **Generate Patient ID** option is on.

Brightness

You can adjust the brightness of the clinical monitor or the touch panel to compensate for the level of light in the room in which the system is located.

To adjust brightness

- ❖ Do either or both of the following on the **Presets** settings page:
 - ▶ Drag the **Monitor Brightness** slider. The range is **0-10**.
 - ▶ Drag the **Touch Panel Brightness** slider. The range is **2-10**.

Labels

You can customize predefined labels, create new labels, delete labels, and set the preference for clearing labels when unfreezing images.

To manage predefined labels

Each exam type supports up to 35 predefined labels.

- 1 On the **Presets** settings page, tap **Labels**.
- 2 Tap an exam type and do any of the following:
 - ▶ To customize a label, tap it and edit the text in the text box at the top of the form. Tap **Apply**.
 - ▶ To create a new label, tap an empty label, and type the new label in the text box. Tap **Apply**.
 - ▶ To delete a label, tap the **X** next to the label.
 - ▶ To reset labels to the factory default, tap **Reset**.
 - ▶ To select a new exam type, tap **Exam Type**.

To specify label retention when unfreezing

You can specify that all labels be cleared from an image when you unfreeze the image.

- 1 On the **Presets** settings page, tap **Labels**.
- 2 Select **Clear Labels on Unfreeze**.

Exam types

The system displays both system-defined and user-defined exam types, organized by transducer.

You cannot share user-defined exam types among transducers.

To manage exam types

- 1 On the **Presets** settings page, tap **Exam Types**.
- 2 Tap the transducer that includes the exam type you want to manage.

Note

If the transducer that includes the exam type you want to manage does not appear, make sure that the transducer is connected to the system.

- 3 Do any of the following:
 - ▶ (User-defined exam types only) To rename the exam type, tap the exam type name and type a new name.
 - ▶ (User-defined exam types only) To delete the exam type, tap the delete icon.
 - ▶ To show or hide the exam type in the transducer & exam types list, tap the check box next to the exam type in the  column.
 - ▶ To rearrange the exam type, tap it and then tap **Up** or **Down**.
 - ▶ To return to the transducer and exam types list, tap **Transducer**.
- 4 Tap **Done**.

Customizing exam types

You can create a user-defined exam type by customizing any exam type to use your favorite settings. When you select the new exam type the system automatically uses the settings you specified.

The system displays user-defined exam types along with the original exam types in the transducer-selection lists.

You can define up to five custom exam types for each factory default exam type/ transducer combination. For example, you can customize five different exam types for Abdomen on the P21xp transducer and five different exam types for Abdomen on the C60xp transducer.

You can rename, delete, export, show, hide, reorder, and import user-defined exam types. See [“Presets settings”](#) on page 3-31.

To customize an exam type

- 1 Select a transducer and exam type (see “[Selecting a transducer and exam type](#)” on page 2-27).
- 2 Adjust imaging controls to your favorite settings.
You can set gain, AutoGain adjust, depth, dynamic range, image orientation, sweep speed, color settings, color Doppler type, Doppler invert, Doppler angle correct, wall filter level, scale, baseline, audio volume level, optimization, centerline display, and Doppler trace settings.
- 3 Tap **Save Exam Type**.
If this control is hidden, tapping **More Controls** displays it.
- 4 In the **Save User-Defined Exam** window, tap **New**.
- 5 Type a name for the exam type in the Exam box, and then tap **Save**. The exam type must have a unique name.

To modify a user-defined exam type

- 1 Adjust imaging controls to the new settings.
- 2 Tap **Save Exam Type**.
If this control is hidden, tapping **More Controls** displays it.
- 3 In the **Save User-Defined Exam** window, tap the exam type and tap **Update**.
The current settings overwrite the previously saved settings.

User profile settings

To specify a startup mode

You can specify what mode the system will be in when you start it, end an exam, or log in.

- 1 On the **Presets** settings page, tap **User Profile**.
- 2 Select an option in the **Startup** section:
 - ▶ **Start Select Screen** Displays the home screen, which offers you the option of scanning, entering patient information, select a transducer and exam type, or viewing visual guides.
 - ▶ **Scanning** Displays the 2D imaging screen.
 - ▶ **Transducer/Exam Select** Displays the options for selecting transducers and exam types.
 - ▶ **Patient Info** Displays the patient form.

To automatically query the worklist from a bar code scanner

WARNING

To avoid damage to the eye, do not look directly into the beam. The bar code scanner is a Class 2 laser product.

You can specify that the system query the worklist for patient information when you scan a patient ID bar code.

- 1 On the **Presets** settings page, tap **User Profile**.
- 2 Select **Bar Code Auto Query**.

To program the footswitch

You can specify the function of the left and right footswitches: **None**, **Save Video Clip**, **Record**, **Freeze**, **Save Image**, or **Print**.

- 1 On the Presets settings page, tap **User Profile**.
- 2 Select options from the **Footswitch (L)** and **Footswitch (R)** lists.

To configure custom controls

By default, the controls that appear next to the **Freeze** control in live imaging are **Print**, **Save Image**, **Save Video Clip**, and **End Exam**. The **Auto** gain control  appears just above **End Exam**.

You can specify the function of these controls.

- 1 On the Presets settings page, tap **User Profile**.
- 2 Select options from the **Program Control A**, **Program Control B**, **Program Control C**, and **Program Control D** lists.

The selected options for **Program Control A** and **Program Control B** appear to the left of the Freeze control on the touch panel. The selected options for **Program Control C** and **Program Control D** appear to the right of the Freeze control on the touch panel.

To reset controls

You can reset the More Controls window to the factory default.

If you have moved controls from the More Controls window to the Controls bar, resetting the controls removes them from the Controls bar. Similarly, resetting the controls moves controls you have moved from the Controls bar to the More Controls window.

- 1 On the Presets settings page, tap **User Profile**.

2 Tap **Reset More Controls**.

To show or hide the Learn button

You can specify that the system hide the Learn button on the touch panel. If you hide the Learn button, you can still access the visual guides by selecting **Learn** from the **More** menu.

1 On the Presets settings page, tap **User Profile**.

2 Deselect **Show Learn Button**.

Importing and exporting

When you import or export from the **Presets** settings page, you import and export all labels, exam types, user accounts, and system settings, except for connectivity settings.

Note

You must have administrative privileges to import or export labels, exam types, user accounts, and system settings.

To import or export

When you import from the **Presets** settings page, all system preferences on the system are replaced with the imported preferences. When you export from the **Presets** settings page, all system preferences on the USB memory stick are replaced with the exported preferences.

1 Insert a USB memory stick.

2 On the **Presets** settings page, do either of the following:

- ▶ To import labels, exam types, user accounts, and system settings, tap **Import**, and then tap **Yes**.

Select the desired USB memory stick, and then tap **Import**.

All labels, exam types, user accounts, and system settings are replaced with those from the USB memory stick.

- ▶ To export labels, exam types, user accounts, and system settings, tap **Export**, and then tap **Yes**.

Select the desired USB memory stick, and then tap **Export**.

A copy of all labels, exam types, user accounts, and system settings saves to the USB memory stick. Passwords for user accounts are encrypted.

Routing selections

Routing selections let you control where patient exams are archived. You can associate one or more routing selections with an exam.

The system supports three routing selections:

- ▶ Diagnostics
- ▶ Educational/Accreditation
- ▶ Procedural

You can associate the Educational/Accreditation routing selection with a DICOM archive device (see [“Specifying educational DICOM archivers”](#) on page 3-38).

Related topics

DICOM 3-14

Associating routing selections with exams

When you associate one or more routing selections with an exam, the system reflects the routing selections in the patient report and in the Acute Care worksheet (if the Acute Care Worksheets licensed option is installed). See [“Worksheets and reports”](#) on page 5-50.

You can associate an exam with a routing selection during an exam or after ending an exam.

Note

If you specify an archiver as an educational archiver (see [“To specify an educational archiver”](#) on page 3-38), exams that aren't associated with a routing selection will not transfer to any archiver. To associate an exam with a routing selection once the exam has ended, see [“To associate a routing selection after an exam.”](#)

To associate a routing selection during an exam

- 1 Tap **PATIENT**.
- 2 Select one or more routing selections in the **Routing Selection** section of the patient form.

To associate a routing selection after an exam

When you change the routing selection after an exam has ended, the system updates the patient report.

- 1 Tap **REVIEW**.
- 2 Tap **Patient List**.
- 3 Select the check box next to the exam, and then tap **Route Exam**.
- 4 Select one or more options in the **Routing Selection** section.

Specifying educational DICOM archivers

When you associate the Educational/Accreditation routing selection with a DICOM archiver, the system archives exams associated with the Educational/Accreditation routing selection to that archiver.

Archivers that are not specified as educational are *procedural* (billing) archivers. The system archives exams associated with the Diagnostic and Procedural routing selections to these archivers.

If you do not specify an archiver as an educational archiver, exams associated with the Educational/Accreditation routing selection are also sent to the procedural (billing) archiver.

If an exam is associated with more than one routing selection, the system archives it to both the procedural (billing) archiver and to the educational archiver.

To specify an educational archiver

Note

If you specify an archiver as an educational archiver, exams that aren't associated with a routing selection will not transfer to any archiver. To associate an exam with a routing selection once the exam has ended, see ["To associate a routing selection after an exam"](#) on page 3-37.

- 1 Make sure that the system is configured for DICOM transfer. See ["DICOM"](#) on page 3-14.
Tap **MORE**, and then tap **System Settings**.
- 2 Tap **Connectivity**.
- 3 On the **Connectivity** system setup page, tap **DICOM Setup**.
- 4 Tap **Config**.
- 5 From the **DICOM** list, select the **Archive** configuration page for the archiver.
- 6 Select **Educational**.
- 7 Tap **Done**.

System Information settings

The **System Information** settings page displays system hardware and software versions, patents, and license information.

See also ["Software licensing"](#) on page 7-3.

To display the System Information settings page

- 1 Tap **MORE**, and then tap **System Settings**.

2 Tap **System Information** in the list on the left.

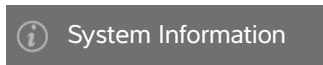

USB settings

On the USB settings page, you can view information about connected USB devices, including space availability.

You can also specify a file format and options for images and video clips in patient exams that you export to a USB memory stick, and you can enable automatic export of ended exams.

To display the USB settings page

- 1 Tap **MORE**, and then tap **System Settings**.
- 2 Tap **USB** in the list on the left.



To specify export options

- 1 On the **USB** settings page, select an **Export Type**:
 - ▶ **DICOM Export** creates DICOMDIR files readable by a DICOM reader. DICOM is an optional feature.
 - ▶ **Multimedia Export** organizes files in a standard folder structure. Video clips export in MJPEG video saved as AVI. To view them, FUJIFILM SonoSite recommends Windows Media Player or QuickTime 7.0 or later.
- 2 Select an **Image Format** for your export type. For JPEG image format, also select a JPEG compression. A high compression has a smaller file size but less detail (see [“Limitations of JPEG format”](#) on page 3-40). The image format affects both still images and video clips.

For optimal DICOM image quality, select RGB image format and low compression.
- 3 (**Multimedia Export** only) Select a sort order from the **Sort By** list.
- 4 Select **Auto Export** to enable automatic export of ended exams. See also [“To export patient exams automatically to a USB memory stick”](#) on page 4-46.
- 5 (**DICOM Export** only) Select any of the following:
 - ▶ **Include CDA** to export the CDA report. See [“CDA Report settings”](#) on page 3-11.
 - ▶ **Include SR** to export the Structured Report.
- 6 Tap **Done**.

Limitations of JPEG format

When transferring or exporting images in JPEG format, the system uses *lossy compression*. Lossy compression may create images that have less absolute detail than BMP format, and do not render identically to the original images.

JPEG settings:

<u>Setting</u>	<u>Quality Level</u>
Low	100%; The difference between the compressed and uncompressed image is near 0.
Medium	90%; Generally loss only to high frequency content (some degradation occurs at the edges of structures in the image).
High	75%; General loss of detail

Note

The ratio of the image size without compression to the image size with compression is dependent on the content of the image

In some circumstances, lossy-compressed images may be inappropriate for clinical use.

For more information on using lossy-compressed images, consult the industry literature.

Imaging

This section describes imaging with the SonoSite X-Porte ultrasound system.

Imaging modes

Imaging modes available on SonoSite X-Porte are:

- ▶ 2D (see **"2D"** on page 4-2)
- ▶ Color, (see **"Color"** on page 4-3)
- ▶ Doppler (see **"Doppler"** on page 4-4)
- ▶ M Mode (see **"M Mode"** on page 4-2)
- ▶ Dual (see **"Dual"** on page 4-5).
- ▶ Simultaneous Doppler (see **"Simultaneous Doppler"** on page 4-7).

For information about working with controls, see **"Imaging controls"** on page 4-8.

Note

When you change display formats (for example, from a single image to Dual, or by changing the Display Format), the images may overlap. If the M line or D line is located near the side of the image, it may be hidden. Toggle the trace to expose the M line or D line.

For a list of imaging modes available by transducer and exam type, see **"Selecting a transducer and exam type"** on page 2-27.

Related topics

Doppler	4-4
Color	4-3
M Mode	4-2
2D	4-2
Dual	4-5

Imaging controls	4-8
Controls in 2D	4-9
Controls in M Mode	4-14
Controls in Color	4-16
Controls in Doppler	4-18

2D

2D is the system's default imaging mode. The system displays echoes in two-dimensional view by assigning a brightness level based on the echo signal amplitude. To achieve the best possible image quality, properly adjust the gain, depth settings, viewing angle, exam type, and display brightness. Also, select an optimization setting that best matches your needs.

To scan in 2D

- 1 Do one of the following:
 - ▶ Tap **2D**.
 - ▶ In Transducers & Exams, tap **SCAN**.
- 2 Adjust controls as needed. See **"Controls in 2D"** on page 4-9.

Related topics

Controls in 2D	4-9
----------------------	-----

M Mode

Motion mode (M Mode) is an extension of 2D. It provides a trace of the 2D image displayed over time. A single beam of ultrasound is transmitted, and reflected signals are displayed as dots of varying intensities, creating lines across the screen.

To scan in M Mode

- 1 Tap **M Mode**.

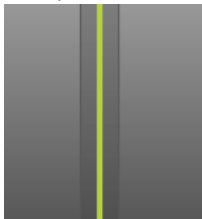

The M-line appears.

- 2 Drag the M-line to the desired position.

3 To display the M Mode sweep, do the following:

a Adjust the depth as needed. See [“Adjusting depth and gain”](#) on page 4-22.

b Tap **Start** or **Update**.

If **Update** is hidden, tapping **More Controls** displays it.

c Do any of the following:

▶ Tap **Stop** and **Start** to stop and start the M Mode sweep.

▶ Tap **Sweep Speed** and then tap a sweep speed: **Fast**, **Medium**, or **Slow**.

If this control is hidden, tapping **More Controls** displays it.

▶ The M Mode sweep and 2D image are active until frozen. Tap **Update** to toggle display of 2D and M Mode controls and calculations.

4 Adjust controls as needed. See [“Controls in Doppler”](#) on page 4-18.

Related topics

Controls in Doppler 4-18

Color

Color imaging shows the presence, velocity, and direction of blood flow toward and away from the transducer. In Color mode, the area within the highlighted box displays blood flow in color.

To scan in Color

1 Tap **Color**.

The color box appears.

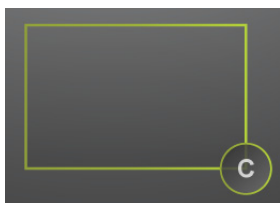

2 Position and resize the color box as needed:

▶ To position, drag the box.

▶ To resize, do either of the following:

▶ Pinch or spread the box.

▶ Drag its handle .

A green outline shows that the status of the change is active. On the clinical monitor, the current outline remains in gray until you stop moving or release your finger.

- ▶ To steer (linear transducers only), do either of the following:
 - ▶ Swipe left or right.
 - ▶ Tap **Steering** and select an angle.

3 Adjust controls as needed. See “**Controls in Color**” on page 4-16.

Related topics

Controls in Color 4-16

Doppler

Doppler imaging is a display of a spectrum of flow velocities over time. The amplitude of the signal is indicated as a shade of gray. Doppler imaging can be used to display any type of movement, including blood flow and tissue movement. Pulsed wave (PW), pulsed wave Tissue Doppler Imaging (PW TDI), and continuous wave (CW) Doppler are available. CW Doppler is not range specific.

To scan in Doppler

1 Tap **Doppler**.

The D-line appears

2 Do any of the following as needed:

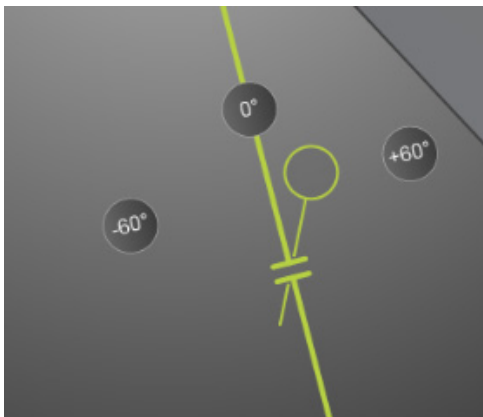

- ▶ Position the D-line by dragging the line left or right.
- ▶ Adjust the gate size using any of the following methods
 - ▶ Pinch or expand the gate with your fingers.
 - ▶ Tap **Gate Size**.

If this control is hidden, tapping **More Controls** displays it.

3 Adjust the angle using any of the following methods:

- ▶ Drag the angle cursor to the correct angle.
- ▶ Tap one of the preset angles on the screen: **+60°**, **0°**, or **-60°**.
- ▶ Tap **Angle Correct**.

If this control is hidden, tapping **More Controls** displays it.

4 In the Cardiac exam type only, select one of the following modes:

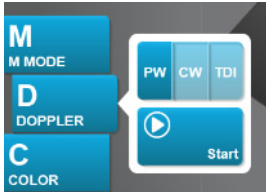

- ▶ **PW** - Pulsed wave Doppler
- ▶ **CW** - Continuous wave Doppler
- ▶ **TDI** - Tissue Doppler Imaging

5 Tap **Start** or **Update**.

The spectral trace appears.

6 To make further adjustments, tap either the 2D image or the spectral trace to activate them, or tap **Update** to toggle between them.

Related topics

Controls in Doppler 4-18

Dual

Dual displays side-by-side 2D and Color images. The system supports independent image information for each dual side, for example, depth, and orientation markers. You can switch between the two images and adjust some controls (for example, depth, mode, and gain) independently. You can view frames in the cine buffer for both dual sides independently.

To scan in Dual

1 Tap **Dual**. When **Dual** is on, the control is highlighted.



If this control is hidden, tapping **More Controls** displays it.

2 Do either of the following to make an image active:

- ▶ Tap the right-hand or left-hand image.
- ▶ Tap **Update** to switch between the right-hand and left-hand images.

If this control is hidden, tapping **More Controls** displays it.

When you transition to live imaging, the settings are those of the last imaging state.

3 Adjust controls as needed. See “**Controls in 2D**” on page 4-9 and “**Controls in Color**” on page 4-16.

Tap **Dual** again to turn it off.

To view frames in the cine buffer in Dual

You can view independent cine buffers for side-by-side images in Dual.

1 Tap **Dual**. When **Dual** is on, the control is highlighted.



2 Do either of the following to make an image active:

- ▶ Tap the right-hand or left-hand image.
- ▶ Tap **Update** to switch between the right-hand and left-hand images.

If this control is hidden, tapping **More Controls** displays it.

3 Tap **FREEZE**.

4 Do any of the following:

- ▶ Drag the slider. Right moves forward, and left moves backward.
- ▶ Tap  or  to move forward or backward through frames one at a time.

The current frame number appears on the touch panel. The frame number changes as you move forward or backward.

- ▶ Tap the right-hand or left-hand image, or tap **Update** to switch between the right-hand and left-hand images.

Related topics

2D	4-2
Color	4-3
Controls in 2D	4-9
Controls in Color	4-16

Simultaneous Doppler

Simultaneous Doppler imaging assesses body structures simultaneously in two modes: 2D and PW Doppler, or three modes: 2D, Color, and PW Doppler. See [Table 2-1, “Imaging modes and exam types on transducers”](#) on page 24 for compatible exam types and transducers.

WARNING

The PW Doppler sensitivity and waveform appearance in simultaneous Doppler may be inferior to that in non-simultaneous (update) Doppler imaging modes. You can turn off simultaneous imaging to confirm Doppler waveform characteristics.

To scan in simultaneous Doppler

- 1 Tap **Doppler** to begin Doppler imaging.
- 2 Position and adjust the D-line and gate.
- 3 Tap **Start** or **Update** to display the spectral trace.

Note

Tapping **Update** toggles the display of 2D, Color, and Doppler controls and calculations.

- 4 Tap **Simultaneous**. When **Simultaneous** is available, the control is highlighted.



If this control is hidden, tapping **More Controls** displays it.

Note

The **Simultaneous** control can only be found in the Doppler controls.

- 5 Tap **More Controls** to display and adjust specific controls for each of the three modes.



Note

Full screen display is unavailable in simultaneous Doppler mode.

To view frames in the cine buffer in simultaneous Doppler

- 1 Freeze the image.
- 2 Do either of the following:
 - ▶ Drag the slider. Right moves forward, and left moves backward.

While the slider bar represents the complete set of collected imaging data, the scrolling display shows only one cycle of imaging data at a time. The green CINE marker (▲) indicates a single column on the scrolling display, which corresponds in time to the displayed image.

- ▶ Tap  or  to move forward or backward through frames one at a time.

Tapping these controls moves the green CINE marker (▲), showing a column on the scrolling display and its corresponding image.

Note

You can customize an exam type to display the **Simultaneous** control button by default. See “**Customizing exam types**” on page 3-33.

Related topics

2D	4-2
Color	4-3
Controls in 2D	4-9
Controls in Color	4-16
Doppler	4-4
Controls in Doppler	4-18

Imaging controls

The imaging controls let you adjust the image and related parameters, label, zoom, and more.

For each imaging mode, you can place your favorite and most-used controls in the Controls bar, located on the right side of the touch panel. You can place controls for the frozen image as well as for the live image. The remaining controls are still accessible in the **More Controls** window.

Available controls depend on the imaging mode, system configuration, and whether the image is live or frozen.

To access a control in the More Controls window

- 1 Tap **More Controls**.
- 2 If necessary, tap the imaging mode (for example, **2D**) at the top of the **More Controls** window. (The control for the active imaging mode is blue.)



Multiple imaging modes are available if one of them includes another. For example, because 2D is a subset of M Mode, you can choose from both 2D and M Mode controls when scanning in M Mode.

- 3 Tap the control.
- 4 If necessary, close the control: tap the X in the upper left corner of the control, or tap anywhere in the **More Controls** window.

To close the **More Controls** window, tap **More Controls**, or tap anywhere outside the **More Controls** window.

To place controls in the Controls bar

- 1 Start the imaging mode whose controls you want to place.
- 2 If placing controls for frozen imaging, freeze the image (see [“To freeze the image”](#) on page 4-24).
- 3 Tap **More Controls**.
The **More Controls** window appears.
- 4 Do the following for each imaging mode available:
 - ▶ At the top of the window, tap the imaging mode (for example, **2D**).
 - ▶ Drag each control to the Controls bar, into the desired position.

You can drag the control up or down to another position, or you can drag it back into the **More Controls** window.

You can place up to seven controls in the Controls bar.
- 5 To close the **More Controls** window, tap **More Controls**, or tap anywhere outside the **More Controls** window.

Related topics

Controls in 2D	4-9
Controls in M Mode	4-14
Controls in Color	4-16
Controls in Doppler	4-18

Controls in 2D

To specify which controls appear in the Controls bar, see [“Imaging controls”](#) on page 4-8. Some controls appear only when the image is frozen.

Table 4-1: 2D controls

Button name	Description	Available in	
		Live	Frozen
THI	Tap this control to turn Tissue Harmonic Imaging (THI) on (highlighted icon) or off (dimmed icon). Available only with certain transducers and exam types.	✓	
LVO	Tap left ventricular opacification (LVO) to lower the mechanical index (MI) of the system. MI has been lowered to a fixed 0.2. Available only if THI is turned on.	✓	

Table 4-1: 2D controls (continued)

Button name	Description	Available in	
		Live	Frozen
SonoMB	Turns SonoMB multi-beam imaging technology on (highlighted icon) and off (dimmed icon). SonoMB enhances the 2D image by viewing a target from multiple angles and then merging or averaging the data. Available only with certain transducers and exam types.	✓	
Update	Updates the image. In Dual, tapping the control switches the active side from left to right or right to left. In Doppler or M Mode, tapping the control toggles between the trace or sweep and the 2D pane.	✓	✓
Needle Profiling	Tap on (highlighted icon) to enhance linear structures within a selected angle range and facilitate needle guidance. See “Visualizing needles” on page 4-26.	✓	
Orientation	Tap to select the image orientation and align the image with the transducer: Upper Right, Upper Left, Lower Left, Lower Right .	✓	
Res/Gen/Pen	Settings are as follows: <ul style="list-style-type: none"> ▶ Res provides the best possible resolution. ▶ Gen provides a balance between resolution and penetration. ▶ Pen provides the best possible penetration. Optimizes the image by applying a specific group of settings such as focal zones, aperture size, frequency (center and bandwidth), line density, and waveform. The appearance and number of optimization settings for this button are determined by the selected transducer and exam type.	✓	
Dual	Tap this control on (highlighted icon) to display side-by-side images, for which you can adjust some controls (for example, Depth and Gain) independently. With Dual on, tapping the right-hand or left-hand image (or tapping Update) makes the image active. See “Dual” on page 4-5.	✓	✓
Autogain Adjust	AutoGain control: adjusting to the positive side brightens images when you tap AutoGain , adjusting to the negative side makes images darker when you tap AutoGain . Tap AutoGain to make the control available (see “Gain” on page 4-23). Tap this control and then drag the slider (the range is -6 to +6) or tap +3, 0 , or -3 . The AutoGain Adjust control is disabled when you perform any action that turns off AutoGain , such as changing depth.	✓	

Table 4-1: 2D controls (continued)

Button name	Description	Available in	
		Live	Frozen
Sector	Specifies the sector width. Tap this control and then tap Narrow , Medium , or Full . Steer reduced size sectors left or right by dragging from anywhere within the sector. Available only in the Cardiac exam type for certain transducers.	✓	
Video Clip Settings	See “Saving video clips” on page 4-47.	✓	✓
Needle Guide	Turns needle guidelines on and off. For more information, including a list of transducers that are needle-guide capable and important safety information, see the transducer's user guide and <i>Using CIVCO Products with FUJIFILM SonoSite Systems</i> . Only compatible with Full sector.	✓	
ECG	Tap this control to display ECG settings. ECG is available only on the cardiac exam type. See “ECG” on page 4-52.	✓	
Procedure Mode	Tap this control to turn it on (highlighted icon) or off (dimmed icon). Allows you to view the image uninterrupted; for example, during a needle insertion procedure. When this control is enabled, the following are disabled: <ul style="list-style-type: none"> ▶ Dialog boxes or other system elements that block the image ▶ Sleep mode and automatic power-off 	✓	
Dyn. Range	Adjusts the grayscale range. Tap the control and then tap Up or Down to select a setting: -3,-2,-1, 0, +1,+2,or +3. The selected setting is applied to both 2D and M Mode. The positive range increases the number of grays displayed, and the negative range decreases the number of grays displayed.	✓	✓
Save Exam Type	See “Customizing exam types” on page 3-33.	✓	✓
Target Depth	Measures the distance from the skin line to a specified point on the image. For instructions, see “Measuring” on page 5-1.	✓	✓
Label	Provides tools that let you place text, pictographs, and arrows onto an image. See “Labeling images” on page 4-30.	✓	✓
Zoom	Magnifies the image. See “Zooming in on the image” on page 4-25.	✓	✓

Table 4-1: 2D controls (continued)

Button name	Description	Available in	
		Live	Frozen
Centerline	Turns the centerline graphic on or off. See “Related topics” on page 4-14. Centerline is available only with certain transducers and is not available in zoom mode or when Needle Guide is on.	✓	
Distance	Measures the distance between two points. See “Measuring” on page 5-1.		✓
Ellipse	Uses an ellipse to measure a region's circumference or area. See “Measuring” on page 5-1.		✓
Trace	Lets you trace manually to measure an irregular shape. See “Measuring” on page 5-1.		✓
Calcs	See “About calculations” on page 5-8.		✓
Acute Care	The Acute Care calculations are part of the licensed Acute Care feature. See “Acute Care calculations” on page 5-44.		✓

Centerline

The centerline graphic aligns with the center mark of the transducer and serves as a reference mark for the center of the displayed image.

When using the Centerline feature as a reference during a freehand procedure, be aware that the centerline represents only the center of the ultrasound image and is not an accurate predictor of the path the needle will take.

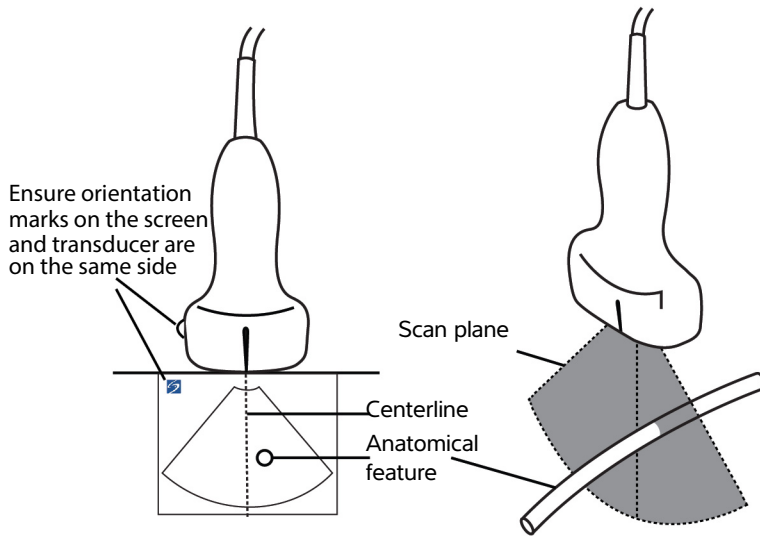

Figure 4-1 Relationship of the centerline graphic to the transducer and the ultrasound image.

Small tilts or rotations of the transducer can affect the relationship between any external reference points and the anatomy that appears on the ultrasound image.

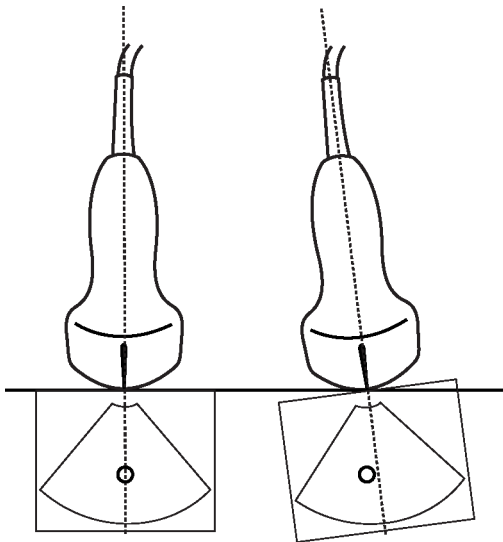

Figure 4-2 Relationship of the ultrasound image to the transducer angle or tilt.

Related topics

Imaging modes	4-1
Imaging controls	4-8
Controls in M Mode	4-14
Controls in Color	4-16
Controls in Doppler	4-18

Controls in M Mode

In M Mode imaging, you can adjust the following controls in addition to most of the 2D controls (see [“Controls in 2D”](#) on page 4-9). To specify which controls appear in the Controls bar, see [“Imaging controls”](#) on page 4-8. Some controls appear only when the image is frozen.

Table 4-2: M Mode controls

Button name	Description	Available in	
		Live	Frozen
Dyn. Range	Adjusts the grayscale range. Tap the control and then tap Up or Down to select a setting: -3,-2,-1, 0, +1,+2, or +3. The selected setting is applied to both 2D and M Mode. The positive range increases the number of grays displayed, and the negative range decreases the number of grays displayed.	✓	✓
ECG	Tap this control to display ECG settings. ECG is available only on the cardiac exam type. See “ECG” on page 4-52.	✓	
Save Exam Type	See “Customizing exam types” on page 3-33.	✓	✓
Sweep Speed	Available when displaying the M Mode sweep. Sets the sweep speed. Tap this control and then select the speed: Slow , Med , or Fast .	✓	

Table 4-2: M Mode controls (continued)

Button name	Description	Available in	
		Live	Frozen
Display Format	<p>Lets you control the format of the 2D and sweeping images. Tap this control, and then tap the specified format:</p> <ul style="list-style-type: none"> ▶ 1/3 2D, 2/3 Sweep ▶ 1/2 2D, 1/2 Sweep ▶ 2/3 2D, 1/3 Sweep ▶ Side by Side <p>You can adjust the images independently of each other. To make an image active, tap it, or tap Update.</p>	✓	✓
Label	Provides tools that let you place text, pictographs, and arrows onto an image. See "Labeling images" on page 4-30.	✓	✓
Update	Tap to toggle display of 2D and M Mode controls and calculations.	✓	✓
Distance Time	Available when displaying the M Mode sweep. Provides calipers to measure distance in centimeters and measure time in seconds. See "Basic measurements in M Mode" on page 5-3.		✓
Heart Rate	Available when displaying the M Mode sweep. Provides calipers to measure heart rate. See "Basic measurements in M Mode" on page 5-3.		✓

Related topics

M Mode	4-2
Imaging controls	4-8
Controls in 2D	4-9
Controls in Color	4-16
Controls in Doppler	4-18

Controls in Color

To specify which controls appear in the Controls bar, see “[Imaging controls](#)” on page 4-8. Some controls appear only when the image is frozen.

Table 4-3: Color controls

Button name	Description	Available in	
		Live	Frozen
Color	Allows you to select Color , Color Power Doppler (CPD), or Variance . On the P21xp transducer in the Cardiac exam type, Variance is available instead of CPD . CPD shows amplitude and is useful for very low flow states. Variance displays a color map that shows regurgitant jet turbulence. The highest velocities appear as green.	✓	
Flow State	Lets you adjust the sensitivity of color parameters or settings to enhance the flow state. The system initially selects a setting based on the exam type. <ul style="list-style-type: none"> ▶ High optimizes for high flow states such as cardiac. The High setting minimizes flash artifacts. ▶ Medium optimizes for medium flow states such as abdominal or arterial flow. ▶ Low optimizes for low flow states such as breast or musculoskeletal. For a more precise setting, adjust the Scale control.	✓	
Scale	Sets the pulse repetition frequency (PRF). Tap this control, and then tap Up or Down .	✓	
Wall Filter	Helps to filter out echoes from low frequency signals. Tap to select the strength of the filter: Low , Med , or High .	✓	
Steering	(Linear transducers only) Determines the angle of the color box (see “ Imaging controls ” on page 4-8), saving work in repositioning the transducer. If adding Doppler, see “ Controls in Doppler ” on page 4-18.	✓	

Table 4-3: Color controls (continued)

Button name	Description	Available in	
		Live	Frozen
Dual	Tap this control on (highlighted icon) to display side-by-side images, for which you can adjust some controls (for example, Depth and Gain) independently. With Dual on, tapping the right-hand or left-hand image (or tapping Update) makes the image active. See “Dual” on page 4-5.	✓	✓
Invert	Tap on (highlighted icon) to switch the displayed direction of the flow, which helps to reduce the need to reposition the transducer. Invert is unavailable when Color is set to CPD .	✓	✓
Hide Color/ Show Color	Shows and hides color.	✓	✓
Zoom	Magnifies the image. See “Zooming in on the image” on page 4-25.	✓	✓
Save Exam Type	See “Customizing exam types” on page 3-33.	✓	✓
Video Clip Settings	See “Saving video clips” on page 4-47.	✓	
Target Depth	Measures the distance from the skin line to a specified point on the image. For instructions, see “Measuring” on page 5-1.	✓	✓
Label	Provides tools that let you place text, pictographs, and arrows onto an image. See “Labeling images” on page 4-30.	✓	✓
Distance	Measures the distance between two points. See “Measuring” on page 5-1.		✓
Ellipse	Uses an ellipse to measure a region's circumference or area. See “Measuring” on page 5-1.		✓
Trace	Lets you trace manually to measure an irregular shape. See “Measuring” on page 5-1.		✓
Calcs	See “About calculations” on page 5-8.		✓
Acute Care	The Acute Care calculations are part of the licensed Acute Care feature. See “Acute Care calculations” on page 5-44.		✓

Related topics

Color	4-3
Imaging controls	4-8
Controls in 2D	4-9
Controls in M Mode	4-14
Controls in Doppler	4-18

Controls in Doppler

In Doppler imaging, you can adjust controls in D-line (see [Table 4-4](#) on page 4-18) and in scrolling Doppler (see [Table 4-5](#) on page 4-20). To specify which controls appear in the Controls bar, see [“Imaging controls”](#) on page 4-8. Some controls appear only when the image is frozen.

Table 4-4: Controls in D-line

Button name	Description	Available in	
		Live	Frozen
PW/CW/TDI	Select PW (pulsed wave Doppler), CW (continuous wave Doppler), or TDI (Tissue Doppler Imaging). CW and TDI are available only in the Cardiac exam type.	✓	
Steering	Linear transducers only. Determines the angle of the D-line.	✓	
Angle Correct	Available only in PW Doppler. Corrects the angle. Tap this control, and then drag the slider or select a setting: 0° , +60° , or -60° . You can also adjust the angle by tapping the double-headed arrows on the D-line.	✓	✓
Gate Size	Tap Up to increase the gate size. Tap Down to decrease the gate size. You may also pinch or expand the gate with your fingers.	✓	
Zoom	Magnifies the image. See “Zooming in on the image” on page 4-25.	✓	✓
Save Exam Type	See “Customizing exam types” on page 3-33.	✓	✓
Video Clip Settings	See “Saving video clips” on page 4-47.	✓	

Table 4-4: Controls in D-line (continued)

Button name	Description	Available in	
		Live	Frozen
Display Format	<p>Lets you control the format of the 2D and sweeping images. Tap this control, and then tap the specified format:</p> <ul style="list-style-type: none"> ▶ 1/3 2D, 2/3 Sweep ▶ 1/2 2D, 1/2 Sweep ▶ 2/3 2D, 1/3 Sweep ▶ Side by Side ▶ Full 2D, Full Sweep <p>You can adjust the images independently of each other. To make an image active, tap it, or tap Update.</p>	✓	✓
Update	<p>Updates the image. In Dual, tapping the control switches the active side from left to right or right to left. In Doppler or M Mode, tapping the control toggles between the Doppler/M Mode view and the 2D pane.</p>	✓	✓
Target Depth	<p>Measures the distance from the skin line to a specified point on the image. For instructions, see “Measuring” on page 5-1.</p>	✓	✓
Label	<p>Provides tools that let you place text, pictographs, and arrows onto an image. See “Labeling images” on page 4-30.</p>	✓	✓
Distance	<p>Measures the distance between two points. See “Measuring” on page 5-1.</p>		✓
Ellipse	<p>Uses an ellipse to measure a region's circumference or area. See “Measuring” on page 5-1.</p>		✓
Trace	<p>Lets you trace manually to measure an irregular shape. See “Measuring” on page 5-1.</p>		✓
Calcs	<p>See “About calculations” on page 5-8.</p>		✓
Acute Care	<p>The Acute Care calculations are part of the licensed Acute Care feature. See “Acute Care calculations” on page 5-44.</p>		✓

Table 4-5: Controls in scrolling Doppler

Button name	Description	Available in	
		Live	Frozen
PW/CW/TDI	Select PW (pulsed wave Doppler), CW (continuous wave Doppler), or TDI (Tissue Doppler Imaging). CW and TDI are available only in the Cardiac exam type.	✓	
Steering	Linear transducers only. Determines the angle of the D-line.	✓	
Scale	Sets the pulse repetition frequency (PRF). Tap this control, and then tap Up or Down .	✓	
Volume	Adjusts the Doppler speaker volume. Tap this control, and then tap Up to increase the volume or Down to decrease the volume.	✓	
Gate Size	Tap Up to increase the gate size. Tap Down to decrease the gate size. You may also pinch or expand the gate with your fingers.	✓	
Wall Filter	Helps to filter out echoes from low frequency signals. Tap to select the strength of the filter: Low , Med , or High .	✓	
Sweep Speed	Sets the sweep speed. Tap this control and then select the speed: Slow , Med , or Fast .	✓	
Update	Updates the image. In Dual, tapping the control switches the active side from left to right or right to left. In Doppler or M Mode, tapping the control toggles between the trace and the 2D pane.	✓	✓
Display Format	Lets you control the format of the 2D and sweeping images. Tap this control, and then tap the specified format: <ul style="list-style-type: none"> ▶ 1/3 2D, 2/3 Sweep ▶ 1/2 2D, 1/2 Sweep ▶ 2/3 2D, 1/3 Sweep ▶ Side by Side ▶ Full 2D, Full Sweep <p>You can adjust the images independently of each other. To make an image active, tap it, or tap Update.</p>	✓	✓

Table 4-5: Controls in scrolling Doppler (continued)

Button name	Description	Available in	
		Live	Frozen
Baseline	Sets the baseline position. Tap this control, and then tap Up or Down .	✓	✓
Invert	Tap on (highlighted icon) to switch the displayed direction of the flow, which helps to reduce the need to reposition the transducer.	✓	✓
Angle Correct	Corrects the angle. Tap this control, and then drag the slider or select a setting: 0° , +60° , or -60° . You can also adjust the angle by tapping the double-headed arrows on the D-line.	✓	✓
Auto Trace	Specifies the Doppler trace setting for measurements. Tap this control, and then tap Off , Peak (time average peak), or Mean (time average mean). After you tap Peak or Mean in live imaging, you can choose between Above , Below , or All to control the display relative to the baseline. While Peak and Mean are available both during live imaging and when the image is frozen, the settings Above , Below , and All are available during live imaging only.	✓	✓
ECG	Tap this control to display ECG settings. ECG is available only on the cardiac exam type. See “ ECG ” on page 4-52.	✓	
Save Exam Type	See “ Customizing exam types ” on page 3-33.	✓	✓
Label	Provides tools that let you place text, pictographs, and arrows onto an image. See “ Labeling images ” on page 4-30.	✓	✓
Velocity	Displays velocity measurements. See “ Basic measurements in Doppler ” on page 5-4.		✓
Time	See “ To measure time duration ” on page 5-5.		✓
Manual Trace	Lets you trace manually to measure an irregular shape. See “ Measuring ” on page 5-1.		✓
Auto Measure	See “ To measure automatically ” on page 5-7.		✓

Table 4-5: Controls in scrolling Doppler (continued)

Button name	Description	Available in	
		Live	Frozen
Calcs	See “About calculations” on page 5-8.		✓
Heart Rate	Provides calipers to measure heart rate.		✓
Slope	Provides calipers to measure slope and slope-related measurements. Only available in the cardiac exam type.		✓

Related topics

Doppler 4-4

Imaging controls 4-8

Controls in 2D 4-9

Controls in M Mode 4-14

Controls in Color 4-16

Adjusting depth and gain

Depth

Depth refers to the depth of display. You can adjust the depth in all imaging modes except M Mode sweep and Doppler trace. The vertical depth scale on the touch panel lists all available depth levels for the current transducer. The intervals depend on the active transducer.

To adjust the depth

As you adjust the depth, the depth value appears in a rectangle in the lower right corner of the image area or upper right corner if the image orientation is upside down.

Note

The depth value in the lower right corner of the clinical monitor is always the total acquired depth of the unzoomed image. When you zoom, this value stays the same.

❖ Do either of the following on the touch panel:

- ▶ Tap a marker on the depth scale.

- ▶ Drag the depth scale.



Gain

Gain refers to amplifying the intensity of the returning sound waves on the screen display. Increasing the gain brightens the image. Decreasing the gain darkens the image.

There are two ways to adjust gain: automatically and by using the gain sliders.

To adjust gain automatically

- ❖ Tap **AutoGain**.

The system automatically balances the gain each time you tap this control. This is not a continuous function and can be applied as needed when adjustments are made to the image or the transducer location. You can customize the Auto Gain level by using the **AutoGain Adjust** control (see “[Controls in 2D](#)” on page 4-9). This customization can then be saved along with other optimizable parameters to a custom exam type.

To adjust gain by using the gain sliders

- ❖ Drag a slider left or right, to decrease or increase the gain respectively:
 - ▶ In Color or Doppler, drag the **C** (Color) or the **D** (Doppler) gain slider at the bottom of the touch panel.
 - ▶ In 2D or M Mode, tap the gain slider or the **M** (M Mode) gain slider at the bottom of the touch panel. Two additional sliders appear.
 - ▶ The upper slider adjusts the near gain of the 2D image, controlling the display intensity in the near field (nearer to the transducer).
 - ▶ The middle slider adjusts the far gain of the 2D image, controlling the display intensity in the far field (further from the transducer).
 - ▶ The lower slider adjusts the overall gain.

Note

Near and Far correspond to the time gain compensation (TGC) controls on some other ultrasound systems.

Freezing, viewing frames, and zooming

Freezing the image

Before performing certain tasks, such as viewing the cine buffer or measuring, you stop live imaging or freeze the image.

When you freeze the image, you can perform calculations. See [“About calculations”](#) on page 5-8.

To freeze the image

1 Do either of the following:

- ▶ Tap **FREEZE**.
- ▶ With two or more fingers, double-tap the touch panel.

Additional features appear on the image.

Note

You can also configure the footswitch to freeze (see [“User profile settings”](#) on page 3-34).

To unfreeze the image

❖ Do either of the following:

- ▶ Drag or swipe the **Slide to Unfreeze** slider to the right.
- ▶ With two or more fingers, double-tap the touch panel.

Related topics

Measuring 5-1

Viewing the cine buffer

While imaging, SonoSite X-Porte always retains a certain number of frames in the cine buffer. You can move forward and backward in the cine buffer.

The system clears the cine buffer when you unfreeze the image.

You can view frames in the cine buffer in Dual. See [“Dual”](#) on page 4-5.

To view frames in the cine buffer

1 Freeze the image.

2 Do either of the following:

- ▶ Drag the slider. Right moves forward, and left moves backward.

M Mode: While the slider bar represents the complete set of collected imaging data, the scrolling display shows only one cycle of imaging data at a time. The green CINE marker (▲) indicates a single column on the scrolling display, which corresponds in time to the displayed image.

- ▶ Tap the scroll arrows  or  to move forward or backward through frames one at a time.

M Mode: Tapping these controls moves the green CINE marker (▲), showing a column on the scrolling display and its corresponding image.

Other modes: The current frame number appears on the touch panel. The frame number changes as you move forward or backward.

Zooming in on the image

You can zoom in on a 2D image in 2D, M Mode, Doppler, and Color imaging. You can freeze or unfreeze the image or change the imaging mode while zooming.

When you zoom in on an image, the **Zoom** icon  appears on the image.

To zoom in live imaging

1 Tap **Zoom**.

A zoom box appears.

If this control is hidden, tapping **More Controls** displays it.

2 Size and position the zoom box over the area that you want to zoom:

- ▶ To size, pinch or spread the box, or drag .
- ▶ To position, drag the box.

3 Double-tap in the zoom box, or tap **Zoom**.

To exit zoom, double-tap in the zoom box, or tap **Unzoom**.

To zoom in Color

1 Position the Color box over the area you want to zoom.

2 Tap **Zoom**.

If this control is hidden, tapping **More Controls** displays it.

The area in the box is magnified.

To exit zoom, double-tap in the zoom box, or tap **Unzoom**.

To zoom in on a frozen image

1 Tap **Zoom**.

If this control is hidden, tapping **More Controls** displays it.

2 Do any of the following:

- ▶ To unzoom, tap **Off**.
- ▶ Drag the slider. To unzoom, drag the slider to **1.0**.

3 (Optional) Pan the image by dragging left, right, up, or down.

Note

You cannot pan the image if measurements, text, arrows, or labels exist on the image.

Visualizing needles

WARNING

To avoid incorrect needle placement when Needle Profiling is on:

- ▶ Using movement and fluid injection, verify the needle-tip location and trajectory. Needle Profiling enhances linear structures within a selected angle range on the ultrasound plane. Linear structures outside the selected angle range or the ultrasound plane—such as a bent needle—may be less apparent.
- ▶ Note that linear structures are enhanced only in an outlined portion of the image. The area outside the outline remains unchanged.
- ▶ Note that the beam divergence of a curved array transducer may prevent a segment of the needle shaft from showing in the image. The needle tip may not appear in all imaging conditions.

SonoSite X-Porte features Steep Needle Profiling technology, which can facilitate needle guidance during catheter placement and nerve-block procedures. This technology enhances linear structures within an outlined area on the screen. Linear structures are best enhanced when perpendicular to the angle guide (**Figure 4-3** on page 4-27).

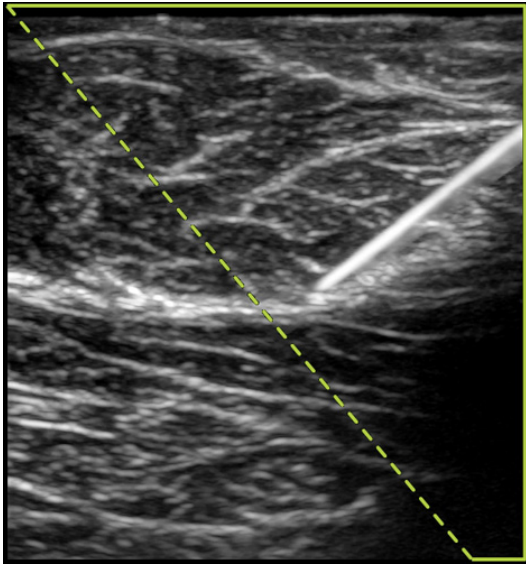

Figure 4-3 Image with Steep Needle Profiling on. The area within the green trapezoidal outline is the enhancement area.

For curved array transducers, Steep Needle Profiling technology can help identify the direction of the needle, although only segments of the needle shaft may show in the image. See [Figure 4-4](#) on page 4-27. Use movement and fluid injection to help verify the needle-tip location.

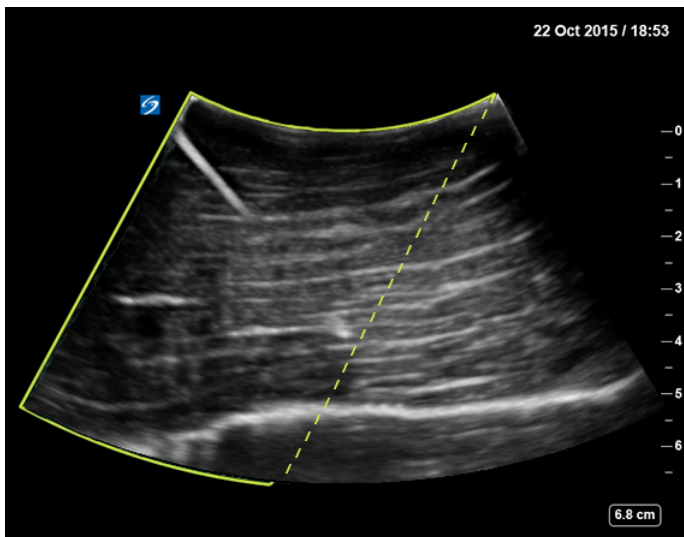

Figure 4-4 Steep Needle Profiling with a curved array

Steep Needle Profiling is available in 2D full-screen imaging only and on the following exam types.

Table 4-6: Steep Needle Profiling-compatible exam types

Transducer	Arterial	Breast	Musculoskeletal	Nerve	Small Parts	Venous
C35xp			✓	✓		
C60xp			✓	✓		
HFL38xp	✓	✓	✓	✓	✓	✓
HFL50xp		✓	✓	✓	✓	
HSL25xp	✓		✓	✓		✓
L25xp	✓		✓	✓		✓
L38xp	✓			✓	✓	✓

To use Steep Needle Profiling

- 1 In 2D imaging, tap **Needle Profiling**.

If this control is hidden, tapping **More Controls** displays it.

- 2 Ensure that the target is within the enhancement area (that is, within the outline) and that the needle, when inserted, will approach the angle guide (dashed line) perpendicularly.

- ▶ Tap **Left** or **Right** to change the enhancement area from one side of the image to another.



- ▶ Tap **Shallow**, **Medium**, or **Steep** to select a needle angle.

The needle angle sets the angle guide (dashed angled line).

- ▶ Linear transducer: Use whichever setting best provides a perpendicular intersection with the angle guide. Within the enhancement area, the more perpendicular that a linear structure is to the angle guide, the more it is enhanced. Similarly, the less perpendicular (and more parallel) that a linear structure is to the angle guide, the less it is enhanced.

- ▶ Curved transducer: Use the following table to determine the needle angle setting to use. Needle angles are measured in relation to the surface of the transducer.

Table 4-7: Shallow, Medium, and Steep setting angles

Transducer	Range for Shallow setting	Range for Medium setting	Range for Steep setting
C35xp	Less than 30°	30°-40°	Greater than 40°
C60xp	Less than 40°	40°-50°	Greater than 50°

3 Insert the needle toward the angle guide.

4 (Optional) Tap **Off** to turn off Needle Profiling.

Temporarily turning off Needle Profiling can help you identify artifacts and other structures not of interest. Tap **On** to turn it on again.

Needle size and angle

Use a 17-gauge to 25-gauge needle (recommended). Enhancement results can depend on the type and brand of needle used. For more information, consult the medical literature on needle visibility in ultrasound-guided procedures.

You can angle the needle up to 50° from the transducer surface. Beyond 50°, the needle may be less enhanced. (Needle Profiling has little or no benefit to out-of-plane procedures. Needle Profiling is intended for in-plane procedures only.)

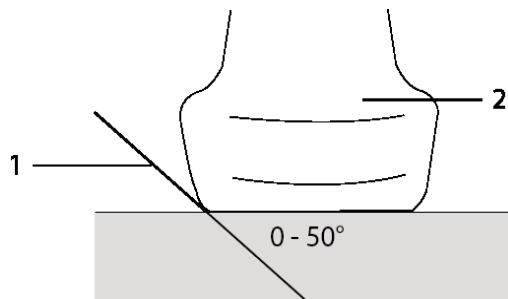

Figure 4-5 Needle size and angle: 1. Needle, 2. Transducer

For best results, angle the needle only up to 50° from the transducer surface.

Additional recommendations

Avoid setting the gain too high when using Needle Profiling, as unnecessarily high gain can cause artifacts in the image. Also, respiratory and cardiac movement in the image may cause bright pulsating artifacts.

Labeling images

You can label live, frozen, or saved images. You can label in full-screen 2D, full-screen trace, dual, or duplex. You can place text (including predefined labels), arrows, and pictographs.

To set preferences for labels, including predefined text labels, see “**Labels**” on page 3-32.

Note

If you select **Clear Labels on Unfreeze** in the Presets setup page, the system clears all labels from an image when you unfreeze the image.

Adding text labels

You can add text manually or add a predefined label.

Note



If you zoom or pan an image, the system removes text labels and arrows from the image.

To place text on an image

1 Tap **Label**.

If this control is hidden, tapping **More Controls** displays it.

2 Tap **Text** and do any of the following:

- ▶ To specify that text and predefined labels connect when you enter them, instead of being placed separately, tap . Tap  to insert text and predefined labels separately.
- ▶ To place text manually, tap in the field at the top of the form, type text, and then tap **Done**.
- ▶ To add one or more predefined labels, tap them and then tap **Done**.

Note

To replace a label you've added with another label, tap the added label in the field at the top of the form, and then tap the label with which you want to replace the added label.

- ▶ To place text manually and add a predefined label, type text in the field at the top of the form, tap in the field again, and then tap one or more predefined labels. Collapse the onscreen keyboard by tapping outside the keyboard area or tapping . Tap **Done**.
- ▶ To clear text or predefined labels, tap **Clear**.
- ▶ To undo changes and return to the image, tap **Cancel**.
- ▶ To undo changes and return to 2D imaging, tap **2D**.

3 Drag the text label to the desired location.

4 Make changes as needed:

- ▶ To edit the text, select it in the **Label** list and tap **Edit**.
- ▶ To remove the text, select it in the **Label** list and tap **Delete**.
- ▶ To remove all text labels, tap **Remove All Text** in the **Label** list.

Adding arrows

You can add an arrow graphic to point out a specific part of the image. The system deletes arrows from the image when you zoom, pan, or unfreeze the image.

To place an arrow on an image

1 Tap **Label**.

If this control is hidden, tapping **More Controls** displays it.

2 Tap **Arrow**.

3 Position and orient the arrow:

- ▶ To position the arrow, drag it.
- ▶ To orient the arrow, drag the circle's edge.

To remove the arrow, select it and then tap **Delete** in the **Arrow** list.

Adding pictographs

The pictograph set available depends on transducer and exam type. Each pictograph you place includes a transducer orientation icon.

To place a pictograph on an image

1 Tap **Label**.

If this control is hidden, tapping **More Controls** displays it.

2 Tap **Picto**.

3 Tap the desired pictograph, and then tap **Done**.

4 Drag the pictograph to the desired location.

5 Position and orient the transducer orientation icon:

- ▶ To position the icon, drag it.
- ▶ To orient the icon, drag the circle's edge.

To remove the pictograph, select it, and then tap **Delete** in the **Picto** list.

Setting the home position

The home position is the position in which the system places labels by default.

To reset the home position

- 1 Place text on an image.
- 2 Drag the label to the desired home position.
- 3 Tap **Set Home** in the **Label** list.

Labeling during review

You can label images during review. You can also label a frame from a video clip during review.

To review images and video clips

- ❖ Tap **REVIEW**, and then do either of the following:
 - ▶ Review the current exam.
 - ▶ Review a completed exam: Tap **Patient List**. In the patient list, select the exam, and then tap **Thumbnails**.

To label in review

- 1 In **Review**, tap the image or video clip you want to label:
To view the previous or next image or video clip, tap **Prev** or **Next**.
 - 2 (Video clips only) Tap the pause button, and then drag the slider to the frame you want to label.
 - 3 Tap **Labels**.
 - 4 Do one of the following:
 - ▶ Place the label:
 - ▶ For text, see [“To place text on an image”](#) on page 4-30.
 - ▶ For an arrow, see [“To place an arrow on an image”](#) on page 4-31.
 - ▶ For a pictograph, see [“To place a pictograph on an image”](#) on page 4-31.
- Note** | If you play a video clip, the system removes labels applied to the current frame.
- ▶ Cover an existing label: tap **Labels**, and then tap **Mark Out**. The system places a black rectangle on the image.
 - ▶ To reposition the Mark Out box, drag it.

- ▶ To resize the Mark Out box, drag the round handle at the corner of the Mark Out box.
- ▶ To delete the Mark Out box, select the Mark Out box in the **Mark Out** list and then tap **Delete**.

The system displays the image or video clip in full-screen mode.

5 Tap **Save**.

The system saves the labeled image to the exam.

6 Tap **Done** to exit labels and return to review.

Entering patient information

The patient form lets you enter identification, exam, and clinical details for the patient exam. This information appears in the patient report.

After you begin a new patient form, all images, video clips, and other information you save during the exam are linked to that patient.

You can enter patient information by:

- ▶ Entering the information manually (see [“Entering patient information manually”](#) on page 4-34).
- ▶ Importing information from a DICOM worklist server (see [“Entering patient information from the worklist”](#) on page 4-34).
- ▶ Scanning a patient bar code and obtaining patient information from a worklist server (see [“To enter patient information from the worklist with a bar code scanner”](#) on page 4-34).
- ▶ Scanning a patient bar code to obtain the patient ID (see the *Bar Code Scanner User Guide*).

Editing patient information

You can edit patient information if the exam has not been archived or exported and if the information is not from a worklist.

To edit patient information

1 Tap **PATIENT**.

2 Make changes as desired.

3 Collapse the onscreen keyboard by tapping outside the keyboard area or tapping .

4 Tap **Done**.

5 Do any of the following:

- ▶ Tap **Modify** to save the changes to the current patient.

- ▶ Tap **New** to start a new patient exam.
- ▶ Tap **Cancel** to discard your changes.

Entering patient information manually

To enter patient information manually

- 1 End the previous exam (see “[Ending the exam](#)” on page 4-37).
- 2 Tap **PATIENT**.
- 3 Tap a text box, and fill in the fields (see “[Patient form fields](#)” on page 4-37).
- 4 Tap **Done**.

Entering patient information from the worklist

Using the worklist, you can import patient information from the Hospital Information System or Radiology Information System. (DICOM worklist is a licensed feature.)

The worklist is available after you do the following:

- ▶ Connect the system to the network
- ▶ Configure the system for DICOM transfer
- ▶ Select a worklist server for the active location

See “[DICOM](#)” on page 3-14.

To enter patient information from the worklist with a bar code scanner

WARNING

To avoid damage to the eye, do not stare into the beam. The bar code scanner is a Class 2 laser product.

Note

Before using the bar code scanner with patients, verify that any custom programming is working as expected.

You can specify that the system query the worklist for patient information when you scan a patient ID bar code.

- 1 On the User Profile setup page, select **Bar Code Auto Query** (see “[User profile settings](#)” on page 3-34).
- 2 Scan the patient's bar code.

The system queries the worklist and imports the information into the patient form.

To enter patient information from the worklist

- 1 Tap **PATIENT**.
- 2 Tap **Worklist**.
- 3 To sort the worklist, tap a column heading to sort by. By default, the worklist sorts in ascending order.
- 4 Do any of the following:
 - ▶ To select one or more procedures for the patient, tap the procedure or procedures. You can select multiple procedures only for the same patient.
 - ▶ To requery the server for an updated worklist, tap **Update**.
- 5 Tap **Select**.

The system populates the patient form. (Patient information from the worklist is uneditable.)

To return to the patient form without selecting a procedure, tap **Back**.

To view scheduled procedures

The patient information that you import from the worklist includes scheduled procedures.

- ❖ On the patient form, see the following lists under **Scheduled Procedures**:
 - ▶ **Name** Scheduled procedures
 - ▶ **Protocol** Protocol for the selected procedure
 - ▶ **Meaning** Definition of the selected procedure

To change the procedure

You can select a procedure different from the scheduled procedure.

- 1 Under **Performed Procedure** on the patient form, select the desired procedure from the **Code** list.

The definition of the procedure appears in the **Meaning** field.
- 2 If you want to modify the **Code** list, tap **Edit**, and do one of the following:

Note | Required fields are marked with asterisks.

- ▶ Add an item: Tap **Add New**, and then fill in the **Code**, **Code Scheme Name**, and **Meaning** fields, and then tap **Save**.
- ▶ Delete an item: Select the item, and then tap the delete icon.

Updating and querying the worklist

The worklist automatically updates if set up for an automatic worklist query (see “DICOM” on page 3-14). You can also manually update the worklist, and you can query the worklist server for a matching patient procedure.

The following table shows the parameters used for worklist queries. You set parameters on the worklist configuration page (see “DICOM” on page 3-14).

Table 4-8: Query parameters

	Manual Patient Query	Manual Update from Worklist	Automatic Query Update
Patient Data	✓		
Date Range	✓	✓	✓
This Device Only		✓	✓
Automatic Query On/Off			✓
Occurs Every			✓
Start Time			✓

To manually update the worklist

- 1 On the patient form, tap **Worklist**.
- 2 Tap **Update**.

To perform a manual query

- 1 On a new patient form, do any of the following:
 - ▶ Fill in any of the following fields for the query: **Last, First, Middle, Accession, or ID**.
The query is on the characters you enter. For example, *Smith* returns *Smith, Smithson, Smithy*.
 - ▶ Under **Additional Worklist Query Parameters**, specify any of the following:
 - ▶ **Modality** Select a procedure type from the list. US (Ultrasound) is the default.
 - ▶ **Requested Procedure ID** Type a procedure ID.

2 Tap **Query**.

The worklist appears with the query results. The number of results is in the lower right screen. The time of the last query appears below the worklist.

3 Highlight the patient procedure you want, and then tap **Select**.

The system imports the information into the patient form.

Ending the exam

Note

Although you cannot add images and video clips to a patient exam that is ended, you can automatically start a new patient exam that has the same patient information. See [“To append images and video clips to a patient exam”](#) on page 4-42.

When you end an exam, the system resets imaging settings to the default settings for the selected exam type.

1 Make sure that you have saved images and other information that you want to keep (see [“Saving images and video clips”](#) on page 4-47).

2 Do either of the following:

- ▶ Tap **PATIENT**, and then tap **End Exam**.
- ▶ Tap **End Exam** in imaging, in review, or in worksheets. The system returns to the startup location as specified in User Profile settings (see [“User profile settings”](#) on page 3-34).

If **End Exam** isn't visible in imaging, specify that it appears as one of the four custom controls. See [“User profile settings”](#) on page 3-34.

Patient form fields

Field descriptions

The patient form fields available depend on exam type. In some fields, you can enter symbols and special characters (see [“To enter text using the onscreen keyboard”](#) on page 2-23).

Patient

- ▶ **Last, First, Middle** Patient name
- ▶ **ID** Patient identification number

Note

The **Generate Patient ID** option enables the system to auto-generate a unique patient ID to accommodate certain workflows. For more information, see [“General preferences”](#) on page 3-31.

- ▶ **Date of Birth**

- ▶ **Gender**
- ▶ **Accession** Enter number, if applicable
- ▶ **Indications** Enter desired text

Exam

▶ **Exam**

The exam types available depend on transducer (see “[Selecting a transducer and exam type](#)” on page 2-27). An asterisk next to an exam type indicates that it is a system-defined exam type (see “[Customizing exam types](#)” on page 3-33).

▶ **BP**

(Cardiac or Arterial exam) Blood Pressure

▶ **HR**

(Cardiac or Arterial exam) Heart Rate. Enter the beats per minute. Saving the heart rate using a measurement overwrites this entry.

▶ **Height**

(Cardiac exam) The patient height in feet and inches or meters and centimeters. To change the units, see “[Presets settings](#)” on page 3-31.

▶ **Weight**

(Cardiac exam). The patient weight in pounds or kilos. To change the units, see “[Presets settings](#)” on page 3-31.

▶ **BSA**

(Cardiac exam) Body Surface Area. Automatically calculated after you enter height and weight.

▶ **Twins**

(Obstetrical exam) Select the Twins check box to display Twin A and Twin B measurements on the calculations menu and for access to Twin A and Twin B screens for previous exam data.

▶ **LMP or EDD**

(Obstetrical or Gynecology exam) In an Obstetrical exam, select LMP or EDD and then enter either the date of the last menstrual period or the established due date. In a Gynecology exam, enter the date of the last menstrual period. The LMP date must precede the current system date.

▶ **Previous Exams**

(Obstetrical exam) Displays fields for five previous exams. The date for a previous exam must precede the current system date. For twins, select Twin A/B to toggle between Twin A and Twin B screens. (If the Twin A/B control does not appear, tap **Back**, and make sure that the Twins check box is selected.)

▶ **NT Credential**

(Obstetrical exam) A combination of letters and numbers representing an Nuchal Translucency (NT) credential ID number. For example, P12345.

Facility

▶ **Institution**

▶ **Department ID**

▶ **User**

▶ **Reading Doctor**

▶ **Referring Doctor**

Acute Care Worksheets

If the Acute Care Worksheets licensed option is installed on your system, the patient form displays these fields, which also appear in the patient's Acute Care worksheet:

▶ **MR #**

Medical record number.

▶ **Clinical Category**

The exam's clinical category.

▶ **Exam Visit**

Initial or Repeat.

▶ **Primary Obtaining/Interpreting**

The primary person obtaining or interpreting the images.

▶ **Secondary Obtaining/Interpreting**

The secondary person obtaining or interpreting the images.

▶ **Additional Obtaining/Interpreting**

Any additional person obtaining or interpreting the images.

Routing Selection

When you associate one or more routing selections with an exam, the system reflects the routing selections in the patient report and in the Acute Care worksheet (if the Acute Care Worksheets licensed option is installed). See [“Worksheets and reports”](#) on page 5-50.

If you have specified a DICOM archiver as an Educational archiver, setting routing selections in the patient form affects how exams are archived. For more information, see [“Routing selections”](#) on page 3-36.

▶ **Procedural**

▶ **Diagnostics**

▶ **Educational/Accreditation**

Scheduled Procedure

Procedure fields are available only if the DICOM worklist feature is licensed and configured. See [“DICOM”](#) on page 3-14.

- ▶ **Scheduled Procedure: Name**
- ▶ **Scheduled Procedure: Protocol**
Protocol for the selected procedure
- ▶ **Scheduled Procedure: Meaning**
Definition of the selected procedure
- ▶ **Performed Procedure: Code**
Desired procedure
- ▶ **Performed Procedure: Edit**
Enables you to modify the Code list
- ▶ **Performed Procedure: Meaning**
Definition of the performed procedure
- ▶ **Additional Worklist Query Parameters: Modality**
Procedure types
- ▶ **Additional Worklist Query Parameters: Requested Procedure ID**
The procedure ID

Images and clips

Reviewing

You can review images and video clips from both current and completed exams.





To measure during review, see [“Measuring during review”](#) on page 5-57.

Patient list

The patient list organizes saved images and video clips in patient exams. You can sort the patient list, view and delete exams, edit patient information, and append images and video clips to an existing exam.

From the patient list, you can also export exams to a USB memory stick, select a routing selection to associate with an exam, or archive exams to a DICOM archive server. For more information, see [“To connect a USB memory stick for importing or exporting”](#) on page 2-19, [“To associate a routing selection after an exam”](#) on page 3-37, and [“Archiving exams”](#) on page 4-44.

Column headings in the patient list indicate:

- ▶ **Name** Patient name
- ▶ **ID** Patient ID
- ▶ **Date/Time** The date and time of the exam
- ▶  The user who performed the exam
- ▶  The number of images and video clips saved with the exam
- ▶  The archive status of the exam
- ▶  The export status of the exam

To display the patient list

- 1 Do one of the following:
 - ▶ Tap **REVIEW**, and then tap **Patient List**.
 - ▶ Tap **Patient**, and then tap **Patient List**.

To sort the patient list

By default, the patient list is sorted by date and time, with the most recent patient listed first. You can re-sort the patient list.

- ❖ Tap the column heading that you want to sort by. Tap it again to sort in reverse order.

To select all exams in the patient list

- ❖ Tap **Select All**.
 - To deselect all exams, tap **Clear All**.

To delete an exam

- 1 In the patient list, select the check box next to one or more exams.
- 2 Tap **Delete**.

To view exam information

- 1 Tap the exam in the patient list.
- 2 Tap **Info**.

To edit patient information from the patient list

You can edit patient information from the patient list instead of from the patient form if the exam is ended but has not been exported or archived.

- 1 Tap the exam in the patient list.
- 2 Tap **Edit**.
- 3 Fill in the text boxes, and tap **Done**.

To append images and video clips to a patient exam

Although you cannot add images and video clips to a patient exam that is ended, you can automatically start a new patient exam that has the same patient information. Depending on your archiver, the two exams appear as one study when exported or archived.

- 1 Tap the exam in the patient list.
- 2 Tap **Append**.
A new patient form appears. The form has the same information as the exam you selected.



Reviewing images and video clips

You can review images and video clips in only one patient exam at a time. The system displays images and video clips in the order in which they were saved.

Video clips play automatically after loading. The load time depends on video clip length.

To review images and video clips

- 1 Tap **REVIEW**, and then do either of the following:
 - ▶ Review the current exam.
 - ▶ Review a completed exam: Tap **Patient List**.
In the patient list, tap the exam, and then tap **Thumbnails**.
- 2 Do any of the following:
 - ▶ To view the previous or next image or video clip, tap **Prev** or **Next**.
 - ▶ To view images or video clips full-screen, tap **Full Screen**. Swipe left or right to view the previous or next item.
 - ▶ To return to multi-image display, tap **Thumbnails**.
- 3 (Video clips only) Do any of the following:
 - ▶ To pause the video clip, tap the pause button.

- ▶ To play the video clip, tap the play button.
- ▶ To select a playback speed, tap .
- ▶ To move forward through frames one at a time, tap .
- ▶ To move backward through frames one at a time, tap .

4 (Optional) Do any of the following:

- ▶ Label an image or a frame from a video clip (see [“Labeling during review”](#) on page 4-32).
- ▶ View the report (see [“Worksheets and reports”](#) on page 5-50).
- ▶ Delete an image or video clip: select the image or video clip, and then tap **Delete**.

5 Return to the patient list by tapping **Patient List**, or return to imaging by tapping **Exit Review**.

Printing images

For information about printing worksheets and reports or about DICOM printing, see [“Printing reports and worksheets”](#) on page 5-54 and [“Archiving exams”](#) on page 4-44.

Caution

Printing an image does not necessarily capture all of the characteristics of the image displayed on the clinical monitor. The printout is intended for documentation purposes, and may not be suitable for diagnosis. The printed image is subject to degradation due to age and ambient light conditions.

To print while imaging

- 1 Make sure that the power button on the printer is in the On position.
- 2 With the image displayed, tap **Print**.

Note

You can also configure the footswitch to print (see [“User profile settings”](#) on page 3-34).

To print a saved image from a current or ended exam

- 1 Make sure that the power button on the printer is in the On position.
- 2 Tap **REVIEW**.
- 3 Do one of the following:
 - ▶ Select the check box for an image from a current exam.
 - ▶ Select an image from an ended exam: Tap **Patient List**, tap the exam, tap **Thumbnails**, and then select the check box for an image.

4 Tap **Full Screen**.

5 Tap **Print**.

Archiving and exporting

The patient list organizes saved images and video clips in patient exams.

You can archive exams from the patient list to a DICOM archive server or print them to a DICOM printer. You can export exams to a USB memory stick.

Note

The system does not support software-encrypted USB memory sticks.

Archiving exams

If you have configured the system for DICOM transfer, the system automatically archives saved images and video clips, along with the patient report, to DICOM devices. If you have configured the system to connect to a DICOM printer, exams are also printed when they are archived.

The system archives images and video clips either during the exam or at the end of the exam, depending on the settings you have chosen in the **Transfer Images** setting on the **Location** configuration page. Exams are printed only at the end of an exam.

You can also manually archive exams.



The Archive in Progress icon  is animated when patient exams are archiving. Pending exams are archived starting at the top of the patient list.



To verify that exams transferred

1 Tap **REVIEW**.

2 Tap **Patient List**.

The  column shows the status of exam transfer.

- ▶  Patient exam is archived.
- ▶  Patient exam is archive suspended. Network connection settings may be wrong (see [“Connecting to the network”](#) on page 3-15), or there may be a network or server problem. The exam needs to be manually archived (see [“To manually archive exams”](#) on page 4-45).

- ▶  Storage commitment was successful.
- ▶  Storage commitment for this exam is suspended.

Exams with no status markers are pending archiving.

To display information about an exam

You can display information about an exam, including transfer details.

- 1 Tap **REVIEW**.
- 2 Tap **Patient List**.
- 3 In the patient list, select the exam.
- 4 Tap **Info**.

To manually archive exams

- 1 Verify the following:
 - ▶ The correct location is selected (see [“To specify the system location”](#) on page 3-12).
 - ▶ If the system is connected to a network via an Ethernet connection, the LAN link light (green LED) next to the Ethernet connector is on.
 - ▶ For a wireless connection, the wireless connected icon  appears in the system status area on the clinical monitor.
- 2 Tap **REVIEW**.
- 3 Tap **Patient List**.
- 4 Select the check box next to one or more exams.
- 5 Tap **Archive**. (The system removes any status markers.)

To discontinue MPPS for an exam

You can discontinue MPPS for an exam before completing the exam.

- ❖ On the patient form, tap **Discontinue**.

Exporting exams

Caution

To avoid losing data from or damaging the USB memory stick, do not remove the USB memory stick or turn off the ultrasound system while exporting. In addition, do not bump or apply pressure to the USB memory stick while it is connected to the system. The connector could break.

You can export patient exams if they are ended and if the system administrator has not disabled USB export. See [“Ending the exam”](#) on page 4-37 and [“Administration settings”](#) on page 3-1. Exams include images, video clips, and the patient report.

A USB memory stick is for temporary storage of images and clips. Archive patient exams regularly.

To export patient exams manually to a USB memory stick

- 1 Specify the file format for exported images (see [“USB settings”](#) on page 3-39).
- 2 Tap **REVIEW**.
- 3 Tap **Patient List**.
- 4 Connect a USB memory stick (see [“To connect a USB memory stick for importing or exporting”](#) on page 2-19).
- 5 In the patient list, select the check box next to one or more exams.
- 6 Tap **Export USB**. A list of USB devices appears.
- 7 Select the USB memory stick. If you want to hide patient information, deselect **Include patient information on images and video clips**.
- 8 Tap **Export**.

The files are finished exporting approximately five seconds after the USB animation stops. Removing the USB memory stick or turning off the system while exporting may cause exported files to be corrupted or incomplete. To stop in-progress exporting, tap **Cancel**.

The  column of the patient list indicates whether the system has exported the exam.

To export patient exams automatically to a USB memory stick

- 1 Make sure that automatic export is enabled. See [“To specify export options”](#) on page 3-39.
- 2 Insert a USB memory stick into a USB port on the side of the system.
- 3 End the exam.

Saving images and video clips

You can save images and video clips to internal storage. The system plays a sound if Beep Alert is on (see [“Audio settings”](#) on page 3-6), and the Save in Progress icon  briefly appears on the clinical monitor.

The system limits the maximum number of images and video clips that you can save for an individual exam, and warns you when this limit is reached.

You can also save a labeled frame from a video clip. See [“Labeling during review”](#) on page 4-32.

To review saved images and video clips for the current patient, tap **REVIEW**. For patients whose exams have ended, you must go to the Patient List by tapping **REVIEW** and then **Patient List**. See [“Reviewing”](#) on page 4-40. For information on viewing the cine buffer, see [“Viewing the cine buffer”](#) on page 4-24.

You can also save images from cine while the system is frozen.

Saving images

To avoid mixing images saved from multiple patients, make sure that the patient ID is displayed before you save an image. See [“Entering patient information”](#) on page 4-33 and [“Display Information settings”](#) on page 3-28.

To save an image

If the **Save Image** or **Save Image & Calcs** control is not available, configure the system to display it. See [“To configure custom controls”](#) on page 3-35.

- ❖ Do either of the following:
 - ▶ To save only the image, tap **Save Image**.
 - ▶ To save the image and to save the current calculation to the patient report, tap **Save Image & Calcs**.

Note

You can also configure the footswitch to save (see [“User profile settings”](#) on page 3-34).

Saving video clips

To set video clips controls

1 Tap **Video Clip Settings**.

If this control is hidden, tapping **More Controls** displays it.

2 Set the following as desired:

- ▶ **Clip Method**

- ▶ **Prospective** captures frames after you tap **Save Video Clip**. The system captures frames for the number of seconds or beats you specify in the **Time** or **ECG** list. A forward clip symbol displays in the system status area.
- ▶ **Retrospective** captures frames from presaved data available before you tap **Save Video Clip**. The system captures presaved frames for the number of seconds or beats you specify in the **Time** or **ECG** list. A backward clip symbol displays in the system status area.

▶ **Clip Type**

- ▶ **Time** captures based on number of seconds. Select the time duration from the **Time** list.
- ▶ **ECG** captures based on the number of heart beats. Select the **R-Wave Count**.

▶ **Preview Video Clip**

Select this option to automatically play and optionally trim a captured video clip (the video clip does not save automatically to internal storage). If this option is deselected, the video clip saves to internal storage, and trim controls are not available.

3 Tap Done.

To capture and save a video clip

1 Make sure that video clips settings are set as desired. See [“To set video clips controls”](#) on page 4-47.

2 Tap **Save Video Clip**.

Note

You can also configure the footswitch to save a video clip (see [“User profile settings”](#) on page 3-34).

If **Clip Method** is set to **Retrospective**, the system beeps if Beep Alert is on (see [“Audio settings”](#) on page 3-6), and then captures presaved frames for the number of seconds you specify in the **Time** list.

If **Clip Method** is set to **Prospective**, the system beeps if Beep Alert is on (see [“Audio settings”](#) on page 3-6), and then captures frames for the number of seconds you specify in the **Time** list, and then beeps again. Tap **Stop Video Clip** to end capture before the number of seconds specified in the **Time** list.

If **Preview Video Clip** is selected in **Video Clip Settings**, the video clip automatically begins playing on the clinical monitor.

3 (Optional, Preview Video Clip only) Trim the video clip:

- a** Tap the scissors icon.
- b** Drag the trim sliders to remove frames from the left or right sides of the video clip.

4 Tap **Save**.

Note

Tapping **Done** discards the video clip.

Managing internal storage space

Your system administrator can configure the system to auto-delete exams that have been archived or exported (see [“Configuring Auto Delete”](#) on page 3-5). Otherwise, exams must be manually deleted.

The save available icon in the system status area (see [Figure 2-4](#) on page 2-20) shows the percentage of space available in internal storage.

To receive alerts when storage is near capacity, see [“To receive storage alerts”](#) on page 3-13.

If you try to save an image or video clip when space is low, the system alerts you that internal storage is low and prompts you to delete archived or storage committed patient exams.

If memory is full, the system displays the Memory Full icon .

DVR recording

You can record video displayed on the clinical monitor to a USB memory stick inserted into the DVR USB port. Clips save as MP4 files. You can copy the recordings to another device.

Note | The system does not support software-encrypted USB memory sticks.

When recording to a USB memory stick, make sure the memory stick is empty of other data, files, or folders before inserting it into the system. The X-Porte system may not recognize a USB memory stick that contains unrelated folders or files.

Note | FAT32 formatting of the USB memory stick is required.

You cannot record video if the system administrator has selected **Disable USB Export** in Administration setups (see [“Administration settings”](#) on page 3-1).

To record to the DVR

1 Make sure that a USB memory stick is inserted into the DVR USB port.

The DVR USB port is located on the rear of the stand's dock (see [“Ports”](#) on page 2-33).

Note | Wait at least five seconds between removing and reinserting a USB memory stick into the DVR USB port. The system may take up to two minutes to recognize the USB memory stick.

2 Tap **Rec** at the upper right of the touch panel.

Note

You can also configure the footswitch to record (see “[User profile settings](#)” on page 3-34).

The system begins recording to the USB memory stick in the DVR port and displays a flashing recording indicator.

Note

If **Rec** is not available, check to make sure that the DVR has a USB memory stick inserted and that the USB memory stick is not full.

3 To stop recording, tap **Rec**, or end the exam.

To copy DVR recordings to another device

1 After you stop recording, remove the USB memory stick from the DVR.

2 Insert the USB memory stick into another device (for example, a personal computer).

3 Display the USB memory stick's contents and copy the recordings (MP4 files) to the device.

Note

If video recorded from the DVR is too bright when you view it on a personal computer, you can adjust the video color settings on your PC's monitor. For example, change the Dynamic Range to Full. See your computer's Help for information about available video color settings.

Image Gallery

Image Gallery enables you to view images and video clips from a USB memory stick.

WARNING | Images in the Image Gallery should not be used for diagnostic purposes.

Note | The system does not support software-encrypted USB memory sticks.

To view images using Image Gallery

1 Insert a USB memory stick into a USB port on the X-Porte system.

Note | The image and clip files that you want to view must be stored on the root level of the USB memory stick in order for Image Gallery to access them.

2 Tap **MORE**, and then tap **USB Image Gallery**.

3 On the **Image Gallery** page, select your desired storage device from the list. A gallery of available images and clips appears.

4 To open a full-screen view of an image or clip, tap the thumbnail image.

5 To select multiple images or clips, select the check box for each image, or tap **Select All**.

6 To delete selected images, tap **Delete**.

Export individual images and clips

You can export individual images and clips to a USB memory stick for viewing in the USB Image Gallery. Individually exported images and clips are saved as .jpg and .avi files, and do not contain other study information.

Note | Use this method of export to produce only individual image and clip files. This method of export will not export the complete patient study and will not mark the study as **Exported** in the patient list.

To export images

1 Insert a USB memory stick into a USB port on the X-Porte system.

2 On an active exam, tap **REVIEW**.

3 (Option) To export images or clips from a closed exam:

a On the **Review** page, tap **Patient List**.

b On the **Patient List** page, select a patient record and tap **Thumbnails**.

4 On the **Review** page, select the check box next to each image or clip that you want to export.

5 Tap **Export USB**.

- 6 To change the file name, tap the **Please enter a file name** box. When the keyboard appears, type the new file name using upper and lower-case letters and numbers only. Special characters and spaces cannot be used in a file name.

Note

All images and clips exported to the USB memory stick are stored on the root level of the drive. This is to facilitate viewing in Image Gallery. Files with the same name will have the name automatically incremented.

- 7 If more than one storage device is installed, tap to select the storage device you want to export to.
- 8 By default, patient information such as names and IDs are removed from images and clips before exporting. Patient information can be included during export by selecting the **Include patient information on images and video clips** check box.

Caution

Patient information maybe a protected class of patient data subject to country-specific security guidelines. If you choose to include patient information when exporting images and clips, be sure your information storage and handling practices comply with country-specific security guidelines.

9 Tap **Export**.

ECG

ECG is an option and requires a FUJIFILM SonoSite ECG cable.

ECG is available only on the cardiac exam type.

WARNING

Do not use the SonoSite ECG to diagnose cardiac arrhythmia or to provide long-term cardiac monitoring.

Caution

Use only accessories recommended by FUJIFILM SonoSite with the system. Connecting an accessory not recommended by FUJIFILM SonoSite can damage the system.

To use the ECG

- 1 Select the cardiac exam type on the P10xp, P21xp, or TEExp transducer (see **“Selecting a transducer and exam type”** on page 2-27).

2 Connect the ECG cable to the ECG port on the ultrasound system.

ECG turns on automatically.

Note

The ECG signal may take up to one minute to restabilize after defibrillator use on a patient.

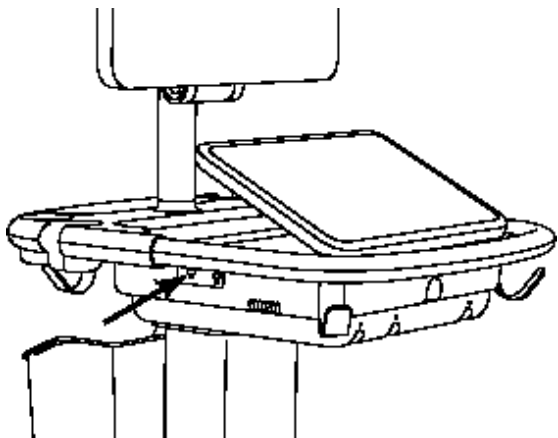

Figure 4-6 ECG port

3 Tap **ECG**.

If this control is hidden, tapping **More Controls** displays it.

4 Do any of the following in the **ECG Settings** window:

- ▶ To display the ECG signal, select **Show**.
- ▶ To adjust the value of the ECG gain, drag the **Gain** slider.
- ▶ To set the ECG scroll speed, select **Slow**, **Medium**, or **Fast** under **Sweep Speed**.

If the Doppler or M Mode trace is active, the ECG scroll speed matches the sweep speed for the trace.

- ▶ To move the ECG signal up or down vertically on the image, tap **Up** or **Down** under **Position**.

5 Tap **Done**.

CHAPTER 5

Measurements and calculations

This section provides information about measurements, calculations, worksheets, and reports.

Measuring

X-Porte offers several types of measurements.

You can perform independent measurements, or you can perform a measurement and then assign it to a calculation (see [“Assigning measurements to calculations”](#) on page 5-8). If you want to save a measurement, you must assign it to a calculation (which saves results to the patient report), or you can save the image with the calipers displayed.

If you prefer to start within a calculation, see [“About calculations”](#) on page 5-8.

Calipers

You perform most measurements by using calipers that you drag into position. The active caliper has a round highlighted handle .

To activate calipers

- ❖ Tap the caliper.

To switch between calipers

- ❖ Do any of the following:
 - ▶ Tap either caliper.
 - ▶ Tap the switch icon  beneath the measurement result on the left side of the touch panel.
 - ▶ Tap the caliper under **Measure**.

Viewing and deleting measurement results

The current measurement result appears on the left side of the touch panel under **Measure**. To assign it to a calculation, see “[Assigning measurements to calculations](#)” on page 5–8.

If you perform multiple measurements, tapping an entry under **Measure** highlights the corresponding calipers on the image.

To delete a measurement

- ❖ Tap the measurement under **Measure**, and then tap **Delete**.

Basic measurements in 2D

Note

You can measure across images in Dual only with a linear transducer, and only when the images are at the same depth and magnification.

To measure the distance between two points

- 1 On a frozen image, tap **Distance**.

A caliper appears.

If this control is hidden, tapping **More Controls** displays it.

- 2 Drag the active caliper to the first point.
- 3 Drag the other caliper to the second point.
- 4 As needed, tap and drag each caliper until it is precisely positioned.

To measure circumference or area using an ellipse

- 1 On a frozen image, tap **Ellipse**.

If this control is hidden, tapping **More Controls** displays it.

An ellipse with three calipers appears.

- 2 Position and resize the ellipse:
 - ▶ To position, drag the calipers.
 - ▶ To resize, drag the calipers, the handle, or both.

To measure circumference or area by tracing

- 1 On a frozen image, tap **Trace**.

If this control is hidden, tapping **More Controls** displays it.

A caliper appears.

- 2 Drag the caliper to the start point.

After lifting your finger from the screen, a pencil icon appears, indicating that the start location is set and you can begin your trace.

- 3 Drag the caliper around the area you want to trace.

To make a correction, trace backward on the dotted line.

- 4 To complete the measurement, remove your finger from the screen.

The trace closes automatically and the measurement results appear.

Note

Even after completing the trace, you can still adjust the measurement by dragging the cursor. Drag the cursor backward to erase your trace or forward to extend it.

To perform a Target Depth measurement

You can measure the distance from the skin line to a specified point on the image.

- 1 On a 2D image, tap **Target Depth**.

If this control is hidden, tapping **More Controls** displays it.

A dotted line appears extending from the skin line to a single caliper at the end.

- 2 Drag the caliper to the desired location.

Basic measurements in M Mode

To measure distance and time

You can measure distance in centimeters and measure time in seconds.

- 1 On a frozen M Mode sweep, tap **Distance Time**.

If this control is hidden, tapping **More Controls** displays it.

A caliper appears.

- 2 Drag the caliper to the desired location.

A second caliper appears.

3 Drag the second caliper to the desired location.

To measure heart rate

1 On a frozen M Mode sweep, tap **Heart Rate**.

A vertical caliper appears.

If this control is hidden, tapping **More Controls** displays it.

2 Drag the caliper to the peak of the heartbeat.

A second vertical caliper appears.

3 Drag the second caliper to the peak of the next heartbeat.

Saving the heart rate measurement to the patient report overwrites any heart rate entered on the patient form.

Basic measurements in Doppler

The following basic measurement tools are available in Doppler: Heart Rate, Velocity (cm/s), Manual Trace, Auto Measure, and Slope.

You can use these tools to measure:

- ▶ Heart Rate
- ▶ Velocity (cm/s)
- ▶ Peak Velocity (VMax)
- ▶ Pulsatility Index (PI)
- ▶ Resistive Index (RI)
- ▶ S/D Ratio (S/D)
- ▶ End Diastolic Velocity (EDV)
- ▶ Mean Pressure Gradient (PGMean)
- ▶ Mean Velocity (VMean)
- ▶ Elapsed Time (ET)
- ▶ Minimum Diastolic Velocity (MDV)
- ▶ Velocity Time Integral (VTI)
- ▶ Acceleration Time (AT)
- ▶ Time Average Velocity (TAV)
- ▶ Time Average Peak (TAP)
- ▶ Time Average Mean (TAM)
- ▶ Max Pressure Gradient (PGMax)
- ▶ Acceleration (Acc)
- ▶ Deceleration time (Decel)
- ▶ Pressure Half Time (PHT)

To measure heart rate

See **"To measure heart rate"** on page 5-4 under **"Basic measurements in M Mode"**, but start from a frozen Doppler spectral trace.

To measure Velocity (cm/s) and Pressure Gradient

This measurement involves a single caliper from the baseline.

- 1 On a frozen Doppler spectral trace, tap **Velocity**.

A single caliper appears.

If this control is hidden, tapping **More Controls** displays it.

- 2 Drag the caliper to a peak velocity waveform.

To measure Velocities, Elapsed Time, Ratio, and Resistive Index (RI) or Acceleration

- 1 On a frozen Doppler spectral trace, tap **Velocity**.

A single caliper appears.

If this control is hidden, tapping **More Controls** displays it.

- 2 Drag the caliper to a peak systolic waveform.

- 3 Tap **Velocity**.

A second caliper appears.

- 4 Drag the second caliper to the end diastole on the waveform.

Elapsed time between the times indicated by the two calipers is calculated.

Measured velocities are given as results, and a generic ratio between the velocities indicated by the two calipers is calculated.

If the absolute value of the earlier velocity is less than that of the later velocity identified by the calipers, Acceleration is calculated; otherwise, RI is calculated.

To measure time duration

- 1 On a frozen Doppler spectral trace, tap **Time**.

A vertical caliper appears.

If this control is hidden, tapping **More Controls** displays it.

- 2 Drag the caliper where desired.

- 3 Drag the second caliper where desired.

Performing Doppler trace measurements

Trace measurements depend upon the exam type and measurement tool.

Table 5-1: Doppler trace measurements

Tool	Exam type					
	Cardiac	OB/Gyn/ Venous	Arterial	TCD/Orbital	Lung	Other
Manual Trace	<ul style="list-style-type: none"> ▶ VMax ▶ VTI ▶ PGMMax ▶ PGMean ▶ VMean 	<ul style="list-style-type: none"> ▶ VMax ▶ PI ▶ RI ▶ SD ▶ EDV ▶ MDV ▶ TAV 	<ul style="list-style-type: none"> ▶ VMax ▶ PI ▶ RI ▶ SD ▶ EDV ▶ MDV ▶ TAV ▶ VTI 	<ul style="list-style-type: none"> ▶ VMax ▶ PI ▶ RI ▶ SD ▶ EDV ▶ MDV ▶ TAV ▶ Gate Depth 	VMax	<ul style="list-style-type: none"> ▶ VMax ▶ PI ▶ RI ▶ SD ▶ EDV ▶ MDV ▶ AT ▶ TAV
Auto Measure	<ul style="list-style-type: none"> ▶ VMax ▶ VTI ▶ PGMMax ▶ PGMean ▶ VMean 	<ul style="list-style-type: none"> ▶ VMax ▶ PI ▶ RI ▶ SD ▶ EDV ▶ MDV ▶ TAP 	<ul style="list-style-type: none"> ▶ VMax ▶ PI ▶ RI ▶ SD ▶ EDV ▶ MDV ▶ TAP ▶ VTI 	<ul style="list-style-type: none"> ▶ VMax ▶ PI ▶ RI ▶ SD ▶ EDV ▶ MDV ▶ TAP ▶ TAM ▶ Gate Depth 	VMax	<ul style="list-style-type: none"> ▶ VMax ▶ PI ▶ RI ▶ SD ▶ EDV ▶ MDV ▶ AT ▶ TAP

To perform manual trace measurements

1 On a frozen Doppler spectral trace, tap **Manual Trace**.

If this control is hidden, tapping **More Controls** displays it.

A single caliper appears.

2 Drag the caliper to the beginning of the desired waveform.

After lifting your finger from the screen, a pencil icon appears, indicating that the start location is set and you can begin your trace.

3 Drag the caliper to trace the waveform.

To make a correction, trace backward on the dotted line.

4 To complete the measurement, remove your finger from the screen.

The trace closes automatically and the measurement results appear.

Note

Even after completing the trace, you can still adjust the measurement by dragging the cursor. Drag the cursor backward to erase your trace or forward to extend it.

To measure automatically

After measuring automatically, confirm that the system-generated boundary is correct. If you are not satisfied with the trace, obtain a high-quality Doppler spectral trace image, or trace manually.

1 On a frozen Doppler spectral trace, tap **Auto Measure**.

If this control is hidden, tapping **More Controls** displays it.

A vertical caliper appears.

2 Drag the caliper to the beginning of the waveform.

If calipers are not positioned correctly, the calculation result is inaccurate.

3 Drag the second caliper to the end of the waveform and lift your finger.

The measurement results appear.

To measure slope, VMax, Decel, and PHT

The **Slope** control can only be used in the cardiac exam type.

1 On a frozen Doppler spectral trace, tap **Slope**.

A vertical caliper appears.

If this control is hidden, tapping **More Controls** displays it.

2 Drag the caliper where desired.

3 Drag the second caliper where desired.

The absolute slope between the calipers is calculated. If the absolute velocity of the earlier caliper is greater than that of the later caliper (and they are on the same side of the baseline), the deceleration time (Decel) and Pressure Half Time (PHT) are calculated.

Assigning measurements to calculations

You can assign a measurement to a calculation that includes that measurement type.

When you assign a measurement to a calculation, a checkmark appears next to the measurement indicating that it has been successfully saved.

To assign a measurement to a calculation

1 After performing the measurement, select it, and tap **Calcs**.

If this control is hidden, tapping **More Controls** displays it.

Note

If **Calcs** is unavailable, the measurement is unavailable for saving to a calculation.

A calculation list appears, along with a list of additional available lists.

2 Tap the desired calculation list.

3 Tap the desired measurement name in the calculation list.

4 Save the measurement: Tap under the measurement name.

This control is unavailable if the measurement cannot be saved to the selected calculation.

About calculations

WARNINGS

- ▶ To avoid incorrect calculations, verify that the patient information, date, and time settings are accurate.
- ▶ To avoid misdiagnosis or harming the patient outcome, start a new patient form before starting a new patient exam and performing calculations. Starting a new patient form clears the previous patient's data. The previous patient's data will be combined with the current patient if the form is not first cleared. See ["Entering patient information"](#) on page 4-33.
- ▶ To avoid misdiagnosis or harming the patient outcome, do not use single calculations as sole diagnostic criteria. Use calculations in conjunction with other clinical information.

In X-Porte you can perform calculations, whose results save to the patient report (see ["Worksheets and reports"](#) on page 5-50).

There are three kinds of calculations:

- ▶ Basic calculations that are available in multiple exam types:

- ▶ Volume calculations
- ▶ Volume Flow calculations (available in abdominal and arterial exam types only)
- ▶ Percent reduction calculations
- ▶ Specialized calculations that are specific to one exam type:
 - ▶ Abdominal calculations
 - ▶ Arterial calculations
 - ▶ Cardiac calculations
 - ▶ Gynecology calculations
 - ▶ Obstetrical calculations
 - ▶ Small Parts and MSK (musculoskeletal) calculations
- ▶ Acute Care calculations, included with the Acute Care worksheets licensed feature.

Related topics

Freezing the image	4-24
Measuring during review	57



Overview

Calculations are accessed from the calculation lists, which you display by tapping the **Calcs** control (for basic and specialized calculations) or the **Acute Care** control (for Acute Care calculations).

If these controls are hidden, tapping **More Controls** displays them.

After you tap the control, a calculation list appears on the left side of the touch panel.

Tap **Calcs** or **Acute Care** again to exit the list.

The selected measurement is highlighted with save  and delete  controls. In some measurements and calculations that use a Doppler trace, a  button has been added to make it easier to select the trace type. Calipers appear on the image.

You position the calipers by dragging. The measurement result appears beside the measurement name. After you save measurements, the calculation result appears on the clinical monitor.

If there are multiple saved measurements for a calculation, the system numbers them in the order they were completed in the calculation list on the left side of the touch panel.

To save calculation measurements

When you save a measurement, a checkmark appears next to the measurement, indicating that the value has been saved.

- ❖ With one or more measurements on the screen, do any of the following:
 - ▶ Save the selected measurement: Tap  under the measurement name.
 - ▶ Save all performed measurements in the calculation: Tap **Save All**.
 - ▶ Save both the selected measurement and the image: Tap **Save Image & Calcs**. (If the **Save Image & Calcs** control is not available, configure the system to display it (see “[User profile settings](#)” on page 3-34).

To redo or delete a saved measurement

- 1 On a frozen image, tap **Calcs** or, for the Acute Care calculations, tap **Acute Care**.

If these controls are hidden, tapping **More Controls** displays them.

- 2 In the calculation list that contains the measurement, do one of the following:

- ▶ To redo, perform the measurement again.

To save the new measurement, tap  under the measurement name. The new measurement saves to the patient report and appends the new measurement to the calculation list.

- ▶ To delete, tap  under the measurement name.

The measurement last saved is deleted from the patient report. If it is the only measurement, the result is deleted from the report.

Some measurements can be deleted directly from the report preview. See “[Worksheets and reports](#)” on page 5-50.

Percent reduction calculations

WARNINGS

- ▶ To avoid incorrect calculations, verify that the patient information, date, and time settings are accurate.
- ▶ To avoid misdiagnosis or harming the patient outcome, start a new patient form before starting a new patient exam and performing calculations. Starting a new patient form clears the previous patient's data. The previous patient's data will be combined with the current patient if the form is not first cleared. See ["Entering patient information"](#) on page 4-33.

Percent reduction calculations are available in the following exam types: Abdomen, Arterial, Musculoskeletal, and Small Parts. For a list of exam types on each transducer, see ["Selecting a transducer and exam type"](#) on page 2-27.

To calculate percent area reduction

- 1 On a frozen 2D image, tap **Calcs**.

If this control is hidden, tapping **More Controls** displays it.

- 2 In the Area Reduction calculation list, do the following for **A¹** and then for **A²**:

- a Tap the measurement name.
- b Drag the caliper to the trace starting point, and lift your finger.
- c Trace the desired area.
To make a correction, trace backward on the dotted line.
- d Complete the trace by lifting your finger.
- e To save the measurement and close the trace, tap .

The percent area reduction result appears on the clinical monitor and saves to the patient report.

To calculate percent diameter reduction

- 1 On a frozen 2D image, tap **Calcs**.

If this control is hidden, tapping **More Controls** displays it.

- 2 On the Diameter Reduction calculation list, do the following for **D¹** and then for **D²**:

- a Tap the measurement name.
- b Position the calipers by dragging.
- c Save the measurement.

The percent diameter reduction result appears on the clinical monitor and saves to the patient report.

Volume calculation

WARNINGS

- ▶ To avoid incorrect calculations, verify that the patient information, date, and time settings are accurate.
- ▶ To avoid misdiagnosis or harming the patient outcome, start a new patient form before starting a new patient exam and performing calculations. Starting a new patient form clears the previous patient's data. The previous patient's data will be combined with the current patient if the form is not first cleared. See ["Entering patient information"](#) on page 4-33.

The volume calculation involves three 2D distance measurements: Height, Width, and Length. You can calculate volume on one, two, or all three distance measurements. After any measurement is saved, the result appears on the clinical monitor and in the patient report.

The volume calculation is available in the following exam types: Abdomen, Arterial, Breast, Gynecological, Musculoskeletal, Nerve, Small Parts, Superficial, and Venous.

For a list of exam types on each transducer, see ["Selecting a transducer and exam type"](#) on page 2-27.

To calculate volume

Do the following for each image you need to measure:

- 1 On the frozen 2D image, tap **Calcs**.

If this control is hidden, tapping **More Controls** displays it.

- 2 On the **Volume 1**, **Volume 2**, or **Volume 3** calculation list, do the following for each measurement you need to take:
 - a Tap the measurement name.
 - b Position the calipers by dragging.
 - c Save the measurement.

Volume flow calculation

To calculate volume flow in the abdominal exam type, see page 5-14.

To calculate volume flow in the arterial exam type, see page 5-16.

Considerations

Consider the following factors when performing volume flow measurements:

- ▶ You should follow current medical practice for volume flow calculation applications.
- ▶ The accuracy of the volume flow calculation largely depends on the user's measurement technique.
- ▶ The factors identified in the literature that affect the accuracy are as follows:
 - ▶ Using the diameter method for 2D area
 - ▶ Precision in placing the caliper
 - ▶ Difficulty ensuring uniform insonation of the vessel

For more information about the considerations and degree of accuracy for volume flow measurements and calculations, see the following reference:

- ▶ Allan, Paul L. et al. *Clinical Doppler Ultrasound*, 4th Ed., Harcourt Publishers Limited, (2000) p.36-38.

Exam-based calculations

Abdominal calculations

WARNINGS

- ▶ To avoid incorrect calculations, verify that the patient information, date, and time settings are accurate.
- ▶ To avoid misdiagnosis or harming the patient outcome, start a new patient form before starting a new patient exam and performing calculations. Starting a new patient form clears the previous patient's data. The previous patient's data will be combined with the current patient if the form is not first cleared. See ["Entering patient information"](#) on page 4-33.

Table 5-2: Abdominal calculations

Calculation list	Measurement name (imaging mode)	Calculation result
Volume Flow*	Diam (2D), TAM, TAP, or TAV (Doppler)	Vol Flow (Volume Flow ml/min)

*See ["Considerations"](#) on page 5-13 for factors to consider when performing a volume flow calculation.

To calculate volume flow

- 1 On a frozen 2D or Doppler trace, tap **Calcs**

If this control is hidden, tapping **More Controls** displays it.

- 2 On the calculation list, tap **Volume Flow**.

Steps 3 and 4 can be done in either order.

- 3 Measure blood vessel diameter:

- a On a frozen 2D image, on the **Volume Flow** menu, tap **Diam**.

- b Position the calipers by dragging.

- c Tap  to save the measurement.

- 4 Calculate the blood velocity.

- a On a frozen Doppler trace, on the **Volume Flow** menu, tap **TAP** (peak). To use a different velocity measurement, tap , and then choose either **Mean** or **Manual**.

- b For **Manual**, trace the waveform by dragging the calipers.

To make a correction, trace backward on the dotted line.

- c For **Peak** or **Mean**, position the vertical calipers by dragging.

- d Tap  to save the measurement.

- 5 Tap **WORKSHEET** to view the results.

Arterial calculations

WARNINGS

- ▶ To avoid incorrect calculations, verify that the patient information, date, and time settings are accurate.
- ▶ To avoid misdiagnosis or harming the patient outcome, start a new patient form before starting a new patient exam and performing calculations. Starting a new patient form clears the previous patient's data. The previous patient's data will be combined with the current patient if the form is not first cleared. See **"Entering patient information"** on page 4-33.

The Arterial calculations that you can perform are listed in **Table 5-3** on page 5-15.

In the Arterial exam, you can also calculate ICA/CCA ratio, volume, volume flow, and percent reduction. See **"Volume calculation"** on page 5-12, **"Volume flow calculation"** on page 5-12, and **"Percent reduction calculations"** on page 5-11.

Table 5-3: Arterial calculations

Calculation list	Measurement name
Right	<ul style="list-style-type: none"> ▶ CCA ▶ Proximal ▶ Middle ▶ Distal ▶ Bulb
	<ul style="list-style-type: none"> ▶ ICA ▶ Proximal ▶ Middle ▶ Distal
	<ul style="list-style-type: none"> ▶ ECA ▶ Proximal ▶ VA
Left	<ul style="list-style-type: none"> ▶ CCA ▶ Proximal ▶ Middle ▶ Distal ▶ Bulb
	<ul style="list-style-type: none"> ▶ ICA ▶ Proximal ▶ Middle ▶ Distal
	<ul style="list-style-type: none"> ▶ ECA ▶ Proximal ▶ VA

Table 5-3: Arterial calculations

Calculation list	Measurement name
Volume Flow ^a	Diam(2D),TAM, TAP, or TAV (Doppler) ^b

^aSee “**Considerations**” on page 5-13 for factors to consider when performing a volume flow calculation.

^bWhen the Doppler trace is measured, the result includes velocity time integral and time averaged velocity calculations depending upon the trace type. When the waveform is manually traced, TAV and VTI are displayed. When the waveform is automatically traced using Peak, Time Averaged Peak (TAP) and VTI are displayed. When the waveform is automatically traced using Mean, Time Averaged Mean (TAM) is displayed and VTI is not displayed.

WARNINGS

- ▶ Trace only a single heartbeat. The VTI calculation is not valid if measured with more than one heartbeat.
- ▶ Diagnostic conclusions about blood flow based on VTI alone can lead to improper treatment. Accurate blood flow volume calculations require both the vessel area and velocity of blood flow. In addition, accurate blood flow velocity is dependent on a correct Doppler angle of incidence.

Calculation results for each measurement include s (systolic) and d (diastolic).

To perform an Arterial calculation

- 1 On a frozen Doppler spectral trace, tap **Calcs**.
- 2 Do the following for each measurement you want to take:
 - a Select the calculation list that contains the measurement name.
 - b Drag the caliper to the peak systolic waveform, and tap **Next**.
A second caliper appears.
 - c Drag the caliper to the end diastole point on the waveform.
 - d Tap  under the measurement name.

To calculate volume flow

- 1 On a frozen 2D or Doppler trace, tap **Calcs**.
If this control is hidden, tapping **More Controls** displays it.
- 2 On the calculation list, tap **Volume Flow**.

3 Calculate Volume Flow 1.

a Measure the blood vessel diameter:

- i On a frozen 2D image, on the **Volume Flow** menu, tap **Diam**.
- ii Position the calipers by dragging.
- iii Tap  to save the measurement.

b Calculate the blood velocity:

- i On a frozen Doppler trace, on the **Volume Flow 1** menu, tap **TAP** (peak). To use a different velocity measurement, tap  and then choose either **Mean** or **Manual**.

Note

Using the **Mean** option will not provide a VTI measurement.

- ii For **Manual**, trace the waveform by dragging the calipers. To make a correction, trace backward on the dotted line.
- iii For **Peak** or **Mean**, position the vertical calipers by dragging.
- iv Tap  to save the measurement.

4 Calculate Volume Flow 2.

a Measure blood vessel diameter

- i On a frozen 2D image, on the **Volume Flow 2** menu, tap **Diam**.
- ii Position the calipers by dragging.
- iii Tap  to save the measurement.

b Calculate the blood velocity.

- i On a frozen Doppler trace, on the **Volume Flow** menu, tap **TAP** (peak). To use a different velocity measurement, tap  and then choose either **Mean** or **Manual**.

Note

Using the **Mean** option will not provide a VTI measurement.

- ii For **Manual**, trace the waveform by dragging the calipers. To make a correction, trace backward on the dotted line.
- iii For **Peak** or **Mean**, position the vertical calipers by dragging.
- iv Tap  to save the measurement.

5 Tap **WORKSHEET** to view the results.

Cardiac calculations

WARNINGS

- ▶ To avoid incorrect calculations, verify that the patient information, date, and time settings are accurate.
- ▶ To avoid misdiagnosis or harming the patient outcome, start a new patient form before starting a new patient exam and performing calculations. Starting a new patient form clears the previous patient's data. The previous patient's data will be combined with the current patient if the form is not first cleared. See [“Entering patient information”](#) on page 4-33.
- ▶ Moving the baseline, scrolling, or inverting the trace while frozen clears the displayed results.

In the Cardiac exam, you can perform the following calculations:

Measurements required to complete Cardiac calculations

Note

The following table lists representative calculation results displayed on the clinical monitor. More results may be found in the worksheets and reports.

Table 5-4: Cardiac calculations and results

Calculation list	Measurement name (imaging mode)	Results
EF	EF (2D or M Mode) <ul style="list-style-type: none">▶ LVDd▶ LVDs	EF LVDFS
	LV Vol EF (2D) <ul style="list-style-type: none">▶ A4Cd▶ A4Cs▶ A2Cd▶ A2Cs	A4C EF A2C EF Biplane EF

Table 5-4: Cardiac calculations and results (continued)

Calculation list	Measurement name (imaging mode)	Results
FAC	Right (2D or M Mode) <ul style="list-style-type: none"> ▶ EDA ▶ ESA Left (2D or M Mode) <ul style="list-style-type: none"> ▶ EDA ▶ ESA 	LV FAC RV FAC
IVC	<ul style="list-style-type: none"> ▶ Max D (2D or M Mode) ▶ Min D (2D or M Mode) 	Collapse
LV	Diastole (2D or M Mode) <ul style="list-style-type: none"> ▶ RVWd ▶ RVDd ▶ IVSd ▶ LVDd ▶ LVPWd Systole (2D or M Mode) <ul style="list-style-type: none"> ▶ RVWs ▶ RVDs ▶ IVSs ▶ LVDs ▶ LVPWs 	EF LVDFS
CO	<ul style="list-style-type: none"> ▶ LVOT D (2D) ▶ HR (Doppler) ▶ LVOT VTI (Doppler) 	CO ^a SV

Table 5-4: Cardiac calculations and results (continued)

Calculation list	Measurement name (imaging mode)	Results
Ao/LA	<ul style="list-style-type: none"> ▶ Ao (2D or M Mode) ▶ LA (2D or M Mode) ▶ AAo (2D) ▶ LVOT D (2D) ▶ ACS (M Mode) ▶ LVET (M Mode) 	LA/Ao
MV	<ul style="list-style-type: none"> ▶ E-F Slope (M Mode) ▶ EPSS (M Mode) 	
MV/MR	MV	E:A
	<ul style="list-style-type: none"> ▶ E (Doppler) ▶ Decel (Doppler) ▶ A (Doppler) 	
	▶ PHT (Doppler)	MVA
	▶ VTI (Doppler)	
	▶ IVRT (Doppler)	
	▶ Adur (Doppler)	
	MR	
<ul style="list-style-type: none"> ▶ dP:dT^b (CW Doppler) 		
Area	<ul style="list-style-type: none"> ▶ MVA (2D) ▶ AVA (2D) 	
Atrial Vol	<ul style="list-style-type: none"> ▶ LA A4C (2D) ▶ LA A2C (2D) ▶ RA (2D) 	
LV Mass	<ul style="list-style-type: none"> ▶ Epi (2D) ▶ Endo (2D) ▶ Apical (2D) 	LV Mass

Table 5-4: Cardiac calculations and results (continued)

Calculation list	Measurement name (imaging mode)	Results
AV/LVOT/AI	AV <ul style="list-style-type: none"> ▶ VMax (Doppler) ▶ AV VTI (Doppler) 	AVA ^c by VMax AVAc by VTI
	LVOT <ul style="list-style-type: none"> ▶ VMax (Doppler) ▶ VTI (Doppler) ▶ LVOT D (2D) 	
	AI <ul style="list-style-type: none"> ▶ PHT (Doppler) 	
TV/TR	<ul style="list-style-type: none"> ▶ RA pressure ▶ TR VMax (Doppler) 	RVSP ^d
	<ul style="list-style-type: none"> ▶ E (Doppler) ▶ A (Doppler) 	
	<ul style="list-style-type: none"> ▶ PHT (Doppler) 	TVA
	<ul style="list-style-type: none"> ▶ TV VTI (Doppler) 	
PV	<ul style="list-style-type: none"> ▶ VMax (Doppler) 	
	<ul style="list-style-type: none"> ▶ PV VTI (Doppler) ▶ AT (Doppler) 	AT
P Vein	<ul style="list-style-type: none"> ▶ A (Doppler) ▶ Adur (Doppler) ▶ S (Doppler) ▶ D (Doppler) 	S/D ratio
PISA	<ul style="list-style-type: none"> ▶ Radius (Color) ▶ MR VTI (Doppler) ▶ Ann Diam (2D) ▶ MV VTI (Doppler) 	PISA Area Regurgitant Volume

Table 5-4: Cardiac calculations and results (continued)

Calculation list	Measurement name (imaging mode)	Results
Qp/Qs	<ul style="list-style-type: none"> ▶ LVOT Diam (2D) ▶ RVOT D (2D) ▶ LVOT VTI (Doppler) ▶ RVOT VTI (Doppler) 	Qp/Qs
TDI	Left <ul style="list-style-type: none"> ▶ Sep e' (Doppler) ▶ Sep a' (Doppler) ▶ Lat e' (Doppler) ▶ Lat a' (Doppler) ▶ Inf e' (Doppler) ▶ Inf a' (Doppler) ▶ Ant e' (Doppler) ▶ Ant a' (Doppler) Right <ul style="list-style-type: none"> ▶ s' 	E(MV)/e' ratio ^e
TAPSE	TAPSE (M Mode)	
MAPSE	MAPSE (M Mode)	

^aHR needed for CO. You can enter the HR measurement on the patient form, or by measuring in M Mode or Doppler (see page 5-4).

^bPerformed at 300 cm/s on the negative side of the baseline.

^cThe AVA by VMax measurement requires the LVOT D, LVOT VMax, and AV VMax measurements. The AVA by VTI measurement requires the LVOT D, LVOT VTI, and the AV VTI measurements.

^dUses default RA pressure if not supplied.

^eNeed to measure E (MV measurement) to get E/e' ratio.



To calculate Proximal Isovelocity Surface Area (PISA)

The PISA calculation requires a measurement in 2D, a measurement in Color, and two measurements in Doppler spectral trace. After all measurements are saved, the result appears in the patient report.

1 Measure from Ann D:

- a** On a frozen 2D image, tap **Calcs**.

If this control is hidden, tapping **More Controls** displays it.

- b** On the **PISA** calculation list, tap **Ann D**.
 - c** Position the calipers by dragging.
 - d** Save the calculation: Tap  under the measurement name.
- 2** Measure from Radius:
- a** On a frozen Color image, tap **Calcs**.
 - b** On the **PISA** calculation list, tap **Radius**.
 - c** Position the calipers by dragging.
 - d** Save the calculation: Tap  under the measurement name.
- 3** On a frozen Doppler spectral trace, tap **Calcs**.
- 4** Do the following to measure from MR VTI and again to measure from MV VTI:
- a** On the **PISA** calculation list, tap **MR VTI** or **MV VTI**.
 - b** Drag the caliper to the start of the waveform, and lift your finger to start the trace.
A pencil icon appears.
 - c** Using your finger, trace the waveform.
To make a correction, trace backward on the dotted line.
 - d** Lift your finger to complete the trace.

Note

Even after completing the trace, you can still adjust it by dragging the cursor backward on the dotted line.

- e** Save the calculation: Tap  under the measurement name.

To measure LVDd and LVDs

You may use these measurements to calculate LV volume and ejection fraction (EF).

- 1** On a frozen 2D image or M Mode sweep, tap **Calcs**.
If this control is hidden, tapping **More Controls** displays it.
- 2** On the **EF** or **LV** calculation list, tap the name of the first measurement you want to take.
- 3** Position the calipers by dragging.
- 4** If you want to take additional measurements, tap either of the following and then position the calipers:
 - ▶ **Next** to advance to the next item in the calculation list.

- ▶ The measurement name in the calculation list.

If you need to redo a measurement, select the measurement name and tap .

- 5 Tap  under the measurement name to save the measurement.

To measure End-Diastolic and End-Systolic Areas (EDA and ESA)

You may use these measurements to calculate fractional area change (FAC).

- 1 On a frozen 2D image, tap **Calcs**.

If this control is hidden, tapping **More Controls** displays it.

- 2 On the calculation list, tap **FAC**.

- 3 Do the following for each measurement:

- a Drag the caliper to the desired start position.

After lifting your finger from the screen, a pencil icon appears, indicating that the start location is set and you can begin your trace.

- b Use your finger to trace the area.

To make a correction, trace backward on the dotted line.

- c Complete the trace by lifting your finger from the screen.

The trace closes automatically.

Note

Even after completing the trace, you can still adjust it by dragging the cursor backward on the dotted line.

- d Adjust the trace as needed.

- e To save the calculation, tap  under the measurement name.

To measure Ao, LA, AAO, or LVOT Diam

- 1 On a frozen 2D image or M Mode sweep, tap **Calcs**.

If this control is hidden, tapping **More Controls** displays it.

- 2 On the **Ao/LA** calculation list, tap the measurement name.

- 3 Position the calipers by dragging.

- 4 Save the calculation: Tap  under the measurement name.

To calculate Atrial Volumes (Simpson's Rule)

- 1 On a frozen 2D image, tap **Calcs**.

If this control is hidden, tapping **More Controls** displays it.

- 2 On the calculation list, tap **Atrial Vol**.

- 3 Do the following for each measurement:

- a On the measurements list, tap the desired view and phase.

- b Drag the caliper to the start position at the annulus.

After lifting your finger from the screen, a pencil icon appears, indicating that the start location is set and you can begin your trace.

- c Using your finger, trace the atrial cavity (LA or RA).

To make a correction, trace backward on the dotted line.

- d Complete the trace at the other annulus by lifting your finger from the screen.

The trace closes automatically.

Notes

- ▶ Even after completing the trace, you can still adjust it by dragging the cursor backward on the dotted line.
- ▶ The recommended method is to trace from annulus to annulus and allow the system to automatically close the trace.

- e You can adjust the atrial length by dragging the cursor.

Note

Bi-plane volume is displayed when the length of the cavity as measured in the 2- and 4-chamber views differs by less than 5 mm.

- f To save the calculation, tap under the measurement name.

Note

To calculate LAVI and/or RAVI, BSA is required.

To calculate LV Volume (Simpson's Rule)

Note

To calculate Biplane EF, you will need to make all four measurements.

- 1 On a frozen 2D image, tap **Calcs**.

If this control is hidden, tapping **More Controls** displays it.

- 2 Tap the **EF** calculation list to access the **LV Vol EF** measurements.

- 3 To trace each measurement manually:

- a Under the measurement name, tap the gear icon and select **Manual Trace**.
 - b Position the caliper at the mitral annulus, and lift your finger to start the trace.
A pencil icon appears.
 - c Using your finger, trace the left ventricular (LV) cavity.
To make a correction, trace backward on the dotted line.
 - d Complete the trace at the other annulus by lifting your finger from the screen.
The trace closes automatically.
 - e Adjust ventricle length as needed.
 - f Save the calculation: Tap  under the measurement name.
- 4 To trace each measurement automatically:
- a Under the measurement name, tap the gear icon and select **Border Assist**.
 - b Adjust the calipers so that one is at the mitral annulus, another is at the other annulus, and the third is at the highest point (apex) of the left ventricular (LV) cavity.
 - c Tap on **Trace**.
 - d Once the trace is completed, you may adjust the shape by selecting and dragging the border points.
 - e Adjust ventricle length by dragging the cursors.

Note

Moving the apex of the ventricle length can also be used to adjust the border.

To calculate MV or AV area

- 1 On a frozen 2D image, tap **Calcs**.
If this control is hidden, tapping **More Controls** displays it.
- 2 On the **Area** calculation list, tap **MVA** or **AVA**.
- 3 Drag the caliper to where you want to begin the trace, and lift your finger to start the trace.
- 4 Using your finger, trace the desired area.
To make a correction, trace backward on the dotted line.
- 5 Do one of the following:
 - ▶ To save the measurement and close the trace, tap .
 - ▶ To close the trace, lift your finger.

To calculate LV Mass

- 1 On a frozen 2D image, tap **Calcs**.

If this control is hidden, tapping **More Controls** displays it.

- 2 Do the following for Epi and then for Endo:

- ▶ On the **LV Mass** calculation list, tap the measurement name.
- ▶ Drag the caliper to where you want to begin the trace, and lift your finger to start the trace.
- ▶ Using your finger, trace the desired area.

To make a correction, trace backward on the dotted line.

- 3 Tap  under the measurement name to save the calculation and close the trace.

- 4 On the **LV Mass** calculation list, tap **Apical**.

- 5 Positioning the calipers, measure the ventricular length.

- 6 Save the calculation: Tap  under the measurement name.

To measure Inferior Vena Cava (IVC) Collapse

- 1 On a frozen 2D or M Mode sweep, tap **Calcs**.

If this control is hidden, tapping **More Controls** displays it.

- 2 On the calculation list, tap **IVC**.

- 3 Measure the maximum diameter:

- a Cine the image to show maximum expansion.
- b In the measurements list, tap **Max D**.
- c Measure the diameter with the calipers.
- d To save the measurements, tap  under the measurement name.

- 4 Measure the minimum diameter:

- a Cine the image to show minimum contraction.
- b In the measurements list, tap **Min D**.
- c Measure the diameter with the calipers.
- d To save the measurements, tap  under the measurement name.

To measure deceleration time (Decel)

- 1 On a frozen Doppler spectral trace, tap **Calcs**.
If this control is hidden, tapping **More Controls** displays it.
- 2 On the **MV/MR** calculation list, tap **Decel**.
A caliper appears.
- 3 Drag the active caliper to the first point.
- 4 Drag the other caliper to the second point.
- 5 To save the measurements, tap  under the measurement name.

To measure peak velocity

For each cardiac measurement, the system saves up to five individual measurements and calculates their average. If you take more than five measurements, the most recent measurement replaces the oldest measurement. If you delete a saved measurement from the patient report, the next measurement taken replaces the deleted one in the patient report.

- 1 On a frozen Doppler spectral trace, tap **Calcs**.
If this control is hidden, tapping **More Controls** displays it.
- 2 For each calculation you want to perform, on the calculation list, choose **MV/MR**, **TV/TR**, **TDI**, or **P Vein**, and then do the following:
 - a Tap the measurement name.
 - b Position the calipers.
To make a correction, trace backward on the dotted line.
In some measurements, you can click **Next** to change to the next measurement.
 - c Save the calculation: tap .

To calculate Velocity Time Integral (VTI)

This calculation computes other results in addition to VTI including VMax, PGMax, VMean, and PGMean.

- 1 On a frozen Doppler spectral trace, tap **Calcs**.
If this control is hidden, tapping **More Controls** displays it.
- 2 On the **MV/MR**, **AV/LVOT/AI**, **TV/TR**, or **PV** calculation list, tap **VTI**.
- 3 To trace manually:
 - a Under the measurement name, tap the gear icon and select **Manual Trace**.

- b** Drag the caliper to the start of the waveform, and lift your finger to start the trace.
- c** Using your finger, trace the waveform.
To make a correction, trace backward on the dotted line.
- d** Lift your finger to complete the trace.
- e** Save the calculation: Tap  under the measurement name.

4 To trace automatically:

- a** Under the measurement name, tap the gear icon and select **Auto Measure**.
A vertical caliper appears.
- b** Drag the caliper to the beginning of the waveform.
- c** Drag the second caliper to the end of the waveform and lift your finger.
The measurement results appear.

To calculate Right Ventricular Systolic Pressure (RVSP)

- 1** On a frozen Doppler spectral trace, tap **Calcs**.
If this control is hidden, tapping **More Controls** displays it.
- 2** On the **TV/TR** calculation list, tap **TR VMax**.
- 3** Position the caliper by dragging.
- 4** Save the calculation: Tap  under the measurement name.

Note

This calculation requires the RA pressure. If RA pressure has not been adjusted, the default value is used.

To adjust the RA pressure (RAP)

- 1** On a frozen Doppler spectral trace, tap **Calcs**.
If this control is hidden, tapping **More Controls** displays it.
- 2** On the **TV/TR** calculation list, tap **RAP**.
- 3** Select the desired value from the RA list.

Note

Changing the RA pressure from the default value of 5 MmHG affects the RVSP calculation result.

To calculate Pressure Half Time (PHT) in MV, AI, or TV

- 1 On a frozen Doppler spectral trace, tap **Calcs**.
If this control is hidden, tapping **More Controls** displays it.
- 2 On the **MV/MR**, **AV/LVOT/AI**, or **TV/TR** calculation list, tap **PHT**.
- 3 Drag the first caliper to the peak.
A second caliper appears.
- 4 Position the second caliper:
 - a In MV, drag the caliper along the E-F slope.
 - b In AV, drag the caliper to the end diastole.
- 5 Save the calculation: Tap  under the measurement name.

To calculate Isovolumic Relaxation Time (IVRT)

- 1 On a frozen Doppler spectral trace, tap **Calcs**.
If this control is hidden, tapping **More Controls** displays it.
- 2 On the **MV/MR** calculation list, tap **IVRT**.
A vertical caliper appears.
- 3 Drag the caliper to the aortic valve closure.
A second vertical caliper appears.
- 4 Drag the second caliper to onset of mitral inflow.
- 5 Save the calculation: Tap  under the measurement name.

To calculate Delta Pressure: Delta Time (dP:dT)

To perform the dP:dT measurements, the CW Doppler scale must include velocities of 300 cm/s or greater on the negative side of the baseline (see **“Controls in Doppler”** on page 4-18).

- 1 On a frozen CW Doppler spectral trace, tap **Calcs**.
If this control is hidden, tapping **More Controls** displays it.
- 2 On the **MV/MR** calculation list, tap **dP:dT**.
A horizontal dotted line with an active caliper appears at 100 cm/s.
- 3 Drag the first caliper along the waveform at 100 cm/s.
A second horizontal dotted line with an active caliper appears at 300 cm/s.
- 4 Drag the second caliper along the waveform at 300 cm/s.

5 Save the calculation: Tap  under the measurement name.

To calculate Aortic Valve Area (AVA)

The AVA calculation requires a measurement in 2D and two measurements in Doppler. After the measurements are saved, the result appears in the patient report.

1 In 2D:

a On a frozen 2D image, tap **Calcs**.

If this control is hidden, tapping **More Controls** displays it.

b On the **AV/LVOT/AI** calculation list, tap **LVOT D**.

c Position the calipers by dragging.

d Save the calculation: Tap  under the measurement name.

2 In Doppler, measure either LVOT VMax or LVOT VTI.

▶ **VMax** - In the **AV/LVOT/AI** calculation list, tap **LVOT VMax**, position the caliper by dragging, and then tap  to save the measurement.

▶ **VTI** - In the **AV/LVOT/AI** calculation list, tap **LVOT VTI**, trace the Doppler waveform by dragging, and then tap  to save the measurement.

3 In Doppler, measure either AV VMax or AV VTI

▶ **VMax** - In the **AV/LVOT/AI** calculation list, tap **AV VMax**, position the caliper by dragging, and then tap  to save the measurement.

Note

If VTI is chosen, the VMax value derived from the trace is used as input to the AVA calculation.

▶ **VTI** - In the **AV/LVOT/AI** calculation list, tap **AV VTI**, trace the Doppler waveform by dragging, and then tap  to save the measurement.



Notes

▶ If VTI is chosen, the VMax value derived from the trace is used as input to the AVA calculation.

▶ If VTI measurements are made for both LVOT and AV, a second AVA result is provided.

To calculate Qp/Qs

The Qp/Qs calculation requires two measurements in 2D and two measurements in Doppler. After the measurements are saved, the result appears in the patient report.

- 1 On a frozen 2D image, tap **Calcs**.
If this control is hidden, tapping **More Controls** displays it.
- 2 Do the following to measure from LVOT D and again to measure from RVOT D:
 - a From the **Qp/Qs** calculations list, select **LVOT D** or **RVOT D**.
 - b Position the calipers by dragging.
 - c Save the calculation: Tap  under the measurement name.
- 3 On a frozen Doppler spectral trace, tap **Calcs**.
- 4 Do the following to measure from LVOT VTI and again to measure from RVOT VTI:
 - a From the **Qp/Qs** calculations list, select **LVOT VTI** or **RVOT VTI**.
 - b Select the starting position then lift your finger to start the trace.
 - c Using your finger, trace the waveform.
To make a correction, trace backward on the dotted line.
 - d Lift your finger to complete the trace.
 - e Save the calculation: Tap  under the measurement name.

For information on the automatic trace tool, see **“To measure automatically”** on page 5-7.

To calculate Stroke Volume (SV) or Stroke Index (SI)



The SV and SI calculations require a measurement in 2D and a measurement in Doppler. SI also requires Body Surface Area (BSA). After the measurements are saved, the result appears in the patient report.

- 1 (SI Only) Fill in the **Height** and **Weight** fields on the patient form. The BSA is calculated automatically (see **“Editing patient information”** on page 4-33).
- 2 Measure LVOT diameter:
 - a On a frozen 2D image, tap **Calcs**.
If this control is hidden, tapping **More Controls** displays it.
 - b From the Cardiac Output (CO) calculation list, tap **LVOT D**.
 - c Position the calipers at LVOT by dragging.
 - d Save the calculation: Tap  under the measurement name.
- 3 Measure LVOT VTI using one of the following methods:
 - a From the **AV/LVOT/AI** calculation list, select **VTI** under **LVOT**. Follow the trace instructions in **“To calculate Velocity Time Integral (VTI)”** on page 5-28.

- b** To measure LVOT VTI from the Cardiac Output (CO) calculation list:
 - i** On a frozen Doppler spectral trace, tap **Calcs**.
If this control is hidden, tapping **More Controls** displays it.
 - ii** From the CO calculation list, tap **LVOT VTI**. Follow the trace instructions in **“To calculate Velocity Time Integral (VTI)”** on page 5-28.

To calculate Cardiac Output (CO) or Cardiac Index (CI)

The CO and CI calculations require Stroke Volume and Heart Rate calculations. CI also requires Body Surface Area (BSA). After the measurements are saved, the result appears in the patient report.

- 1** (CI Only) Fill in the **Height** and **Weight** fields on the patient form. The BSA is calculated automatically (see **“Editing patient information”** on page 4-33).
- 2** Calculate LVOT diameter:
 - a** On a frozen 2D image, tap **Calcs**.
If this control is hidden, tapping **More Controls** displays it.
 - b** From the CO calculation list, tap **LVOT D**.
 - c** Position the calipers across the LVOT by dragging.
 - d** To save the measurement, tap  under the measurement name.
- 3** Measure LVOT VTI:
 - a** On a frozen Doppler spectral trace, tap **Calcs**.
If this control is hidden, tapping **More Controls** displays it.
 - b** From the CO calculation list, tap **LVOT VTI**. Follow the trace instructions in **“To calculate Velocity Time Integral (VTI)”** on page 5-28.
- 4** Calculate HR:
 - a** On a frozen Doppler image, tap **Calcs**.
If this control is hidden, tapping **More Controls** displays it.
 - b** On the CO calculations list, tap **HR**.
 - c** Drag the first vertical caliper to the peak of the heartbeat.
A second vertical caliper appears. The active caliper is highlighted green.
 - d** Drag the second vertical caliper to the peak of the next heartbeat.
 - e** To save the measurement, tap  under the measurement name.

To calculate Tricuspid or Mitral Annular Plane Systolic Excursion (TAPSE or MAPSE)

TAPSE is used to determine the state of the right ventricular systolic function and to correlate this measurement with the right ventricular ejection fraction. MAPSE is a similar measurement used to assess left ventricular function.

On a frozen M Mode sweep, tap **Calcs**.

If this control is hidden, tapping **More Controls** displays it.

- 5 Tap **TAPSE** or **MAPSE** from the calculation or measurement list.
- 6 Position the calipers by dragging.
- 7 To save the measurements, tap  under the measurement name.

To measure a Tissue Doppler Imaging (TDI) waveform

- 1 Ensure that TDI is on (see **“Controls in Doppler”** on page 4-18).
- 2 On a frozen Doppler spectral trace, tap **Calcs**.
If this control is hidden, tapping **More Controls** displays it.
- 3 Do the following for each measurement you want to take:
 - a On the TDI calculation list, tap the measurement name.
 - b Position the calipers by dragging.
 - c Save the calculation: Tap  under the measurement name.

Gynecological calculations

WARNINGS

- ▶ To avoid incorrect calculations, verify that the patient information, date, and time settings are accurate.
- ▶ To avoid misdiagnosis or harming the patient outcome, start a new patient form before starting a new patient exam and performing calculations. Starting a new patient form clears the previous patient’s data. The previous patient’s data will be combined with the current patient if the form is not first cleared. See **“Editing patient information”** on page 4-33.

The Gynecological calculations include measurements for uterus, ovaries, and follicles.

In the Gynecological exam, you can also calculate volume (see **“Volume calculation”** on page 5-12).

Measuring uterus

You can measure uterus length (L), width (W), height (H), and endometrial thickness. If you measure length, width, and height, the system also calculates the volume.

To measure uterus

- 1 On the frozen 2D image, tap **Calcs**.

If this control is hidden, tapping **More Controls** displays it.

- 2 On the Uterus list, do the following for each measurement you want to take:

- a In the Uterus list, tap the measurement name.
- b Position the calipers by dragging.
- c Save the measurement.

Measuring ovaries

You can take up to three distance (D) measurements on each ovary. The system also calculates the volume based on the three measurements.

To measure ovaries

- 1 On the frozen 2D image, tap **Calcs**.

If this control is hidden, tapping **More Controls** displays it.

- 2 On the **Ovary** calculation list, do the following for each measurement you want to take:

- a Tap the measurement name under **Right Ovary** or **Left Ovary**.
- b Position the calipers by dragging.
- c Save the measurement.

Measuring follicles

On each side, you can save up to three distance (D) measurements per follicle, for up to ten follicles. The system can display up to eight measurements at once.

If you measure a follicle twice, the average appears in the report. If you measure a follicle three times, the average and a volume calculation appear in the report. Volumes are derived based on one distance, two distance, and three distance measurements.

To measure follicles

- 1 On the frozen 2D image, tap **Calcs**.

If this control is hidden, tapping **More Controls** displays it.

2 On the **Follicle Right** (if measuring the right side) or **Follicle Left** (if measuring the left side) calculation list, do the following for each measurement you want to take:

a Tap the follicle number. If this is the first follicle you are measuring, tap **1**.

b Position the calipers by dragging.

c To measure a second dimension of the same follicle, tap **Next**, or to save just the first measurement, tap  under the follicle number.

A superscripted measurement number appears after the follicle number to indicate the dimension being measured.

d Position the calipers by dragging.

e Tap  under the follicle number to save the first two measurements.

f To measure a third dimension of the same follicle, acquire a new image of the follicle, and then tap the same follicle number.

A superscripted measurement number appears after the follicle number to indicate the dimension being measured.

g Position the calipers by dragging.

h To save the third measurement, tap  under the follicle number.

Obstetrics calculations

WARNINGS

- ▶ Make sure that you have selected the Obstetrics exam type and the OB author for the Obstetrical calculation table you intend to use. See **“Obstetrics calculations settings”** on page 3-7.
- ▶ To avoid incorrect obstetrics calculations, verify with a local clock and calendar that the system’s date and time settings are correct before each use of the system. The system does not automatically adjust for daylight savings time changes.
- ▶ Prior to use, verify that Obstetrical custom table data entries are correct. The system does not confirm the accuracy of the custom table data entered by the user.
- ▶ To avoid incorrect calculations, verify that the patient information, date, and time settings are accurate.
- ▶ To avoid misdiagnosis or harming the patient outcome, start a new patient form before starting a new patient exam and performing calculations. Starting a new patient form clears the previous patient’s data. The previous patient’s data will be combined with the current patient if the form is not first cleared. See **“Editing patient information”** on page 4-33.

In X-Porte, you can calculate gestational age, fetal heart rate, middle cerebral artery, and umbilical artery blood flow velocities. You can select authors for Obstetrical calculations. See **“Obstetrics calculations settings”** on page 3-7 and **“Measurement publications and terminology”** on page 6-3. Estimated Fetal Weight (EFW) is calculated using biparietal diameter (BPD), head circumference (HC), abdominal circumference (AC), and femur length (FL) values that are within range.. If the BPD and HC values are out of range, the system calculates the EFW using only the AC and FL values.

Note

If you change the calculation author during the exam, the common measurements are retained.

Table 5-5: Results from system-defined obstetrical measurements and table authors

Calculation result	Gestational OB measurements	Available authors
Gestational Age (GA) ^a	YS	—
	GS	Hansmann, Nyberg, Tokyo U.
	CRL	Hadlock, Hansmann, Osaka, Tokyo U.
	BPD	Chitty, Hadlock, Hansmann, Osaka, Tokyo U.
	OFD	Hansmann
	HC	Chitty, Hadlock, Hansmann
	TTD	Hansmann, Tokyo U. ^b
	APTD	Tokyo U. ^b
	AC	Hadlock, Hansmann, Tokyo U.
	FTA	Osaka
	FL	Chitty, Hadlock, Hansmann, Osaka, Tokyo U.
	HL	Jeanty
	TL	Jeanty
	Cereb D	—
	CM	—
	Lat Vent	—
Cx Len	—	
Estimated Fetal Weight (EFW) ^c	HC, AC, FL	Hadlock 1
	BPD, AC, FL	Hadlock 2
	AC, FL	Hadlock 3
	BPD, TTD	Hansmann
	BPD, FTA, FL	Osaka U.
	BPD, AC	Shepard
	BPD, TTD, APTD, FL	Tokyo U.

Table 5-5: Results from system-defined obstetrical measurements and table authors

Calculation result	Gestational OB measurements	Available authors
EFW Percentile ^d	EFW, GA	Hadlock
Ratios	HC/AC	Campbell
	FL/AC	Hadlock
	FL/BPD	Hohler
	FL/HC	Hadlock
Amniotic Fluid Index	Q ¹ , Q ² , Q ³ , Q ⁴	Jeng
Cephalic Index	CI	Hadlock
Growth Analysis Tables ^e	BPD	Chitty, Hadlock, Jeanty
	HC	Chitty, Hadlock, Jeanty
	AC	Chitty, Hadlock, Jeanty
	FL	Chitty, Hadlock, Jeanty
	EFW	Brenner, Hadlock, Jeanty
	HC/AC	Campbell

^aThe Gestational Age is automatically calculated and displayed next to the Obstetrical measurement you selected. The average of the results is the AUA. Only measurements of the same type are averaged.

^bFor Tokyo U., APTD and TTD are used only to calculate EFW. No age or growth tables are associated with these measurements.

^cThe Estimated Fetal Weight (EFW) calculation uses an equation that consists of one or more fetal biometry measurements. The author for the Obstetrical tables, which you choose on a system setup page, determines the measurements you must perform to obtain an EFW calculation. Individual selections for Hadlock's EFW equations 1, 2, and 3 are not determined by the user. The selected equation is determined by the measurements that have been saved to the patient report with priority given to the order listed above.

^dGestational Age input range is from 10-40 weeks.

^eThe Growth Analysis tables are used by the Report Graphs feature. Three growth curves are drawn using the table data for the selected growth parameter and published author. Growth tables are available only with a user-entered LMP or EDD.

To measure gestational growth (2D)

For each 2D Obstetrical measurement (except AFI), the system saves up to three individual measurements and their average. If you take more than three measurements, the earliest measurement is deleted.

- 1 Make sure that the Obstetrics exam type is selected.

2 On the patient form, select **LMP** or **EDD**. Select **Twins** if twins.

3 On a frozen 2D image, tap **Calcs**.

If this control is hidden, tapping **More Controls** displays it.

4 Do the following for each measurement you want to take:

a Select the calculation list that contains the measurement.

For twins, there are two sets of calculation lists: Each list in one set is labeled **Twin A**, and each list in the other set is labeled **Twin B**.

b Tap the measurement name.

The caliper tool may change depending on the measurement selected, but the position remains constant.

c Position the calipers by dragging.

d Tap  under the measurement name.

To measure heart rate (M Mode or Doppler)

1 Make sure that the Obstetrics exam type is selected.

2 On a frozen M Mode sweep or Doppler trace, tap **Calcs**.

If this control is hidden, tapping **More Controls** displays it.

3 Tap **HR** on the following calculation list:

▶ For M Mode, the **HR** calculation list (or, if twins, the **Twin A HR** list or **Twin B HR** list).

▶ For Doppler, the **Doppler Measurements** list (or, if twins, the **Twin A Doppler Measurements** list or **Twin B Doppler Measurements** list).

A vertical caliper appears.

4 Drag the vertical caliper to the peak of the heartbeat.

A second vertical caliper appears.

5 Drag the second vertical caliper to the peak of the next heartbeat.

6 Tap  under the measurement name.

To calculate the S/D ratio, RI or PI of the Middle Cerebral Artery (MCA) or Umbilical Artery (UmbA) (Doppler)

1 Make sure that the Obstetrics exam type is selected.

2 On the patient form, select **LMP** or **EDD**. Select **Twins** if twins.

3 On a frozen Doppler spectral trace, tap **Calcs**.

If this control is hidden, tapping **More Controls** displays it.

4 Do the following for each measurement you need to take:

a On the **Doppler Measurements** calculations list, tap the measurement name under **MCA** or **UmbA**.

b Position the calipers:

- ▶ For **S/D, RI**, drag the first caliper to the peak systolic waveform. Tap **Next**, and then drag the second caliper to the end diastole on the waveform.
- ▶ For **S/D, RI, PI**, drag the caliper to the beginning of the desired waveform, and lift your finger to start the trace. Trace the desired area. Lift your finger again to finish the trace.

WARNING | If calipers are positioned imprecisely, the calculation result is inaccurate.

5 Save the calculation.

Only one calculation (**S/D, RI** or **S/D, RI, PI**) can be saved.

Required measurements for MCA or UmbA

Table 5-6: MCA or UmbA calculations and results

Calculation list	Section heading	Measurement name	Results
Doppler Measurements	MCA	▶ S/D, RI	S D S/D RI
		▶ S/D, RI, PI*	S D MDV TAV (or TAP) S/D RI PI
	Umb A	▶ S/D, RI	S D S/D RI
		▶ S/D, RI, PI*	S D MDV TAV (or TAP) S/D RI PI

*Calculation requires a trace measurement.

Related topics

Cardiac calculations	5-18
Calculations settings	3-7
Worksheets and reports	5-50
Acute Care calculations	5-44

Measuring gestational sacs

You can make more than one Gestational Sac measurement on the same frozen image: tap **Next**, make an additional measurement, and then tap .

To make a single Gestational Sac measurement, tap  after the measurement.

Small Parts and MSK calculations



WARNINGS

- ▶ To avoid incorrect calculations, verify that the patient information, date, and time settings are accurate.
- ▶ To avoid misdiagnosis or harming the patient outcome, start a new patient form before starting a new patient exam and performing calculations. Starting a new patient form clears the previous patient's data. The previous patient's data will be combined with the current patient if the form is not first cleared. See ["Editing patient information"](#) on page 4-33.

The Small Parts and MSK calculations include hip angle and hip ratio.

In the Small Parts exam, you can also calculate volume and percent reduction. See ["Volume calculation"](#) on page 5-12 and ["Percent reduction calculations"](#) on page 5-11.

To calculate hip angle

- 1 On a frozen 2D image, tap **Calcs**.
If this control is hidden, tapping **More Controls** displays it.
- 2 Do the following under **Right Hip** and again under **Left Hip**:
 - a Under **Hip Angle**, tap **Baseline**.
A baseline with calipers appears.
 - b Position the baseline by dragging the calipers.
 - c Tap **Line A** (alpha line).
Calipers for Line A appear.
 - d Position Line A by dragging calipers, and tap .
 - e Tap **Line B** (beta line).
Calipers for Line B appear.
 - f Position Line B by dragging calipers, and tap .

To calculate hip ratio

- 1 On a frozen 2D image, tap **Calcs**.
If this control is hidden, tapping **More Controls** displays it.
- 2 Do the following under **Right Hip** and again under **Left Hip**:
 - a Under **d:D Ratio**, tap **Fem Hd** (femoral head).

An ellipse with calipers appears.

b Position and resize the ellipse by dragging its calipers.

c Tap **Baseline**.

The baseline appears automatically.

d Position the baseline by dragging its caliper.

Acute Care calculations

WARNINGS

- ▶ To avoid incorrect calculations, verify that the patient information, date, and time settings are accurate.
- ▶ To avoid misdiagnosis or harming the patient outcome, start a new patient form before starting a new patient exam and performing calculations. Starting a new patient form clears the previous patient's data. The previous patient's data will be combined with the current patient if the form is not first cleared. See ["Editing patient information"](#) on page 4-33.

The Acute Care calculations are part of the licensed Acute Care feature. Results from Acute Care calculations appear in the Acute Care worksheets (see ["Worksheets and reports"](#) on page 5-50).

You can perform any of the following calculations, in any exam type. Distance measurements are in mm.

Table 5-7: Acute Care calculations

Calculation list	Measurement name (imaging mode)
Abdominal Aorta	Maximal aortic diameter (2D)
Obstetrical Pelvic	<ul style="list-style-type: none">▶ Yolk Sac (2D)▶ Gestational Sac (2D)▶ Myometrial Thickness (2D)▶ CRL (2D)^a▶ BPD (2D)^b▶ Fetal HR (M Mode)▶ Adnexa<ul style="list-style-type: none">▶ Right Ovarian Cyst (2D)▶ Left Ovarian Cyst (2D)

Table 5-7: Acute Care calculations (continued)

Calculation list	Measurement name (imaging mode)
Non-Obstetrical Pelvic	<ul style="list-style-type: none">▶ Endometrial Stripe (2D)▶ Uterine Fibroid (2D)▶ Adnexa Right<ul style="list-style-type: none">▶ Ovarian Size (2D)^c<ul style="list-style-type: none">▶ Length▶ Width▶ Height▶ Right Ovarian Cyst▶ Resistive index (Doppler)▶ Adnexa Left<ul style="list-style-type: none">▶ Ovarian Size (2D)^c<ul style="list-style-type: none">▶ Length▶ Width▶ Height▶ Left Ovarian Cyst▶ Resistive index (Doppler)
Biliary	<ul style="list-style-type: none">▶ Gallstone (2D)▶ Gallbladder Wall (2D)▶ CBD (2D)▶ Transverse Gallbladder (2D)▶ Longitudinal Gallbladder (2D)

Table 5-7: Acute Care calculations (continued)

Calculation list	Measurement name (imaging mode)
Renal/Urinary Tract	<ul style="list-style-type: none"> ▶ Right Kidney (2D) <ul style="list-style-type: none"> ▶ Kidney Stone ▶ Renal Cyst ▶ Left Kidney (2D) <ul style="list-style-type: none"> ▶ Kidney Stone ▶ Renal Cyst ▶ Bladder (2D)^c <ul style="list-style-type: none"> ▶ Width ▶ Height ▶ Length
Cardiac	<ul style="list-style-type: none"> ▶ TR VMAx (Doppler) ▶ Aortic Root (2D) ▶ Thoracic Aorta Diameter (2D) ▶ IVC <ul style="list-style-type: none"> ▶ Maximum Diameter (2D) ▶ Minimum Diameter (2D)
Soft Tissue/MSK	<ul style="list-style-type: none"> ▶ Tissue Thickness (2D) ▶ Subcutaneous Collection Diameter (2D)
Ocular	<ul style="list-style-type: none"> ▶ Eye ▶ Right ONSD (2D) ▶ Left ONSD (2D)

^aCalculates a gestational age. See “**Obstetrics calculations**” on page 5-37 for related information.

^bUses the selected gestational age table. See “**Calculations settings**” on page 3-7.

^cVolume is calculated in ML after Length, Width, and Height measurements are taken.

To perform an Acute Care calculation

- 1 On a frozen image, tap **Acute Care**.

If this control is hidden, tapping **More Controls** displays it.

- 2 Do the following for each measurement you want to take:

- a Select the calculation list that contains the measurement.
- b Tap the measurement name.
- c Position the calipers by dragging.

If a Doppler measurement, drag the caliper to a peak systolic waveform, and tap **Next**. A second caliper appears. Drag the second caliper to the end diastole on the waveform.

- d Save the measurement: Tap under the measurement name.

To measure Inferior Vena Cava (IVC) Collapse

See [“To measure Inferior Vena Cava \(IVC\) Collapse”](#) on page 5-27.

Transcranial Doppler and Orbital calculations

WARNINGS

- ▶ To avoid injury to the patient, use only an Orbital (Orb) or Ophthalmic (Oph) exam type when performing imaging through the eye. The FDA has established lower acoustic energy limits for ophthalmic use. The system will not exceed these limits only if the Orbital or Ophthalmic exam type is selected.
- ▶ Verify that the patient information, date, and time settings are accurate.
- ▶ To avoid misdiagnosis or harming the patient outcome, start a new patient form before starting a new patient exam and performing calculations. Starting a new patient form clears the previous patient’s data. The previous patient’s data will be combined with the current patient if the form is not first cleared. See [“Editing patient information”](#) on page 4-33.

The following table shows the measurements available for Transcranial Doppler (TCD) and Orbital (Orb) calculations.

Note

- The system will display ratios of the following velocity measurements:
- ▶ MCA Prox / ECICA
 - ▶ TICA / ECICA
 - ▶ Siphon / ECICA

Table 5-8: Transcranial Doppler and Orbital calculations and results

Calculation list	Measurements	Results
Right Transtemporal	<ul style="list-style-type: none"> ▶ MCA Dist ▶ MCA Mid ▶ MCA Prox ▶ Bifur ▶ ACA ▶ ACoA ▶ TICA ▶ PCAp1 ▶ PCAp2 ▶ PCoA 	Gate depth Velocity* PSV EDV MDV PI RI S/D
Right Transorbital	<ul style="list-style-type: none"> ▶ OA ▶ Siphon 	Gate depth Velocity* PSV EDV MDV PI RI S/D
Right Submandibular	ECICA	Gate depth Velocity* PSV EDV MDV PI RI S/D
Right Suboccipital	<ul style="list-style-type: none"> ▶ FM VA ▶ BA Dist ▶ BA Mid ▶ BA Prox ▶ ECVA 	Gate depth Velocity* PSV EDV MDV PI RI S/D

Table 5-8: Transcranial Doppler and Orbital calculations and results (continued)

Calculation list	Measurements	Results
Left Transtemporal	<ul style="list-style-type: none"> ‣ MCA Dist ‣ MCA Mid ‣ MCA Prox ‣ Bifur ‣ ACA ‣ ACoA ‣ TICA ‣ PCAp1 ‣ PCAp2 ‣ PCoA 	Gate depth Velocity* PSV EDV MDV PI RI S/D
Left Transorbital	<ul style="list-style-type: none"> ‣ OA ‣ Siphon 	Gate depth Velocity* PSV EDV MDV PI RI S/D
Left Submandibular	ECICA	Gate depth Velocity* PSV EDV MDV PI RI S/D
Left Suboccipital	<ul style="list-style-type: none"> ‣ FM VA ‣ BA Dist ‣ BA Mid ‣ BA Prox ‣ ECVA 	Gate depth Velocity* PSV EDV MDV PI RI S/D

*The velocity measurement is labeled either TAM for a manual trace or TAP for an automatic trace .

WARNING

To avoid injury to the patient, use only an Orbital (Orb) or Ophthalmic (Oph) exam type when performing imaging through the eye. The FDA has established lower acoustic energy limits for ophthalmic use. The system will not exceed these limits only if the Orbital or Ophthalmic exam type is selected.

To perform a Transcranial Doppler or Orbital calculation

1 Select the Orbital or Transcranial exam type.

Note

For information about these exam types, see “**Intended use**” on page 2-2

2 On a frozen Doppler spectral trace, tap **Calcs**.

If this control is hidden, tapping **More Controls** displays it.

3 Do the following for each measurement you want to take:

- a From the calculations list, select the measurement.
- b Drag the calipers to position them.
- c To save the calculation, tap  under the measurement name.

Related topics

Worksheets and reports	5-50
Cardiac calculations	5-18
Obstetrics calculations	5-37

Worksheets and reports

The system collects patient information, calculation results, and worksheet findings into a *patient report*. You can view and edit the report preview and worksheets at any time until the exam has ended. After the exam has ended, you can view the patient report (see “**Displaying reports after the exam has ended**” on page 5-54).

The value for a calculation appears in the report only if the calculation is saved. The pound symbol (#) indicates a value that is out of range (for example, too large or small). Calculation values that are out of range are not included in derived calculations (for example, mean). Calculations appear in the order that they were saved.

When you archive or export the exam, the report is included in the exam.

If they are licensed on your system, Acute Care worksheets and MSK worksheets are available. See “**Acute Care and MSK worksheets**” on page 5-53.

Related topics

Reviewing	4-40
DICOM	3-14
Entering patient information	4-33
Printing images	4-43
Acute Care calculations	5-44
Cardiac calculations	5-18
Obstetrics calculations	5-37
Archiving and exporting	4-44

Report preview

To display the report preview

- 1 Tap **WORKSHEETS**.
- 2 (Arterial or Cardiac exam) Tap **Summary** or **Calculations** in the **Report Preview** list. The mean of the detail entries is used in the summary.
You can switch between these views as needed.
To exit the report preview and return to imaging, tap **Done**.

To delete calculation values from the report preview

- 1 Display the report preview.
- 2 (Arterial or Cardiac exam) Tap **Calculations**.
- 3 Select the value, and then tap **Delete**
Deleting some measurements also deletes related measurements. Deleted measurements are not included in the summary information.

To save worksheets as images

- 1 Tap **WORKSHEETS** and display the report preview.
- 2 To save the worksheet:
 - ▶ Tap **Save Image** to save an image of the information displayed on the screen.
 - ▶ Tap **Save Images** to save images of all the worksheet pages.

Arterial reports

To modify the ICA/CCA ratio

- 1 Display the arterial report preview.
- 2 Tap **Summary**.
- 3 Select measurements for the ICA/CCA ratio for both the right and left sides from the **Ratio** list.

Obstetrics reports

The Obstetrics calcs reports have a space for signing printed reports.

To display the Obstetrics Twins report preview

- ❖ In the Obstetrics report preview, do one of the following:
 - ▶ To display an individual twin report preview, tap **Twin A** or **Twin B**.
 - ▶ To display both twins in one report preview, tap **Compare**.

To fill out the Obstetrics anatomy checklist

You can document reviewed anatomy.

- 1 In the Obstetrics report preview, tap **Anatomy Checklist**.
- 2 Do any of the following:
 - ▶ Select the check boxes.
 - ▶ Enter the **Fetal Lie**.
 - ▶ Enter the **Plac Location** and select the grading method (**0, I, II, or III**) from the corresponding list.
 - ▶ Select a **Gender**.

To complete the Obstetrics biophysical profile

- ❖ In the Obstetrics report preview, select values under **Biophysical Profile**.

The total is calculated when values are selected. NST (non-stress test) is optional.

Obstetrics graphs

You can display Obstetrics graphs if the **LMP** or **EDD** text boxes are filled in the patient form, and if a Growth Analysis author has been selected for the measurement (see **“Obstetrics calculations settings”** on page 3-7).

To display Obstetrics graphs

- 1 Tap **WORKSHEETS**.

2 Tap **Graphs**.

3 In the **Graphs** list, select the desired measurement and author.

The graph for the selected measurement appears.

For twins, both measurement sets are plotted on the same graph.

4 (Optional) Tap **Save** to save the current graph page as an image that you can review as part of the exam (see “**Reviewing**” on page 4-40).

5 (Optional) Tap **Print Page** to print the current graph page.

6 Tap **Done** to return to live imaging.

Acute Care and MSK worksheets

Acute Care and MSK (Musculoskeletal) worksheets are licensed features that include patient information, text boxes, and procedure information from the ultrasound system. Acute Care worksheets include results from measurements and calculations you perform from the Acute Care calculation lists.

To display an Acute Care or MSK worksheet

1 Tap **WORKSHEETS**.

2 Tap **Acute Care Worksheets** or **MSK Worksheets**.

3 Tap a worksheet in the list.

To exit the worksheet and return to imaging, tap **Done**.

To edit an Acute Care or MSK worksheet

You can edit worksheets on the system until the exam has ended.

1 Enter information in the worksheet:

▶ **Indications**

▶ (Acute Care worksheets) Select multiple indications, or select **Other Indications** to enter additional information.

▶ (MSK worksheets) Enter indications in the **Indications** text box.

▶ (Acute Care worksheets only) **Views** Select options to reflect the views obtained. Select **Other Views** to enter additional information.

▶ (Acute Care worksheets only) **Findings** You can make multiple selections in the Findings section. Select **Other Findings** to enter additional information.

▶ (Acute Care worksheets only) **Interpretation** You can make multiple selections in the Interpretation section. Select **Other Interpretations** to enter additional information.

- ▶ (MSK worksheets only) **Procedure Details and Conclusions**. You can make multiple selections in the **Procedure Details and Conclusions** section. Enter comments in the **Comments** text box.
- 2 (Acute Care worksheets only) To delete a calculation value, select the value and then tap **Delete**.
 - 3 Tap **Done**.

To customize an Acute Care worksheet

You can customize Acute Care worksheets to show or hide existing fields.

- 1 Tap **More**, then select **System Settings**.
- 2 Tap **Presets** and select **Customize Worksheets**.
- 3 Open up the **Acute Care Worksheets** list and select a specific worksheet.
- 4 Uncheck items to remove them from the worksheet during a procedure. Check items to add them to the worksheet.
- 5 Tap **Done** to save changes.

Printing reports and worksheets

You can print the current page of a report preview or worksheet or the entire report preview or worksheet.

To print a report preview or worksheet

- 1 Display the report preview or worksheet.
- 2 Do one of the following:
 - ▶ To print the entire report preview or worksheet, tap **Print All**.
 - ▶ To print the current page, tap **Print Page**.

Displaying reports after the exam has ended

When you end an exam, the system saves the patient report with all measurements and calculations performed during the exam, including Acute Care or MSK worksheet data, if available.

To display the report after the exam has ended

- 1 Tap **REVIEW**.
- 2 Tap **Patient List**.
- 3 Select an exam.
- 4 Tap **Thumbnails**.

5 Tap **View Report**.

The system displays the read-only report.

6 Tap **Next** and **Prev** to view multiple pages.

7 Tap **Done** to return to the patient list.

Customizing worksheets

You can create up to 12 customizable worksheets. Each worksheet can have up to 20 headings each with three custom text boxes. Custom worksheets cannot be deleted, but can be overwritten.

To create a custom worksheet

1 Tap **More**, then select **System Settings**.

2 Tap **Presets** and select **Customize Worksheets**.

3 Open up the **Custom Worksheets** list and select a blank worksheet.

4 Enter a name for the new worksheet.

5 Enter up to 20 headings (for example, procedures).

6 Enter check box items underneath each heading.

7 Tap **Save Changes** to save changes or **Done** to exit.

Remote worksheets

Remote worksheets is available with license in some countries. The SonoSite X-Porte ultrasound system supports custom remote worksheets created or edited using an ultrasound workflow application, such as SonoSite Synchronicity Workflow Manager or Telexy QPath E. You can import up to 30 remote worksheets from your server to your system, fill out and sign the worksheets on the system, and transfer the remote worksheet data back to the server. Any worksheet data that you enter can be transferred to the DICOM archiver you have set up to work with your workflow application.

The following steps should be completed by a network administrator. See **"DICOM"** on page 3-14 to set up a local DICOM location and access to the server on your system. Refer to the ultrasound workflow application's documentation to set up the server.

To configure access to the remote worksheets server

- 1 Set up a local DICOM location on your ultrasound system, and set **Transfer images** to **End of Exam**.

Notes

- ▶ For the remote worksheet feature to work with static IP configurations, the network needs to be configured with a DNS address.
- ▶ When **Transfer images** is set to **During Exam**, the remote worksheet data will not be transferred to the DICOM device unless an additional image or clip is saved prior to ending exam.

- 2 On your system, set up the server as a DICOM archiver, and select **Include Private Tags** to send remote worksheet data to the archiver.
- 3 Set the server as a secure HTTPS address. You cannot use an unsecured address.
 - a Tap **MORE**, and then tap **System Settings**.
 - b Tap **Administration** in the list on the left.
 - c On the **Administration Login** page, enter your administrator user name and password.
 - d Tap **Login**.
 - e Tap **Remote Worksheets**.

The **Remote Worksheets** page appears.
 - f Enter the address (URL) of the remote server.
 - g Tap **Verify** to verify the address, or **Clear** to clear the field.
 - h Tap **Back** to return to the **Administration** page.
 - i Tap **Done** to exit.

To import remote worksheets

Note

If you are using a QPath E server, you must send a saved image or clip to the server before downloading a remote worksheet for the first time. If you have not sent an image, or clip, the system will indicate a successful worksheet download, but no worksheet will be downloaded.

- 1 On the **Administration Login** settings page, log in as a user with administrative privileges.
- 2 Tap **Remote Worksheets**.

The **Remote Worksheets** page appears.

3 Tap **Synchronize** to download the remote worksheets.

Notes

- ▶ Successfully synchronizing remote worksheets will completely replace the current set of remote worksheets.
- ▶ Tap **Verify** to test the server connection and settings.

4 Tap **OK** once the update is complete. You will return to the **Remote Worksheets** page.

5 Tap **Back** to return to the **Administration** page.

6 Tap **Done** to exit.

To access and complete a remote worksheet

1 Tap **WORKSHEETS**, and then tap **Remote Worksheets** at the bottom of the screen to display the list of remote worksheets.

2 Select a worksheet from the list, and enter your data.

Note

Active worksheets will display an exclamation point.

3 To sign a worksheet, tap **Not Signed** at the top of the worksheet.

On the **WORKSHEETS** page, a check mark appears indicating that the worksheet has been signed.

Note

To be able to sign a worksheet, the worksheet must be configured to include a signature, and the physician **User** ID must be filled out under **Facility** in the patient information form.

4 Tap **Done**.

Notes

- ▶ You must sign each remote worksheet separately.
- ▶ If you are using a QPath E server, at least one image or video clip must be saved for worksheet data to be transferred to the server.

Measuring during review

You can measure images during an exam or during review, after an exam has ended. You must save to obtain an image with measurements added in review. Enable the system to display the **Save Image** or **Save Image & Calcs** control. See [“To configure custom controls”](#) on page 3-35.

Note

Doppler Angle Correct cannot be performed in review.

To measure in review

1 In **Review**, tap the image or video clip that you want to measure. You can only make measurements in full screen:

To view the previous or next image or video clip, tap **Prev** or **Next**.

(Video clips only) Use the scroll arrows, or tap the pause button, and then drag the slider to the frame you want to measure.

2 Select a measurement from the **Calcs** or **Acute Care** menus, or select a basic measurement.

Note

You can only take calculations that are available for the exam type used when capturing the original image.

3 To make a measurement:

- ▶ See **“Measuring”** on page 5-1, to make a basic measurement.
- ▶ See **“Exam-based calculations”** on page 5-13 to make a measurement from the **Calcs** menu.
- ▶ See **“Acute Care calculations”** on page 5-44, to make an acute care measurement.

4 Tap **Save Image** or **Save Image & Calcs** to save an image with your measurements. The original image will remain.

Worksheets can be edited until the report has been generated.

Note

Measurements made in review will always generate a separate report. Review measurements are not added to any measurements made during an exam.

CHAPTER 6

Measurement references

This section provides information about measurement accuracy, publications, and terminology.

Measurement accuracy

The measurements from the system are of a physical property such as distance for evaluation by the clinician. The accuracy values require that you can place the calipers over one pixel. The values do not include acoustic anomalies of the body.

The 2D linear distance measurement results are displayed in centimeters with one place past the decimal point, if the measurement is ten or greater; two places past the decimal point, if the measurement is less than ten.

The linear distance measurement components have the accuracy and range shown in the following tables.

Table 6-1: 2D measurement and calculation accuracy and range

2D measurement	System tolerance ^a	Accuracy by	Test method ^b	Range (cm)
Axial Distance	< ±2% plus 1% of full scale	Acquisition	Phantom	0-26 cm
Lateral Distance	< ±2% plus 1% of full scale	Acquisition	Phantom	0-35 cm
Diagonal Distance	< ±2% plus 1% of full scale	Acquisition	Phantom	0-44 cm
Area ^c	< ±4% plus (2% of full scale/smallest dimension) * 100 plus 0.5%	Acquisition	Phantom	0.01-720 cm ²
Circumference ^d	< ±3% plus (1.4% of full scale/ smallest dimension) * 100 plus 0.5%	Acquisition	Phantom	0.01-96 cm

^aFull scale for distance implies the maximum depth of the image.

^bAn RMI 413a model phantom with 0.7 dB/cm MHz attenuation was used.

^cThe area accuracy is defined using the following equation:

% tolerance = ((1 + lateral error) * (1 + axial error) - 1) * 100 + 0.5%.

^dThe circumference accuracy is defined as the greater of the lateral or axial accuracy and by the following equation:

% tolerance = (√2 (maximum of 2 errors) * 100) + 0.5%.

Table 6-2: M Mode measurement and calculation accuracy and range

M Mode measurement	System tolerance	Accuracy by	Test method	Range
Distance	< +/- 2% plus 1% of full scale ^a	Acquisition	Phantom ^b	0-26 cm
Time	< +/- 2% plus 1% of full scale ^c	Acquisition	Phantom ^d	0.01-10 sec
Heart Rate	< +/- 2% plus (Full Scale ^c * Heart Rate/100)%	Acquisition	Phantom ^d	5-923 bpm

^aFull scale for distance implies the maximum depth of the image.

^bAn RMI 413a model phantom with 0.7 dB/cm MHz attenuation was used.

^cFull scale for time implies the total time displayed on the scrolling graphic image.

^dFUJIFILM SonoSite special test equipment was used.

Table 6-3: PW Doppler mode measurement and calculation accuracy and range

Doppler mode measurement	System tolerance	Accuracy by	Test method ^a	Range
Velocity cursor	< +/- 2% plus 1% of full scale ^b	Acquisition	Phantom	0.01 cm/sec-550 cm/sec
Frequency cursor	< +/- 2% plus 1% of full scale ^b	Acquisition	Phantom	0.01kHz-20.8 kHz
Time	< +/- 2% plus 1% of full scale ^c	Acquisition	Phantom	0.01-10 sec

^aFUJIFILM SonoSite special test equipment was used.

^bFull scale for frequency or velocity implies the total frequency or velocity magnitude, displayed on the scrolling graphic image.

^cFull scale for time implies the total time displayed on the scrolling graphic image.

Sources of measurement errors

In general, two types of errors can be introduced into the measurement:

- ▶ **Acquisition Error:** Includes errors introduced by the ultrasound system electronics relating to signal acquisition, signal conversion, and signal processing for display. Additionally, computational and display errors are introduced by the generation of the pixel scale factor, application of that factor to the caliper positions on the screen, and the measurement display.
- ▶ **Algorithmic Error:** The error introduced by measurements, which are input to higher order calculations. This error is associated with floating-point versus integer-type math, which is subject to errors introduced by rounding versus truncating results for display of a given level of significant digit in the calculation.

Measurement publications and terminology

The following are the publications and terminology used for each calculation result.

Terminology and measurements comply with American Institute of Ultrasound in Medicine (AIUM) published standards.

Cardiac references

Acceleration (ACC) in cm/s^2

Zwibel, W.J. *Introduction to Vascular Ultrasonography*. 4th ed., W.B. Saunders Company, (2000), p.52.

ACC = abs (delta velocity/delta time)

Acceleration Time (AT) in msec

Oh, J.K., Seward, J.B., Tajik, A.J. *The Echo Manual*. 3rd ed., Lippincott, Williams, and Wilkins, (2007), p.147-148.

[time a - time b]

where:

time a = early time;

time b = later time;

only valid when [a] > [b]

Aortic Valve Area (AVA) by Continuity Equation in cm^2

Oh, J.K., Seward, J.B., Tajik, A.J. *The Echo Manual*. 3rd ed., Lippincott, Williams, and Wilkins, (2007), p.73 and p.191-195.

$$A_2 = A_1 * V_1/V_2$$

where:

A_2 = A_o valve area

A_1 = LVOT area;

V_1 = Peak LVOT velocity (VMax) or LVOT VTI

V_2 = Peak A_o valve velocity (VMax) or A_o VTI

LVOT = Left Ventricular Outflow Tract

Body Surface Area (BSA) in m^2

Grossman, W. *Cardiac Catheterization and Angiography*. Philadelphia: Lea and Febiger, (1980), p.90.

$$\text{BSA} = 0.007184 * \text{Weight}^{0.425} * \text{Height}^{0.725}$$

Weight = kilograms

Height = centimeters

Cardiac Index (CI) in l/min/m^2

Oh, J.K., Seward, J.B., Tajik, A.J. *The Echo Manual*. 3rd ed., Lippincott, Williams, and Wilkins, (2007), p.69-70.

$$\text{CI} = \text{CO}/\text{BSA}$$

where:

CO = Cardiac Output
BSA = Body Surface Area

Cardiac Output (CO) in l/min

Oh, J.K., Seward, J.B., Tajik, A.J. *The Echo Manual*. 3rd ed., Lippincott, Williams, and Wilkins, (2007), p.69-70.

$$CO = (SV * HR)/1000$$

where:

CO = Cardiac Output
SV = Stroke Volume (ml)
HR = Heart Rate

Cross Sectional Area (CSA) in cm²

Oh, J.K., Seward, J.B., Tajik, A.J. *The Echo Manual*. 3rd ed., Lippincott, Williams, and Wilkins, (2007), p.70-71.

$$CSA = 0.785 * D^2$$

where: D = diameter of the anatomy of interest

Deceleration Time in msec

Oh, J.K., Seward, J.B., Tajik, A.J. *The Echo Manual*. 3rd ed., Lippincott, Williams, and Wilkins, (2007), p.73-74.

[time a - time b]

where:

time a = time associated with VMax;
time b = when the line tangent to the envelope and through VMax crosses the baseline

Delta Pressure: Delta Time (dP:dT) in mmHg/s

Otto, C.M. *Textbook of Clinical Echocardiography*. 2nd ed., W.B. Saunders Company, (2000), p.117-118.

32 mmHg/time interval in seconds

E:A Ratio in cm/sec

E:A = velocity E/velocity A

E/Ea Ratio

Reynolds, Terry. *The Echocardiographer's Pocket Reference*. 2nd ed., School of Cardiac Ultrasound, Arizona Heart Institute, (2000), p.225.

E Velocity/Ea velocity

where:

E velocity = Mitral Valve E velocity
Ea = annular E velocity, also known as E prime

Effective Regurgitant Orifice (ERO) in mm²

Oh, J.K., Seward, J.B., Tajik, A.J. *The Echo Manual*. 3rd ed., Lippincott, Williams, and Wilkins, (2007), p.73-76, p.210.

$$\text{ERO} = \text{MV Flow Rate} / \text{MR Vel} * 100$$

Ejection Fraction (EF), percent

Oh, J.K., Seward, J.B., Tajik, A.J. *The Echo Manual*. 3rd ed., Lippincott, Williams, and Wilkins, (2007), p.115-116.

$$\text{EF} = [(\text{LVEDV} - \text{LVESV}) / \text{LVEDV}] * 100\%$$

where:

EF = Ejection Fraction

LVEDV = Left Ventricular End Diastolic Volume

LVESV = Left Ventricular End Systolic Volume

Elapsed Time (ET) in msec

ET = time between velocity cursors in milliseconds

FAC (LV)

Dennis, A.T. et al. "Haemodynamics in women with untreated pre-eclampsia." *Anaesthesia*. (2012), 67: p.1105-1118.

$$\text{LV FAC (\%)} = (\text{LV EDA} - \text{LV ESA}) / \text{LV EDA} * 100$$

where:

LV FAC = Left Ventricular Fractional Area Change (%)

LV EDA = Left Ventricular End-diastolic area (cm²)

LV ESA = Left Ventricular End-systolic area (cm²)

FAC (RV)

Lang, R. et al. "Recommendations for Cardiac Chamber quantification by Echocardiography in Adults: An update from the American Society of Echocardiography and European Association of Cardiovascular Imaging." *Journal of the American Society of Echocardiograph*. January (2015), 28: p.1-39.

$$\text{RV FAC (\%)} = (\text{RV EDA} - \text{RV ESA}) / \text{RV EDA} * 100$$

where:

RV FAC = Right Ventricular Fractional Area Change (%)

RV EDA = Right Ventricular End-diastolic area (cm²)

RV ESA = Right Ventricular End-systolic area (cm²)

Heart Rate (HR) in bpm

HR = 3 digit value input by user or measured on M Mode and Doppler image in one heart cycle

Interventricular Septum (IVS) Fractional Thickening, percent

Laurenceau, J. L., Malergue, M.C. *The Essentials of Echocardiography*. Le Hague: Martinus Nijhoff, (1981), p.71.

$$\text{IVSFT} = ((\text{IVSS} - \text{IVSD})/\text{IVSD}) * 100\%$$

where:

IVSS = Interventricular Septal Thickness at Systole
IVSD = Interventricular Septal Thickness at Diastole

Isovolumic Relaxation Time (IVRT) in msec

Oh, J.K., Seward, J.B., Tajik, A.J. *The Echo Manual*. 3rd ed., Philadelphia: Lippincott, Williams, and Wilkins, (2007), p.123-124.

[time a - time b]

where:

time a = mitral valve opening;
time b = aortic valve closure

IVC Percentage Collapse

Lyon, M., Verma, N. "Ultrasound guided volume assessment using inferior vena cava diameter." *The Open Emergency Medicine Journal*. 2010, 3: p.22-24.

$$(\text{IVCd exp} - \text{IVCd insp})/\text{IVCd exp}$$

where:

expiration (exp) = maximum diameter (Max D)
inspiration (insp) = minimum diameter (Min D)

Left Atrium/Aorta (LA/Ao)

Feigenbaum, H. *Echocardiography*. Philadelphia: Lea and Febiger, (1994), p.206, Figure 4-49.

Left Atrial Area

Lopez, L. et al. "Recommendations for quantification methods during the performance of a pediatric echocardiogram: A report from the pediatric measurements writing group of the American Society of Echocardiography pediatric and congenital heart disease council." *Journal of the American Society of Echocardiography*. 2010, 23: p.465-495.

Lang, R. et al. "Recommendations for Cardiac Chamber Quantification by Echocardiography in Adults: An Update from the American Society of Echocardiography and the European Association of Cardiovascular Imaging." *Journal of the American Society of Echocardiography*. (2015), 28: p. 25-26.

Left Atrial Volume

Lang R. et al. "Recommendations for Cardiac Chamber Quantification: A report from the American Society of Echocardiography's Guidelines and Standards Committee and the Chamber Quantification Writing Group, Developed in Conjunction with the European Association of Echocardiography, a Branch of the

European Society of Cardiology." *Journal of the American Society of Echocardiography*. (2005), 18: p.1440-1463.

Lang, R. et al. "Recommendations for Cardiac Chamber quantification by Echocardiography in Adults: An update from the American Society of Echocardiography and European Association of Cardiovascular Imaging." *Journal of the American Society of Echocardiography*. January (2015), 28: p.1-39.

$$LA\ Vol = p/4(h) \Sigma(D1)(D2)$$

where:

- LA Vol = Left Atrial Volume in ml
- h = Height of stacked oval disks making up the LA
- D1 = Orthogonal minor axis
- D2 = Orthogonal major axis

Left Atrial Volume Index

Lang, R., Bierig, M., Devereux, R., et al. "Recommendations for chamber quantification: a report from the American Society of Echocardiography's guidelines and standards committee and the chamber quantification writing group, Developed in conjunction with the European Association of Echocardiography, a branch of the European Society of Cardiology." *Journal of the American Society of Echocardiography*. 2005, 18: p.1440-1463.

Left Ventricular End Volumes (Teichholz) in ml

Teichholz, L.E., Kreulen, T., Herman, et al, M.V. "Problems in echocardiographic volume determinations: echocardiographic-angiographic correlations in the presence or absence of asynergy." *American Journal of Cardiology*. (1976), 37: p.7.

$$LVESV = (7.0 * LVDS^3)/(2.4 + LVDS)$$

where:

- LVESV = Left Ventricular End Systolic Volume
- LVDS = Left Ventricular Dimension at Systole

$$LVEDV = (7.0 * LVDD^3)/(2.4 + LVDD)$$

where:

- LVEDV = Left Ventricular End Diastolic Volume
- LVDD = Left Ventricular Dimension at Diastole

Left Ventricular Mass in gm for 2D

Oh, J.K., Seward, J.B., Tajik, A.J. *The Echo Manual*. 3rd ed., Philadelphia: Lippincott, Williams, and Wilkins, (2007), p.113-114.

$$LV\ Mass = 1.05 * \{[(5/6) * A1 * (a + d + t)] - [(5/6) * A2 * (a + d)]\}$$

where:

- 1.05 = Specific gravity of the myocardium

A1 = Short axis area, diastole (Epi)
 A2 = Short axis area, diastole (Endo)
 a = Long or semi major axis
 d = Truncated semi major axis from the widest short axis diameter to mitral annulus plane.
 t = Myocardial thickness

Left Ventricular Mass in gm for M Mode

Oh, J.K., Seward, J.B., Tajik, A.J. *The Echo Manual*. 3rd ed., Philadelphia: Lippincott, Williams, and Wilkins, (2007), p.115.

$$\text{LV Mass} = 1.04 [(\text{LVID} + \text{PWT} + \text{IVST})^3 - \text{LVID}^3] * 0.8 + 0.6$$

where:

LVID = Internal Dimension
 PWT = Posterior Wall Thickness
 IVST = Interventricular Septal Thickness
 1.04 = Specific gravity of the myocardium
 0.8 = Correction factor

Left Ventricular Volume: Biplane Method in ml

Schiller, N.B., Shah, P.M., Crawford, M., et al. "Recommendations for Quantitation of the Left Ventricle by Two-Dimensional Echocardiography." *Journal of American Society of Echocardiography*. September-October 1989, 2: p.362.

$$V = \left(\frac{\pi}{4}\right) \sum_{i=1}^n a_i b_i \left(\frac{L}{n}\right)$$

Simpson's method is used to model the chamber as a stack of elliptical disks.

where:

V = Volume in ml
 a_i = Diameter of major axis of elliptical disk *i* in mm
 b_i = Diameter of minor axis of elliptical disk *i* in mm
 n = Number of disks (n=20)
 L = Length of the chamber
 i = Disk index

Left Ventricular Volume: Single Plane Method in ml

Schiller, N.B., Shah, P.M., Crawford, M., et al. "Recommendations for Quantitation of the Left Ventricle by Two-Dimensional Echocardiography." *Journal of American Society of Echocardiography*. September-October 1989, 2: p.362.

$$V = \left(\frac{\pi}{4}\right) \sum_{i=1}^n a_i^2 \left(\frac{L}{n}\right)$$

Simpson's method is used to model the chamber as a stack of circular disks.

where:

V = Volume

a_i = Diameter of disk i in mm

n = Number of disks (n=20)

L = Length of chamber, measured from the midpoint of the line connecting the two opposite sides of the mitral ring and the most distant point (apex) of the chamber contour

i = Disk index

Left Ventricular Dimension (LVD) Fractional Shortening, percent

Oh, J.K., Seward, J.B., Tajik, A.J. *The Echo Manual*. 3rd ed., Philadelphia: Lippincott, Williams, and Wilkins, (2007), p.115.

$$\text{LVDFS} = [(\text{LVDD} - \text{LVDS})/\text{LVDD}] * 100\%$$

where:

LVDD = Left Ventricle Dimension at Diastole

LVDS = Left Ventricle Dimension at Systole

LV Ejection Fraction

Schiller, N.B., Shah, P.M., Crawford, M., et al. "Recommendations for Quantification of the Left Ventricle by Two-Dimensional Echocardiography." *Journal of American Society of Echocardiography*. September-October 1989, 2: p.364.

$$\text{EF} = ((\text{End Diastolic Volume} - \text{End Systolic Volume})/\text{End Diastolic Volume}) * 100 (\%).$$

Left Ventricular Posterior Wall Fractional Thickening (LVPWFT), percent

Laurenceau, J. L., Malergue, M.C. *The Essentials of Echocardiography*. Le Hague: Martinus Nijhoff, (1981), p.71.

$$\text{LVPWFT} = [(\text{LVPWS} - \text{LVPWD})/\text{LVPWD}] * 100\%$$

where:

LVPWS = Left Ventricular Posterior Wall Thickness at Systole

LVPWD = Left Ventricular Posterior Wall Thickness at Diastole

MAPSE

Matos, J., Kronzon, I., et al. "Mitral Annular Plane Systolic Excursion as a Surrogate for Left Ventricular Ejection Fraction." *Journal of the American Society of Echocardiography*. (2012), p.969-974.

M Mode distance measurement of systolic excursion of the left ventricle.

Mean Velocity (VMean) in cm/s

VMean = mean velocity

Mitral Valve Area (MVA) in cm²

Oh, J.K., Seward, J.B., Tajik, A.J. *The Echo Manual*. 3rd ed., Philadelphia: Lippincott, Williams, and Wilkins, (2007), p.73-74.

MVA = 220/PHT

where: PHT = pressure half time

220 is an empirical derived constant and may not accurately predict mitral valve area in mitral prosthetic heart valves. The mitral valve area continuity equation may be utilized in mitral prosthetic heart valves to predict effective orifice area.

MV Flow Rate in cc/sec

Oh, J.K., Seward, J.B., Tajik, A.J.. *The Echo Manual*. 3rd ed., Philadelphia: Lippincott, Williams, and Wilkins, (2007), p.73-76, p.210.

Flow = PISA * Va

where:

PISA = Proximal Isovelocity Surface Area

Va = aliasing Velocity

Pressure Gradient (PG) in mmHG

Baumgartner, H., Hung, J., Bermejo, J., et al. "Echocardiographic Assessment of Valve Stenosis: EAE/ASE Recommendations for Clinical Practice". *Journal of American Society of Echocardiography*. January 2009, p. 4-5.

PG = 4 * (Velocity)² (velocity units must be meters/second)

Peak E Pressure Gradient (E PG)

E PG = 4 * PE²

Peak A Pressure Gradient (A PG)

A PG = 4 * PA²

Peak Pressure Gradient (PGMax)

PGMax = 4 * VMax²

Mean Pressure Gradient (PGMean)

PGMean = Average pressure gradient during the flow period

Pressure Half Time (PHT) in msec

Oh, J.K., Seward, J.B., Tajik, A.J. *The Echo Manual*. 3rd ed., Philadelphia: Lippincott, Williams, and Wilkins, (2007), p.73-74.

Reynolds, Terry. *The Echocardiographer's Pocket Reference*. 2nd ed., School of Cardiac Ultrasound, Arizona Heart Institute, (2000), p. 391.

$PHT = DT * 0.29$ (time required for the pressure gradient to fall half its maximum level)

where:

DT = deceleration time

Proximal Isovelocity Surface Area (PISA) in cm²

Oh, J.K., Seward, J.B., Tajik, A.J. *The Echo Manual*. 3rd ed., Philadelphia: Lippincott, Williams, and Wilkins, (2007), p.74-76.

$PISA = 2 \pi r^2$

where:

r = aliasing radius

Qp/Qs

Oh, J.K., Seward, J.B., Tajik, A.J. *The Echo Manual*. 3rd ed., Philadelphia: Lippincott, Williams, and Wilkins, (2007), p.70-72.

$Qp/Qs = SV_{Qp\ site} / SV_{Qs\ site} = RVOT\ SV / LVOT\ SV$

where:

$RVOT\ SV = RVOT\ CSA * RVOT\ VTI = \pi/4 * RVOT\ diameter^2 * RVOT\ VTI$

$LVOT\ SV = LVOT\ CSA * LVOT\ VTI = \pi/4 * LVOT\ diameter^2 * LVOT\ VTI$

Regurgitant Fraction (RF) in percent

Oh, J.K., Seward, J.B., Tajik, A.J. *The Echo Manual*. 3rd ed., Philadelphia: Lippincott, Williams, and Wilkins, (2007), p.215-217.

$RF = RV / MV\ SV$

where:

RV = Regurgitant Volume

MV SV = Mitral Stroke Volume (Mitral CSA * Mitral VTI)

Mitral CSA = cross-sectional area calculated using annulus diameter

Regurgitant Volume (RV) in cc

Oh, J.K., Seward, J.B., Tajik, A.J. *The Echo Manual*. 3rd ed., Lippincott, Williams, and Wilkins, (2007), p.215-217.

$$RV = ERO * MR VTI/100$$

Right Atrial Volume

Lang, R., Bierig, M., Devereux, R., et al. "Recommendations for chamber quantification: a report from the American Society of Echocardiography's guidelines and standards committee and the chamber quantification writing group, Developed in conjunction with the European Association of Echocardiography, a branch of the European Society of Cardiology." *Journal of the American Society of Echocardiograph*. 2005, 18: p.1440-1463.

$$RA Vol = \pi/4(h) \Sigma(D1)^2$$

where:

RA Vol = Right Atrial Volume in ml

h = Height of stacked circular disks making up the RA

D1 = Orthogonal minor axis

Right Atrial Volume Index

Wang, Y., Gutman, J., et al. "Atrial volume in a normal adult population by two-dimensional echocardiography." *Chest*. (1984), 86: p.595-601.

$$RA Vol Index = RA Vol/BSA (ml/L2)$$

Right Ventricular Systolic Pressure (RVSP) in mmHg

Oh, J.K., Seward, J.B., Tajik, A.J. *The Echo Manual*. 3rd ed., Philadelphia: Lippincott, Williams, and Wilkins, (2007), p.66.

$$RVSP = 4 * (VMax TR)^2 + RAP$$

where:

RAP = Right Atrial Pressure

S/D

Reynolds, Terry. *The Echocardiographer's Pocket Reference*. 2nd ed., School of Cardiac Ultrasound, Arizona Heart Institute, (2000), p.217.

S velocity/D velocity

where:

S velocity = Pulmonary vein S wave

D velocity= Pulmonary vein D wave

Stroke Index (SI) in cc/m²

Mosby's Medical, Nursing, & Allied Health Dictionary, 4th ed., (1994), p.1492.

$$SI = SV/BSA$$

where:

SV = Stroke Volume

BSA = Body Surface Area

Stroke Volume (Doppler) in ml

Oh, J.K., Seward, J.B., Tajik, A.J. *The Echo Manual*. 3rd ed., Philadelphia: Lippincott, Williams, and Wilkins, (2007), p.69-71.

$$SV = (CSA * VTI)$$

where:

CSA = Cross Sectional Area of the orifice (LVOT area)

VTI = Velocity Time Integral of the orifice

Stroke Volume (2D and M Mode) in ml

Oh, J.K., Seward, J.B., Tajik, A.J. *The Echo Manual*. 2nd ed., Boston: Little, Brown and Company, (1994), p.44.

$$SV = (LVEDV - LVESV)$$

where:

SV = Stroke Volume

LVEDV = End Diastolic Volume

LVESV = End Systolic Volume

TAPSE

Rudski, L., Lai, W., et al. "Guidelines for the echocardiographic assessment of the right heart in adults: a report from the American Society of Echocardiography." *Journal of the American Society of Echocardiograph*. (2010), p.685-713.

M Mode distance measurement of systolic excursion of the right ventricle.

Tricuspid Valve Area (TVA)

Oh, J.K., Seward, J.B., Tajik, A.J. *The Echo Manual*. 3rd ed., Philadelphia: Lippincott, Williams, and Wilkins, (2007), p.73-74.

$$TVA = 220 / PHT$$

Velocity Time Integral (VTI) in cm

Reynolds, Terry. *The Echocardiographer's Pocket Reference*. 2nd ed., School of Cardiac Ultrasound, Arizona Heart Institute, (2000), p.383.

VTI = absolute peak velocities integrated between two points in time, expressed in units of cm.

When using **Auto Measure**, VTI is always based on the peak trace and represents the distance (cm) that blood travels in the time interval represented by the delimiters (presumably an ejection period).

Obstetrical references

Amniotic Fluid Index (AFI)

Jeng, C. J. et al. "Amniotic Fluid Index Measurement with the Four Quadrant Technique During Pregnancy." *The Journal of Reproductive Medicine*, 35:7 (July 1990), p.674-677.

Average Ultrasound Age (AUA)

The system provides an AUA derived from the component measurements from the measurement tables.

Cephalic Index (CI)

Hadlock, F.P., Deter, R.L., Carpenter, R.J., and Park, S.K. "Estimating Fetal Age: Effect of Head Shape on BPD," *AJR* (1981),137:p. 83-85.

Estimated Date of Delivery (EDD) by Average Ultrasound Age (AUA)

Results are displayed as month/day/year.

EDD = system date + (280 days – AUA in days)

Estimated Date of Delivery (EDD) by Last Menstrual Period (LMP)

The date entered into the patient information for LMP must precede the current date.

Results are displayed as month/day/year.

EDD = LMP date + 280 days

Estimated Fetal Weight (EFW)

Hadlock, F. et al. "Estimation of Fetal Weight with the Use of Head, Body, and Femur Measurements, A Prospective Study." *American Journal of Obstetrics and Gynecology*, 151:3 (February 1, 1985), p.333-337.

Hansmann, M. et al. *Ultrasound Diagnosis in Obstetrics and Gynecology*. New York: Springer-Verlag, (1986), p.154.

Osaka University. *Ultrasound in Obstetrics and Gynecology*. (July 20, 1990), p.103-105.

Shepard M.J., Richards, V. A., Berkowitz, R. L., et al. "An Evaluation of Two Equations for Predicting Fetal Weight by Ultrasound." *American Journal of Obstetrics and Gynecology*, 142:1 (January 1, 1982), p.47-54.

University of Tokyo, Shinozuka, N. FJSUM, et al. "Standard Values of Ultrasonographic Fetal Biometry." *Japanese Journal of Medical Ultrasonics*, 23:12 (1996), p. 880, Equation 1.

EFW Percentile

Hadlock, F., Harrist R.B., Martinex-Poyer, J., "In-utero Analysis of Fetal Growth: A Sonographic Weight Standard", *Radiology* 181 (1991), p. 129-133 (Table1).

Gestational Age (GA) by Last Menstrual Period (LMP)

The gestational age derived from the LMP date entered on the patient form.

Results are displayed in weeks and days, and is calculated as follows:

$GA(LMP) = \text{System date} - \text{LMP date}$

Gestational Age (GA) by Last Menstrual Period (LMPd) Derived from Established Due Date (EDD)

Same as GA by EDD.

The gestational age derived from the system derived LMP using the Established Due Date entered on the patient form.

Results are displayed in weeks and days, and is calculated as follows:

$GA(LMPd) = \text{System Date} - \text{LMPd}$

Last Menstrual Period Derived (LMPd) by Established Due Date (EDD)

Results are displayed as month/day/year.

$LMPd(\text{Estab. DD}) = \text{Estab. DD} - 280 \text{ days}$

Gestational age tables

Abdominal Circumference (AC)

Hadlock, F., et al. "Estimating Fetal Age: Computer-Assisted Analysis of Multiple Fetal Growth Parameters." *Radiology*, 152: (1984), p.497-501.

Hansmann, M., et al. *Ultrasound Diagnosis in Obstetrics and Gynecology*. New York: Springer-Verlag, (1986), p.431.

University of Tokyo, Shinozuka, N. FJSUM, et al. "Standard Values of Ultrasonographic Fetal Biometry." *Japanese Journal of Medical Ultrasonics*, 23:12 (1996), p.885.

WARNING

The gestational age calculated by your FUJIFILM SonoSite system does not match the age in the aforementioned reference at the 20.0 cm and 30.0 cm abdominal circumference (AC) measurements. The implemented algorithm extrapolates the gestational age from the slope of the curve of all table measurements, rather than decreasing the gestational age for a larger AC measurement indicated in the referenced table. This results in the gestational age always increasing with an increase in AC.

Biparietal Diameter (BPD)

Chitty, L. S. and Altman, D.G. "New charts for ultrasound dating of pregnancy." *Ultrasound in Obstetrics and Gynecology* 10: (1997), p.174-179, Table 3.

Hadlock, F., et al. "Estimating Fetal Age: Computer-Assisted Analysis of Multiple Fetal Growth Parameters." *Radiology*, 152: (1984), p.497-501.

Hansmann, M., et al. *Ultrasound Diagnosis in Obstetrics and Gynecology*. New York: Springer-Verlag, (1986), p.440.

Osaka University. *Ultrasound in Obstetrics and Gynecology*. (July 20, 1990), p.98.

University of Tokyo, Shinozuka, N. FJSUM, et al. "Standard Values of Ultrasonographic Fetal Biometry." *Japanese Journal of Medical Ultrasonics*, 23:12 (1996), p.885.

Cisterna Magna (CM)

Mahony, B., Callen, P., Filly, R., and Hoddick, W. "The fetal cisterna magna." *Radiology*, 153: (December 1984), p.773-776.

Crown Rump Length (CRL)

Hadlock, F., et al. "Fetal Crown-Rump Length: Re-evaluation of Relation to Menstrual Age (5-18 weeks) with High-Resolution, Real-Time Ultrasound." *Radiology*, 182: (February 1992), p.501-505.

Hansmann, M., et al. *Ultrasound Diagnosis in Obstetrics and Gynecology*. New York: Springer-Verlag, (1986), p.439.

Osaka University. *Ultrasound in Obstetrics and Gynecology*. (July 20, 1990), p.20 and p.96.

Tokyo University. "Gestational Weeks and Computation Methods." *Ultrasound Imaging Diagnostics*, 12:1 (1982-1), p.24-25, Table 3.

Femur Length (FL)

Chitty, L. S. and Altman, D.G. "New charts for ultrasound dating of pregnancy." *Ultrasound in Obstetrics and Gynecology* 10: (1997), p.174-179, Table 8, 186.

Hadlock, F., et al. "Estimating Fetal Age: Computer-Assisted Analysis of Multiple Fetal Growth Parameters." *Radiology*, 152: (1984), p.497-501.

Hansmann, M., et al. *Ultrasound Diagnosis in Obstetrics and Gynecology*. New York: Springer-Verlag, (1986), p.31.

Osaka University. *Ultrasound in Obstetrics and Gynecology*. (July 20, 1990), p.01-102.

University of Tokyo, Shinozuka, N. FJSUM, et al. "Standard Values of Ultrasonographic Fetal Biometry." *Japanese Journal of Medical Ultrasonics*, 23:12 (1996), p.886.

Fetal Trunk Cross-Sectional Area (FTA)

Osaka University. *Ultrasound in Obstetrics and Gynecology*. (July 20, 1990), p.99-100.

Gestational Sac (GS)

Hansmann, M., et al. *Ultrasound Diagnosis in Obstetrics and Gynecology*. New York: Springer-Verlag, (1986).

Nyberg, D.A., et al. "Transvaginal Ultrasound." *Mosby Yearbook*, (1992), p.76.

Gestational sac measurements provide a fetal age based on the mean of one, two, or three distance measurements; however, Nyberg's gestational age equation requires all three distance measurements for an accurate estimate.

Tokyo University. "Gestational Weeks and Computation Methods." *Ultrasound Imaging Diagnostics*, 12:1 (1982-1).

Head Circumference (HC)

Chitty, L. S. and Altman, D.G. "New charts for ultrasound dating of pregnancy." *Ultrasound in Obstetrics and Gynecology* 10: (1997), 174-191, Table 5, p.182.

Hadlock, F., et al. "Estimating Fetal Age: Computer-Assisted Analysis of Multiple Fetal Growth Parameters." *Radiology*, 152: (1984), p.497-501.

Hansmann, M., et al. *Ultrasound Diagnosis in Obstetrics and Gynecology*. New York: Springer-Verlag, (1986), p.431.

Humerus (HL)

Jeanty, P., Rodesch, F., Delbeke, D., Dumont, J. E. "Estimate of Gestational Age from Measurements of Fetal Long Bones." *Journal of Ultrasound in Medicine*. 3: (February 1984), p.75-79

Occipito-Frontal Diameter (OFD)

Hansmann, M., et al. *Ultrasound Diagnosis in Obstetrics and Gynecology*. New York: Springer-Verlag, (1986), p.431.

Tibia

Jeanty, P., Rodesch, F., Delbeke, D., Dumont, J. E. "Estimate of Gestational Age from Measurements of Fetal Long Bones." *Journal of Ultrasound in Medicine*. 3: (February 1984), p.75-79.

Transverse Trunk Diameter (TTD)

Hansmann, M., et al. *Ultrasound Diagnosis in Obstetrics and Gynecology*. New York: Springer-Verlag, (1986), p.431.

Growth analysis tables

Abdominal Circumference (AC)

Chitty, Lyn S. et al. "Charts of Fetal Size: 3. Abdominal Measurements." *British Journal of Obstetrics and Gynaecology*, 101: (February 1994), p.131, Appendix: AC-Derived.

Hadlock, F., et al. "Estimating Fetal Age: Computer-Assisted Analysis of Multiple Fetal Growth Parameters." *Radiology*, 152: (1984), p.497-501.

Jeanty P., Cousaert, E., and Cantraine, F. "Normal Growth of the Abdominal Perimeter." *American Journal of Perinatology*, 1: (January 1984), p.129-135.(Also published in Hansmann, Hackeloer, Staudach, Wittman. *Ultrasound Diagnosis in Obstetrics and Gynecology*. Springer-Verlag, New York, (1986), p.179, Table 7.13.)

Biparietal Diameter (BPD)

Chitty, Lyn S. et al. "Charts of Fetal Size: 2. Head Measurements." *British Journal of Obstetrics and Gynaecology*, 101: (January 1994), p.43, Appendix: BPD-Outer-Inner.

Hadlock, F., et al. "Estimating Fetal Age: Computer-Assisted Analysis of Multiple Fetal Growth Parameters." *Radiology*, 152: (1984), p.497-501.

Jeanty P., Cousaert, E., and Cantraine, F. "A Longitudinal Study of Fetal Limb Growth." *American Journal of Perinatology*, 1: (January 1984), p.136-144, Table 5.

(Also published in Hansmann, Hackeloer, Staudach, Wittman. *Ultrasound Diagnosis in Obstetrics and Gynecology*. Springer-Verlag, New York, (1986), p.176, Table 7.8.)

Estimated Fetal Weight (EFW)

Brenner, William E., Edelman, D. A. Hendricks, C. H. "A standard of fetal growth for the United States of America," *American Journal of Obstetrics and Gynecology*, 126: 5 (November 1, 1976), p.555-564; Table II.

Hadlock F., et al. "In Utero Analysis of Fetal Growth: A Sonographic Weight Standard." *Radiology*, 181: (1991), p.129-133.

Jeanty, Philippe, F. Cantraine, R. Romero, E. Cousaert, and Hobbins, J. "A Longitudinal Study of Fetal Weight Growth." *Journal of Ultrasound in Medicine*, 3: (July 1984), p.321-328, Table 1.(Also published in Hansmann, Hackeloer, Staudach, and Wittman. *Ultrasound Diagnosis in Obstetrics and Gynecology*. Springer-Verlag, New York, (1986), p.186, Table 7.20.)

Femur Length (FL)

Chitty, Lyn S. et al. "Charts of Fetal Size: 4. Femur Length." *British Journal of Obstetrics and Gynaecology*, 101: (February 1994), p.135.

Hadlock, F., et al. "Estimating Fetal Age: Computer-Assisted Analysis of Multiple Fetal Growth Parameters." *Radiology*, 152: (1984), p.497-501.

Jeanty P, Cousaert, E., and Cantraine, F. "A Longitudinal Study of Fetal Limb Growth." *American Journal of Perinatology*, 1: (January 1984), p.136-144, Table 5.

(Also published in Hansmann, Hackeloer, Staudach, Wittman. *Ultrasound Diagnosis in Obstetrics and Gynecology*. Springer-Verlag, New York, (1986), p.182, Table 7.17.)

Head Circumference (HC)

Chitty, Lyn S., et al. "Charts of Fetal Size: 2. Head Measurements." *British Journal of Obstetrics and Gynaecology*, 101: (January 1994), p.43, Appendix: HC-Derived.

Hadlock, F., et al. "Estimating Fetal Age: Computer-Assisted Analysis of Multiple Fetal Growth Parameters." *Radiology*, 152: (1984), p.497-501.

Jeanty P, Cousaert, E., and Cantraine, F. "A longitudinal study of Fetal Head Biometry." *American J of Perinatology*, 1: (January 1984), p.118-128, Table 3.

(Also published in Hansmann, Hackeloer, Staudach, Wittman. *Ultrasound Diagnosis in Obstetrics and Gynecology*. Springer-Verlag, New York, (1986), p.176, Table 7.8.)

Head Circumference (HC)/Abdominal Circumference (AC)

Campbell S., Thoms Alison. "Ultrasound Measurements of the Fetal Head to Abdomen Circumference Ratio in the Assessment of Growth Retardation," *British Journal of Obstetrics and Gynaecology*, 84: (March 1977), p.165-174.

Ratio calculations

FL/AC Ratio

Hadlock F.P., Deter, R. L., Harrist, R. B., Roecker, E., and Park, S.K. "A Date Independent Predictor of Intrauterine Growth Retardation: Femur Length/Abdominal Circumference Ratio," *American Journal of Roentgenology*, 141: (November 1983), p.979-984.

FL/BPD Ratio

Hohler, C.W., and Quetel, T.A. "Comparison of Ultrasound Femur Length and Biparietal Diameter in Late Pregnancy," *American Journal of Obstetrics and Gynecology*, 141:7 (Dec. 1 1981), p.759-762.

FL/HC Ratio

Hadlock F.P., Harrist, R. B., Shah, Y., and Park, S.K. "The Femur Length/Head Circumference Relation in Obstetric Sonography." *Journal of Ultrasound in Medicine*, 3: (October 1984), p.439-442.

HC/AC Ratio

Campbell S., Thoms Alison. "Ultrasound Measurements of the Fetal Head to Abdomen Circumference Ratio in the Assessment of Growth Retardation," *British Journal of Obstetrics and Gynaecology*, 84: (March 1977), p.165-174.

General references

+/x or S/D Ratio

$+/x = (\text{Velocity A}/\text{Velocity B})$

where:

A = velocity cursor +

B = velocity cursor x

Acceleration Index (ACC)

Zwiebel, W.J. *Introduction to Vascular Ultrasonography*, 4th ed., W.B. Saunders Company, (2000), p.52.

ACC = abs (delta velocity/delta time)

Elapsed Time (ET)

ET = time between velocity cursors in milliseconds

Hip Angle/d:D Ratio

Graf, R. "Fundamentals of Sonographic Diagnosis of Infant Hip Dysplasia." *Journal of Pediatric Orthopedics*, Vol. 4, No. 6: p.735-740, 1984.

Morin, C., Harcke, H., MacEwen, G. "The Infant Hip: Real-Time US Assessment of Acetabular Development." *Radiology* 177: p.673-677, December 1985.

Percent Area Reduction

Taylor K.J.W., Burns, P.N., Breslau, P. *Clinical Applications of Doppler Ultrasound*, Raven Press, N.Y., (1988), p.130-136.

Zwiebel W.J., Zagzebski, J.A., Crummy, A.B., et al. "Correlation of peak Doppler frequency with lumen narrowing in carotid stenosis." *Stroke*, 3: (1982), p.386-391.

$\% \text{ Area Reduction} = [1 - A2(\text{cm}^2)/A1(\text{cm}^2)] * 100$

where:

A1 = original area of the vessel in square cm

A2 = reduced area of the vessel in square cm

Percent Diameter Reduction

Handa, Nobuo et al., "Echo-Doppler Velocimeter in the Diagnosis of Hypertensive Patients: The Renal Artery Doppler Technique," *Ultrasound in Medicine and Biology*, 12:12 (1986), p.945-952.

$$\% \text{ Diameter Reduction} = [1 - D2(\text{cm})/D1(\text{cm})] * 100$$

where:

D1 = original diameter of the vessel in cm

D2 = reduced diameter of the vessel in cm

Pressure Gradient (PG) in mmHG

Oh, J.K., Seward, J.B., Tajik, A.J. *The Echo Manual*. 2nd ed., Lippincott, Williams, and Wilkins, (1999), p.64.

$$PG = 4 * (\text{Velocity})^2 \text{ (velocity units must be meters/second)}$$

Peak E Pressure Gradient (E PG)

$$E \text{ PG} = 4 * PE^2$$

Peak A Pressure Gradient (A PG)

$$A \text{ PG} = 4 * PA^2$$

Peak Pressure Gradient (PGMax)

$$PGMax = 4 * VMax^2$$

Mean Pressure Gradient (PGMean)

$$PGMean = 4 * VMax^2 \text{ (average pressure gradient during the flow period)}$$

Pulsatility Index (PI)

Kurtz, A.B., Middleton, W.D. *Ultrasound-the Requisites*. Mosby Year Book, Inc., (1996), p.469.

$$PI = (PSV - EDV)/V$$

where:

PSV = peak systolic velocity

EDV = end diastolic velocity

V = mean flow velocity throughout the entire cardiac cycle

Note

When using **Auto Measure**, the mean flow velocity is TAP (Time Average Peak).

Zwiebel, W. J. *Introduction to Vascular Ultrasonography*. 6th Edition, W.B. Saunders Company, 2012.

$$PI = (PSV - MDV) / V \text{ (no units)}$$

where:

PSV = peak systolic velocity

MDV = Minimum diastolic velocity

V = TAP (Time Averaged Peak) flow velocity throughout the cardiac cycle

Resistive Index (RI)

Kurtz, A.B., Middleton, W.D. *Ultrasound—the Requisites*. Mosby Year Book, Inc., (1996), p.467.

RI = ((Velocity A – Velocity B)/Velocity A) in measurements

where:

A = velocity cursor +

B = velocity cursor x

Time Averaged Mean (TAM) in cm/s

TAM = mean (mean Trace)

Time Averaged Peak (TAP) in cm/s

TAP = mean (peak Trace)

Volume (Vol)

Beyer, W.H. *Standard Mathematical Tables*, 28th ed., CRC Press, Boca Raton, FL, (1987), p.131.

Volume Bladder

Dicuccio, M., et al. "Measurements of urinary bladder volume: comparison of five ultrasound calculation methods in volunteers." *Arch. Ital. Urol Androl*,(2005) Mar;77(1): p.60-2.

Volume Flow (VF) in ml/m

Allan, Paul L. et al. *Clinical Doppler Ultrasound*, 4th ed., Harcourt Publishers Limited. (2000), p.36-38.

One of the following, depending on the Live Trace setting:

VF = CSA * TAM * 60

VF = CSA * TAP * 60

VF = CSA * TAV * 60 (When manual trace is used)

Volume Follicle

Raine-Fenning, N. et al. *Ultrasound in Obstetrics & Gynecology* (2008), Volume 31, Issue 6, John Wiley & Sons, Ltd., p.691–696.

Volume Ovarian

Balen, A.H., Laven, J.S., Tan, S.L, Dewailly, D. "Ultrasound assessment of the polycystic ovary: international consensus definitions." *Human Reproduction Update*, (2003), Vol.9, No.6, p. 505-514.

Volume Uterine

Wiener, J. J. and Newcombe, R. G. "Measurements of uterine volume: a comparison between measurements by ultrasonography and by water displacement." *J. Clin. Ultrasound*. (1992) 20 (7), p.457–460.

CHAPTER 7

Troubleshooting and maintenance

This section contains information to help correct problems with system operation, to enter a software license, and to take proper care of the system, transducer, and accessories.

Troubleshooting

If you encounter difficulty with the system, use the following list to help troubleshoot the problem. In the case of a warning dialogue, perform the suggested action. If the problem persists, contact FUJIFILM SonoSite Technical Support (see “[Getting help](#)” on page 1-3).

- ▶ **System does not turn on.** Check all power connections.
 - ▶ Unplug and plug back in the power supply AC and DC power cables (desktop system).
 - ▶ Check that all three battery switches are in the ON position, which is indicated by the **ⓘ** symbol, and ensure that the batteries are charged (stand system).
 - ▶ Plug the system into AC power to reactivate battery operation if the battery switches have been in the OFF position, which is indicated by the **•ⓘ** symbol (stand system).
- ▶ **System image quality is poor.** Adjust the clinical monitor to improve viewing angle.
 - ▶ Adjust the brightness.
 - ▶ Adjust the gain.
- ▶ **No CPD image.** Adjust the gain. CPD has a hide control. Ensure that this control is not activated.
- ▶ **No Color image.** Adjust the gain or the PRF scale. Color has a hide control. Ensure that this control is not activated.
- ▶ **No measurement selections.** Ensure the desired exam type has been selected and that the image is frozen. Tap **Calcs** in the Controls bar, or from **More Controls**.
- ▶ **No sound.** If you do not hear system sounds when you use the system on the desktop, make sure that you have configured audio settings correctly (see “[Audio settings](#)” on page 3-6). If you still do not hear system sounds, cycle power: Turn the isolation transformer power switch to the OFF position and then turn it to the ON position.

- ▶ **Printing does not work.** If you are printing to a DICOM printer, check with your system administrator to make sure that DICOM settings are accurate and that your system is connected to the network.

If you are printing to a local printer, do any of the following:

- ▶ Check the printer connections. The system will automatically detect the printer.

Note

If you are using the AC printer, the system must be connected to AC mains.

- ▶ Ensure that the local printer is turned on and set up properly. See the printer manufacturer's instructions, if necessary.

Only saved images and video clips and the current patient's worksheets can be printed.

- ▶ **DVR does not record.** Make sure that the USB memory stick has enough available space.
- ▶ **System does not recognize the transducer.** Disconnect and reconnect the transducer.
- ▶ **Maintenance icon () appears on screen.** Restart the system. If the issue recurs, system maintenance may be required. Note the number that appears in parentheses on the C: line and contact FUJIFILM SonoSite or your FUJIFILM SonoSite representative.
- ▶ **System prompts you to ensure the USB device is valid.** Use the USB memory stick included with the system.

Make sure that the USB memory stick is not software-encrypted and is not defective.

- ▶ **System prompts you to ensure the USB device contains valid data.** Make sure that the data are present on the USB memory stick.

Re-export the original data onto the USB memory stick. Contact your system administrator.

- ▶ **USB device does not appear in the list.** Check that the USB device has been properly inserted into an available USB slot. Use the USB memory stick that came with the system.
- ▶ **System displays the alert "...internal storage device is full."** Free internal storage space by ending the current exam, archiving or exporting patient exams, and then deleting them from the system.
- ▶ **Cannot access Patient Form. Cannot access Patient List.** Ensure that you are logged in as a user, not as a guest.
- ▶ **System does not export or transfer video clips (DICOM).** In the **Archiver** settings of DICOM Config, make sure that **Exclude Video Clips** is not checked.

Software licensing

FUJIFILM SonoSite software is controlled by a license key. After you install new software, the system prompts you for a license key. You must obtain one key for each system and transducer package that uses the software.

The software will operate for a short time (the grace period) without a license key. During the grace period, all system functions are available. After the grace period, the system is not usable until you enter a valid license key. Grace period time is not used while the system is off or asleep. Grace period time remaining appears on the license update screen.

Caution

After the grace period expires, all system functions except licensing are unavailable until you enter a valid license key.

To obtain a license key

- 1 Turn on the system.
- 2 Navigate to System Information to gather version information:
 - a Tap **MORE** and then tap **System Settings**.
 - b Tap **System Information** in the list on the left and scroll to display System Licensing and Scanhead Licensing.
- 3 Contact FUJIFILM SonoSite Technical Support (see **“Getting help”** on page 1-3). You will be asked for the following information from System Information:
 - a Your name
 - b System serial number.

You will find the serial number on the back of the stand column. Raise the stand to maximum height to reveal the label (see “[Adjusting the height and angle](#)” on page 2-17).

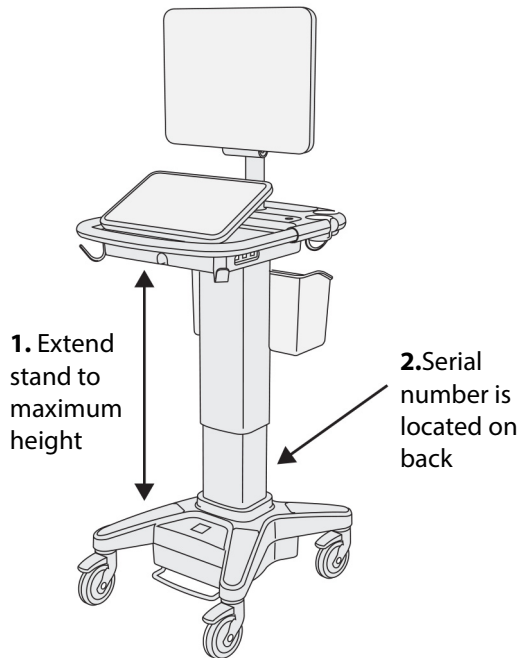

c PCBA serial number

d Software version and transducer package version

4 After you obtain a license key, you must enter it into the system. You can enter it either at startup or in System Setup.

To enter the license key at startup

1 Turn on the system.

The license update screen appears.

2 Enter the license key in the **Enter license number** box.

3 Tap **Enter**.

Note

Do not tap **Done**. This will close the form without entering the key.

4 If the license update screen reappears, verify that you entered the license key correctly. If the license update screen still appears, contact FUJIFILM SonoSite Technical Support (see “[Getting help](#)” on page 1-3).

To enter the license key in System Settings

- 1 Tap **MORE**, and then tap **System Settings**.
- 2 Tap **System Information** in the list on the left.
- 3 Enter the license key in the **Enter license key** boxes in the **System Licensing** or **Scanhead Licensing** section.
- 4 Tap **ENTER**.

Maintenance

WARNINGS

- ▶ No modification of this equipment, except as described in this manual or the SonoSite X-Porte Service Manual, is allowed.
- ▶ Do not service or perform maintenance procedures on the system while it is in use with a patient.

No periodic or preventive maintenance is required for the system, transducer, or accessories other than cleaning and disinfecting the transducer after every use. For information on cleaning and disinfecting your ultrasound system, see [Chapter 8, "Cleaning and disinfecting."](#) No internal components require periodic testing or calibration.

In addition to cleaning and disinfecting the transducer, FUJIFILM SonoSite recommends that you plug the system in when not in use to fully charge the batteries. When charging, all three battery switches must be in the ON position.

Performing maintenance procedures not described in this document or the service manual may void the product warranty. Contact FUJIFILM SonoSite Technical Support for any maintenance questions (see ["Getting help"](#) on page 1-3).

System backups

To safeguard against loss of data, FUJIFILM SonoSite recommends that you routinely back up:

- ▶ Patient data
- ▶ System configuration settings

Patient data

Digital Imaging and Communications in Medicine (DICOM) provides a way to archive patient data by connecting your ultrasound system over a local area network (LAN) with various archivers for storage after every patient exam. FUJIFILM SonoSite recommends that you configure and use DICOM transfer to prevent patient data loss in the event of a system fault. For more information, see “**DICOM**” on page 3-14.

If you do not use DICOM networking, then FUJIFILM SonoSite recommends that you configure your system for automatic export of patient data to a USB memory stick after every exam. For more information, see “**USB settings**” on page 3-39.

System configuration settings

In addition to patient data, FUJIFILM SonoSite recommends that you back up ultrasound system configuration settings, called presets, after you have fully configured the system and any time you modify these settings. These backups preserve your customized settings in case of a fault in the system. For more information, see “**Presets settings**” on page 3-31.

Servicing

Your ultrasound engine may be repaired or replaced at the manufacturer’s discretion. If servicing is necessary, then you must remove the ultrasound engine. Before the engine is removed and shipped to a repair facility, you must take precautions to protect patient data and to preserve your customized settings.

Cautions

- ▶ To protect patient privacy, all patient procedure information must be exported to a USB memory stick or archived to a secure repository via DICOM transfer and then deleted from the Patient List.
- ▶ To preserve your configuration settings, export Presets and DICOM settings to a USB memory stick and store the stick in a secure location.

To prepare your system for service

- 1 End any in-progress procedures.
- 2 Export all patient procedure information to a USB stick or archive it to a DICOM device. For complete instructions, see “**Archiving and exporting**” on page 4-44.
- 3 To delete all patient data, tap **Patient** and then **Patient List**.
- 4 Tap **Select All** and then tap **Delete**.
- 5 If using DICOM, delete worklist data by tapping **Patient** and then **Worklist**. Tap **Clear**.
- 6 Export the following items to a USB memory stick:
 - ▶ System preferences (that is, presets)

- ▶ System log file
- ▶ Assert log file
- ▶ Note: Exporting the Assert log file requires administrator access.
- ▶ User log file
- ▶ DICOM log file (DICOM users only)
- ▶ DICOM settings (DICOM users only)

For information on importing and exporting, see [“Importing and exporting”](#) on page 3-36 and [“Importing and exporting connectivity settings”](#) on page 3-13.

To remove a transducer

- 1 Pull the transducer latch down away from the connector housing, and rotate it clockwise.
- 2 Pull the transducer connector away from the system.

To remove the engine from the stand

Cautions

- ▶ Turn off the system before removing the ultrasound engine from the stand. Removing the ultrasound system from the stand while the system is powered on may damage the dock.
- ▶ Disconnect any devices attached to the ultrasound engine (such as the Triple Transducer Connect, USB memory sticks, transducers, power cables, or ECG cables) before removing it from the stand. Failure to disconnect attached devices may result in damage to the system or accessories.

- 1 Locate the two gray latch levers under the left and right sides of the stand head.

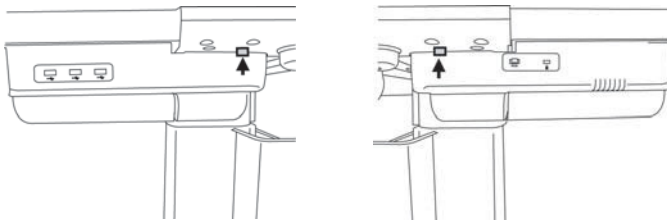

- 2 Simultaneously pull each latch outward, away from the engine and towards the outer edges of the stand. The engine ejects from the stand.

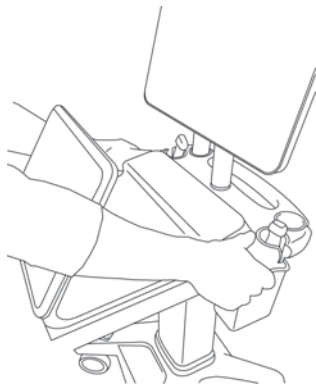

- 3 Lift the engine from the back edge and lift forward and up away from the top of the stand.

CHAPTER 8

Cleaning and disinfecting

This section updates the instructions for cleaning and disinfecting the ultrasound system, transducers, and accessories.

Use the FUJIFILM SonoSite recommendations when cleaning or disinfecting your ultrasound system, transducer, and accessories. Use the cleaning recommendations in the peripheral manufacturer's instructions when cleaning or disinfecting your peripherals.

The system and transducers must be cleaned and disinfected after each exam. It is important to follow these cleaning and disinfecting instructions without skipping any steps.

See www.sonosite.com/products/transducers, for transducer images.

Before getting started

- ▶ Follow the disinfectant manufacturer's recommendations regarding appropriate personal protective equipment (PPE), such as protective eyewear and gloves.
- ▶ Inspect the system and transducer to determine that it is free of any unacceptable deterioration, such as corrosion, discoloration, pitting, or cracked seals. If damage is evident, discontinue use, and contact FUJIFILM SonoSite or your local representative.
- ▶ Confirm that cleaning and disinfecting materials are appropriate for your facility's use. FUJIFILM SonoSite tests cleaners and disinfectants for use with FUJIFILM SonoSite systems and transducers.
- ▶ Disinfectants and cleaning methods listed in this chapter are recommended by FUJIFILM SonoSite for efficacy and material compatibility with the products.
- ▶ Ensure that the disinfectant type and the solution strength and duration are appropriate for the equipment and application.
- ▶ Follow manufacturer recommendations and local regulations, when preparing, using and disposing of chemicals.

WARNINGS

- ▶ Ensure that cleaning and disinfecting solutions and wipes are not expired
- ▶ Some cleaners and disinfectants can cause an allergic reaction to some individuals.

Cautions

- ▶ Do not allow cleaning solution or disinfectant into the system connectors, or transducer connector.
- ▶ Do not use strong solvents such as thinner or benzene, or abrasive cleansers, since these will damage the exterior surfaces. Use only FUJIFILM SonoSite approved cleaners or disinfectants.

Determining the required cleaning and disinfecting level

WARNING

The cleaning instructions contained in this chapter are based on requirements mandated by the U.S. Food and Drug Administration (FDA). Failure to follow these instructions may result in cross contamination and patient infection.

The level of cleaning and disinfecting required for the system is dictated by the type of tissue it contacts during use. Use [Table 8-1](#) to determine the level of cleaning and disinfecting required.

Table 8-1: Choosing a cleaning and disinfecting method

Did any part of the system or transducer come in contact with broken skin, blood, mucosal membranes, or bodily fluids?	
YES Came in contact with broken skin, blood, mucosal membranes, or bodily fluids.	➔ Option A Go to “Clean and disinfect system and transducer to a high-level (semi-critical uses)” on page 8-3
OR	
NO Did not come in contact with broken skin, blood, mucosal membranes, or bodily fluids.	➔ Option B Go to “Clean and disinfect system and transducer to a low-level (non-critical uses)” on page 8-8

Spaulding classifications

Spaulding classifications (non-critical, semi-critical) determine the approach for cleaning and disinfecting medical equipment based on the device, the way it has been used, and the risk of infection. The system and transducers are designed for use within the Spaulding classifications of non-critical and semi-critical uses.

Option **A** Clean and disinfect system and transducer to a high-level (semi-critical uses)

Use this procedure to clean and high-level disinfect the ultrasound system and transducer **whenever it has come into contact with blood, broken skin, mucosal membranes, or bodily fluids**.

Follow the manufacturer's instructions when using cleaners and disinfectants. The cleaners and disinfectants listed in the procedure are both chemically compatible and have been tested for efficacy with the system and transducers. Confirm that the cleaners and disinfectants are appropriate for your facility's use.

WARNINGS

- ▶ To avoid electrical shock, before cleaning, turn off the system and disconnect it from the power supply.
- ▶ Wear the appropriate personal protective equipment (PPE) recommended by the chemical manufacturer, such as protective eyewear and gloves.

Cautions

- ▶ Do not skip any steps or abbreviate the cleaning and disinfecting process in any way.
- ▶ Do not spray cleaners or disinfectants directly on the system surfaces or on system and transducer connectors. Doing so may cause solution to leak into the system, damaging it and voiding the warranty.
- ▶ Do not attempt to disinfect a transducer or transducer cable using a method that is not included here or a chemical not listed in this guide or on www.sonosite.com/support/cleaners-disinfectants. This can damage the transducer and void the warranty.
- ▶ Use only FUJIFILM SonoSite approved cleaners and disinfectants. Using an unapproved disinfecting solution or incorrect solution strength can damage the system and transducer and void the warranty. Follow the disinfectant manufacturer's recommendations for solutions strengths.

Notes

- ▶ You must clean and disinfect both the ultrasound system and the transducer after each use, but only the transducer can be disinfected to a high-level.
- ▶ To clean the TEE_{Exp} transducer, refer to the *TEE_{Exp} Transducer User Guide*.

To clean and disinfect the system and transducer

- 1 Turn off** the system by pressing the **Power button**.
- 2 Unplug** the power cord from the outlet.
- 3 Remove** the disposable transducer sheath, if applicable.

- 4 Disconnect** the transducer from the system. Temporarily place it where it will not cross-contaminate clean equipment or surfaces while you clean the ultrasound system.
- 5 Clean** the exterior surfaces of the **ULTRASOUND SYSTEM** to remove any debris or bodily fluids. Use the following procedure:

- a** Use either a pre-moistened wipe or a soft cloth dampened with cleaner or disinfectant. Choose a cleaner from the list of approved cleaners.

Approved cleaners/disinfectants for the ultrasound system:

Cleaner/disinfectant	Minimum wet contact time ^a
SaniCloth AF3 ^b	3 minutes
SaniCloth Plus	3 minutes
PI-Spray II	10 minutes

^a Refer to the manufacturer’s instructions for concentration, temperature, and duration.

^b Qualified for use as an intermediate-level disinfectant for mycobacteria.

Refer to the cleaners and disinfection tool available at www.sonosite.com/support/cleaners-disinfectants for a more complete list of approved cleaners and disinfectants.

- b** Remove all gel, debris, and bodily fluids from the system.
 - c** With a new wipe, clean the system, including the display, by wiping from clean areas to the soiled areas. This method helps to avoid cross-contamination.
 - d** Observe the minimum wet contact time and refer to manufacturer’s instructions. Monitor the system for wet appearance. Re-apply with a new wipe if no longer wet.
 - e** Allow the ultrasound system to air dry in a clean, well-ventilated space.
- 6 Clean** the ultrasound system **STAND** to remove any debris or bodily fluids.
- 7 Clean** the **TRANSDUCER CABLE AND BODY** to remove any debris or bodily fluids. Use the following procedure:

- a Use either a premoistened wipe or a soft cloth dampened with cleaner or disinfectant. Choose a cleaner from the list of approved cleaners.

Approved cleaners/disinfectants for the transducer:

Product	Compatible transducers	Minimum wet contact time ^a
SaniCloth AF3 ^b	C11xp, C35xp, C60xp, HFL38xp, HFL50xp, HSL25xp, ICTxp, L25xp, L38xp, P10xp, P21xp, rP19xp	3 minutes
SaniCloth Plus	C60xp, HFL38xp, HFL50xp, ICTxp	3 minutes
PI-Spray II	C11xp, C60xp, D2xp, HFL38xp, HFL50xp, HSL25xp, ICTxp, L25xp, L38xp, P10xp, P21xp, rP19xp	10 minutes

^a Refer to the manufacturer’s instructions for concentration, temperature, and duration.

^b Qualified for use as an intermediate-level disinfectant for mycobacteria.

Refer to the cleaners and disinfection tool available at www.sonosite.com/support/cleaners-disinfectants for a more complete list of approved cleaners and disinfectants.

- b Remove all gel, debris, and bodily fluids from the transducer.
- c With a new wipe, clean the cable and transducer, starting from the cable, wiping toward the scanhead. This method helps to avoid cross-contamination.

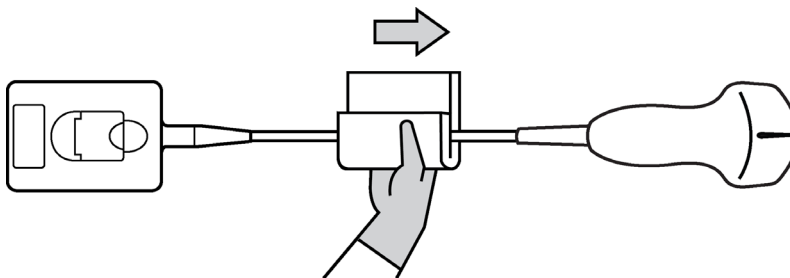

Caution | Do not allow moisture near the electronic components of the connector.

- d Observe the minimum wet contact time and refer to manufacturer’s instructions. Monitor the transducer for wet appearance. Re-apply with a new wipe if no longer wet.
- 8 Verify** that all gel, debris, and bodily fluids have been removed from the system and transducer. If necessary, repeat steps 5, 6, and 7 with a new wipe.

WARNING | Failure to remove all gel, debris, and bodily fluid could leave contaminants on the transducer.

9 Prepare the disinfectant for use.

- a Choose a high-level disinfectant from the list of approved disinfectants.

High-level disinfectants compatible with SonoSite X-Porte transducers:

Disinfectant ^a	Compatible transducers	Temperature	Disinfectant soak duration
Cidex	C11xp, C35xp, C60xp, HFL38xp, HFL50xp, HSL25xp, ICTxp, L25xp, L38xp, P10xp, P21xp, rP19xp	25°C, 77°F	45 minutes
Cidex OPA	C11xp, C60xp, HFL38xp, HFL50xp, HSL25xp, ICTxp, L25xp, L38xp, P10xp, P21xp, P19xp	20°C, 68°F	12 minutes
Revital-Ox RESERT	C35xp	20°C, 68°F	8 minutes

^aRefer to the manufacturer's instructions for concentration, temperature, and duration.

Refer to the cleaners and disinfection tool available at www.sonosite.com/support/cleaners-disinfectants for a more complete list of approved cleaners and disinfectants..

- b Check the expiration date on the bottle to ensure the disinfectant has not expired.
- c Mix or check that the disinfection chemicals have the concentration recommended by the manufacturer (for example, a chemical strip test).
- d Check that the temperature of the disinfectant is within the manufacturer's recommended limits.

10 Perform a high-level disinfection of the transducer. Use the following procedure:

- a Immerse the transducer in a high-level disinfectant solution.

WARNING

High-level disinfectants can cause harm to the patient if not completely removed from the transducer. Follow the manufacturer's rinse instructions to remove chemical residue.

Cautions

- ▶ Do not soak the transducer longer than recommended by the chemical manufacturer.
- ▶ Do not immerse the transducer connector in any disinfectant solution.
- ▶ Use only FUJIFILM SonoSite approved cleaners and disinfectants. Using an unapproved disinfecting solution or incorrect solution strength can damage or discolor the transducer and void the warranty.

- b** Ensure that the connector and most of the cable remain out of the fluid. You may submerge 2 inches (5 cm) of the cable proximal to the transducer scanhead.

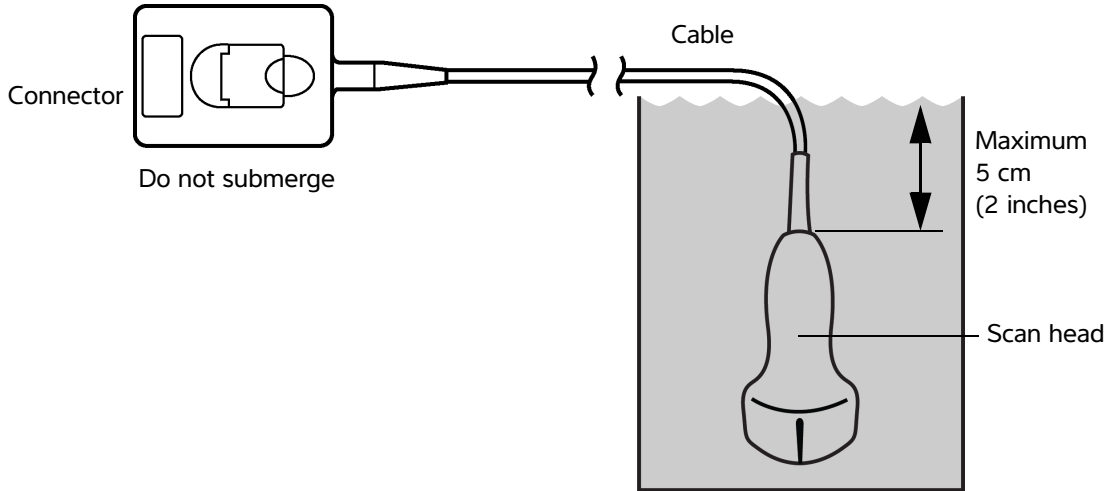

Figure 8-1 Transducer component names

11 Rinse the transducer **3 separate times** using the following procedure:

- a** Rinse the transducer in clean, running water according to the disinfectant manufacturer's instructions (at least 1 minute).
- b** Ensure that the connector and at least 12-18 inches (31-46 cm) of the cable from the connector remain out of the fluid.
- c** Replace the rinse water before beginning the next rinse.

12 Dry the transducer with a sterile lint-free cloth.

13 Dispose of the disinfectant according to the manufacturer's guidelines.

14 Examine the transducer and cable for damage, such as cracks or splitting where fluid can enter.

If damage is evident, discontinue use of the transducer, and contact FUJIFILM SonoSite or your local representative.

Option **B** Clean and disinfect system and transducer to a low-level (non-critical uses)

Use the following procedure to clean and disinfect the ultrasound system and transducer **if it has not come into contact with blood, broken skin, mucosal membranes, or bodily fluids.**

WARNING

If the system or transducer has come into contact with any of the following, use the high-level cleaning and disinfection procedure. See “**Clean and disinfect system and transducer to a high-level (semi-critical uses)**” on page 8-3.

- ▶ Blood
- ▶ Broken skin
- ▶ Mucosal membranes
- ▶ Bodily fluids

Follow the manufacturer's instructions when using cleaners and disinfectants. The cleaners and disinfectants listed in the procedure are both chemically compatible and have been tested for efficacy with the system and transducers. Confirm that the cleaners and disinfectants are appropriate for your facility's use.

WARNINGS

- ▶ To avoid electrical shock, before cleaning, turn off the system and disconnect it from the power supply.
- ▶ Wear the appropriate personal protective equipment (PPE) recommended by the chemical manufacturer, such as protective eyewear and gloves.

Cautions

- ▶ Do not spray cleaners or disinfectants directly on the system surfaces or on system and transducer connectors. Doing so may cause solution to leak into the system, damaging it and voiding the warranty.
- ▶ Use only FUJIFILM SonoSite-approved cleaners and disinfectants. Using an unapproved disinfecting solution or incorrect solution strength can damage the System and transducer and void the warranty. Follow the disinfectant manufacturer's recommendations for solutions strengths.
- ▶ Do not attempt to disinfect a transducer or transducer cable using a method that is not included here or a chemical not listed in this guide or on www.sonosite.com/support/cleaners-disinfectants. Doing so can damage the transducer and void the warranty.

To clean and disinfect the system and transducer

- 1 Turn off** the system by pressing the **Power button**.
- 2 Unplug** the power cord from the outlet.

3 Remove the transducer sheath, if applicable.

4 Disconnect the transducer from the system. Temporarily place it where it will not cross-contaminate clean equipment or surfaces while you clean the ultrasound system.

5 Clean the exterior surfaces of the **ULTRASOUND SYSTEM** to remove any debris or bodily fluids. Use the following procedure:

- a** Use either a pre-moistened wipe or a soft cloth dampened with cleaner and disinfectant. Choose a cleaner from the list of approved cleaners.

Approved cleaners/disinfectants for the ultrasound system:

Cleaner/disinfectant	Minimum wet contact time ^a
SaniCloth AF3 ^b	3 minutes
SaniCloth Plus	3 minutes
PI-Spray II	10 minutes

^a For maximum effectiveness, the component being cleaned must remain wet with disinfectant for a minimum period of time.

^b Qualified for use as an intermediate-level disinfectant for mycobacteria.

Refer to the cleaners and disinfection tool available at www.sonosite.com/support/cleaners-disinfectants for a more complete list of approved cleaners and disinfectants.

- b** Remove all gel, debris, and bodily fluids from the system.

c With a new wipe, clean the system, including the display, by wiping from clean areas to the soiled areas. This method helps to avoid cross-contamination.

d Observe the minimum wet contact time and refer to manufacturer's instructions. Monitor the system for wet appearance. Re-apply with a new wipe if no longer wet.

6 Clean the ultrasound system **STAND** to remove any debris or bodily fluids.

7 Clean the **TRANSDUCER CABLE AND BODY** to remove any debris or bodily fluids. Use the following procedure:

- a Use either a pre-moistened wipe or a soft cloth dampened with cleaner or disinfectant. Choose a cleaner from the list of approved cleaners.

Approved cleaners/disinfectants for the transducer:

Product	Compatible transducers	Minimum wet contact time ^a
SaniCloth AF3 ^b	C11xp, C35xp, C60xp, HFL38xp, HFL50xp, HSL25xp, ICTxp, L25xp, L38xp, P10xp, P21xp, rP19xp	3 minutes
SaniCloth Plus	C60xp, HFL38xp, HFL50xp, ICTxp	3 minutes
PI-Spray II	C11xp, C60xp, D2xp, HFL38xp, HFL50xp, HSL25xp, ICTxp, L25xp, L38xp, P10xp, P21xp, rP19xp	10 minutes

^a For maximum effectiveness, the component being cleaned must remain wet with disinfectant for a minimum period of time.

^b Qualified for use as an intermediate-level disinfectant for mycobacteria.

Refer to the cleaners and disinfection tool available at www.sonosite.com/support/cleaners-disinfectants for a more complete list of approved cleaners and disinfectants.

- b Remove all gel, debris, and bodily fluids from the transducer.
- c With a new wipe, clean the cable and transducer, starting from the cable, wiping toward the scanhead. This method helps to avoid cross-contamination.

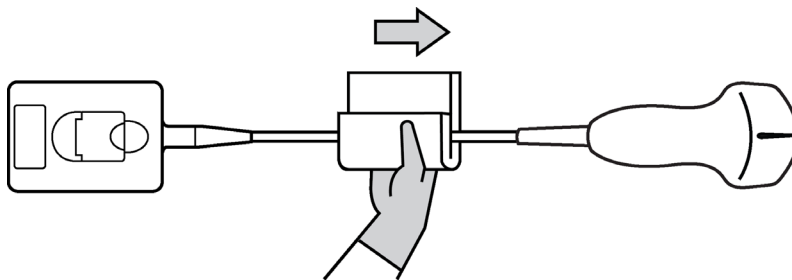

Caution | Do not allow moisture near the electronic components of the connector.

- d Observe the required wet contact time and refer to manufacturer’s instructions. Monitor the transducer for wet appearance. Re-apply with a new wipe if no longer wet.
- 8 Verify** that all gel, debris, and bodily fluids have been removed from the system and transducer. If necessary, repeat steps 5, 6, and 7 with a new wipe.

9 Allow the ultrasound system, including the console and transducer, to air dry in a clean, well-ventilated space.

10 Examine the system, transducer and cable for damage, such as cracks or splitting where fluid can enter.

If damage is evident, do not use the transducer. Instead, contact FUJIFILM SonoSite or your local representative.

Storing the transducer

To store the transducer

1 Make sure the transducer has been cleaned and disinfected as detailed in the previous section.

2 Store the transducer so that it hangs freely and vertically, and observe the following precautions:

- ▶ Store the transducer away from any contaminated transducers.
- ▶ Store the transducer in an environment that is safe and has good airflow. Do not store the transducer in closed containers or where condensation may occur.
- ▶ Avoid direct sunlight and exposure to x-rays. Recommended storage temperature range is between 0° C (32° F) and +45° C (113° F).
- ▶ If using a wall-mounted rack for storage, ensure that:
 - ▶ It is securely mounted.
 - ▶ The storage slots do not mar the transducer or cause damage to the cable.
 - ▶ The rack is sized and positioned to prevent the transducer from inadvertently falling.
 - ▶ Make sure the connector is supported and secure.

Transporting the transducer

When transporting the transducer, you must take precautions to protect the transducer from damage and avoid cross-contamination. Be sure to use a container approved by your organization.

To transport a soiled transducer for cleaning

A soiled transducer is one that has been contaminated and must be cleaned before using it in an exam.

- 1 Place the transducer in a clean, approved container.

WARNING

To prevent cross-contamination or unprotected exposure of personnel to biological material, containers used to transport contaminated transducers should carry an ISO biohazard label similar to the following:



Caution

Ensure the transducer is dry before placing it in a closed container. Condensation from a damp transducer can damage the connector.

- 2 Transport the transducer in the container to the point of processing. Do not open the container until the transducer is ready to be cleaned.

Caution

Do not leave the transducer in a sealed container for long periods of time.

To transport a clean transducer

A clean transducer is one that has completed the cleaning and disinfection process, has been stored properly, and is ready to be used in an examination.

- 1 Place the transducer in a clean, approved container. To identify the transducer as clean, containers used to transport clean transducers should carry a cleanliness verification sticker or certificate.
- 2 Transport the transducer in the container to the point of use. Do not open the container until the transducer is ready to be used.

To ship a transducer

WARNING

Whenever possible, avoid shipping a contaminated transducer. Before shipping, ensure the transducer has been cleaned and disinfected using the steps detailed in this chapter or according to special instructions received from FUJIFILM SonoSite. If you are returning the transducer to FUJIFILM SonoSite, document the disinfection on a "Declaration of Cleanliness," and attach it to the packing list.

- 1 Place the transducer in the shipping container and seal it. Do not allow any part of the transducer to protrude from the container.
- 2 Ship the transducer using the following precautions:
 - ▶ Clearly label the container as fragile.

- ▶ Do not stack items on top of the shipping container.
- ▶ Do not exceed the shipping temperature range: -35° C (-31° F) to +65° C (149° F).
- ▶ Do not open the shipping container until it reaches its final destination.
- ▶ After arrival, the transducer must be cleaned and disinfected before it can be used in an exam.

Accessories

To clean and disinfectant the stand or Triple Transducer Connect, (TTC), see “[Cleaning and disinfecting the stand or Triple Transducer Connect \(TTC\)](#)” on page 8-14.

To clean the footswitch see “[Cleaning the footswitch](#)” on page 8-14.

To clean ECG cables, see “[Cleaning and disinfecting the ECG cable and slave cable](#)” on page 8-15.

To clean the ECG slave cable, refer to the *ECG Slave Cable & Adapter Kit User Guide*.

Use the cleaning and disinfecting recommendations in the peripheral manufacturer’s instructions when cleaning or disinfecting peripherals.

Cleaning and disinfecting accessories

Clean accessories prior to disinfecting. You can disinfect the exterior surface of accessories using a recommended disinfectant. Refer to the cleaners and disinfection tool available at www.sonosite.com/support/cleaners-disinfectants.

WARNING

To avoid electrical shock, always disconnect the power supply before cleaning the PowerPark.

To clean and disinfect accessories

- 1 If necessary, unplug the power supply, and detach any cables.
- 2 Clean the exterior surfaces of the accessory using a soft cloth lightly dampened in a mild soap or detergent cleaning solution to remove any particulate matter or body fluids.

Apply the solution to the cloth rather than the surface.

- 3 Mix the disinfectant solution compatible with the accessory, following disinfectant label instructions for solution strengths and disinfectant contact duration. Refer to the cleaners and disinfection tool available at www.sonosite.com/support/cleaners-disinfectants.

- 4 Wipe surfaces with the disinfectant solution. See “[Cleaning and disinfecting the stand or Triple Transducer Connect \(TTC\)](#)” on page 8-14.
- 5 Air dry or towel dry with a clean cloth.

Cleaning and disinfecting the stand or Triple Transducer Connect (TTC)

To clean and disinfect the stand or TTC

You can clean and disinfect the exterior surface of the stand or TTC using a recommended cleaner or disinfectant.

- 1 Do one of the following:
 - ▶ If cleaning the stand, unplug the power supply, detach any cables from the system, and remove the system.
 - ▶ If cleaning the TTC, remove it from the system platform.
- 2 Clean the surfaces using a soft cloth lightly dampened in a mild soap or detergent cleaning solution.

Apply the solution to the cloth rather than the surface.
- 3 Wipe the surfaces with the disinfecting solution. Follow the manufacturer’s instructions for the disinfecting solution, including exposure time and temperature for effective disinfection.
- 4 Air dry or towel dry with a clean cloth.

Cleaning the footswitch

Caution

To avoid damaging the footswitch, do not sterilize. It is not intended for use in a sterile environment.

To clean the footswitch

Use the disinfecting recommendations in the peripheral manufacturer’s instructions when disinfecting the footswitch.

- 1 Dampen a non-abrasive cloth with a recommended cleaner or disinfectant.
- 2 Wring out cloth until slightly wet and then gently rub soiled area until clean.

Cleaning and disinfecting the ECG cable and slave cable

Caution | To avoid damaging the ECG cable, do not sterilize.

To clean and disinfect the ECG cables (wipe method)

- 1 Remove the cable from the system.
- 2 Examine the ECG cable for damage such as cracks or splitting.
- 3 Clean the surface using a soft cloth lightly dampened in a mild soap, cleaning solution, or pre-moistened wipe. Apply the solution to the cloth rather than the surface.
- 4 Wipe the surfaces with a FUJIFILM SonoSite Approved cleaner or disinfectant.
- 5 Air dry or dry with a clean cloth.

For more information on the ECG slave cable, refer to the *ECG Slave Cable User Guide*.

CHAPTER 9

Safety

This section contains general safety information that applies to the ultrasound system, transducers, accessories, and peripherals.

Ergonomic safety

These scanning guidelines are intended to assist you in the comfortable and effective use of your ultrasound system.

WARNINGS

- ▶ To prevent musculoskeletal disorders, follow the guidelines in this section.
- ▶ Use of an ultrasound system may be linked to musculoskeletal disorders (MSDs).^{1,2,3}
- ▶ Use of an ultrasound system is defined as the physical interaction between the operator, the ultrasound system, and the transducer.
- ▶ When using an ultrasound system, as with many similar physical activities, you may experience occasional discomfort in your hands, fingers, arms, shoulders, eyes, back, or other parts of your body. However, if you experience symptoms such as constant or recurring discomfort, pain, throbbing, aching, tingling, numbness, burning sensation, or stiffness, do not ignore these warning signs. Promptly see a qualified health professional. Symptoms such as these can be linked with MSDs. MSDs can be painful and may result in potentially disabling injuries to the nerves, muscles, tendons, or other parts of the body. Examples of MSDs include carpal tunnel syndrome and tendonitis.

1. Magnavita, N., L. Bevilacqua, P. Mirk, A. Fileni, and N. Castellino. "Work-related Musculoskeletal Complaints in Sonologists." *Occupational Environmental Medicine*. 41:11 (1999), p. 981-988.
2. Craig, M. "Sonography: An Occupational Hazard?" *Journal of Diagnostic Medical Sonography*. 3 (1985), p.121-125.

3. Smith, C.S., G.W. Wolf, G. Y. Xie, and M. D. Smith. "Musculoskeletal Pain in Cardiac Ultrasonographers: Results of a Random Survey." *Journal of American Society of Echocardiography*. (May 1997), p. 357-362.

WARNING

While researchers are not able to definitively answer many questions about MSDs, there is a general agreement that certain factors are associated with their occurrence including preexisting medical and physical conditions, overall health, equipment and body position while doing work, frequency of work, duration of work, and other physical activities that may facilitate the onset of MSDs¹. This section provides guidelines that may help you work more comfortably and may reduce your risk of MSDs^{2,3}.

1. Wihlidal, L.M. and S. Kumar. "An Injury Profile of Practicing Diagnostic Medical Sonographers in Alberta." *International Journal of Industrial Ergonomics*. 19 (1997), p.205-216.
2. Habes, D.J. and S. Baron. "Health Hazard Report 99-0093-2749." *University of Medicine and Dentistry of New Jersey*. (1999).
3. Vanderpool, H.E., E.A. Friis, B.S. Smith, and K.L. Harms. "Prevalence of Carpal Tunnel Syndrome and Other Work-related Musculoskeletal Problems in Cardiac Sonographers." *Journal of Medicine*. 35:6 (1993), p. 605-610.

Position the system

Minimize eye and neck strain

- ▶ If possible, position the system within reach.
- ▶ Adjust the angle of the clinical monitor or touch panel to minimize glare.
- ▶ Adjust the height so that the clinical monitor is at or slightly below eye level.

Position yourself

Support your back during an exam

- ▶ Use a chair that supports your lower back, that adjusts to your work surface height, that promotes a natural body posture, and that allows quick height adjustments.
- ▶ Always sit or stand upright. Avoid bending or stooping.

Minimize reaching and twisting

- ▶ Use a bed that is height adjustable.
- ▶ Position the patient as close to you as possible.
- ▶ Face forward. Avoid twisting your head or body.
- ▶ Move your entire body front to back, and position your scanning arm next to or slightly in front of you.
- ▶ Stand for difficult exams to minimize reaching.
- ▶ Position the monitor directly in front of you.

Promote comfortable shoulder and arm postures

- ▶ Keep your elbow close to your side.
- ▶ Relax your shoulders in a level position.
- ▶ Support your arm using a support cushion or pillow, or rest it on the bed.

Promote comfortable hand, wrist, and finger postures

- ▶ Hold the transducer lightly in your fingers.
- ▶ Minimize the pressure applied on the patient.
- ▶ Keep your wrist in a straight position.

Take breaks, exercise, and vary activities

- ▶ Minimizing scanning time and taking breaks can effectively allow your body to recover from physical activity and help you avoid MSDs. Some ultrasound tasks may require longer or more frequent breaks. However, simply changing tasks can help some muscle groups relax while others remain or become active.
- ▶ Work efficiently by using the software and hardware features correctly.
- ▶ Keep moving. Avoid sustaining the same posture by varying your head, neck, body, arm, and leg positions.
- ▶ Do targeted exercises. Targeted exercises can strengthen muscle groups, which may help you avoid MSDs. Contact a qualified health professional to determine stretches and exercises that are right for you.

Electrical safety

This system meets EN60601-1, Class I/internally-powered equipment requirements and Type BF (transducers) and Type CF (ECG leads) isolated patient-applied parts safety requirements.

The system complies with the safety and EMC standards listed in the Standards section of this document. Refer to “**Standards**” on page 9-35.

For maximum safety observe the following warnings and cautions.

WARNINGS

- ▶ To avoid the risk of injury, do not operate the system in the presence of flammable gases or anesthetics. Explosion can result.
- ▶ To avoid the risk of electrical shock or injury, do not open the system enclosures. All internal adjustments and replacements must be made by a qualified technician.

WARNINGS

- ▶ To avoid the risk of electrical shock:
 - ▶ Use only properly grounded equipment. Shock hazards exist if the power supply is not properly grounded. Grounding reliability can only be achieved when equipment is connected to a receptacle marked “Hospital Only”, “Hospital Grade”, or the equivalent. Do not remove or defeat the grounding wire.
 - ▶ Connect this equipment to a supply mains with protective earth.
 - ▶ Do not let any part of the system (including the bar code scanner, power supply, or power supply connector), except for the transducer or ECG leads, touch the patient.
 - ▶ Do not touch the power supply and the patient at the same time.
 - ▶ Do not touch any of the following:
 - ▶ The signal input/output connectors on the back of the ultrasound system.
 - ▶ The system transducer connector when the transducer or Triple Transducer Connect (TTC) is disconnected.
 - ▶ Any unused TTC transducer connector when the TTC is connected.
 - ▶ Do not connect the system’s power supply to an MPSO (power strip) or extension cord.
 - ▶ Before using the transducer, inspect the transducer face, housing, and cable. Do not use the transducer if the transducer or cable is damaged.
 - ▶ Turn the engine off when cleaning.
 - ▶ Do not use any transducer that has been immersed beyond the specified cleaning or disinfection level. See “**Troubleshooting and maintenance**” on page 7-1.
 - ▶ Use only accessories and peripherals recommended by FUJIFILM SonoSite, including the power supply. Connection of accessories and peripherals not recommended by FUJIFILM SonoSite could result in electrical shock. Contact FUJIFILM SonoSite or your local representative for a list of accessories and peripherals available from or recommended by FUJIFILM SonoSite.
- ▶ To avoid the risk of electrical shock and fire hazard:
 - ▶ Inspect the AC power cords, cables, and plugs on a regular basis. Ensure that they are not damaged.
 - ▶ The power cord set that connects the power supply of the ultrasound system or to mains power must only be used with the power supply, and cannot be used to connect other devices to mains power.
- ▶ To prevent injury to the operator/bystander, the transducer must be removed from patient contact before the application of a high-voltage defibrillation pulse.

WARNINGS

- ▶ Because the only method of completely removing AC power from the stand is to disconnect the AC input power cord from the stand base, ensure that you place the stand in a location in which you can easily remove the AC input power cord if necessary.
- ▶ Failures in the electrical safety design of connected devices may result in a voltage on the ultrasound system. To minimize the risk of electrical shock to the patient and/or operator:
 - ▶ Use medical-grade devices.
 - ▶ After connections are made, test the electrical safety utilizing biomedical department electrical safety procedures.
 - ▶ For added protection, use an isolation transformer between the connecting device and AC power.

Cautions

- ▶ Do not use the system if an error message appears on the image display: note the error code; call FUJIFILM SonoSite or your local representative; turn off the system by pressing and holding the power key until the system powers down.
- ▶ To avoid increasing the system and transducer connector temperature, do not block the airflow to the ventilation holes on the front and back of the system.

Electrical safety classification

Class I equipment	The ultrasound system is classified as Class I equipment when powered from the external power supply or mounted on the stand because the external power supply is a Class 1 protectively earthed power supply.
Internally powered equipment	Ultrasound system not connected to the AC supply
Type BF applied parts	Ultrasound transducers
Type CF applied parts	ECG module/ECG leads
IPX7	Ultrasound transducers
IPX8	Footswitch
Non AP/APG	Ultrasound system power supply, docking system, and peripherals. Equipment is not suitable for use in the presence of flammable anaesthetics.

Isolating the SonoSite X-Porte ultrasound system from power

The SonoSite X-Porte ultrasound system does not become completely isolated from power by pressing the Power button. The only way to completely remove power is to press the Power button, disconnect the AC input power cord from the stand base, and set all three battery switches to the off position.

To isolate the system from power

- 1 Press the Power button.
- 2 Listen for the audio tone.

Caution

Unplugging the AC power cord before you hear the tone may result in loss of data. If you don't hear a tone, then your system may be set up to mute all sounds. To reinstate sounds, see ["Audio settings"](#) on page 3-6.

- 3 Disconnect the AC input power cord from the stand base.
- 4 Depress all three battery switches to the OFF position, indicated by the **•O** symbol.

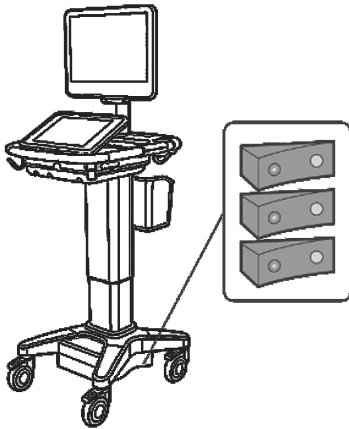

Equipment safety

To protect your ultrasound system, transducer, and accessories, follow these precautions.

WARNING

When transporting your system, to avoid possible injury from the system tipping, always collapse the clinical monitor and push forward on the bar on the platform instead of pushing downward on the bar or pushing the clinical monitor.

Cautions

- ▶ Excessive bending or twisting of cables can cause a failure or intermittent operation.
- ▶ Improper cleaning or disinfecting of any part of the system can cause permanent damage. For cleaning and disinfecting instructions, see [Chapter 8, “Cleaning and disinfecting.”](#)
- ▶ Do not submerge the transducer connector in solution. The cable is not liquid-tight beyond the transducer connector/cable interface.
- ▶ Do not use solvents such as thinner or benzene, or abrasive cleaners on any part of the system.
- ▶ Do not spill liquid on the system.
- ▶ Position the system to allow access to the mains power-cord connector.
- ▶ At high elevations (greater than 1948 meters / 6391 feet above sea level), always operate the ultrasound engine in the stand.

Clinical Safety

WARNINGS

- ▶ To avoid injury, inspect all fasteners and connections.
- ▶ FUJIFILM SonoSite does not recommend the use of high-frequency electromedical devices in proximity to its systems. FUJIFILM SonoSite equipment has not been validated for use with high-frequency electrosurgical devices or procedures. Use of high-frequency electrosurgical devices in proximity to its systems may lead to abnormal system behavior or shutdown of the system. To avoid the risk of a burn hazard, do not use the transducer with high frequency surgical equipment. Such a hazard may occur in the event of a defect in the high frequency surgical neutral electrode connection.
- ▶ The maximum temperature of the transducer scan head may be greater than 41 °C (105.8 °F), but is less than 43 °C (109.4 °F) when in contact with the patient. Special precautions should be considered when using the transducer on children or on other patients who are sensitive to higher temperatures.
- ▶ Do not use the system if it exhibits erratic or inconsistent behavior. Discontinuities in the scanning sequence are indicative of a hardware failure that must be corrected before use.
- ▶ Some transducer sheaths contain natural rubber latex and talc, which can cause allergic reactions in some individuals. FUJIFILM SonoSite recommends identifying your latex- and talc-sensitive patients and being prepared to treat allergic reactions promptly.
- ▶ Perform ultrasound procedures prudently. Use the ALARA (as low as reasonably achievable) principle and follow the prudent use information concerning MI and TI.
- ▶ FUJIFILM SonoSite does not currently recommend a specific brand of acoustic standoff. If an acoustic standoff is used, it must have a minimum attenuation of .3dB/cm/MHz.
- ▶ Use market-cleared, sterile transducer sheaths and sterile coupling gel for transrectal, transvaginal, or guided-needle procedures. Do not apply the transducer sheath and coupling gel until you are ready to perform the procedure. After use, remove and discard the single-use sheath, and clean and disinfect the transducer using a FUJIFILM SonoSite recommended disinfectant.

WARNINGS

- ▶ To avoid injury or reduce the risk of infection to the patient, observe the following:
 - ▶ Follow Universal Precautions when inserting and maintaining a medical device for interventional procedures.
 - ▶ Appropriate training in interventional procedures as dictated by current relevant medical practices as well as in proper operation of the ultrasound system and transducer is required. During vascular access, the potential exists for serious complications including without limitation the following: pneumothorax, arterial puncture, and guidewire misplacement.
- ▶ To avoid device damage or patient injury, do not use the P10xp, P21xp, and rP19xp needle guide brackets on patients with pacemakers or medical electronic implants. The needle guide brackets for the P10xp, P21xp, and rP19xp transducers contain a magnet that is used to ensure the bracket is correctly oriented on the transducer. The magnetic field in direct proximity to the pacemaker or medical electronic implant may have an adverse effect.
- ▶ To avoid applying unsafe voltage levels to the patient while a device is connected to the external VGA or digital video out port, do not touch the ultrasound system and the patient simultaneously. Check the electrical safety of your system with a trained biomedical engineer.

Hazardous materials

WARNING

Products and accessories may contain hazardous materials. When disposing of products and accessories, be environmentally responsible and meet federal and local regulations for disposing hazardous materials.

Electromagnetic compatibility

The ultrasound system has been tested and found to comply with the electromagnetic compatibility (EMC) limits for medical devices to IEC 60601-1-2:2007 and IEC 60601-1-2:2014. The ultrasound system is suitable for use in the professional healthcare facility environment. Active high frequency surgical equipment causes high electromagnetic disturbances, which may interfere with the ultrasound system operation. The ultrasound system should not be operated inside an RF shielded room where magnetic resonance imaging is present because it produces high electromagnetic disturbances. These limits are designed to provide reasonable protection against harmful interference in a typical medical installation.

Note

The emissions characteristics of the SonoSite X-Porte ultrasound system make it suitable for use in industrial areas and hospitals (CISPR 11 class A). If it is used in a residential environment (for which CISPR 11 class B is normally required) the ultrasound system might not offer adequate protection to radio-frequency communication services. It may be necessary to take mitigation measures, such as relocating or re-orienting the equipment.

WARNING

To avoid the risk of increased electromagnetic emissions or decreased immunity, use only accessories and peripherals recommended by FUJIFILM SonoSite. Connection of accessories and peripherals not recommended by FUJIFILM SonoSite could result in malfunctioning of your ultrasound system or other medical electrical devices in the area. Contact FUJIFILM SonoSite or your local representative for a list of accessories and peripherals available from or recommended by FUJIFILM SonoSite. See **“System components and compatible accessories”** on page 9-15.

Cautions

- ▶ Medical electrical equipment requires special precautions regarding EMC and must be installed and operated according to these instructions. It is possible that high levels of radiated or conducted radio-frequency (RF) electromagnetic interference (EMI) from portable and mobile RF communications equipment or other strong or nearby radio-frequency sources, could result in performance disruption of the ultrasound system. Evidence of disruption may include image degradation or distortion, erratic readings, equipment ceasing to operate, or other incorrect functioning. If this occurs, survey the site to determine the source of disruption, and take the following actions to eliminate the source(s).
 - ▶ Turn equipment in the vicinity off and on to isolate disruptive equipment.
 - ▶ Relocate or re-orient interfering equipment.
 - ▶ Increase distance between interfering equipment and your ultrasound system.
 - ▶ Manage use of frequencies close to ultrasound system frequencies.
 - ▶ Remove devices that are highly susceptible to EMI.
 - ▶ Lower power from internal sources within facility control (such as paging systems).
 - ▶ Label devices susceptible to EMI.
 - ▶ Educate clinical staff to recognize potential EMI-related problems.
 - ▶ Eliminate or reduce EMI with technical solutions (such as shielding).
 - ▶ Restrict use of personal communicators (cell phones, computers) in areas with devices susceptible to EMI.
 - ▶ Share relevant EMI information with others, particularly when evaluating new equipment purchases which may generate EMI.
 - ▶ Purchase medical devices that comply with IEC 60601-1-2 EMC Standards.
- ▶ Do not stack other equipment on the ultrasound system or use other equipment in close proximity and adjacent to the ultrasound system. If stacking or using other equipment in close proximity is unavoidable, then you must observe the system to verify normal operation.

Wireless transmission

5 GHz wireless transmission is available by license in some countries.

The SonoSite X-Porte ultrasound system contains an internal IEEE 802.11 transmitter that uses the Industrial, Scientific, and Medical (ISM) frequency bands from 2.412 to 2.484 GHz and/or 5.15 to 5.825 GHz. The transmitter implements three different methods of transmission.

- ▶ IEEE 802.11b with Direct Sequence Spread Spectrum (DSSS) at 16 dBm \pm 2.0 dBm @ 11 Mbps
- ▶ IEEE 802.11g with Orthogonal Frequency Division Multiplexing (OFDM) at 13 dBm \pm 2.0 dBm @ 54 Mbps
- ▶ IEEE 802.11n with Orthogonal Frequency Division Multiplexing (OFDM) at 12 dBm \pm 2.0 dBm (802.11gn) @ MCS7

Three different external USB transmitters may be used:

- ▶ The first USB transmitter implements three different methods of transmission:
 - ▶ IEEE 802.11b with Direct Sequence Spread Spectrum (DSSS) at 17 dBm \pm 2.0 dBm @ 11 Mbps
 - ▶ IEEE 802.11g with Orthogonal Frequency Division Multiplexing (OFDM) at 14 dBm \pm 2.0 dBm @ 54 Mbps
 - ▶ IEEE 802.11n Orthogonal Frequency Division Multiplexing (OFDM) at 14 dBm \pm 2.0 dBm @ MCS7
- ▶ The second USB transmitter implements three different methods of transmission:
 - ▶ IEEE 802.11b with Direct Sequence Spread Spectrum (DSSS) at 19 dBm @ 54 Mbps
 - ▶ IEEE 802.11g with Orthogonal Frequency Division Multiplexing (OFDM) at 16 dBm @ 54 Mbps
 - ▶ IEEE 802.11n Orthogonal Frequency Division Multiplexing (OFDM) at 15 dBm @ 150 Mbps
- ▶ The third USB transmitter implements ISM frequency bands from 2.400 to 2.4835 GHz, and from 5.100 to 5.800 GHz. The module implements four different methods of transmission:
 - ▶ IEEE 802.11a (5.150 to 5.850GHz) with Orthogonal Frequency Division Multiplexing (OFDM) at 12 dBm \pm 2 dBm @ 54 Mbps
 - ▶ IEEE 802.11b with Direct Sequence Spread Spectrum (DSSS) at 16 dBm \pm 2 dBm @ 11 Mbps
 - ▶ IEEE 802.11g with Orthogonal Frequency Division Multiplexing (OFDM) at 12 dBm \pm 2 dBm @ 54 Mbps
 - ▶ IEEE 802.11n with Orthogonal Frequency Division Multiplexing (OFDM) at 12 dBm \pm 2 dBm @ 65 Mbps

Electrostatic discharge

WARNING

Unless following ESD precautionary procedures, do not connect to or touch (with body or hand-held tools) pins (contacts) of connectors that have the ESD Sensitive Devices label:

Caution

Electrostatic discharge (ESD), or static shock, is a naturally occurring phenomenon. ESD is common in conditions of low humidity, which can be caused by heating or air conditioning. ESD is a discharge of the electrical energy from a charged body to a lesser or non-charged body. The degree of discharge can be significant enough to cause damage to a transducer or an ultrasound system. The following precautions can help reduce ESD: anti-static spray on carpets, anti-static spray on linoleum, and anti-static mats.

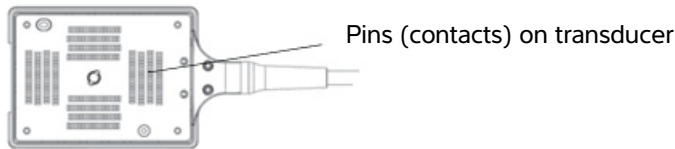

Electrostatic sensitive devices label

Figure 1 The transducer connector is an example of an electrostatically-sensitive device.

ESD precautionary procedures include the following:

- ▶ All staff involved must receive training about ESD, including the following at a minimum: an explanation of the ESD warning symbol, ESD precautionary procedures, an introduction to the physics of electrostatic charge, the voltage levels that can occur in normal practice, and the damage that can occur to electronic components if equipment is touched by an individual who is electrostatically charged (IEC 60601-1-2:2007, section 5.2.1.2 d, e).
- ▶ Prevent the buildup of electrostatic charge. For example, use humidification, conductive floor coverings, non-synthetic clothing, ionizers, and minimizing insulating materials.
- ▶ Discharge your body to earth.
- ▶ Use a wrist strap to bond yourself to the ultrasound system or to earth.

Separation distance

Recommended separation distances between portable and mobile RF communications equipment and the SonoSite X-Porte ultrasound system

WARNING

Portable RF communications equipment (including peripherals, such as antenna cables and external antennas) should be used no closer than 30 cm (12 inches) to any part of the SonoSite X-Porte ultrasound system, including cables specified by the manufacturer. Otherwise, degradation of the performance of this equipment could result.

The SonoSite X-Porte ultrasound system is intended for use in an electromagnetic environment in which radiated radio frequency (RF) disturbances are controlled. The customer or the user of the SonoSite X-Porte ultrasound system can help prevent electromagnetic interference by maintaining a minimum distance between portable and mobile RF communications equipment (transmitters) and the SonoSite X-Porte ultrasound system as recommended below, according to the maximum output power of the communications equipment.

Table 9-1: Separation distance

Rated maximum output power of transmitter (Watts)	Separation distance according to frequency of transmitter (m)		
	150 kHz to 80 MHz $d=1.2 \sqrt{P}$	80 MHz to 800 MHz $d=1.2 \sqrt{P}$	800 MHz to 2.7 GHz $d=2.3 \sqrt{P}$
0.01	0.12	0.12	0.23
0.1	0.38	0.38	0.73
1	1.2	1.2	2.3
10	3.8	3.8	7.3
100	12	12	23

For transmitters rated at a maximum output power not listed above, the recommended separation distance (d) in meters (m) can be estimated using the equation applicable to the frequency of the transmitter, where P is the maximum output power rating of the transmitter in watts (W) according to the transmitter manufacturer.

Compatible accessories and peripherals

FUJIFILM SonoSite has tested the SonoSite X-Porte ultrasound system with the following accessories and peripherals and has demonstrated compliance to the requirements of IEC 60601-1-2:2007 and IEC 60601-1-2:2014.

You may use these FUJIFILM SonoSite accessories and third-party peripherals with the SonoSite X-Porte ultrasound system.

WARNINGS

- ▶ Use of the accessories with medical systems other than the SonoSite X-Porte ultrasound system may result in increased emissions or decreased immunity of the medical system.
- ▶ Use of accessories other than those specified may result in increased emissions or decreased immunity of the ultrasound system.

Table 9-2: System components and compatible accessories

Description	Maximum cable length
D2xp transducer ^a	5.5 ft / 1.7 m
C11xp transducer ^a	6.0 ft / 1.8 m
C35xp transducer ^a	5.5 ft / 1.7 m
C60xp transducer ^a	5.7 ft / 1.7 m
HFL38xp transducer ^a	5.7 ft / 1.7 m
HFL50xp transducer ^a	5.7 ft / 1.7 m
HSL25xp transducer ^a	7.5 ft / 2.3 m
ICTxp transducer ^a	5.7 ft / 1.7 m
L25xp transducer ^a	7.5 ft / 2.3 m
L38xp transducer ^a	5.5 ft / 1.7 m
P10xp transducer ^a	6.0 ft / 1.8 m
P21xp transducer ^a	6.0 ft / 1.8 m
rP19xp transducer ^a	6.0 ft / 1.8 m
TEExp transducer ^a	7.1 ft / 2.2 m

Table 9-2: System components and compatible accessories (continued)

Description	Maximum cable length
Bar code scanner	4.8 ft/ 1.5 m
Batteries (set of 3)	-
Clinical monitor	-
Dock	-
DVR USB flash memory (64 GB)	-
ECG lead wires	24 in / 0.6 m (USA/Japan) 24 in / 0.6 m (EU)
ECG module	5.8 ft / 1.8 m (USA) 5.8 ft / 1.8 m (Japan) 5.8 ft / 1.8 m (EU)
ECG slave cable and slave cable adapter	8 ft/2.4 m
Ethernet cable	49.2 ft / 15 m
Footswitch	10 ft / 3 m
Kensington security cable	6 ft / 1.8 m
PowerPark Stand Module	-
PowerPark Docking Station	-
Mobile Printer (black and white)	-
AC Printer (black and white)	-
SPMU (Stand Power Management Unit)	-
Stand	-
Stand power cord	10 ft / 3.1 m
Touch control panel	-
Triple Transducer Connect	-
Ultrasound engine	-
USB flash memory (16 GB)	-
USB flash memory (32 GB)	-
USB flash memory (64 GB)	-

Table 9-2: System components and compatible accessories (continued)

Description	Maximum cable length
USB Wireless Adapter (no cable)	-
USB Wireless Adapter (cable required)	1.0 ft / 0.3 m
Isolation transformer (desktop configuration only) ^b	-
Power cord, isolation transformer (desktop configuration only)	6 ft / 1.8 m Monitor pedestal mount (desktop configuration only)
Power supply, monitor (desktop configuration only)	6 ft / 1.8
Power supply (engine, desktop configuration only)	4 ft / 1.2 m
Power cords (engine and monitor, desktop configuration only)	3.3 ft / 1 m
Mouse (desktop configuration only)	6 ft / 1.8 m
Digital video cable (desktop configuration only)	22.5 in / 0.57 m

^aFor transducers, maximum cable length is measured between the strain reliefs. The stated lengths do not include the lengths of cable in the following locations: underneath the strain reliefs, inside the transducer enclosure, or inside the transducer connector.

^bBefore you assemble the SonoSite X-Porte Desktop, you must configure the input and output voltages on the isolation transformer. Incorrect voltage settings can cause damage to the equipment. For instructions, see the *Toroid Superior Transformers Voltage Selections W series IsoBox*, included with the isolation transformer.

Manufacturer's declaration

The tables in this section document the intended use environment and EMC compliance levels of the system. For maximum performance, ensure that the system is used in the environments described in these tables.

The system is intended for use in the electromagnetic environment specified below.

Table 9-3: Manufacturer's Declaration – Electromagnetic Emissions per IEC 60601-1-2:2007 and IEC 60601-1-2:2014

Emissions test	Compliance	Electromagnetic environment
RF emissions CISPR 11	Group 1	The SonoSite X-Porte ultrasound system uses RF energy only for its internal function. Therefore, its RF emissions are very low and are not likely to cause any interference in nearby electronic equipment.
RF emissions CISPR 11	Class A	The SonoSite X-Porte ultrasound system is suitable for use in all establishments other than domestic and those directly connected to the public low-voltage power supply network which supplies buildings used for domestic purposes.
Harmonic emissions IEC 61000-3-2	Class A	
Voltage fluctuations/ flicker emissions IEC 61000-3-3	Complies	

The system is intended for use in the electromagnetic environment specified below.

Table 9-4: Manufacturer's Declaration – Electromagnetic Immunity per IEC 60601-1-2:2014

Immunity test	IEC 60601 test level	Compliance level	Electromagnetic environment
Electrostatic discharge (ESD) IEC 61000-4-2	± 8.0 kV contact, ± 2.0 kV, ± 4.0 kV, ± 8.0 kV ± 15 kV air	± 8.0 kV contact, ± 2.0 kV, ± 4.0 kV, ± 8.0 kV ± 15 kV air	Floors should be wood, concrete or ceramic tile. If floors are covered with synthetic material, the relative humidity should be at least 30%.
Electrical fast transient burst IEC 61000-4-4	± 2 kV on the mains ± 1 kV on signal lines	± 2 kV on the mains ± 1 kV on signal lines	Mains power quality should be that of a typical commercial or hospital environment.

Table 9-4: Manufacturer’s Declaration – Electromagnetic Immunity per IEC 60601-1-2:2014

Immunity test	IEC 60601 test level	Compliance level	Electromagnetic environment
Surge IEC 61000-4-5	± 1 kV line(s) to line(s) ± 2 kV line(s) to earth	± 1 kV line(s) to line(s) ± 2 kV line(s) to earth	Mains power quality should be that of a typical commercial or hospital environment.
Voltage dips, short interruptions and voltage variations on power supply input lines IEC 61000-4-11	0% U_T for 0.5 cycle 0% U_T for 1 cycles 70% U_T (30% dip in U_T) for 500 msec <5% U_T (>95% dip in U_T) for 5s	0% U_T for 0.5 cycle 0% U_T for 1 cycles 70% U_T (30% dip in U_T) for 500 msec <5% U_T (>95% dip in U_T) for 5s	Mains power quality should be that of a typical commercial or hospital environment. If the user of the FUJIFILM SonoSite ultrasound system requires continued operation during power mains interruptions, it is recommended that the FUJIFILM SonoSite ultrasound system be powered from an uninterruptible power supply or a battery.
Power frequency magnetic field IEC 61000-4-8	30 A/m	30 A/m	If image distortion occurs, it may be necessary to position the FUJIFILM SonoSite ultrasound system further from sources of power frequency magnetic fields or to install magnetic shielding. The power frequency magnetic field should be measured in the Intended installation location to assure that it is sufficiently low.
Conducted RF IEC 61000-4-6	3 Vrms 150 kHz to 80 MHz 6 Vrms in ISM bands	3 Vrms 6 Vrms in ISM bands	Portable and mobile RF communications equipment should be used no closer to any part of the FUJIFILM SonoSite ultrasound system including cables, than the recommended separation distance calculated from the equation applicable to the frequency of the transmitter. Recommended Separation Distance $d = 1.2 \sqrt{P}$

Table 9-4: Manufacturer’s Declaration – Electromagnetic Immunity per IEC 60601-1-2:2014

Immunity test	IEC 60601 test level	Compliance level	Electromagnetic environment
Radiated RF IEC 61000-4-3	3 V/m 80 MHz to 2.7 GHz	3 V/m 80 MHz to 2.7 GHz	$d = 1.2 \sqrt{P}$ 80 MHz to 800 MHz $d = 2.3 \sqrt{P}$ 800 MHz to 2,7 GHz Where P is the maximum output power rating of the transmitter in watts (W) according to the transmitter manufacturer and d is the recommended separation distance in meters (m). Field strengths from fixed RF transmitters, as determined by an electromagnetic Site survey ^a , should be less than the compliance level in each frequency range ^b . Interference may occur in the vicinity of equipment marked with the following symbol:  (IEC 60417 No. 417-IEC-5140: “Source of non-ionizing radiation”)
Proximity fields from wireless communications equipment IEC 61000-4-3	Per 60601-1-2:2014 Table 9	Per 60601-1-2:2014 Table 9	

^aField strengths from fixed transmitters such as base stations for radio (cellular/cordless) telephones and land mobile radios, amateur radio, AM and FM radio broadcast and TV broadcast cannot be predicted theoretically with accuracy. To assess the electromagnetic environment due to fixed RF transmitters, an electromagnetic site survey should be considered. If the measured field strength in the location in which the FUJIFILM SonoSite ultrasound system is used exceeds the applicable RF compliance level above, the FUJIFILM SonoSite ultrasound system should be observed to verify normal operation. If abnormal performance is observed, additional measures may be necessary, such as re-orienting or relocating the FUJIFILM SonoSite ultrasound system.

^bOver the frequency range 150 kHz to 80 MHz, field strengths should be less than 3 V/m.

Table 9-5: Manufacturer’s Declaration - Electromagnetic Immunity per IEC 60601-1-2:2007

Immunity test	IEC 60601 test level	Compliance level	Electromagnetic environment
Electrostatic discharge (ESD) IEC 61000-4-2	± 2.0 kV, ± 4.0 kV, ± 6.0 kV contact ± 2.0 kV, ± 4.0 kV, ± 8.0 kV air	± 2.0 kV, ± 4.0 kV, ± 6.0 kV contact ± 2.0 kV, ± 4.0 kV, ± 8.0 kV air	Floors should be wood, concrete or ceramic tile. If floors are covered with synthetic material, the relative humidity should be at least 30%.
Electrical fast Transient burst IEC 61000-4-4	± 2 kV on the mains ± 1 kV on signal lines	± 2 kV on the mains ± 1 kV on signal lines	Mains power quality should be that of a typical commercial or hospital environment.
Surge IEC 61000-4-5	± 1 kV line(s) to line(s) ± 2 kV line(s) to earth	± 1 kV line(s) to line(s) ± 2 kV line(s) to earth	Mains power quality should be that of a typical commercial or hospital environment.
Voltage dips, short interruptions and voltage variations on power supply input lines IEC 61000-4-11	<5% U_T (>95% dip in U_T) for 0.5 cycle 40% U_T (60% dip in U_T) for 5 cycles 70% U_T (30% dip in U_T) for 25 cycles <5% U_T (>95% dip in U_T) for 5s	<5% U_T (>95% dip in U_T) for 0.5 cycle 40% U_T (60% dip in U_T) for 5 cycles 70% U_T (30% dip in U_T) for 25 cycles <5% U_T (>95% dip in U_T) for 5s	Mains power quality should be that of a typical commercial or hospital environment. If the user of the FUJIFILM SonoSite ultrasound system requires continued operation during power mains interruptions, it is recommended that the FUJIFILM SonoSite ultrasound system be powered from an uninterruptible power supply or a battery.
Power frequency magnetic field IEC 61000-4-8	3 A/m	3 A/m	If image distortion occurs, it may be necessary to position the FUJIFILM SonoSite ultrasound system further from sources of power frequency magnetic fields or to install magnetic shielding. The power frequency magnetic field should be measured in the Intended installation location to assure that it is sufficiently low.

Table 9-5: Manufacturer’s Declaration – Electromagnetic Immunity per IEC 60601-1-2:2007

Immunity test	IEC 60601 test level	Compliance level	Electromagnetic environment
Conducted RF IEC 61000-4-6	3 Vrms 150 kHz to 80 MHz	3 Vrms	<p>Portable and mobile RF communications equipment should be used no closer to any part of the FUJIFILM SonoSite ultrasound system including cables, than the recommended separation distance calculated from the equation applicable to the frequency of the transmitter.</p> <p>Recommended Separation Distance $d = 1.2 \sqrt{P}$</p>
Radiated RF IEC 61000-4-3	3 V/m 80 MHz to 2.5 GHz	3 V/m	<p>$d = 1.2 \sqrt{P}$ 80 MHz to 800 MHz $d = 2.3 \sqrt{P}$ 800 MHz to 2,5 GHz</p> <p>Where P is the maximum output power rating of the transmitter in watts (W) according to the transmitter manufacturer and d is the recommended separation distance in meters (m).</p> <p>Field strengths from fixed RF transmitters, as determined by an electromagnetic Site survey^a, should be less than the compliance level in each frequency range^b.</p> <p>Interference may occur in the vicinity of equipment marked with the following symbol:</p>  <p>(IEC 60417 No. 417-IEC-5140: “Source of non-ionizing radiation”)</p>

Table 9-5: Manufacturer’s Declaration – Electromagnetic Immunity per IEC 60601-1-2:2007

Immunity test	IEC 60601 test level	Compliance level	Electromagnetic environment
<p>^aField strengths from fixed transmitters such as base stations for radio (cellular/cordless) telephones and land mobile radios, amateur radio, AM and FM radio broadcast and TV broadcast cannot be predicted theoretically with accuracy. To assess the electromagnetic environment due to fixed RF transmitters, an electromagnetic site survey should be considered. If the measured field strength in the location in which the FUJIFILM SonoSite ultrasound system is used exceeds the applicable RF compliance level above, the FUJIFILM SonoSite ultrasound system should be observed to verify normal operation. If abnormal performance is observed, additional measures may be necessary, such as re-orienting or relocating the FUJIFILM SonoSite ultrasound system.</p> <p>^bOver the frequency range 150 kHz to 80 MHz, field strengths should be less than 3 V/m.</p>			

FCC Caution: This equipment has been tested and found to comply with the limits for a Class A digital device, pursuant to part 15 of the FCC rules. These limits are designed to provide reasonable protection against harmful interference when the equipment is operated in a commercial environment. This equipment generates, uses, and can radiate radio frequency energy and, if not installed and used in accordance with the instruction manual, may cause harmful interference to radio communications. Operation of this equipment in a residential area is likely to cause harmful interference in which case the user will be required to correct the interference at his own expense.

Immunity testing requirements

The SonoSite X-Porte ultrasound system complies with the essential performance requirements specified in IEC 60601-1-2 and IEC 60601-2-37. Results of immunity testing show that the SonoSite X-Porte ultrasound system meets these requirements and is free from the following:

- ▶ Noise on a waveform or artifacts or distortion in an image or error of a displayed numerical value that cannot be attributed to a physiological effect and that may alter the diagnosis
- ▶ Display of incorrect numerical values associated with the diagnosis to be performed
- ▶ Display of incorrect safety related indications
- ▶ Production of unintended or excessive ultrasound output
- ▶ Production of unintended or excessive transducer assembly surface temperature
- ▶ Production of unintended or uncontrolled motion of transducer assemblies intended for intracorporeal use

Labeling symbols

The following symbols are used on the products, packaging, and containers.

Table 9-6: Standards labeling symbols





Symbol	Title	Standards development organization (SDO)	Reference number	Description
	Manufacturer	ISO 15223-1:2016 Medical devices – symbols to be used with medical device labels, labeling, and information to be supplied – Part 1: General requirements	5.1.1	Indicates the medical device manufacturer, as EU directives 90/385/EEC, 93/42/EEC and 98/79/EC
	Date of manufacture	ISO 7000- Graphical symbols for Use on Equipment	5.1.3	To indicate the date on which a product was manufactured
	Serial Number	ISO 15223-1:2016 Medical devices – symbols to be used with medical device labels, labeling, and information to be supplied – Part 1: General requirements	5.1.7	Indicates the manufacturer's serial number so that a specific medical device can be identified
	Catalog Number	ISO 15223-1:2016 Medical devices – symbols to be used with medical device labels, labeling, and information to be supplied – Part 1: General requirements	5.1.6	Indicates the manufacturer's catalogue number so that the medical device can be identified

Table 9-6: Standards labeling symbols





Symbol	Title	Standards development organization (SDO)	Reference number	Description
	Caution	ISO 15223-1:2016 Medical devices – symbols to be used with medical device labels, labeling, and information to be supplied – Part 1: General requirements	5.4.4	Indicates the need for the user to consult the instructions for use for important cautionary information such as warnings and precautions that cannot for a variety of reasons, be presented on the medical device itself
	Fragile handle with care	ISO 15223-1:2016 Medical devices – symbols to be used with medical device labels, labeling, and information to be supplied – Part 1: General requirements	5.3.1	Indicates a medical device that can be broken or damaged if not handled carefully
	Keep dry	ISO 15223-1:2016 Medical devices – symbols to be used with medical device labels, labeling, and information to be supplied – Part 1: General requirements	5.3.4	Indicates a medical device that needs to be protected from moisture
	Temperature limit	ISO 15223-1:2016 Medical devices – symbols to be used with medical device labels, labeling, and information to be supplied – Part 1: General requirements	5.3.7	Indicates the temperature limits to which the medical device can be safely exposed

Table 9-6: Standards labeling symbols





Symbol	Title	Standards development organization (SDO)	Reference number	Description
	Atmospheric pressure limitations	ISO 15223-1:2016 Medical devices – symbols to be used with medical device labels, labeling, and information to be supplied – Part 1: General requirements	5.3.9	Indicates the range of atmospheric pressure to which the medical device can be safely expose
	Humidity limitation	ISO 15223-1:2016 Medical devices – symbols to be used with medical device labels, labeling, and information to be supplied – Part 1: General requirements	5.3.8	Indicates the range of humidity to which the medical device can be safely exposed
	Stacking limit by number	ISO 7000:2014 Graphical symbols for use on equipment	2403	Do not stack over n high, where n represents the number on the label.
	Refer to instruction manual/booklet	IEC 60601-1 Medical electrical equipment Part 1: General requirements for basic safety and essential performance	D.2-10	Follow instructions for use (used in accordance with IEC 60601-1)
	Consult instructions for use	ISO 15223-1:2016 Medical devices – symbols to be used with medical device labels, labeling, and information to be supplied – Part 1: General requirements	5.4.3	Indicates the need for the user to consult the instructions for use

Table 9-6: Standards labeling symbols





Symbol	Title	Standards development organization (SDO)	Reference number	Description
	Non-ionizing electromagnetic radiation	IEC 60601-1-2:2007 Medical electrical equipment — Part 1-2: General requirements for basic safety and essential performance — Collateral standard: Electromagnetic compatibility — Requirements and tests	5.1.1	To indicate generally elevated, potentially hazardous, levels of non-ionizing radiation, or to indicate equipment or systems e.g. in the medical electrical area that include RF transmitters or that intentionally apply RF electromagnetic energy for diagnosis or treatment
	Corrugated recycle	—	—	Shipping box is made of corrugated cardboard and should be recycled accordingly
	21 Part 15	Federal Communications Commission (FCC) Declaration of conformity	Federal Communications Commission	FCC—Tested to Federal Communications Commission requirements. Device complies with relevant FCC regulations for electronic devices.
	RESY – Recycling Symbol	—	—	Paper recycle
	Conformité Européene Notified Body Reference No.: 2797	Council Directive 93/42/ EEC	Article 17 Annex XII	Indicates European technical conformity and identification of notified body responsible for implementation of the procedures set out in Annexes II, IV, V, and VI

Table 9-6: Standards labeling symbols





Symbol	Title	Standards development organization (SDO)	Reference number	Description
	Regulatory Compliance Mark (RCM)	AS/NZS3820	—	Indicates C-Tick-Regulatory Compliance Mark for Australia and New Zealand Device complies with relevant Australian and New Zealand regulations for electronic devices.
	Recycle: Electronic Equipment	BS EN 50419:2016 Marking of Electrical and Electronic Equipment in accordance with Directive 2012/19/EU (WEEE)	Annex IX	Do Not Throw in Trash
	Alternating current	ISO 7000 / IEC 60417 Graphical symbols for use on equipment	5032	Indicates on the rating plate, that the equipment is suitable for alternating current only, in order to identify appropriate terminals
	Batch code, date code, or lot code type of control number	ISO 15223-1 Medical devices - Symbols to be used with medical device labels, labelling and information to be supplied - Part 1: General Requirements	5.1.5	Indicates manufacturer's batch code so that the batch or lot can be identified
	Biological risk	ISO 7010 - Graphical symbols -- Safety colors and safety signs	W009	To warn of biological Hazard

Table 9-6: Standards labeling symbols





Symbol	Title	Standards development organization (SDO)	Reference number	Description
	INMETRO Safety Symbols	—	—	Indicates Brazil - Accredited certification body by the National Institute of Metrology Standardization and Industrial Quality (INMETRO)
	Canadian Standard Association Certification Mark	—	—	CSA certification mark signifying that the product complies with the applicable CSA and ANSI/UL requirements and is authorized for use in Canada and the US
	Canadian Standards Association component certification mark	—	—	CSA certification mark signifying that the product complies with the applicable CSA and ANSI/UL requirements and is authorized for use in Canada and the US
	Direct current (DC)	—	—	—
	Electrostatic sensitive devices	IEC 60417:2002 Graphical Symbols For Use On Equipment	5134	Indicates packages containing electrostatic sensitive devices, or identifies a device or a connector that has not been tested for immunity to electrostatic discharge
GEL	Gel	—	—	—

Table 9-6: Standards labeling symbols



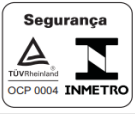



Symbol	Title	Standards development organization (SDO)	Reference number	Description
	Sterilized using irradiation	ISO 15223-1 Medical devices - Symbols to be used with medical device labels, labeling and information to be supplied - Part 1: General Requirements	5.2.4	Indicates a medical device that has been sterilized using irradiation
	Sterilized using ethylene oxide	ISO 15223-1 Medical devices - Symbols to be used with medical device labels, labeling and information to be supplied - Part 1: General Requirements	5.2.3	Indicates a medical device that has been sterilized using ethylene oxide
	Caution hot	ISO 7000 / IEC 60417 Graphical symbols for use on equipment	5041	Indicates that the marked item can be hot and should not be touched without taking care
	Caution, static magnetic field hazard	ISO 7000 / IEC 60417 Graphical symbols for use on equipment	6204	Identifies areas with potentially hazardous static magnetic fields and forces in an installation
	Degree of ingress protection provided by enclosure	IEC 60601-1 Medical electrical equipment Part 1: General requirements for basic safety and essential performance	D.3	Protected against the effects of temporary immersion in water. Submersible Protected against the effects of temporary immersion.
	Degree of ingress protection provided by enclosure	IEC 60601-1 Medical electrical equipment Part 1: General requirements for basic safety and essential performance		Protected against the effects of temporary immersion in water. Water-Tight Equipment Protected against the effects of extended immersion

Table 9-6: Standards labeling symbols











Symbol	Title	Standards development organization (SDO)	Reference number	Description
	—	—	—	Indicates handle with care
	—	—	—	Indicates follow manufacturer's instructions for disinfecting time
	—	—	—	Indicates disinfect transducer
	Type BF applied parts	IEC 60601-1 Medical electrical equipment Part 1: General requirements for basic safety and essential performance	D.2-10	Identifies type BF applied part complying with IEC 60601-1
	Defibrillation-proof type CF applied part	IEC 60601-1 Medical electrical equipment Part 1: General requirements for basic safety and essential performance	D.1-27	Identifies a defibrillation-proof type CF applied part complying with IEC 60601-1
	China Pollution Control (10)	ISO 7000:2014 Graphical symbols for use on equipment	1135	Pollution Control Logo. (Applies to all parts/products listed in the China RoHS disclosure table. May not appear on the exterior of some parts/products because of space limitations.)

Table 9-6: Standards labeling symbols

Symbol	Title	Standards development organization (SDO)	Reference number	Description
	China Compulsory Certificate mark (“CCC Mark”). A compulsory safety mark for compliance to Chinese national standards for many products sold in the People’s Republic of China.	—	—	—
	European community authorized representative	ISO 15223-1 Medical devices - symbols to be used with medical device labels, labelling and information to be supplied	5.1.2	Indicates the Authorized representative in the European Community
				Equipotentiality
	—	—	—	Pushing Prohibited Do not push on monitor. System may tip due to pushing or leaning on the monitor.
	Maximum weight load	IEC 60601-1 Medical Electrical Equipment Part 1: General requirements for basic	7.2.21	Indicates total weight of the equipment, including the safe working load

Specifications

For information on accessories and peripherals, see “[Compatible accessories and peripherals](#)” on page 9–15.

Dimensions

System

Weight (includes safe working load) 162.3 lbs. (73.6 kg)

Storage bin capacity 12.1 lbs. (5.5 kg)

Stand

	<u>First configuration</u>	<u>Second configuration</u>
Length	26.4 in. (67.1 cm)	26.4 in. (67.1 cm)
Width	21.2 in. (58.3 cm)	21.2 in. (58.3 cm)
Height (max with monitor up)	64 in. (162.6 cm)	65 in. (165.6 cm)
Height (min with monitor down)	42.2 in. (107.2 cm)	42.2 in. (107.2 cm)

Clinical monitor

	<u>First configuration</u>	<u>Second configuration</u>
Length (exterior dimension)	18.8 in. (47.8 cm)	20.2 in. (51.4 cm)
Height (exterior dimension)	14.2 in. (36 cm)	14.33 in. (36.4 cm)
Diagonal (viewable area)	19 in. (48.3 cm)	19.9 in. (50.6 cm)
Resolution	1680 x 1050	1728 x 1080

Touch panel

Length (exterior dimension)	16.1 in. (40.8 cm)
Height (exterior dimension)	10.2 in. (25.8 cm)
Diagonal (viewable area)	12.1 in. (30.7 cm)

Environmental limits

Note

The temperature, pressure, and humidity limits apply only to the ultrasound system and transducers.

Operating (system and transducer)

10–40°C (50–104°F), 15–95% R.H.

800 to 1060hPa (0.79 to 1.05 ATM)

Shipping and storage (system and transducer)

-35–60°C (-31–140°F), 15–95% R.H.

500 to 1060hPa (0.5 to 1.05 ATM)

Electrical

Power Supply Input: 100-240 V, 8.0-3.0 A, 50-60 Hz

Imaging modes

- ▶ 2D (256 gray shades)
- ▶ Color Power Doppler (CPD) (256 colors)
- ▶ Color Doppler (Color) (256 colors)
- ▶ M Mode
- ▶ Continuous wave (CW) Doppler

Additionally, the system includes advanced imaging technologies:

- ▶ Tissue Doppler Imaging (TDI)
- ▶ Tissue Harmonic Imaging (THI)

Image and video clip storage capacity

The number of images and video clips you can save depends on imaging mode and file format.

Standards

Electromechanical safety standards

Table 9-7: Electromechanical safety standards

Standard	Description
ANSI/AAMI ES60601-1:2005/(R) 2012, and A1:2012	Medical electrical equipment, Part 1: General requirements for basic safety and essential performance (Edition 3.1)
CAN/CSA C22.2 No. 60601-1:2014	Medical electrical equipment – Part 1: General Requirements for Basic Safety and Essential Performance (Edition 3.1)
IEC 60601-1:2012	Medical electrical equipment – Part 1: General Requirements for Basic Safety and Essential Performance (Edition 3.1)
IEC 60601-2-37:2015 (Ed. 2.1)	Medical Electrical Equipment – Part 2-37: Particular requirements for the basic safety and essential performance of ultrasonic medical diagnostic and monitoring equipment (Edition 2.0)
IEC 60601-1-6:2013	Medical Electrical Equipment part 1-6: General requirements for basic safety and essential performance – Collateral Standard: Usability (Edition 3.1b)
CSA C22.2 60601-2-37:08	Medical Electrical Equipment – Part 2-37: Particular requirements for the basic safety and essential performance of ultrasonic medical diagnostic and monitoring equipment (Adopted IEC 60601-2-37:2007, Edition 2.0)
CSA C22.2 60601-1-6:11+A1	Medical Electrical Equipment part 1-6: General requirements for basic safety and essential performance – Collateral Standard: Usability (Adopted IEC 60601-1-6:2013, Edition 3.1)

EMC standards classification

Table 9–8: EMC standards classification

Standard	Description
IEC 60601-1-2:2007 and IEC 60601-1-2:2014	Medical Electrical Equipment. General Requirements for Basic Safety and Essential Performance-Collateral Standard. Electromagnetic Compatibility. Requirements and Tests.
CISPR 11 Edition 6.1:2016	Industrial, Scientific, and Medical (ISM) Radio-Frequency Equipment Electromagnetic Disturbance Characteristics-Limits and Methods of Measurement.

The Classification for the ultrasound system, docking system, accessories, and peripherals when configured together is: Group 1, Class A.

DICOM standard

NEMA PS 3.15: 2000, Digital Imaging and Communications in Medicine (DICOM)-Part 15: Security Profiles.

The system conforms to the DICOM standard as specified in the SonoSite X-Porte DICOM Conformance Statement, available at www.sonosite.com. This statement provides information about the purpose, characteristics, configuration, and specifications of the network connections supported by the system.

HIPAA standard

The system includes security settings that help you to meet the applicable security requirements listed in the HIPAA standard. Users are ultimately responsible for ensuring the security and protection of all electronic protected health information collected, stored, reviewed, and transmitted on the system.

The Health Insurance and Portability and Accountability Act, Pub.L. No. 104-191 (1996). 45 CFR 160, General Administrative Requirements.

45 CFR 164, Security and Privacy.

CHAPTER 10

Acoustic output

This section contains information about the ALARA (as low as reasonably achievable) principle, the output display standard, and acoustic power and intensity tables. The information applies to the ultrasound system, transducer, accessories, and peripherals.

ALARA principle

ALARA is the guiding principle for the use of diagnostic ultrasound. Sonographers and other qualified ultrasound users, using good judgment and insight, determine the exposure that is “as low as reasonably achievable.” There are no set rules to determine the correct exposure for every situation. The qualified ultrasound user determines the most appropriate way to keep exposure low and bioeffects to a minimum, while obtaining a diagnostic examination.

A thorough knowledge of the imaging modes, transducer capability, system setup and scanning technique is necessary. The imaging mode determines the nature of the ultrasound beam. A stationary beam results in a more concentrated exposure than a scanned beam, which spreads that exposure over that area. The transducer capability depends upon the frequency, penetration, resolution, and field of view. The default system presets are reset at the start of each new patient. It is the scanning technique of the qualified ultrasound user along with patient variability that determines the system settings throughout the exam.

The variables which affect the way the qualified ultrasound user implements the ALARA principle include patient body size, location of the bone relative to the focal point, attenuation in the body, and ultrasound exposure time. Exposure time is an especially useful variable, because the qualified ultrasound user can control it. The ability to limit the exposure over time supports the ALARA principle.

Applying the ALARA principle

The system imaging mode selected by the qualified ultrasound user is determined by the diagnostic information required. 2D imaging provides anatomical information; CPD imaging provides information about the energy or amplitude strength of the Doppler signal over time at a given anatomical location and is used for detecting the presence of blood flow;

Color imaging provides information about the energy or amplitude strength of the Doppler signal over time at a given anatomical location and is used for detecting the presence, velocity, and direction of blood flow; Tissue Harmonic Imaging uses higher received frequencies to reduce clutter, artifact, and improve resolution on the 2D image. Understanding the nature of the imaging mode used allows the qualified ultrasound user to apply the ALARA principle.

Prudent use of ultrasound means limiting ultrasound to situations in which it is medically useful and limiting patient exposure to the lowest ultrasound output for the shortest time necessary to achieve acceptable diagnostic results. Although there are no direct user controls for acoustic output, users can indirectly control output by varying depth. Decisions that support prudent use are based on the type of patient, exam type, patient history, ease or difficulty of obtaining diagnostically useful information, and potential localized heating of the patient due to transducer surface temperature. See [“Transducer surface temperature rise”](#) on page 10-8. In the event of a device malfunction, there are redundant controls that limit transducer power. This is accomplished by an electrical design that limits both power supply current and voltage to the transducer.

The sonographer uses the system controls to adjust image quality and limit ultrasound output. The system controls are divided into three categories relative to output: controls that directly affect output, controls that indirectly affect output, and receiver controls.

Direct, indirect, and receiver controls

Direct controls The system does not have a direct user control for output. Rather, the system has been designed to automatically adjust output to ensure that acoustic and thermal limits are not exceeded for all imaging modes. Since there is no direct user control for output, the sonographer should rely on controlling exposure time and scanning technique to implement the ALARA principle.

The system does not exceed a spatial peak temporal average intensity (ISPTA) of 720 mW/cm² for all imaging modes. The mechanical index (MI) and thermal index (TI) may exceed values greater than 1.0 on some transducers in some imaging modes. For either the Ophthalmic or Orbital exam, the acoustic output is limited to the following values: ISPTA does not exceed 50 mW/cm²; TI does not exceed 1.0, and MI does not exceed 0.23. Ultrasound users can monitor the MI and TI values on the right side of the clinical monitor and implement the ALARA principle accordingly. For more information on MI and TI, see Medical Ultrasound Safety, AIUM (a copy is included with each system) and IEC 60601-2-37 Annex “Guidance on the interpretation of TI and MI to be used to inform the operator.”

Indirect controls The controls that indirectly affect output are controls affecting imaging mode, freeze, and depth. The imaging mode determines the nature of the ultrasound beam. Freeze stops all ultrasound output but keeps the last image displayed on screen. Freeze can be used by the ultrasound user to limit exposure time while studying an image and maintaining probe position during a scan. Some controls, such as depth, show a rough correspondence with output, and may be used as a general means for indirectly reducing MI or TI. See [“Guidelines for reducing MI and TI”](#) on page 10-3.

Receiver controls The receiver controls are the gain controls. Receiver controls do not affect output. They should be used, if possible, to improve image quality before using controls that directly or indirectly affect output.

Acoustic artifacts

An acoustic artifact is information, present or absent in an image, that does not properly indicate the structure or flow being imaged. There are helpful artifacts that aid in diagnosis and those that hinder proper interpretation. Examples of artifacts include shadowing, through transmission, aliasing, reverberations, and comet tails.

For more information on detecting and interpreting acoustic artifacts, see the following reference:

Kremkau, Frederick W. *Diagnostic Ultrasound: Principles and Instruments*. 7th ed., W.B. Saunders Company, (Oct. 17, 2005).

Guidelines for reducing MI and TI

The following are general guidelines for reducing MI or TI. If multiple parameters are given, the best results may be achieved by minimizing these parameters simultaneously. In some modes, changing these parameters does not affect MI or TI. Changes to other parameters may also result in MI and TI reductions. Please note the MI and TI values on the screen. For a visual representation, see “**Clinical monitor**” on page 2-19.

Table 10-1: Guidelines for reducing MI

Transducer	Depth
C11xp	↑
C35xp	↑
C60xp	↑
HFL38xp	↑
HFL50xp	↑
HSL25xp	↑
ICTxp	↑
L25xp	↑
L38xp	↑

Table 10-1: Guidelines for reducing MI (continued)

Transducer	Depth
P10xp	↑
P21xp	↑
rP19xp	↑
TEExp	↑

↓ Decrease or lower setting of parameter to reduce MI.
 ↑ Increase or raise setting of parameter to reduce MI.

Table 10-2: Guidelines for reducing TI

Transducer	CPD settings						Depth
	Box width	Box height	Box depth	PRF	Depth	Optimize	
C11xp			↑				↓ (Depth)
C35xp			↑				↓ (Depth)
C60xp	↑		↑				↑ (Depth)
HFL38xp	↑		↑				↑ (Depth)
HFL50xp	↑		↑				↑ (Depth)
HSL25xp			↑				↑ (Depth)
ICTxp			↑				↑ (Depth)

Table 10-2: Guidelines for reducing TI (continued)

Transducer	CPD settings						Depth
	Box width	Box height	Box depth	PRF	Depth	Optimize	
L25xp			↑				↑ (Depth)
L38xp			↑				↑ (Depth)
P10xp			↑				↓ (Depth)
P21xp			↑				↑ (PRF)
rP19xp	↑			↓	↑		↑ (PRF)
TEExp			↑	↓			↑

↓ Decrease or lower setting of parameter to reduce TI.
 ↑ Increase or raise setting of parameter to reduce TI.

Output display

The system meets the AIUM (American Institute of Ultrasound in Medicine) output display standard for MI and TI (see [“Related guidance documents”](#) on page 10-8). The following table indicates for each transducer and operating mode when either the TI or MI is greater than or equal to a value of 1.0, thus requiring display.

Table 10-3: TI or MI ≥ 1.0

Transducer	Index	2D/ M Mode	CPD/ Color	PW Doppler	CW Doppler	2D/PW Doppler	2D/Color/ PW Doppler
C11xp	MI	No	No	Yes	—	—	—
	TIC, TIB, or TIS	No	No	Yes	—	—	—

Table 10-3: TI or MI ≥ 1.0 (continued)

Transducer	Index	2D/ M Mode	CPD/ Color	PW Doppler	CW Doppler	2D/PW Doppler	2D/Color/ PW Doppler
C35xp	MI	Yes	No	Yes	—	—	—
	TIC, TIB, or TIS	Yes	No	Yes	—	—	—
C60xp	MI	Yes	Yes	Yes	—	—	—
	TIC, TIB, or TIS	Yes	Yes	Yes	—	—	—
D2xp	MI	—	—	—	No	—	—
	TIC, TIB, or TIS	—	—	—	Yes	—	—
HFL38xp	MI	Yes	Yes	No	—	No	Yes
	TIC, TIB, or TIS	No	No	Yes	—	Yes	Yes
HFL50xp	MI	Yes	Yes	No	—	—	—
	TIC, TIB, or TIS	No	No	Yes	—	—	—
HSL25xp	MI	Yes	Yes	No	—	Yes	Yes
	TIC, TIB, or TIS	No	No	Yes	—	No	No
ICTxp	MI	Yes	No	Yes	—	—	—
	TIC, TIB, or TIS	No	No	Yes	—	—	—
L25xp	MI	Yes	Yes	No	—	Yes	Yes
	TIC, TIB, or TIS	No	No	Yes	—	No	No
L38xp	MI	Yes	Yes	Yes	—	Yes	Yes
	TIC, TIB, or TIS	Yes	No	Yes	—	Yes	Yes
P10xp	MI	Yes	No	Yes	No	—	—
	TIC, TIB, or TIS	Yes	Yes	Yes	Yes	—	—
P21xp	MI	Yes	Yes	Yes	No	—	—
	TIC, TIB, or TIS	Yes	Yes	Yes	Yes	—	—
rP19xp	MI	Yes	Yes	Yes	No	—	—
	TIC, TIB, or TIS	Yes	Yes	Yes	Yes	—	—

Table 10-3: TI or MI \geq 1.0 (continued)

Transducer	Index	2D/ M Mode	CPD/ Color	PW Doppler	CW Doppler	2D/PW Doppler	2D/Color/ PW Doppler
TEExp	MI	Yes	No	Yes	No	—	—
	TIC, TIB, or TIS	No	No	Yes	Yes	—	—

Even if MI is less than 1.0, the system provides a continuous real-time display of MI in all imaging modes, in increments of 0.1.

The system meets the output display standard for TI and provides a continuous real-time display of TI in all imaging modes, in increments of 0.1.

The TI consists of three user-selectable indices, and only one of these is displayed at any one time. In order to display TI properly and meet the ALARA principle, the user selects an appropriate TI based on the specific exam being performed. FUJIFILM SonoSite provides a copy of *AIUM Medical Ultrasound Safety*, which contains guidance on determining which TI is appropriate (see “**Related guidance documents**” on page on page 10-8).

MI and TI output display accuracy

The accuracy result for the MI is stated statistically. With 95% confidence, 95% of the measured MI values will be within +18% to -25% of the displayed MI value, or +0.2 of the displayed value, whichever value is larger.

The accuracy result for the TI is stated statistically. With 95% confidence, 95% of the measured TI values will be within +21% to -40% of the displayed TI value, or +0.2 of the displayed value, whichever value is larger. The values equate to +1dB to -3dB.

A displayed value of 0.0 for MI or TI means that the calculated estimate for the index is less than 0.05.

Factors that contribute to display uncertainty

The net uncertainty of the displayed indices is derived by combining the quantified uncertainty from three sources: measurement uncertainty, system and transducer variability, and engineering assumptions and approximations made when calculating the display values.

Measurement errors of the acoustic parameters when taking the reference data are the major source of error that contributes to the display uncertainty. The measurement error is described in “**Acoustic measurement precision and uncertainty**” on page 10-89.

The displayed MI and TI values are based on calculations that use a set of acoustic output measurements that were made using a single reference ultrasound system with a single reference transducer that is representative of the population of transducers of that type. The reference system and transducer are chosen from a sample population of systems and transducers taken from early production units, and they are selected based on having an acoustic output that is representative of the nominal expected acoustic output

for all transducer-system combinations that might occur. Of course every transducer-system combination has its own unique characteristic acoustic output, and will not match the nominal output on which the display estimates are based. This variability between systems and transducers introduces an error into displayed value. By doing acoustic output sampling testing during production, the amount of error introduced by the variability is bounded. The sampling testing ensures that the acoustic output of transducers and systems being manufactured stays within a specified range of the nominal acoustic output.

Another source of error arises from the assumptions and approximations that are made when deriving the estimates for the display indices. Chief among these assumptions is that the acoustic output, and thus the derived display indices, are linearly correlated with the transmit drive voltage of the transducer. Generally, this assumption is very good, but it is not exact, and thus some error in the display can be attributed to the assumption of voltage linearity.

Related guidance documents

Information for Manufacturers Seeking Marketing Clearance of Diagnostic Ultrasound Systems and Transducers, FDA, 2008.

Medical Ultrasound Safety, American Institute of Ultrasound in Medicine (AIUM), 2014. (A copy is included with each system.)

Acoustic Output Measurement Standard for Diagnostic Ultrasound Equipment, NEMA UD2-2004.

IEC 60601-2-37: 2015, "Particular requirements for the basic safety and essential performance of ultrasonic diagnostic and monitoring equipment".

Transducer surface temperature rise

The tables in this section list the measured surface temperature rise from ambient ($23^{\circ}\text{C} \pm 3^{\circ}\text{C}$) of transducers used on the ultrasound system. The temperatures were measured in accordance with IEC 60601-2-37 with controls and settings positioned to give maximum temperatures.

Table 10-4: Transducer Surface Temperature Rise, External Use ($^{\circ}\text{C}$)

Test	D2xp	C11xp	C35xp	C60xp	HFL38xp	HFL50xp	HSL25xp	L25xp	L38xp	P10xp	P21xp	rP19xp
Still air	8.8	13.5	13.4	14.8	10.4	11.1	13.8	12.8	12.9	15.4	14.7	15.8
Simulated use	3.5 ($\leq 10^{\circ}\text{C}$)	8.2 ($\leq 10^{\circ}\text{C}$)	9.1 ($\leq 10^{\circ}\text{C}$)	9.5 ($\leq 10^{\circ}\text{C}$)	7.0 ($\leq 10^{\circ}\text{C}$)	9.0 ($\leq 10^{\circ}\text{C}$)	7.9 ($\leq 10^{\circ}\text{C}$)	8.6 ($\leq 10^{\circ}\text{C}$)	9.0 ($\leq 10^{\circ}\text{C}$)	9.2 ($\leq 10^{\circ}\text{C}$)	9.5 ($\leq 10^{\circ}\text{C}$)	8.8 ($\leq 10^{\circ}\text{C}$)

Table 10-5: Transducer Surface Temperature Rise, Non-External Use (°C)

Test	ICTxp	TEExp
Still air	8.9	10.7
Simulated use	4.7 (<6°C)	3.6 (≤6°C)

Acoustic output measurement

Since the initial use of diagnostic ultrasound, the possible human biological effects (bioeffects) from ultrasound exposure have been studied by various scientific and medical institutions. In October 1987, AIUM ratified a report from its Bioeffects Committee (Bioeffects Considerations for the Safety of Diagnostic Ultrasound, J Ultrasound Med., Sept. 1988: Vol. 7, No. 9 Supplement). The report, sometimes referred to as the Stowe Report, reviewed available data on possible effects of ultrasound exposure. Another report, "Bioeffects and Safety of Diagnostic Ultrasound," dated January 28, 1993, provides more current information.

The acoustic output for this ultrasound system has been measured and calculated in accordance with "Acoustic Output Measurement Standard for Diagnostic Ultrasound Equipment" (NEMA UD2-2004), and IEC 60601-2-37: 2015, Medical electrical equipment -- Part 2-37: Particular requirements for the safety and essential performance of ultrasonic diagnostic and monitoring equipment.

***In Situ*, derated, and water value intensities**

All intensity parameters are measured in water. Since water does not absorb acoustic energy, these water measurements represent a worst case value. Biological tissue does absorb acoustic energy. The true value of the intensity at any point depends on the amount, type of tissue, and the frequency of the ultrasound passing through the tissue. The intensity value in the tissue, *In Situ*, has been estimated by using the following formula:

$$In\ Situ = Water [e^{-(0.23af)}] \text{ where:}$$

where:

In Situ = *In Situ* intensity value

Water = Water intensity value

e = 2.7183

a = attenuation factor (dB/cm MHz)

Attenuation factor (a) for various tissue types are given below:

brain = 0.53

heart = 0.66

kidney = 0.79

liver = 0.43

muscle = 0.55

l = skinline to measurement depth in cm

f = center frequency of the transducer/system/mode combination in MHz

Since the ultrasonic path during the exam is likely to pass through varying lengths and types of tissue, it is difficult to estimate the true *In Situ* intensity. An attenuation factor of 0.3 is used for general reporting purposes; therefore, the *In Situ* value commonly reported uses the formula:

$$\text{In Situ derated)} = \text{Water } e^{-(0.069lf)}$$

Since this value is not the true *In Situ* intensity, the term “derated” is used to qualify it.

The maximum derated and the maximum water values do not always occur at the same operating conditions; therefore, the reported maximum water and derated values may not be related by the *In Situ* (derated) formula. For example: a multi-zone array transducer that has maximum water value intensities in its deepest zone, but also has the smallest derating factor in that zone. The same transducer may have its largest derated intensity in one of its shallowest focal zones.

Tissue models and equipment survey

Tissue models are necessary to estimate attenuation and acoustic exposure levels *In Situ* from measurements of acoustic output made in water. Currently, available models may be limited in their accuracy because of varying tissue paths during diagnostic ultrasound exposures and uncertainties in the acoustic properties of soft tissues. No single tissue model is adequate for predicting exposures in all situations from measurements made in water, and continued improvement and verification of these models is necessary for making exposure assessments for specific exam types.

A homogeneous tissue model with attenuation coefficient of 0.3 dB/cm MHz throughout the beam path is commonly used when estimating exposure levels. The model is conservative in that it overestimates the *In Situ* acoustic exposure when the path between the transducer and site of interest is composed entirely of soft tissue. When the path contains significant amounts of fluid, as in many first and second-trimester pregnancies scanned transabdominally, this model may underestimate the *In Situ* acoustic exposure. The amount of underestimation depends upon each specific situation.

Fixed-path tissue models, in which soft tissue thickness is held constant, sometimes are used to estimate *In Situ* acoustic exposures when the beam path is longer than 3 cm and consists largely of fluid. When this model is used to estimate maximum exposure to the fetus during transabdominal scans, a value of 1 dB/cm MHz may be used during all trimesters.

Existing tissue models that are based on linear propagation may underestimate acoustic exposures when significant saturation due to non-linear distortion of beams in water is present during the output measurement.

The maximum acoustic output levels of diagnostic ultrasound devices extend over a broad range of values:

- ▶ A survey of 1990-equipment models yielded MI values between 0.1 and 1.0 at their highest output settings. Maximum MI values of approximately 2.0 are known to occur for currently available equipment. Maximum MI values are similar for real-time 2D and M Mode imaging.
- ▶ Computed estimates of upper limits to temperature elevations during transabdominal scans were obtained in a survey of 1988 and 1990 pulsed Doppler equipment. The vast majority of models yielded upper limits less than 1° and 4°C (1.8° and 7.2°F) for exposures of first-trimester fetal tissue and second-trimester fetal bone, respectively. The largest values obtained were approximately 1.5°C (2.7°F) for first-trimester fetal tissue and 7°C (12.6°F) for second-trimester fetal bone. Estimated maximum temperature elevations given here are for a “fixed path” tissue model and are for devices having ISPTA values greater than 500 mW/cm². The temperature elevations for fetal bone and tissue were computed based on calculation procedures given in Sections 4.3.2.1–4.3.2.6 in “Bioeffects and Safety of Diagnostic Ultrasound” (AIUM, 1993).

Acoustic output tables

The tables in this section indicate the acoustic output for the system and transducer combinations with a TI or MI equal to or greater than one. These tables are organized by transducer model and imaging mode. For a definition of terms used in the tables, see “[Terminology in acoustic output tables](#)” on page 10-90.

Transducer model: D2xp Operating mode: CW Doppler	10-14
Transducer model: C11xp Operating mode: 2D + M Mode	10-15
Transducer model: C11xp Operating mode: PW Doppler	10-16
Transducer model: C35xp Operating mode: 2D	10-17
Transducer model: C35xp Operating mode: 2D + M Mode	10-18
Transducer model: C35xp Operating mode: PW Doppler	10-19
Transducer model: C60xp Operating mode: 2D	10-20
Transducer model: C60xp Operating mode: 2D + M Mode	10-21
Transducer model: C60xp Operating mode: Color/CPD	10-22
Transducer model: C60xp Operating mode: PW Doppler	10-23
Transducer model: HFL38xp Operating mode: 2D	10-24
Transducer model: HFL38xp Operating mode: 2D + M Mode	10-25
Transducer model: HFL38xp Operating mode: Color/CPD	10-26
Transducer model: HFL38xp Operating mode: PW Doppler	10-27
Transducer model: HFL38xp Operating mode: 2D + PW Doppler	10-28

Transducer model: HFL38xp Operating mode: 2D + Color + PW Doppler	10-29
Transducer model: HFL50xp Operating mode: 2D	10-30
Transducer model: HFL50xp Operating mode: 2D + M Mode	10-31
Transducer model: HFL50xp Operating mode: Color/CPD	10-32
Transducer model: HFL50xp Operating mode: PW Doppler	10-33
Transducer model: HSL25xp Operating mode: 2D	10-34
Transducer model: HSL25xp Operating mode: 2D + M Mode	10-35
Transducer model: HSL25xp Operating mode: Color/CPD	10-36
Transducer model: HSL25xp Operating mode: PW Doppler	10-37
Transducer model: HSL25xp Operating mode: 2D + PW Doppler	10-38
Transducer model: HSL25xp Operating mode: 2D + Color + PW Doppler	10-39
Transducer model: HSL25xp (Ophthalmic) Operating mode: 2D	10-40
Transducer model: HSL25xp (Ophthalmic) Operating mode: 2D + M Mode	10-41
Transducer model: HSL25xp (Ophthalmic) Operating mode: Color/CPD	10-42
Transducer model: HSL25xp (Ophthalmic) Operating mode: PW Doppler	10-43
Transducer model: L25xp Operating mode: 2D	10-44
Transducer model: L25xp Operating mode: 2D + M Mode	10-45
Transducer model: L25xp Operating mode: Color/CPD	10-46
Transducer model: L25xp Operating mode: PW Doppler	10-47
Transducer model: L25xp Operating mode: 2D + PW Doppler	10-48
Transducer model: L25xp Operating mode: 2D + Color + PW Doppler	10-49
Transducer model: L25xp (Ophthalmic) Operating mode: 2D	10-50
Transducer model: L25xp (Ophthalmic) Operating mode: 2D + M Mode	10-51
Transducer model: L25xp (Ophthalmic) Operating mode: Color/CPD	10-52
Transducer model: L25xp (Ophthalmic) Operating mode: PW Doppler	10-53
Transducer model: ICTxp Operating mode: 2D + M Mode	10-54
Transducer model: ICTxp Operating mode: PW Doppler	10-55
Transducer model: L38xp Operating mode: 2D	10-56
Transducer model: L38xp Operating mode: 2D + M Mode	10-57
Transducer model: L38xp Operating mode: Color/CPD	10-58
Transducer model: L38xp Operating mode: PW Doppler	10-59
Transducer model: L38xp Operating mode: 2D + PW Doppler	10-60
Transducer model: L38xp Operating mode: 2D + Color + PW Doppler	10-61
Transducer model: P10xp Operating mode: 2D	10-62
Transducer model: P10xp Operating mode: 2D + M Mode	10-63
Transducer model: P10xp Operating mode: Color/CPD	10-64
Transducer model: P10xp Operating mode: PW Doppler	10-65
Transducer model: P10xp Operating mode: CW Doppler	10-66
Transducer model: P21xp Operating mode: 2D	10-67
Transducer model: P21xp Operating mode: 2D + M Mode	10-68
Transducer model: P21xp Operating mode: Color/CPD	10-69
Transducer model: P21xp Operating mode: PW Doppler	10-70
Transducer model: P21xp Operating mode: CW Doppler	10-71
Transducer model: P21xp (Orbital) Operating mode: 2D	10-72
Transducer model: P21xp (Orbital) Operating mode: 2D + M Mode	10-73
Transducer model: P21xp (Orbital) Operating mode: Color/CPD	10-74
Transducer model: P21xp (Orbital) Operating mode: PW Doppler	10-75

Transducer model: rP19xp Operating mode: 2D	10-76
Transducer model: rP19xp Operating mode: 2D + M Mode	10-77
Transducer model: rP19xp Operating mode: Color/CPD	10-78
Transducer model: rP19xp Operating mode: PW Doppler	10-79
Transducer model: rP19xp Operating mode: CW Doppler	10-80
Transducer model: rP19xp (Orbital) Operating mode: 2D	10-81
Transducer model: rP19xp (Orbital) Operating mode: 2D + M Mode	10-82
Transducer model: rP19xp (Orbital) Operating mode: Color/CPD	10-83
Transducer model: rP19xp (Orbital) Operating mode: PW Doppler	10-84
Transducer model: TEEp Operating mode: 2D	10-85
Transducer model: TEEp Operating mode: 2D + M Mode	10-86
Transducer model: TEEp Operating mode: CW Doppler	10-88
Transducer model: TEEp Operating mode: CW Doppler	10-88
Acoustic Measurement Precision and Uncertainty	10-89
Terms used in the acoustic output tables	10-90

Table 10-6: Transducer model: D2xp Operating mode: CW Doppler

Index label		MI	TIS		TIB		TIC
			At surface	Below surface	At surface	Below surface	At surface
Maximum index value		(a)	(a)		3.2		(b)
Index component value			#	#	0.9	3.2	
Acoustic parameters	$p_{r,\alpha}$ at z_{MI} (MPa)	#					
	P (mW)		#		90.4		#
	P_{1x1} (mW)		#		90.4		
	z_s (cm)			#			
	z_b (cm)					2.40	
	z_{MI} (cm)	#					
	$z_{pii,\alpha}$ (cm)	#					
	f_{awf} (MHz)	#	#		2.00		#
Other information	pr (Hz)	#					
	srr (Hz)	#					
	η_{pps}	#					
	$I_{pa,\alpha}$ at $z_{pii,\alpha}$ (W/cm^2)	#					
	$I_{spta,\alpha}$ at $z_{pii,\alpha}$ or $z_{sii,\alpha}$ (mW/cm^2)	#					
	I_{spta} at z_{pii} or z_{sii} (mW/cm^2)	#					
Operating controls	p_r at z_{pii} (MPa)	#					
	Exam type				Crd		
	Sample volume position				Fixed		

(a) This index is not required for this operating mode; value is <1.

(b) This transducer is not intended for transcranial or neonatal cephalic uses.

No data are reported for this operating condition since the global maximum index value is not reported for the reason listed. (Reference global maximum index value line.)

— Data are not applicable for this transducer/mode.

Table 10-7: Transducer model: C11xp Operating mode: 2D + M Mode

Index label		MI	TIS		TIB		TIC
			At surface	Below surface	At surface	Below surface	At surface
Maximum index value		1.0	(a)		(a)		(b)
Index component value			#	#	#	#	
Acoustic parameters	$p_{r,\alpha}$ at z_{MI} (MPa)	2.20					
	P (mW)		#		#		#
	$P_{1 \times 1}$ (mW)		#		#		
	z_s (cm)			#			
	z_b (cm)					#	
	z_{MI} (cm)	1.85					
	$z_{pii,\alpha}$ (cm)	1.85					
	f_{awf} (MHz)	5.03	#		#		#
Other information	p_{rr} (Hz)	400					
	s_{rr} (Hz)	50					
	η_{pps}	1					
	$I_{pa,\alpha}$ at $z_{pii,\alpha}$ (W/cm^2)	305					
	$I_{spta,\alpha}$ at $z_{pii,\alpha}$ or $z_{sii,\alpha}$ (mW/cm^2)	35.1					
	I_{spta} at z_{pii} or z_{sii} (mW/cm^2)	67.7					
	p_r at z_{pii} (MPa)	3.04					
Operating controls	Exam type	Ven					
	Optimization	Gen					
	Depth (cm)	4.0					

(a) This index is not required for this operating mode; value is <1.

(b) This transducer is not intended for transcranial or neonatal cephalic uses.

No data are reported for this operating condition since the global maximum index value is not reported for the reason listed. (Reference global maximum index value line.)

— Data are not applicable for this transducer/mode.

Table 10–8: Transducer model: C11xp Operating mode: PW Doppler

Index label		MI	TIS		TIB		TIC
			At surface	Below surface	At surface	Below surface	At surface
Maximum index value		1.0	(a)		1.2		(b)
Index component value			#	#	0.3	1.2	
Acoustic parameters	$p_{r,\alpha}$ at z_{MI} (MPa)	1.96					
	P (mW)		#		14.7		#
	$P_{1 \times 1}$ (mW)		#		14.7		
	z_s (cm)			#			
	z_b (cm)					1.30	
	z_{MI} (cm)	1.7					
	$z_{pii,\alpha}$ (cm)	1.7					
	f_{awf} (MHz)	4.07	#		4.02		#
Other information	pr (Hz)	1562					
	srr (Hz)	—					
	η_{pps}	1					
	$I_{pa,\alpha}$ at $z_{pii,\alpha}$ (W/cm^2)	184					
	$I_{spta,\alpha}$ at $z_{pii,\alpha}$ or $z_{sii,\alpha}$ (mW/cm^2)	326.8					
	I_{spta} at z_{pii} or z_{sii} (mW/cm^2)	583.4					
	p_r at z_{pii} (MPa)	2.49					
Operating controls	Exam type	Abd			Abd		
	Sample volume size (mm)	1			2		
	Sample volume position	Zone 3 (22 mm)			Zone 2 (15 mm)		
	PRF (Hz)	1563			1562		

(a) This index is not required for this operating mode; value is <1.

(b) This transducer is not intended for transcranial or neonatal cephalic uses.

No data are reported for this operating condition since the global maximum index value is not reported for the reason listed. (Reference global maximum index value line.)

— Data are not applicable for this transducer/mode.

Table 10-9: Transducer model: C35xp Operating mode: 2D

Index label		MI	TIS		TIB		TIC
			At surface	Below surface	At surface	Below surface	At surface
Maximum index value		1.3	(a)		(a)		(b)
Index component value			#	#	#	#	
Acoustic parameters	$p_{r,\alpha}$ at z_{MI} (MPa)	2.38					
	P (mW)		#		#		#
	P_{1x1} (mW)		#		#		
	z_s (cm)			—			
	z_b (cm)					—	
	z_{MI} (cm)	2.6					
	$z_{pii,\alpha}$ (cm)	2.6					
f_{awf} (MHz)	3.42		#		#		#
Other information	pr_r (Hz)	506					
	srr (Hz)	7.8					
	η_{pps}	1					
	$I_{pa,\alpha}$ at $z_{pii,\alpha}$ (W/cm^2)	557					
	$I_{spta,\alpha}$ at $z_{pii,\alpha}$ or $z_{sii,\alpha}$ (mW/cm^2)	5.8					
	I_{spta} at z_{pii} or z_{sii} (mW/cm^2)	10.8					
p_r at z_{pii} (MPa)	3.23						
Operating controls	Exam type	Msk					
	Optimization	Res					
	Depth (cm)	6.0					
	MB/THI	On/on					
	Needle profiling	On					

(a) This index is not required for this operating mode; value is <1.

(b) This transducer is not intended for transcranial or neonatal cephalic uses.

No data are reported for this operating condition since the global maximum index value is not reported for the reason listed. (Reference global maximum index value line.)

— Data are not applicable for this transducer/mode.

Table 10-10: Transducer model: C35xp Operating mode: 2D + M Mode

Index label		MI	TIS		TIB		TIC
			At surface	Below surface	At surface	Below surface	At surface
Maximum index value		1.3	(a)		1.0		(b)
Index component value			#	#	0.6	1.0	
Acoustic parameters	$p_{r,\alpha}$ at z_{MI} (MPa)	2.74					
	P (mW)		#		90.9		#
	P_{1x1} (mW)		#		30.7		
	z_s (cm)			#			
	z_b (cm)					1.40	
	z_{MI} (cm)	3.0					
	$z_{pii,\alpha}$ (cm)	3.0					
	f_{awf} (MHz)	4.43	#		4.44		#
Other information	pr (Hz)	400					
	srr (Hz)	21.1					
	η_{pps}	1					
	$I_{pa,\alpha}$ at $z_{pii,\alpha}$ (W/cm^2)	460					
	$I_{spta,\alpha}$ at $z_{pii,\alpha}$ or $z_{sii,\alpha}$ (mW/cm^2)	64.6					
	I_{spta} at z_{pii} or z_{sii} (mW/cm^2)	164.4					
	p_r at z_{pii} (MPa)	4.30					
Operating controls	Exam type	Abd			Abd		
	Optimization	Gen			Gen		
	Depth (cm)	6.0			3.0		
	THI	Off			Off		

(a) This index is not required for this operating mode; value is <1.

(b) This transducer is not intended for transcranial or neonatal cephalic uses.

No data are reported for this operating condition since the global maximum index value is not reported for the reason listed. (Reference global maximum index value line.)

— Data are not applicable for this transducer/mode.

Table 10-11: Transducer model: C35xp Operating mode: PW Doppler

Index label		MI	TIS		TIB		TIC
			At surface	Below surface	At surface	Below surface	At surface
Maximum index value		1.0	(a)		1.9		(b)
Index component value			#	#	0.8	1.9	
Acoustic parameters	$p_{r,\alpha}$ at z_{MI} (MPa)	1.91					
	P (mW)		#		52.7		#
	$P_{1 \times 1}$ (mW)		#		44.8		
	z_s (cm)			#			
	z_b (cm)					4.00	
	z_{MI} (cm)	0.4					
	$z_{pii,\alpha}$ (cm)	0.4					
	f_{awf} (MHz)	3.71		#	3.69		#
Other information	prf (Hz)	1562					
	srr (Hz)	—					
	η_{pps}	1					
	$I_{pa,\alpha}$ at $z_{pii,\alpha}$ (W/cm ²)	141					
	$I_{spta,\alpha}$ at $z_{pii,\alpha}$ or $z_{sij,\alpha}$ (mW/cm ²)	266.3					
	I_{spta} at z_{pii} or z_{sij} (mW/cm ²)	299.3					
	p_r at z_{pii} (MPa)	2.01					
Operating controls	Exam type	Abd			Abd		
	Sample volume size (mm)	1			1		
	Sample volume position	Zone 0 (5 mm)			Zone 6 (53 mm)		
	PRF (Hz)	1562			1562		

(a) This index is not required for this operating mode; value is <1.

(b) This transducer is not intended for transcranial or neonatal cephalic uses.

No data are reported for this operating condition since the global maximum index value is not reported for the reason listed. (Reference global maximum index value line.)

— Data are not applicable for this transducer/mode.

Table 10-12: Transducer model: C60xp Operating mode: 2D

Index label		MI	TIS		TIB		TIC
			At surface	Below surface	At surface	Below surface	At surface
Maximum index value		1.4	(a)		(a)		(b)
Index component value			#	#	#	#	
Acoustic parameters	$p_{r,\alpha}$ at z_{MI} (MPa)	2.17					
	P (mW)		#		#		#
	$P_{1 \times 1}$ (mW)		#		#		
	z_s (cm)			—			
	z_b (cm)					—	
	z_{MI} (cm)	4.3					
	$z_{pii,\alpha}$ (cm)	4.3					
	f_{awf} (MHz)	2.37		#		#	
Other information	p_{rr} (Hz)	839					
	s_{rr} (Hz)	12.9					
	n_{pps}	1					
	$I_{pa,\alpha}$ at $z_{pii,\alpha}$ (W/cm ²)	516					
	$I_{spta,\alpha}$ at $z_{pii,\alpha}$ or $z_{sii,\alpha}$ (mW/cm ²)	7.7					
	I_{spta} at z_{pii} or z_{sii} (mW/cm ²)	15.5					
	p_r at z_{pii} (MPa)	3.09					
Operating controls	Exam type	Msk					
	Optimization	Gen					
	Depth (cm)	9.9					
	MB/THI	On/off					
	Needle profiling	On					

(a) This index is not required for this operating mode; value is <1.

(b) This transducer is not intended for transcranial or neonatal cephalic uses.

No data are reported for this operating condition since the global maximum index value is not reported for the reason listed. (Reference global maximum index value line.)

— Data are not applicable for this transducer/mode.

Table 10-13: Transducer model: C60xp Operating mode: 2D + M Mode

Index label		MI	TIS		TIB		TIC
			At surface	Below surface	At surface	Below surface	At surface
Maximum index value		1.4	(a)		(a)		(b)
Index component value			#	#	#	#	
Acoustic parameters	$p_{r,\alpha}$ at z_{MI} (MPa)	2.26					
	P (mW)		#		#		#
	$P_{1 \times 1}$ (mW)		#		#		
	z_s (cm)			#			
	z_b (cm)					#	
	z_{MI} (cm)	4.3					
	$z_{pii,\alpha}$ (cm)	4.3					
	f_{awf} (MHz)	2.73	#		#		#
Other information	pr (Hz)	400					
	srr (Hz)	22.2					
	η_{pps}	1					
	$I_{pa,\alpha}$ at $z_{pii,\alpha}$ (W/cm^2)	346					
	$I_{spta,\alpha}$ at $z_{pii,\alpha}$ or $z_{sii,\alpha}$ (mW/cm^2)	72.6					
	I_{spta} at z_{pii} or z_{sii} (mW/cm^2)	165.5					
	p_r at z_{pii} (MPa)	3.41					
Operating controls	Exam type	Nrv					
	Optimization	Pen					
	Depth (cm)	9.9					
	MB/THI	Off/off					

(a) This index is not required for this operating mode; value is <1.

(b) This transducer is not intended for transcranial or neonatal cephalic uses.

No data are reported for this operating condition since the global maximum index value is not reported for the reason listed. (Reference global maximum index value line.)

— Data are not applicable for this transducer/mode.

Table 10-14: Transducer model: C60xp Operating mode: Color/CPD

Index label		MI	TIS		TIB		TIC
			At surface	Below surface	At surface	Below surface	At surface
Maximum index value		1.2	1.0		1.0		(b)
Index component value			1.0	1.0	1.0	1.0	
Acoustic parameters	$p_{r,\alpha}$ at z_{MI} (MPa)	1.99					
	P (mW)		98.5		98.5		#
	$P_{1 \times 1}$ (mW)		81.3		81.3		
	z_s (cm)			—			
	z_b (cm)					—	
	z_{MI} (cm)	4.4					
	$z_{pii,\alpha}$ (cm)	4.4					
	f_{awf} (MHz)	2.63	2.63		2.63		#
Other information	pr_r (Hz)	2654					
	srr (Hz)	2.9					
	n_{pps}	10					
	$I_{pa,\alpha}$ at $z_{pii,\alpha}$ (W/cm^2)	346					
	$I_{spta,\alpha}$ at $z_{pii,\alpha}$ or $z_{sij,\alpha}$ (mW/cm^2)	27.1					
	I_{spta} at z_{pii} or z_{sij} (mW/cm^2)	59.7					
	p_r at z_{pii} (MPa)	2.96					
Operating controls	Exam type	Abd	Ob		Ob		
	Mode	Color	Color		Color		
	2D optimization/THI/depth (cm)	Gen/on/11	Gen/off/6.0		Gen/off/6.0		
	Color optimization/PRF (Hz)	High/3049	Low/414		Low/414		
	Color box position/size	Default/wide and tall	Default/narrow		Default/narrow		

(a) This index is not required for this operating mode; value is <1.

(b) This transducer is not intended for transcranial or neonatal cephalic uses.

No data are reported for this operating condition since the global maximum index value is not reported for the reason listed. (Reference global maximum index value line.)

— Data are not applicable for this transducer/mode.

Table 10-15: Transducer model: C60xp Operating mode: PW Doppler

Index label		MI	TIS		TIB		TIC
			At surface	Below surface	At surface	Below surface	At surface
Maximum index value		1.5	1.0		2.9		(b)
Index component value			0.5	1.0	1.0	2.9	
Acoustic parameters	$p_{r,\alpha}$ at z_{MI} (MPa)	2.44					
	P (mW)		154.7		77.0		#
	P_{1x1} (mW)		38.2		77.0		
	z_s (cm)			3.7			
	z_b (cm)					1.89	
	z_{MI} (cm)	1.9					
	$z_{pii,\alpha}$ (cm)	1.9					
f_{awf} (MHz)	2.64		2.66		2.66		#
Other information	pr (Hz)	1302					
	srr (Hz)	—					
	η_{pps}	1					
	$I_{pa,\alpha}$ at $z_{pii,\alpha}$ (W/cm^2)	239					
	$I_{spta,\alpha}$ at $z_{pii,\alpha}$ or $z_{sii,\alpha}$ (mW/cm^2)	384.6					
	I_{spta} at z_{pii} or z_{sii} (mW/cm^2)	639.4					
p_r at z_{pii} (MPa)	2.89						
Operating controls	Exam type	Ob	Ob		Ob		
	Sample volume size (mm)	1	3		3		
	Sample volume position	Zone 2	Zone 8		Zone 2		
	PRF (Hz)	1302	1302		3906		

(a) This index is not required for this operating mode; value is <1.

(b) This transducer is not intended for transcranial or neonatal cephalic uses.

No data are reported for this operating condition since the global maximum index value is not reported for the reason listed. (Reference global maximum index value line.)

— Data are not applicable for this transducer/mode.

Table 10-16: Transducer model: HFL38xp Operating mode: 2D

Index label		MI	TIS		TIB		TIC
			At surface	Below surface	At surface	Below surface	At surface
Maximum index value		1.1	(a)		(a)		(b)
Index component value			#	#	#	#	
Acoustic parameters	$p_{r,\alpha}$ at z_{MI} (MPa)	2.49					
	P (mW)		#		#		#
	$P_{1 \times 1}$ (mW)		#		#		
	z_s (cm)			—			
	z_b (cm)					—	
	z_{MI} (cm)	1.2					
	$z_{pii,\alpha}$ (cm)	1.2					
	f_{awf} (MHz)	5.34	#		#		#
Other information	pr (Hz)	1336					
	srr (Hz)	13.8					
	n_{pps}	1					
	$I_{pa,\alpha}$ at $z_{pii,\alpha}$ (W/cm^2)	415					
	$I_{spta,\alpha}$ at $z_{pii,\alpha}$ or $z_{sii,\alpha}$ (mW/cm^2)	71					
	I_{spta} at z_{pii} or z_{sii} (mW/cm^2)	11.1					
	p_r at z_{pii} (MPa)	3.11					
Operating controls	Exam type	Ven					
	Optimization	Res					
	Depth (cm)	3.5					
	Needle profiling	On					

(a) This index is not required for this operating mode; value is <1.

(b) This transducer is not intended for transcranial or neonatal cephalic uses.

No data are reported for this operating condition since the global maximum index value is not reported for the reason listed. (Reference global maximum index value line.)

— Data are not applicable for this transducer/mode.

Table 10-17: Transducer model: HFL38xp Operating mode: 2D + M Mode

Index label		MI	TIS		TIB		TIC
			At surface	Below surface	At surface	Below surface	At surface
Maximum index value		1.0	(a)		(a)		(b)
Index component value			#	#	#	#	
Acoustic parameters	$p_{r,\alpha}$ at z_{MI} (MPa)	2.72					
	P (mW)		#		#		—
	$P_{1 \times 1}$ (mW)		#		#		
	z_s (cm)			#			
	z_b (cm)					—	
	z_{MI} (cm)	1.15					
	$z_{pii,\alpha}$ (cm)	1.15					
	f_{awf} (MHz)	7.82	#		—		—
Other information	pr (Hz)	400					
	srr (Hz)	44.4					
	η_{pps}	400					
	$I_{pa,\alpha}$ at $z_{pii,\alpha}$ (W/cm^2)	318					
	$I_{spta,\alpha}$ at $z_{pii,\alpha}$ or $z_{sii,\alpha}$ (mW/cm^2)	26.3					
	I_{spta} at z_{pii} or z_{sii} (mW/cm^2)	51.4					
	p_r at z_{pii} (MPa)	3.72					
Operating controls	Exam type	Bre					
	Optimization	Gen					
	Depth (cm)	1.9					
	MB	Off					

(a) This index is not required for this operating mode; value is <1.

(b) This transducer is not intended for transcranial or neonatal cephalic uses.

No data are reported for this operating condition since the global maximum index value is not reported for the reason listed. (Reference global maximum index value line.)

— Data are not applicable for this transducer/mode.

Table 10-18: Transducer model: HFL38xp Operating mode: Color/CPD

Index label		MI	TIS		TIB		TIC
			At surface	Below surface	At surface	Below surface	At surface
Maximum index value		1.0	(a)		(a)		(b)
Index component value			#	#	#	#	
Acoustic parameters	$p_{r,\alpha}$ at z_{MI} (MPa)	2.54					
	P (mW)		#		#		#
	$P_{1 \times 1}$ (mW)		#		#		
	z_s (cm)			—			
	z_b (cm)					—	
	z_{MI} (cm)	1.2					
	$z_{pii,\alpha}$ (cm)	1.2					
f_{awf} (MHz)	5.93		#		#		#
Other information	pr_r (Hz)	6640					
	srr (Hz)	7.9					
	n_{pps}	14					
	$I_{pa,\alpha}$ at $z_{pii,\alpha}$ (W/cm^2)	375					
	$I_{spta,\alpha}$ at $z_{pii,\alpha}$ or $z_{sij,\alpha}$ (mW/cm^2)	43.9					
	I_{spta} at z_{pii} or z_{sij} (mW/cm^2)	69.8					
	p_r at z_{pii} (MPa)	3.25					
Operating controls	Exam type	Nerve					
	Mode	Color					
	2D optimization/depth (cm)	Res/4.0					
	Color optimization/PRF (Hz)	High/7812					
	Color box position/size	Default/wide					

(a) This index is not required for this operating mode; value is <1.

(b) This transducer is not intended for transcranial or neonatal cephalic uses.

No data are reported for this operating condition since the global maximum index value is not reported for the reason listed. (Reference global maximum index value line.)

— Data are not applicable for this transducer/mode.

Table 10-19: Transducer model: HFL38xp Operating mode: PW Doppler

Index label		MI	TIS		TIB		TIC
			At surface	Below surface	At surface	Below surface	At surface
Maximum index value		(a)	1.1		1.7		(b)
Index component value			1.1	0.7	0.8	1.7	
Acoustic parameters	$p_{r,\alpha}$ at z_{MI} (MPa)	#					
	P (mW)		36.8		29.2		#
	P_{1x1} (mW)		36.8		29.2		
	z_s (cm)			1.1			
	z_b (cm)					1.00	
	z_{MI} (cm)	#					
	$z_{pii,\alpha}$ (cm)	#					
	f_{awf} (MHz)	#	6.00		5.98		#
Other information	pr (Hz)	#					
	srr (Hz)	#					
	η_{pps}	#					
	$I_{pa,\alpha}$ at $z_{pii,\alpha}$ (W/cm^2)	#					
	$I_{spta,\alpha}$ at $z_{pii,\alpha}$ or $z_{sii,\alpha}$ (mW/cm^2)	#					
	I_{spta} at z_{pii} or z_{sii} (mW/cm^2)	#					
	p_r at z_{pii} (MPa)	#					
Operating controls	Exam type		Non-art		Non-art		
	Sample volume size (mm)		2		1		
	Sample volume position		Zone 11		Zone 8		
	PRF (Hz)		1562		2604		

(a) This index is not required for this operating mode; value is <1.

(b) This transducer is not intended for transcranial or neonatal cephalic uses.

No data are reported for this operating condition since the global maximum index value is not reported for the reason listed. (Reference global maximum index value line.)

— Data are not applicable for this transducer/mode.

Table 10–20: Transducer model: HFL38xp Operating mode: 2D + PW Doppler

Index label		MI	TIS		TIB		TIC
			At surface	Below surface	At surface	Below surface	At surface
Maximum index value		1.5	1.0		1.5		(b)
Index component value			1.0	0.7	0.9	1.5	
Acoustic parameters	$p_{r,\alpha}$ at z_{MI} (MPa)	#					
	P (mW)		39.4		36.0		#
	$P_{1 \times 1}$ (mW)		34.7		31.6		
	z_s (cm)			1.1			
	z_b (cm)					1.63	
	z_{MI} (cm)	#					
	$z_{pii,\alpha}$ (cm)	#					
	f_{awf} (MHz)	#	5.97		5.97		#
Other information	pr (Hz)	#					
	srr (Hz)	#					
	n_{pps}	#					
	$I_{pa,\alpha}$ at $z_{pii,\alpha}$ (W/cm^2)	#					
	$I_{spta,\alpha}$ at $z_{pii,\alpha}$ or $z_{sii,\alpha}$ (mW/cm^2)	#					
	I_{spta} at z_{pii} or z_{sii} (mW/cm^2)	#					
	p_r at z_{pii} (MPa)	#					
Operating controls	Exam type		Venous		Venous		
	2D optimization		Gen		Gen		
	Depth (cm)		5.6		4.4		
	Sample volume size (mm)		1		1		
	Sample volume position		Zone 11		Zone 9		
	PRF (Hz)		10417		5208		

(a) This index is not required for this operating mode; value is <1.

(b) This transducer is not intended for transcranial or neonatal cephalic uses.

No data are reported for this operating condition since the global maximum index value is not reported for the reason listed. (Reference global maximum index value line.)

— Data are not applicable for this transducer/mode.

Table 10-21: Transducer model: HFL38xp Operating mode: 2D + Color + PW Doppler

Index label		MI	TIS		TIB		TIC
			At surface	Below surface	At surface	Below surface	At surface
Maximum index value		1.1	1.0		1.4		(b)
Index component value			1.0	0.7	0.5	1.4	
Acoustic parameters	$p_{r,\alpha}$ at z_{MI} (MPa)	2.61					
	P (mW)		38.8		35.5		#
	$P_{1 \times 1}$ (mW)		34.5		19.5		
	z_s (cm)			1.2			
	z_b (cm)					1.45	
	z_{MI} (cm)	1.1					
	$z_{pii,\alpha}$ (cm)	1.1					
	f_{awf} (MHz)	5.90	5.97		4.86		#
Other information	prr (Hz)	4343					
	srr (Hz)	7.2					
	n_{pps}	14					
	$I_{pa,\alpha}$ at $z_{pii,\alpha}$ (W/cm^2)	401					
	$I_{spta,\alpha}$ at $z_{pii,\alpha}$ or $z_{sii,\alpha}$ (mW/cm^2)	56.4					
	I_{spta} at z_{pii} or z_{sii} (mW/cm^2)	89.0					
	p_r at z_{pii} (MPa)	3.25					
Operating controls	Exam type	Arterial	Venous		Arterial		
	2D optimization	Res	Gen		Res		
	Depth (cm)	5.6 (index 1)	5.6		4.4 (index 7)		
	Color box position/size	Default/default	Default/narrow		Default/wide		
	Sample volume size (mm)	1	1		1		
	Sample volume position	Zone 2	Zone 11		Zone 06		
	PW PRF (Hz)	5208	10417		15625		

(a) This index is not required for this operating mode; value is <1.

(b) This transducer is not intended for transcranial or neonatal cephalic uses.

No data are reported for this operating condition since the global maximum index value is not reported for the reason listed. (Reference global maximum index value line.)

— Data are not applicable for this transducer/mode.

Table 10-22: Transducer model: HFL50xp Operating mode: 2D

Index label		MI	TIS		TIB		TIC
			At surface	Below surface	At surface	Below surface	At surface
Maximum index value		1.1	(a)		(a)		(b)
Index component value			#	#	#	#	
Acoustic parameters	$p_{r,\alpha}$ at z_{MI} (MPa)	2.61					
	P (mW)		#		#		#
	P_{1x1} (mW)		#		#		
	z_s (cm)			—			
	z_b (cm)					—	
	z_{MI} (cm)	1.3					
	$z_{pii,\alpha}$ (cm)	1.3					
	f_{awf} (MHz)	5.30	#		#		#
Other information	pr (Hz)	1084					
	srr (Hz)	8.4					
	η_{pps}	1					
	$I_{pa,\alpha}$ at $z_{pii,\alpha}$ (W/cm^2)	427					
	$I_{spta,\alpha}$ at $z_{pii,\alpha}$ or $z_{sii,\alpha}$ (mW/cm^2)	5.5					
	I_{spta} at z_{pii} or z_{sii} (mW/cm^2)	8.7					
	p_r at z_{pii} (MPa)	3.31					
Operating controls	Exam type	SmP					
	Optimization	Res					
	Depth (cm)	4.8					
	MB	On/off					
	Needle profiling	On					

(a) This index is not required for this operating mode; value is <1.

(b) This transducer is not intended for transcranial or neonatal cephalic uses.

No data are reported for this operating condition since the global maximum index value is not reported for the reason listed. (Reference global maximum index value line.)

— Data are not applicable for this transducer/mode.

Table 10-23: Transducer model: HFL50xp Operating mode: 2D + M Mode

Index label		MI	TIS		TIB		TIC
			At surface	Below surface	At surface	Below surface	At surface
Maximum index value		1.0	(a)		(a)		(b)
Index component value			#	#	#	#	
Acoustic parameters	$p_{r,\alpha}$ at z_{MI} (MPa)	2.72					
	P (mW)		#		#		—
	$P_{1 \times 1}$ (mW)		#		#		
	z_s (cm)			#			
	z_b (cm)					—	
	z_{MI} (cm)	1.15					
	$z_{pii,\alpha}$ (cm)	1.15					
f_{awf} (MHz)	7.82		#		—	—	
Other information	pr (Hz)	400					
	srr (Hz)	36.4					
	η_{pps}	1					
	$I_{pa,\alpha}$ at $z_{pii,\alpha}$ (W/cm^2)	318					
	$I_{spta,\alpha}$ at $z_{pii,\alpha}$ or $z_{sii,\alpha}$ (mW/cm^2)	26.3					
	I_{spta} at z_{pii} or z_{sii} (mW/cm^2)	51.3					
p_r at z_{pii} (MPa)	3.72						
Operating controls	Exam type	Bre					
	Optimization	Gen					
	Depth (cm)	1.9					
	MB	Off					

(a) This index is not required for this operating mode; value is <1.

(b) This transducer is not intended for transcranial or neonatal cephalic uses.

No data are reported for this operating condition since the global maximum index value is not reported for the reason listed. (Reference global maximum index value line.)

— Data are not applicable for this transducer/mode.

Table 10-24: Transducer model: HFL50xp Operating mode: Color/CPD

Index label		MI	TIS		TIB		TIC
			At surface	Below surface	At surface	Below surface	At surface
Maximum index value		1.1	(a)		(a)		(b)
Index component value			#	#	#	#	
Acoustic parameters	$p_{r,\alpha}$ at z_{MI} (MPa)	2.62					
	P (mW)		#		#		#
	$P_{1 \times 1}$ (mW)		#		#		
	z_s (cm)			—			
	z_b (cm)					—	
	z_{MI} (cm)	1.2					
	$z_{pii,\alpha}$ (cm)	1.2					
	f_{awf} (MHz)	5.93	#		#		#
Other information	pr_r (Hz)	6649					
	srr (Hz)	5.9					
	n_{pps}	14					
	$I_{pa,\alpha}$ at $z_{pii,\alpha}$ (W/cm^2)	398					
	$I_{spta,\alpha}$ at $z_{pii,\alpha}$ or $z_{sij,\alpha}$ (mW/cm^2)	35.4					
	I_{spta} at z_{pii} or z_{sij} (mW/cm^2)	56.1					
	p_r at z_{pii} (MPa)	3.35					
Operating controls	Exam type	SmP					
	Mode	CVD					
	2D optimization/depth (cm)	Res/4.0					
	Color optimization/PRF (Hz)	High/7812					
	Color box position/size	Default/wide and tall					

(a) This index is not required for this operating mode; value is <1.

(b) This transducer is not intended for transcranial or neonatal cephalic uses.

No data are reported for this operating condition since the global maximum index value is not reported for the reason listed. (Reference global maximum index value line.)

— Data are not applicable for this transducer/mode.

Table 10-25: Transducer model: HFL50xp Operating mode: PW Doppler

Index label		MI	TIS		TIB		TIC
			At surface	Below surface	At surface	Below surface	At surface
Maximum index value		(a)	1.1		1.7		(b)
Index component value			1.1	0.7	0.8	1.7	
Acoustic parameters	$p_{r,\alpha}$ at z_{MI} (MPa)	#					
	P (mW)		38.3		29.2		#
	P_{1x1} (mW)		38.3		29.2		
	z_s (cm)			1.1			
	z_b (cm)					1.00	
	z_{MI} (cm)	#					
	$z_{pii,\alpha}$ (cm)	#					
	f_{awf} (MHz)	#	6.00		5.98		#
Other information	pr (Hz)	#					
	srr (Hz)	#					
	η_{pps}	#					
	$I_{pa,\alpha}$ at $z_{pii,\alpha}$ (W/cm^2)	#					
	$I_{spta,\alpha}$ at $z_{pii,\alpha}$ or $z_{sii,\alpha}$ (mW/cm^2)	#					
	I_{spta} at z_{pii} or z_{sii} (mW/cm^2)	#					
	p_r at z_{pii} (MPa)	#					
Operating controls	Exam type		Any		Any		
	Sample volume size (mm)		3		1		
	Sample volume position		Zone 11		Zone 8		
	PRF (Hz)		1562		2604		

(a) This index is not required for this operating mode; value is <1.

(b) This transducer is not intended for transcranial or neonatal cephalic uses.

No data are reported for this operating condition since the global maximum index value is not reported for the reason listed. (Reference global maximum index value line.)

— Data are not applicable for this transducer/mode.

Table 10-26: Transducer model: HSL25xp Operating mode: 2D

Index label		MI	TIS		TIB		TIC
			At surface	Below surface	At surface	Below surface	At surface
Maximum index value		1.0	(a)		(a)		(b)
Index component value			#	#	#	#	
Acoustic parameters	$p_{r,\alpha}$ at z_{MI} (MPa)	2.42					
	P (mW)		#		#		#
	P_{1x1} (mW)		#		#		
	z_s (cm)			—			
	z_b (cm)					—	
	z_{MI} (cm)	0.9					
	$z_{pii,\alpha}$ (cm)	0.9					
	f_{awf} (MHz)	6.08	#		#		#
Other information	pr (Hz)	783					
	srr (Hz)	12.1					
	η_{pps}	1					
	$I_{pa,\alpha}$ at $z_{pii,\alpha}$ (W/cm^2)	328					
	$I_{spta,\alpha}$ at $z_{pii,\alpha}$ or $z_{sii,\alpha}$ (mW/cm^2)	4.9					
	I_{spta} at z_{pii} or z_{sii} (mW/cm^2)	7.3					
	p_r at z_{pii} (MPa)	2.92					
Operating controls	Exam type	Ven					
	Optimization	Res					
	Depth (cm)	2.4					
	MB	On					
	Needle profiling	On					

(a) This index is not required for this operating mode; value is <1.

(b) This transducer is not intended for transcranial or neonatal cephalic uses.

No data are reported for this operating condition since the global maximum index value is not reported for the reason listed. (Reference global maximum index value line.)

— Data are not applicable for this transducer/mode.

Table 10-27: Transducer model: HSL25xp Operating mode: 2D + M Mode

Index label		MI	TIS		TIB		TIC
			At surface	Below surface	At surface	Below surface	At surface
Maximum index value		1.1	(a)		(a)		(b)
Index component value			#	#	#	#	
Acoustic parameters	$p_{r,\alpha}$ at z_{MI} (MPa)	3.05					
	P (mW)		#		#		#
	$P_{1 \times 1}$ (mW)		#		#		
	z_s (cm)			#			
	z_b (cm)					#	
	z_{MI} (cm)	1.0					
	$z_{pii,\alpha}$ (cm)	1.0					
f_{awf} (MHz)	7.08		#		#		#
Other information	pr (Hz)	400					
	srr (Hz)	40					
	η_{pps}	1					
	$I_{pa,\alpha}$ at $z_{pii,\alpha}$ (W/cm^2)	362					
	$I_{spta,\alpha}$ at $z_{pii,\alpha}$ or $z_{sii,\alpha}$ (mW/cm^2)	26.2					
	I_{spta} at z_{pii} or z_{sii} (mW/cm^2)	41.9					
p_r at z_{pii} (MPa)	3.88						
Operating controls	Exam type	Lung					
	Optimization	Res					
	Depth (cm)	2.0					
	MB	Off					

(a) This index is not required for this operating mode; value is <1.

(b) This transducer is not intended for transcranial or neonatal cephalic uses.

No data are reported for this operating condition since the global maximum index value is not reported for the reason listed. (Reference global maximum index value line.)

— Data are not applicable for this transducer/mode.

Table 10–28: Transducer model: HSL25xp Operating mode: Color/CPD

Index label		MI	TIS		TIB		TIC
			At surface	Below surface	At surface	Below surface	At surface
Maximum index value		1.1	(a)		(a)		(b)
Index component value			#	#	#	#	
Acoustic parameters	$p_{r,\alpha}$ at z_{MI} (MPa)	2.81					
	P (mW)		#		#		#
	$P_{1 \times 1}$ (mW)		#		#		
	z_s (cm)			—			
	z_b (cm)					—	
	z_{MI} (cm)	1.0					
	$z_{pii,\alpha}$ (cm)	1.0					
	f_{awf} (MHz)	7.08	#		#		#
Other information	pr_r (Hz)	1717					
	srr (Hz)	13.3					
	n_{pps}	1					
	$I_{pa,\alpha}$ at $z_{pii,\alpha}$ (W/cm^2)	321					
	$I_{spta,\alpha}$ at $z_{pii,\alpha}$ or $z_{sij,\alpha}$ (mW/cm^2)	2.8					
	I_{spta} at z_{pii} or z_{sij} (mW/cm^2)	4.4					
	p_r at z_{pii} (MPa)	3.6					
Operating controls	Exam type	Msk					
	Mode	CPD					
	2D optimization/depth (cm)	Res/2.0					
	Color optimization/PRF (Hz)	Low/312					
	Color box position/size	Default/narrow					

(a) This index is not required for this operating mode; value is <1.

(b) This transducer is not intended for transcranial or neonatal cephalic uses.

No data are reported for this operating condition since the global maximum index value is not reported for the reason listed. (Reference global maximum index value line.)

— Data are not applicable for this transducer/mode.

Table 10-29: Transducer model: HSL25xp Operating mode: PW Doppler

Index label		MI	TIS		TIB		TIC
			At surface	Below surface	At surface	Below surface	At surface
Maximum index value		(a)	(a)		1.1		(b)
Index component value			#	#	0.4	1.1	
Acoustic parameters	$p_{r,\alpha}$ at z_{MI} (MPa)	#					
	P (mW)		#		14.7		#
	P_{1x1} (mW)		#		14.7		
	z_s (cm)			#			
	z_b (cm)					1.40	
	z_{MI} (cm)	#					
	$z_{pii,\alpha}$ (cm)	#					
f_{awf} (MHz)	#		#	6.01		#	
Other information	pr (Hz)	#					
	srr (Hz)	#					
	η_{pps}	#					
	$I_{pa,\alpha}$ at $z_{pii,\alpha}$ (W/cm^2)	#					
	$I_{spta,\alpha}$ at $z_{pii,\alpha}$ or $z_{sii,\alpha}$ (mW/cm^2)	#					
	I_{spta} at z_{pii} or z_{sii} (mW/cm^2)	#					
p_r at z_{pii} (MPa)	#						
Operating controls	Exam type				Ven		
	Sample volume size (mm)				3		
	Sample volume position				Zone 6 (24 mm)		
	PRF (Hz)				1562		

(a) This index is not required for this operating mode; value is <1.

(b) This transducer is not intended for transcranial or neonatal cephalic uses.

No data are reported for this operating condition since the global maximum index value is not reported for the reason listed. (Reference global maximum index value line.)

— Data are not applicable for this transducer/mode.

Table 10-30: Transducer model: HSL25xp Operating mode: 2D + PW Doppler

Index label		MI	TIS		TIB		TIC
			At surface	Below surface	At surface	Below surface	At surface
Maximum index value		1.1	(a)		(a)		(b)
Index component value			#	#	#	#	
Acoustic parameters	$p_{r,\alpha}$ at z_{MI} (MPa)	2.98					
	P (mW)		#		#		#
	P_{1x1} (mW)		#		#		
	z_s (cm)			#			
	z_b (cm)					#	
	z_{MI} (cm)	1.0					
	$z_{pii,\alpha}$ (cm)	1.0					
	f_{awf} (MHz)	6.81	#		#		#
Other information	pr (Hz)	7670					
	srr (Hz)	47.3					
	n_{pps}	1					
	$I_{pa,\alpha}$ at $z_{pii,\alpha}$ (W/cm^2)	374					
	$I_{spta,\alpha}$ at $z_{pii,\alpha}$ or $z_{sii,\alpha}$ (mW/cm^2)	12.3					
	I_{spta} at z_{pii} or z_{sii} (mW/cm^2)	18.8					
	p_r at z_{pii} (MPa)	3.77					
Operating controls	Exam type	Ven					
	2D optimization	Gen					
	Depth (cm)	2.0					
	Sample volume size (mm)	1					
	Sample volume position	Zone 0					
	PRF (Hz)	1562					

(a) This index is not required for this operating mode; value is <1.

(b) This transducer is not intended for transcranial or neonatal cephalic uses.

No data are reported for this operating condition since the global maximum index value is not reported for the reason listed. (Reference global maximum index value line.)

— Data are not applicable for this transducer/mode.

Table 10-31: Transducer model: HSL25xp Operating mode: 2D + Color + PW Doppler

Index label		MI	TIS		TIB		TIC
			At surface	Below surface	At surface	Below surface	At surface
Maximum index value		1.0	(a)		(a)		(b)
Index component value			#	#	#	#	
Acoustic parameters	$p_{r,\alpha}$ at z_{MI} (MPa)	2.62					
	P (mW)		#		#		#
	$P_{1 \times 1}$ (mW)		#		#		
	z_s (cm)			#			
	z_b (cm)					#	
	z_{MI} (cm)	1.1					
	$z_{pii,\alpha}$ (cm)	1.1					
f_{awf} (MHz)	7.15		#		#		#
Other information	prf (Hz)	1154					
	srr (Hz)	8.9					
	η_{pps}	1					
	$I_{pa,\alpha}$ at $z_{pii,\alpha}$ (W/cm ²)	267					
	$I_{spta,\alpha}$ at $z_{pii,\alpha}$ or $z_{sii,\alpha}$ (mW/cm ²)	2.0					
	I_{spta} at z_{pii} or z_{sii} (mW/cm ²)	3.1					
p_r at z_{pii} (MPa)	3.46						
Operating controls	Exam type	Ven					
	2D optimization	Res					
	Depth (cm)	3.1					
	Color box position/size	Default/wide					
	Sample volume size (mm)	1					
	Sample volume position	Zone 0					
PRF (Hz)	1562						

(a) This index is not required for this operating mode; value is <1.

(b) This transducer is not intended for transcranial or neonatal cephalic uses.

No data are reported for this operating condition since the global maximum index value is not reported for the reason listed. (Reference global maximum index value line.)

— Data are not applicable for this transducer/mode.

Table 10-32: Transducer model: HSL25xp (Ophthalmic) Operating mode: 2D

Index label		MI	TIS		TIB		TIC
			At surface	Below surface	At surface	Below surface	At surface
Maximum index value		0.17	0.03		0.03		(b)
Index component value			0.03	0.03	0.03	0.03	
Acoustic parameters	$p_{r,\alpha}$ at z_{MI} (MPa)	0.45					
	P (mW)		1.9		1.9		#
	P_{1x1} (mW)		0.8		0.8		
	z_s (cm)			—			
	z_b (cm)					—	
	z_{MI} (cm)	2.3					
	$z_{pii,\alpha}$ (cm)	2.3					
	f_{awf} (MHz)	6.85	7.15		7.15		#
Other information	pr (Hz)	10710					
	srr (Hz)	13.8					
	n_{pps}	6					
	$I_{pa,\alpha}$ at $z_{pii,\alpha}$ (W/cm^2)	11					
	$I_{spta,\alpha}$ at $z_{pii,\alpha}$ or $z_{sii,\alpha}$ (mW/cm^2)	2.4					
	I_{spta} at z_{pii} or z_{sii} (mW/cm^2)	4.0					
p_r at z_{pii} (MPa)	0.78						
Operating controls	Exam type	Oph	Oph		Oph		
	Optimization	Gen	Gen		Gen		
	Depth (cm)	4.9	6.0		6.0		
	MB	On	On		On		

(a) This index is not required for this operating mode; value is < 1.

(b) This transducer is not intended for transcranial or neonatal cephalic uses.

No data are reported for this operating condition since the global maximum index value is not reported for the reason listed. (Reference global maximum index value line.)

— Data are not applicable for this transducer/mode.

Table 10-33: Transducer model: HSL25xp (Ophthalmic) Operating mode: 2D + M Mode

Index label		MI	TIS		TIB		TIC
			At surface	Below surface	At surface	Below surface	At surface
Maximum index value		0.17	0.029		0.031		(b)
Index component value			0.029	0.028	0.029	0.031	
Acoustic parameters	$p_{r,\alpha}$ at z_{MI} (MPa)	0.46					
	P (mW)		1.72		1.72		#
	P_{1x1} (mW)		0.79		0.79		
	z_s (cm)			0.8			
	z_b (cm)					1.05	
	z_{MI} (cm)	1.25					
	$z_{pii,\alpha}$ (cm)	1.25					
	f_{awf} (MHz)	7.48	7.77		7.77		#
Other information	prf (Hz)	400					
	srr (Hz)	30.8					
	η_{pps}	1					
	$I_{pa,\alpha}$ at $z_{pii,\alpha}$ (W/cm^2)	15.5					
	$I_{spta,\alpha}$ at $z_{pii,\alpha}$ or $z_{sii,\alpha}$ (mW/cm^2)	1.0					
	I_{spta} at z_{pii} or z_{sii} (mW/cm^2)	1.9					
	p_r at z_{pii} (MPa)	0.63					
Operating controls	Exam type	Oph	Oph		Oph		
	Optimization	Gen	Res		Res		
	Depth (cm)	2.0	4.2		4.2		

(a) This index is not required for this operating mode; value is <1.

(b) This transducer is not intended for transcranial or neonatal cephalic uses.

No data are reported for this operating condition since the global maximum index value is not reported for the reason listed. (Reference global maximum index value line.)

— Data are not applicable for this transducer/mode.

Table 10-34: Transducer model: HSL25xp (Ophthalmic) Operating mode: Color/CPD

Index label		MI	TIS		TIB		TIC
			At surface	Below surface	At surface	Below surface	At surface
Maximum index value		0.17	0.08		0.08		(b)
Index component value			0.08	0.08	0.08	0.08	
Acoustic parameters	$p_{r,\alpha}$ at z_{MI} (MPa)	0.47					
	P (mW)		3.8		3.8		#
	$P_{1 \times 1}$ (mW)		2.6		2.6		
	z_s (cm)			—			
	z_b (cm)					—	
	z_{MI} (cm)	1.9					
	$z_{pii,\alpha}$ (cm)	1.9					
f_{awf} (MHz)	7.77	6.10		6.10		#	
Other information	pr_r (Hz)	2424					
	srr (Hz)	18.6					
	n_{pps}	1					
	$I_{pa,\alpha}$ at $z_{pii,\alpha}$ (W/cm^2)	17.7					
	$I_{spta,\alpha}$ at $z_{pii,\alpha}$ or $z_{sij,\alpha}$ (mW/cm^2)	0.4					
	I_{spta} at z_{pii} or z_{sij} (mW/cm^2)	0.8					
p_r at z_{pii} (MPa)	0.78						
Operating controls	Exam type	Oph	Oph		Oph		
	Mode	CPD	CPD		CPD		
	2D optimization/depth (cm)	Res/4.2	Res/4.9		Res/4.9		
	Color optimization/PRF (Hz)	Low/1250	Low/781		Low/781		
	Color box position/size	Top/wide and short	Bottom/default		Bottom/default		

(a) This index is not required for this operating mode; value is <1.
 (b) This transducer is not intended for transcranial or neonatal cephalic uses.
 # No data are reported for this operating condition since the global maximum index value is not reported for the reason listed. (Reference global maximum index value line.)
 — Data are not applicable for this transducer/mode.

Table 10-35: Transducer model: HSL25xp (Ophthalmic) Operating mode: PW Doppler

Index label		MI	TIS		TIB		TIC
			At surface	Below surface	At surface	Below surface	At surface
Maximum index value		0.17	0.19		0.26		(b)
Index component value			0.19	0.13	0.19	0.26	
Acoustic parameters	$p_{r,\alpha}$ at z_{MI} (MPa)	0.42					
	P (mW)		6.8		6.8		#
	P_{1x1} (mW)		6.8		6.8		
	z_s (cm)			0.9			
	z_b (cm)					0.9	
	z_{MI} (cm)	0.8					
	$z_{pii,\alpha}$ (cm)	0.8					
	f_{awf} (MHz)	6.00	6.01		6.01		#
Other information	prf (Hz)	1562					
	srr (Hz)	—					
	η_{pps}	1					
	$I_{pa,\alpha}$ at $z_{pii,\alpha}$ (W/cm^2)	6.4					
	$I_{spta,\alpha}$ at $z_{pii,\alpha}$ or $z_{sii,\alpha}$ (mW/cm^2)	24.7					
	I_{spta} at z_{pii} or z_{sii} (mW/cm^2)	36.1					
	p_r at z_{pii} (MPa)	0.5					
Operating controls	Exam type	Oph	Oph		Oph		
	Sample volume size (mm)	2	3		3		
	Sample volume position	Zone 2	Zone 11		Zone 11		
	PRF (Hz)	1562	5208		5208		

(a) This index is not required for this operating mode; value is <1.

(b) This transducer is not intended for transcranial or neonatal cephalic uses.

No data are reported for this operating condition since the global maximum index value is not reported for the reason listed. (Reference global maximum index value line.)

— Data are not applicable for this transducer/mode.

Table 10-36: Transducer model: L25xp Operating mode: 2D

Index label		MI	TIS		TIB		TIC
			At surface	Below surface	At surface	Below surface	At surface
Maximum index value		1.0	(a)		(a)		(b)
Index component value			#	#	#	#	
Acoustic parameters	$p_{r,\alpha}$ at z_{MI} (MPa)	2.42					
	P (mW)		#		#		#
	P_{1x1} (mW)		#		#		
	z_s (cm)			—			
	z_b (cm)					—	
	z_{MI} (cm)	0.9					
	$z_{pii,\alpha}$ (cm)	0.9					
	f_{awf} (MHz)	6.08	#		#		#
Other information	pr (Hz)	783					
	srr (Hz)	12.1					
	η_{pps}	1					
	$I_{pa,\alpha}$ at $z_{pii,\alpha}$ (W/cm^2)	328					
	$I_{spta,\alpha}$ at $z_{pii,\alpha}$ or $z_{sii,\alpha}$ (mW/cm^2)	4.9					
	I_{spta} at z_{pii} or z_{sii} (mW/cm^2)	7.3					
	p_r at z_{pii} (MPa)	2.92					
Operating controls	Exam type	Ven					
	Optimization	Res					
	Depth (cm)	2.4					
	MB	On					
	Needle profiling	On					

(a) This index is not required for this operating mode; value is <1.

(b) This transducer is not intended for transcranial or neonatal cephalic uses.

No data are reported for this operating condition since the global maximum index value is not reported for the reason listed. (Reference global maximum index value line.)

— Data are not applicable for this transducer/mode.

Table 10-37: Transducer model: L25xp Operating mode: 2D + M Mode

Index label		MI	TIS		TIB		TIC
			At surface	Below surface	At surface	Below surface	At surface
Maximum index value		1.1	(a)		(a)		(b)
Index component value			#	#	#	#	
Acoustic parameters	$p_{r,\alpha}$ at z_{MI} (MPa)	3.05					
	P (mW)		#		#		#
	$P_{1 \times 1}$ (mW)		#		#		
	z_s (cm)			#			
	z_b (cm)					#	
	z_{MI} (cm)	1.0					
	$z_{pii,\alpha}$ (cm)	1.0					
f_{awf} (MHz)	7.08		#		#		#
Other information	pr (Hz)	400					
	srr (Hz)	40					
	η_{pps}	1					
	$I_{pa,\alpha}$ at $z_{pii,\alpha}$ (W/cm^2)	362					
	$I_{spta,\alpha}$ at $z_{pii,\alpha}$ or $z_{sii,\alpha}$ (mW/cm^2)	26.2					
	I_{spta} at z_{pii} or z_{sii} (mW/cm^2)	41.9					
p_r at z_{pii} (MPa)	3.88						
Operating controls	Exam type	Lung					
	Optimization	Res					
	Depth (cm)	2.0					
	MB	Off					

(a) This index is not required for this operating mode; value is <1.

(b) This transducer is not intended for transcranial or neonatal cephalic uses.

No data are reported for this operating condition since the global maximum index value is not reported for the reason listed. (Reference global maximum index value line.)

— Data are not applicable for this transducer/mode.

Table 10-38: Transducer model: L25xp Operating mode: Color/CPD

Index label		MI	TIS		TIB		TIC
			At surface	Below surface	At surface	Below surface	At surface
Maximum index value		1.1	(a)		(a)		(b)
Index component value			#	#	#	#	
Acoustic parameters	$p_{r,\alpha}$ at z_{MI} (MPa)	2.81					
	P (mW)		#		#		#
	$P_{1 \times 1}$ (mW)		#		#		
	z_s (cm)			—			
	z_b (cm)					—	
	z_{MI} (cm)	1.0					
	$z_{pii,\alpha}$ (cm)	1.0					
	f_{awf} (MHz)	7.08	#		#		#
Other information	pr_r (Hz)	1717					
	srr (Hz)	13.3					
	n_{pps}	1					
	$I_{pa,\alpha}$ at $z_{pii,\alpha}$ (W/cm^2)	321					
	$I_{spta,\alpha}$ at $z_{pii,\alpha}$ or $z_{sij,\alpha}$ (mW/cm^2)	2.8					
	I_{spta} at z_{pii} or z_{sij} (mW/cm^2)	4.4					
	p_r at z_{pii} (MPa)	3.6					
Operating controls	Exam type	Msk					
	Mode	CPD					
	2D optimization/depth (cm)	Res/2.0					
	Color optimization/PRF (Hz)	Low/312					
	Color box position/size	Default/narrow					

(a) This index is not required for this operating mode; value is <1.

(b) This transducer is not intended for transcranial or neonatal cephalic uses.

No data are reported for this operating condition since the global maximum index value is not reported for the reason listed. (Reference global maximum index value line.)

— Data are not applicable for this transducer/mode.

Table 10-39: Transducer model: L25xp Operating mode: PW Doppler

Index label		MI	TIS		TIB		TIC
			At surface	Below surface	At surface	Below surface	At surface
Maximum index value		(a)	(a)		1.1		(b)
Index component value			#	#	0.4	1.1	
Acoustic parameters	$p_{r,\alpha}$ at z_{MI} (MPa)	#					
	P (mW)		#		14.67		#
	P_{1x1} (mW)		#		14.7		
	z_s (cm)			#			
	z_b (cm)					1.40	
	z_{MI} (cm)	#					
	$z_{pii,\alpha}$ (cm)	#					
Other information	f_{awf} (MHz)	#	#		6.01		#
	pr (Hz)	#					
	srr (Hz)	#					
	η_{pps}	#					
	$I_{pa,\alpha}$ at $z_{pii,\alpha}$ (W/cm ²)	#					
	$I_{spta,\alpha}$ at $z_{pii,\alpha}$ or $z_{sii,\alpha}$ (mW/cm ²)	#					
	I_{spta} at z_{pii} or z_{sii} (mW/cm ²)	#					
p_r at z_{pii} (MPa)	#						
Operating controls	Exam type				Ven		
	Sample volume size (mm)				3		
	Sample volume position				Zone 6 (24 mm)		
	PRF (Hz)				1562		

(a) This index is not required for this operating mode; value is <1.

(b) This transducer is not intended for transcranial or neonatal cephalic uses.

No data are reported for this operating condition since the global maximum index value is not reported for the reason listed. (Reference global maximum index value line.)

— Data are not applicable for this transducer/mode.

Table 10-40: Transducer model: L25xp Operating mode: 2D + PW Doppler

Index label		MI	TIS		TIB		TIC
			At surface	Below surface	At surface	Below surface	At surface
Maximum index value		1.1	(a)		(a)		(b)
Index component value			#	#	#	#	
Acoustic parameters	$p_{r,\alpha}$ at z_{MI} (MPa)	2.98					
	P (mW)		#		#		#
	P_{1x1} (mW)		#		#		
	z_s (cm)			#			
	z_b (cm)					#	
	z_{MI} (cm)	1.0					
	$z_{pii,\alpha}$ (cm)	1.0					
	f_{awf} (MHz)	6.81	#		#		#
Other information	pr (Hz)	7670					
	srr (Hz)	47.3					
	η_{pps}	1					
	$I_{pa,\alpha}$ at $z_{pii,\alpha}$ (W/cm^2)	374					
	$I_{spta,\alpha}$ at $z_{pii,\alpha}$ or $z_{sii,\alpha}$ (mW/cm^2)	12.3					
	I_{spta} at z_{pii} or z_{sii} (mW/cm^2)	18.8					
	p_r at z_{pii} (MPa)	3.77					
Operating controls	Exam type	Ven					
	2D optimization	Gen					
	Depth (cm)	2.0					
	Sample volume size (mm)	1					
	Sample volume position	Zone 0					
	PRF (Hz)	1562					

(a) This index is not required for this operating mode; value is <1.

(b) This transducer is not intended for transcranial or neonatal cephalic uses.

No data are reported for this operating condition since the global maximum index value is not reported for the reason listed. (Reference global maximum index value line.)

— Data are not applicable for this transducer/mode.

Table 10-41: Transducer model: L25xp Operating mode: 2D + Color + PW Doppler

Index label		MI	TIS		TIB		TIC
			At surface	Below surface	At surface	Below surface	At surface
Maximum index value		1.0	(a)		(a)		(b)
Index component value			#	#	#	#	
Acoustic parameters	$p_{r,\alpha}$ at z_{MI} (MPa)	2.62					
	P (mW)		#		#		#
	P_{1x1} (mW)		#		#		
	z_s (cm)			#			
	z_b (cm)					#	
	z_{MI} (cm)	1.1					
	$z_{pii,\alpha}$ (cm)	1.1					
f_{awf} (MHz)	7.15		#		#		#
Other information	prf (Hz)	1154					
	srr (Hz)	8.9					
	η_{pps}	1					
	$I_{pa,\alpha}$ at $z_{pii,\alpha}$ (W/cm ²)	267					
	$I_{spta,\alpha}$ at $z_{pii,\alpha}$ or $z_{sii,\alpha}$ (mW/cm ²)	2.0					
	I_{spta} at z_{pii} or z_{sii} (mW/cm ²)	3.1					
p_r at z_{pii} (MPa)	3.46						
Operating controls	Exam type	Ven					
	2D optimization	Res					
	Depth (cm)	3.1					
	Color box position/size	Default/wide					
	Sample volume size (mm)	1					
	Sample volume position	Zone 0					
PRF (Hz)	1562						

(a) This index is not required for this operating mode; value is <1.

(b) This transducer is not intended for transcranial or neonatal cephalic uses.

No data are reported for this operating condition since the global maximum index value is not reported for the reason listed. (Reference global maximum index value line.)

— Data are not applicable for this transducer/mode.

Table 10-42: Transducer model: L25xp (Ophthalmic) Operating mode: 2D

Index label		MI	TIS		TIB		TIC
			At surface	Below surface	At surface	Below surface	At surface
Maximum index value		0.17	0.03		0.03		(b)
Index component value			0.03	0.03	0.03	0.03	
Acoustic parameters	$p_{r,\alpha}$ at z_{MI} (MPa)	0.45					
	P (mW)		1.9		1.9		#
	P_{1x1} (mW)		0.8		0.8		
	z_s (cm)			—			
	z_b (cm)					—	
	z_{MI} (cm)	2.3					
	$z_{pii,\alpha}$ (cm)	2.3					
	f_{awf} (MHz)	6.85	7.15		7.15		#
Other information	pr (Hz)	10710					
	srr (Hz)	13.8					
	n_{pps}	6					
	$I_{pa,\alpha}$ at $z_{pii,\alpha}$ (W/cm^2)	11					
	$I_{spta,\alpha}$ at $z_{pii,\alpha}$ or $z_{sii,\alpha}$ (mW/cm^2)	2.4					
	I_{spta} at z_{pii} or z_{sii} (mW/cm^2)	4.0					
p_r at z_{pii} (MPa)	0.78						
Operating controls	Exam type	Oph	Oph		Oph		
	Optimization	Gen	Gen		Gen		
	Depth (cm)	4.9	6.0		6.0		
	MB	On	On		On		

(a) This index is not required for this operating mode; value is < 1.

(b) This transducer is not intended for transcranial or neonatal cephalic uses.

No data are reported for this operating condition since the global maximum index value is not reported for the reason listed. (Reference global maximum index value line.)

— Data are not applicable for this transducer/mode.

Table 10-43: Transducer model: L25xp (Ophthalmic) Operating mode: 2D + M Mode

Index label		MI	TIS		TIB		TIC
			At surface	Below surface	At surface	Below surface	At surface
Maximum index value		0.17	0.029		0.031		(b)
Index component value			0.029	0.028	0.029	0.031	
Acoustic parameters	$p_{r,\alpha}$ at z_{MI} (MPa)	0.46					
	P (mW)		1.72		1.72		#
	P_{1x1} (mW)		0.79		0.79		
	z_s (cm)			0.8			
	z_b (cm)					1.05	
	z_{MI} (cm)	1.25					
	$z_{pii,\alpha}$ (cm)	1.25					
	f_{awf} (MHz)	7.48	7.77		7.77		#
Other information	prf (Hz)	400					
	srr (Hz)	30.8					
	η_{pps}	1					
	$I_{pa,\alpha}$ at $z_{pii,\alpha}$ (W/cm^2)	15.5					
	$I_{spta,\alpha}$ at $z_{pii,\alpha}$ or $z_{sii,\alpha}$ (mW/cm^2)	1.0					
	I_{spta} at z_{pii} or z_{sii} (mW/cm^2)	1.9					
	p_r at z_{pii} (MPa)	0.63					
Operating controls	Exam type	Oph	Oph		Oph		
	Optimization	Gen	Res		Res		
	Depth (cm)	2.0	4.2		4.2		

(a) This index is not required for this operating mode; value is <1.

(b) This transducer is not intended for transcranial or neonatal cephalic uses.

No data are reported for this operating condition since the global maximum index value is not reported for the reason listed. (Reference global maximum index value line.)

— Data are not applicable for this transducer/mode.

Table 10-44: Transducer model: L25xp (Ophthalmic) Operating mode: Color/CPD

Index label		MI	TIS		TIB		TIC
			At surface	Below surface	At surface	Below surface	At surface
Maximum index value		0.17	0.08		0.08		(b)
Index component value			0.08	0.08	0.08	0.08	
Acoustic parameters	$p_{r,\alpha}$ at z_{MI} (MPa)	0.47					
	P (mW)		3.8		3.8		#
	$P_{1 \times 1}$ (mW)		2.6		2.6		
	z_s (cm)			—			
	z_b (cm)					—	
	z_{MI} (cm)	1.9					
	$z_{pii,\alpha}$ (cm)	1.9					
	f_{awf} (MHz)	7.77	6.10		6.10		#
Other information	pr_r (Hz)	2424					
	srr (Hz)	18.6					
	n_{pps}	1					
	$I_{pa,\alpha}$ at $z_{pii,\alpha}$ (W/cm^2)	17.7					
	$I_{spta,\alpha}$ at $z_{pii,\alpha}$ or $z_{sij,\alpha}$ (mW/cm^2)	0.4					
	I_{spta} at z_{pii} or z_{sij} (mW/cm^2)	0.8					
	p_r at z_{pii} (MPa)	0.78					
Operating controls	Exam type	Oph	Oph		Oph		
	Mode	CPD	CPD		CPD		
	2D optimization/depth (cm)	Res/4.2	Res/4.9		Res/4.9		
	Color optimization/PRF (Hz)	Low/1250	Low/781		Low/781		
	Color box position/size	Top/wide and short	Bottom/default		Bottom/default		

(a) This index is not required for this operating mode; value is <1.

(b) This transducer is not intended for transcranial or neonatal cephalic uses.

No data are reported for this operating condition since the global maximum index value is not reported for the reason listed. (Reference global maximum index value line.)

— Data are not applicable for this transducer/mode.

Table 10-45: Transducer model: L25xp (Ophthalmic) Operating mode: PW Doppler

Index label		MI	TIS		TIB		TIC
			At surface	Below surface	At surface	Below surface	At surface
Maximum index value		0.17	0.19		0.26		(b)
Index component value			0.19	0.13	0.19	0.26	
Acoustic parameters	$p_{r,\alpha}$ at z_{MI} (MPa)	0.42					
	P (mW)		6.8		6.8		#
	P_{1x1} (mW)		6.8		6.8		
	z_s (cm)		0.9				
	z_b (cm)					0.9	
	z_{MI} (cm)	0.8					
	$z_{pii,\alpha}$ (cm)	0.8					
f_{awf} (MHz)	6.00	6.01		6.01		#	
Other information	prf (Hz)	1562					
	srr (Hz)	—					
	η_{pps}	1					
	$I_{pa,\alpha}$ at $z_{pii,\alpha}$ (W/cm^2)	6.4					
	$I_{spta,\alpha}$ at $z_{pii,\alpha}$ or $z_{sii,\alpha}$ (mW/cm^2)	24.7					
	I_{spta} at z_{pii} or z_{sii} (mW/cm^2)	36.1					
p_r at z_{pii} (MPa)	0.5						
Operating controls	Exam type	Oph	Oph		Oph		
	Sample volume size (mm)	2	3		3		
	Sample volume position	Zone 2	Zone 11		Zone 11		
	PRF (Hz)	1562	5208		5208		

(a) This index is not required for this operating mode; value is <1.

(b) This transducer is not intended for transcranial or neonatal cephalic uses.

No data are reported for this operating condition since the global maximum index value is not reported for the reason listed. (Reference global maximum index value line.)

— Data are not applicable for this transducer/mode.

Table 10-46: Transducer model: ICTxp Operating mode: 2D + M Mode

Index label		MI	TIS		TIB		TIC
			At surface	Below surface	At surface	Below surface	At surface
Maximum index value		1.0	(a)		(a)		(b)
Index component value			#	#	#	#	
Acoustic parameters	$p_{r,\alpha}$ at z_{MI} (MPa)	2.02					
	P (mW)		#		#		#
	P_{1x1} (mW)		#		#		
	z_s (cm)			#			
	z_b (cm)					#	
	z_{MI} (cm)	1.5					
	$z_{pii,\alpha}$ (cm)	1.5					
	f_{awf} (MHz)	4.64	#		#		#
Other information	pr (Hz)	400					
	srr (Hz)	17.4					
	η_{pps}	1					
	$I_{pa,\alpha}$ at $z_{pii,\alpha}$ (W/cm^2)	247					
	$I_{spta,\alpha}$ at $z_{pii,\alpha}$ or $z_{sii,\alpha}$ (mW/cm^2)	31.1					
	I_{spta} at z_{pii} or z_{sii} (mW/cm^2)	50.6					
	p_r at z_{pii} (MPa)	2.57					
Operating controls	Exam type	Gyn					
	Optimization	Gen					
	Depth (cm)	4.1					

(a) This index is not required for this operating mode; value is <1.

(b) This transducer is not intended for transcranial or neonatal cephalic uses.

No data are reported for this operating condition since the global maximum index value is not reported for the reason listed. (Reference global maximum index value line.)

— Data are not applicable for this transducer/mode.

Table 10-47: Transducer model: ICTxp Operating mode: PW Doppler

Index label		MI	TIS		TIB		TIC
			At surface	Below surface	At surface	Below surface	At surface
Maximum index value		1.0	(a)		1.3		(b)
Index component value			#	#	0.3	1.3	
Acoustic parameters	$p_{r,\alpha}$ at z_{MI} (MPa)	2.01					
	P (mW)		#		15.86		#
	P_{1x1} (mW)		#		15.6		
	z_s (cm)			#			
	z_b (cm)					1.30	
	z_{MI} (cm)	1.4					
	$z_{pii,\alpha}$ (cm)	1.4					
	f_{awf} (MHz)	4.38	#		4.38		#
Other information	prf (Hz)	1302					
	srr (Hz)	—					
	η_{pps}	1					
	$I_{pa,\alpha}$ at $z_{pii,\alpha}$ (W/cm^2)	263					
	$I_{spta,\alpha}$ at $z_{pii,\alpha}$ or $z_{sii,\alpha}$ (mW/cm^2)	392.0					
	I_{spta} at z_{pii} or z_{sii} (mW/cm^2)	623.8					
	p_r at z_{pii} (MPa)	2.49					
Operating controls	Exam type	Ob			Ob		
	Sample volume size (mm)	1			1		
	Sample volume position	Zone 2			Zone 2		
	PRF (Hz)	1302			1302		

(a) This index is not required for this operating mode; value is <1.

(b) This transducer is not intended for transcranial or neonatal cephalic uses.

No data are reported for this operating condition since the global maximum index value is not reported for the reason listed. (Reference global maximum index value line.)

— Data are not applicable for this transducer/mode.

Table 10-48: Transducer model: L38xp Operating mode: 2D

Index label		MI	TIS		TIB		TIC
			At surface	Below surface	At surface	Below surface	At surface
Maximum index value		1.5	(a)		(a)		(b)
Index component value			#	#	#	#	
Acoustic parameters	$p_{r,\alpha}$ at z_{MI} (MPa)	3.32					
	P (mW)		#		#		#
	P_{1x1} (mW)		#		#		
	z_s (cm)			—			
	z_b (cm)					—	
	z_{MI} (cm)	1.1					
	$z_{pii,\alpha}$ (cm)	1.1					
	f_{awf} (MHz)	4.83	#		#		#
Other information	pr (Hz)	790					
	srr (Hz)	12.2					
	η_{pps}	1					
	$I_{pa,\alpha}$ at $z_{pii,\alpha}$ (W/cm^2)	622					
	$I_{spta,\alpha}$ at $z_{pii,\alpha}$ or $z_{sii,\alpha}$ (mW/cm^2)	6.6					
	I_{spta} at z_{pii} or z_{sii} (mW/cm^2)	9.1					
	p_r at z_{pii} (MPa)	4.02					
Operating controls	Exam type	Ven					
	Optimization	Gen					
	Depth (cm)	3.5					
	MB	On/off					
	Needle profiling	On/off					

(a) This index is not required for this operating mode; value is <1.

(b) This transducer is not intended for transcranial or neonatal cephalic uses.

No data are reported for this operating condition since the global maximum index value is not reported for the reason listed. (Reference global maximum index value line.)

— Data are not applicable for this transducer/mode.

Table 10-49: Transducer model: L38xp Operating mode: 2D + M Mode

Index label		MI	TIS		TIB		TIC
			At surface	Below surface	At surface	Below surface	At surface
Maximum index value		1.3	(a)		(a)		(b)
Index component value			#	#	#	#	
Acoustic parameters	$p_{r,\alpha}$ at z_{MI} (MPa)	3.26					
	P (mW)		#		#		#
	$P_{1 \times 1}$ (mW)		#		#		
	z_s (cm)			#			
	z_b (cm)					#	
	z_{MI} (cm)	1.2					
	$z_{pii,\alpha}$ (cm)	1.2					
f_{awf} (MHz)	6.42		#		#		#
Other information	pr (Hz)	400					
	srr (Hz)	40					
	η_{pps}	1					
	$I_{pa,\alpha}$ at $z_{pii,\alpha}$ (W/cm^2)	610					
	$I_{spta,\alpha}$ at $z_{pii,\alpha}$ or $z_{sii,\alpha}$ (mW/cm^2)	58.6					
	I_{spta} at z_{pii} or z_{sii} (mW/cm^2)	102.3					
p_r at z_{pii} (MPa)	4.25						
Operating controls	Exam type	Lung					
	Optimization	Gen					
	Depth (cm)	2.0					
	MB	Off					

(a) This index is not required for this operating mode; value is <1.

(b) This transducer is not intended for transcranial or neonatal cephalic uses.

No data are reported for this operating condition since the global maximum index value is not reported for the reason listed. (Reference global maximum index value line.)

— Data are not applicable for this transducer/mode.

Table 10-50: Transducer model: L38xp Operating mode: Color/CPD

Index label		MI	TIS		TIB		TIC
			At surface	Below surface	At surface	Below surface	At surface
Maximum index value		1.5	(a)		(a)		(b)
Index component value			#	#	#	#	
Acoustic parameters	$p_{r,\alpha}$ at z_{MI} (MPa)	3.2					
	P (mW)		#		#		#
	$P_{1 \times 1}$ (mW)		#		#		
	z_s (cm)			—			
	z_b (cm)					—	
	z_{MI} (cm)	1.1					
	$z_{pii,\alpha}$ (cm)	1.1					
	f_{awf} (MHz)	4.63		#		#	#
Other information	pr_r (Hz)	5064					
	srr (Hz)	5.6					
	n_{pps}	12					
	$I_{pa,\alpha}$ at $z_{pii,\alpha}$ (W/cm ²)	678					
	$I_{spta,\alpha}$ at $z_{pii,\alpha}$ or $z_{sij,\alpha}$ (mW/cm ²)	69.0					
	I_{spta} at z_{pii} or z_{sij} (mW/cm ²)	93.9					
	p_r at z_{pii} (MPa)	3.78					
Operating controls	Exam type	Ven					
	Mode	Color					
	2D optimization/depth (cm)	Gen/3.5					
	Color optimization/PRF (Hz)	High/6250					
	Color box position/size	Default/wide and tall					

(a) This index is not required for this operating mode; value is <1.

(b) This transducer is not intended for transcranial or neonatal cephalic uses.

No data are reported for this operating condition since the global maximum index value is not reported for the reason listed. (Reference global maximum index value line.)

— Data are not applicable for this transducer/mode.

Table 10-51: Transducer model: L38xp Operating mode: PW Doppler

Index label		MI	TIS		TIB		TIC
			At surface	Below surface	At surface	Below surface	At surface
Maximum index value		1.0	2.0		2.9		(b)
Index component value			2.0	1.4	2.0	2.9	
Acoustic parameters	$p_{r,\alpha}$ at z_{MI} (MPa)	2.21					
	P (mW)		80.5		80.5		#
	P_{1x1} (mW)		80.5		80.5		
	z_s (cm)			1.00			
	z_b (cm)					1.00	
	z_{MI} (cm)	0.3					
	$z_{pii,\alpha}$ (cm)	0.3					
f_{awf} (MHz)	5.28		5.33		5.33		#
Other information	pr (Hz)	1562					
	srr (Hz)	—					
	η_{pps}	1					
	$I_{pa,\alpha}$ at $z_{pii,\alpha}$ (W/cm^2)	210					
	$I_{spta,\alpha}$ at $z_{pii,\alpha}$ or $z_{sii,\alpha}$ (mW/cm^2)	393.8					
	I_{spta} at z_{pii} or z_{sii} (mW/cm^2)	425.6					
p_r at z_{pii} (MPa)	2.33						
Operating controls	Exam type	Nrv	Nrv		Nrv		
	Sample volume size (mm)	1	3		3		
	Sample volume position	Zone 0	Zone 11		Zone 11		
	PRF (Hz)	1562	1562		1562		

(a) This index is not required for this operating mode; value is <1.

(b) This transducer is not intended for transcranial or neonatal cephalic uses.

No data are reported for this operating condition since the global maximum index value is not reported for the reason listed. (Reference global maximum index value line.)

— Data are not applicable for this transducer/mode.

Table 10-52: Transducer model: L38xp Operating mode: 2D + PW Doppler

Index label		MI	TIS		TIB		TIC
			At surface	Below surface	At surface	Below surface	At surface
Maximum index value		1.5	1.0		1.7		(b)
Index component value			1.0	0.7	0.6	1.7	
Acoustic parameters	$p_{r,\alpha}$ at z_{MI} (MPa)	3.37					
	P (mW)		52.0		41.3		#
	P_{1x1} (mW)		38.7		31.6		
	z_s (cm)			1.4			
	z_b (cm)					1.1	
	z_{MI} (cm)	1.2					
	$z_{pii,\alpha}$ (cm)	1.2					
	f_{awf} (MHz)	5.22	5.33		4.03		#
Other information	pr (Hz)	3125					
	srr (Hz)	24.2					
	n_{pps}	1					
	$I_{pa,\alpha}$ at $z_{pii,\alpha}$ (W/cm^2)	538					
	$I_{spta,\alpha}$ at $z_{pii,\alpha}$ or $z_{sii,\alpha}$ (mW/cm^2)	52.6					
	I_{spta} at z_{pii} or z_{sii} (mW/cm^2)	74.7					
	p_r at z_{pii} (MPa)	4.18					
Operating controls	Exam type	Ven	Ven		Art		
	2D optimization	Gen	Gen		Gen		
	Depth (cm)	2.0	9.0		4.0		
	Sample volume size (mm)	1	2		2		
	Sample volume position	Zone 0	Zone 11		Zone 6		
	PRF (Hz)	3125	7812		6250		

(a) This index is not required for this operating mode; value is <1.

(b) This transducer is not intended for transcranial or neonatal cephalic uses.

No data are reported for this operating condition since the global maximum index value is not reported for the reason listed. (Reference global maximum index value line.)

— Data are not applicable for this transducer/mode.

Table 10-53: Transducer model: L38xp Operating mode: 2D + Color + PW Doppler

Index label		MI	TIS		TIB		TIC
			At surface	Below surface	At surface	Below surface	At surface
Maximum index value		1.5	1.0		1.5		(b)
Index component value			1.0	0.7	0.7	1.5	
Acoustic parameters	$p_{r,\alpha}$ at z_{MI} (MPa)	3.2					
	P (mW)		49.3		38.7		#
	$P_{1 \times 1}$ (mW)		41.6		34.4		
	z_s (cm)			1.4			
	z_b (cm)					1.1	
	z_{MI} (cm)	1.1					
	$z_{pii,\alpha}$ (cm)	1.1					
	f_{awf} (MHz)	4.63	5.33		4.03		#
Other information	prf (Hz)	2831					
	srr (Hz)	7.0					
	n_{pps}	14					
	$I_{pa,\alpha}$ at $z_{pii,\alpha}$ (W/cm ²)	678					
	$I_{spta,\alpha}$ at $z_{pii,\alpha}$ or $z_{sij,\alpha}$ (mW/cm ²)	75.5					
	I_{spta} at z_{pii} or z_{sij} (mW/cm ²)	102.8					
	p_r at z_{pii} (MPa)	3.78					
Operating controls	Exam type	Art	Ven		Art		
	2D optimization	Pen	Gen		Gen		
	Depth (cm)	7.9	9.0		6.9		
	Color box position/size	Default/default	Default/narrow		Default/narrow		
	Sample volume size (mm)	3	2		2		
	Sample volume position	Zone 2	Zone 11		Zone 6		
	PRF (Hz)	5208	6250		10417		

(a) This index is not required for this operating mode; value is < 1.

(b) This transducer is not intended for transcranial or neonatal cephalic uses.

No data are reported for this operating condition since the global maximum index value is not reported for the reason listed. (Reference global maximum index value line.)

— Data are not applicable for this transducer/mode.

Table 10-54: Transducer model: P10xp Operating mode: 2D

Index label		MI	TIS		TIB		TIC
			At surface	Below surface	At surface	Below surface	At surface
Maximum index value		1.4	(a)		(a)		1.0
Index component value			#	#	#	#	
Acoustic parameters	$p_{r,\alpha}$ at z_{MI} (MPa)	3.13					
	P (mW)		#		#		37.1
	P_{1x1} (mW)		#		#		
	z_s (cm)			—			
	z_b (cm)					—	
	z_{MI} (cm)	1.0					
	$z_{pii,\alpha}$ (cm)	1.0					
	f_{awf} (MHz)	4.71	#		#		4.47
Other information	pr (Hz)	2500					
	srr (Hz)	19.4					
	η_{pps}	1					
	$I_{pa,\alpha}$ at $z_{pii,\alpha}$ (W/cm^2)	420					
	$I_{spta,\alpha}$ at $z_{pii,\alpha}$ or $z_{sii,\alpha}$ (mW/cm^2)	24.2					
	I_{spta} at z_{pii} or z_{sii} (mW/cm^2)	28.3					
	p_r at z_{pii} (MPa)	3.67					
Operating controls	Exam type	Abd					Crd
	Optimization	Gen					Gen
	Depth (cm)	3.0					4.0
	Sector size	N/A					Narrow

(a) This index is not required for this operating mode; value is <1.

(b) This transducer is not intended for transcranial or neonatal cephalic uses.

No data are reported for this operating condition since the global maximum index value is not reported for the reason listed. (Reference global maximum index value line.)

— Data are not applicable for this transducer/mode.

Table 10-55: Transducer model: P10xp Operating mode: 2D + M Mode

Index label		MI	TIS		TIB		TIC
			At surface	Below surface	At surface	Below surface	At surface
Maximum index value		1.3	(a)		(a)		(a)
Index component value			#	#	#	#	
Acoustic parameters	$p_{r,\alpha}$ at z_{MI} (MPa)	2.83					
	P (mW)		#		#		#
	P_{1x1} (mW)		#		#		
	z_s (cm)			#			
	z_b (cm)					#	
	z_{MI} (cm)	0.5					
	$z_{pii,\alpha}$ (cm)	0.5					
	f_{awf} (MHz)	4.67	#		#		#
Other information	pr (Hz)	400					
	srr (Hz)	30.8					
	η_{pps}	1					
	$I_{pa,\alpha}$ at $z_{pii,\alpha}$ (W/cm^2)	289					
	$I_{spta,\alpha}$ at $z_{pii,\alpha}$ or $z_{sii,\alpha}$ (mW/cm^2)	39.0					
	I_{spta} at z_{pii} or z_{sii} (mW/cm^2)	46.0					
	p_r at z_{pii} (MPa)	3.07					
Operating controls	Exam type	Crd					
	Optimization	Gen					
	Depth (cm)	2.0					

(a) This index is not required for this operating mode; value is <1.

(b) This transducer is not intended for transcranial or neonatal cephalic uses.

No data are reported for this operating condition since the global maximum index value is not reported for the reason listed. (Reference global maximum index value line.)

— Data are not applicable for this transducer/mode.

Table 10-56: Transducer model: P10xp Operating mode: Color/CPD

Index label		MI	TIS		TIB		TIC
			At surface	Below surface	At surface	Below surface	At surface
Maximum index value		(a)	(a)		(a)		1.3
Index component value			#	#	#	#	
Acoustic parameters	$p_{r,\alpha}$ at z_{MI} (MPa)	#					
	P (mW)		#		#		32.7
	$P_{1 \times 1}$ (mW)		#		#		
	z_s (cm)			—			
	z_b (cm)					—	
	z_{MI} (cm)	#					
	$z_{pii,\alpha}$ (cm)	#					
f_{awf} (MHz)	#	#		#		4.08	
Other information	p_{rr} (Hz)	#					
	s_{rr} (Hz)	#					
	η_{pps}	#					
	$I_{pa,\alpha}$ at $z_{pii,\alpha}$ (W/cm^2)	#					
	$I_{spta,\alpha}$ at $z_{pii,\alpha}$ or $z_{sij,\alpha}$ (mW/cm^2)	#					
	I_{spta} at z_{pii} or z_{sij} (mW/cm^2)	#					
p_r at z_{pii} (MPa)	#						
Operating controls	Exam type						Abd
	Mode						Color
	2D optimization/depth (cm)						Gen/2.0
	Color optimization/PRF (Hz)						Low/521
	Color box position/size						Default/narrow

(a) This index is not required for this operating mode; value is <1.

(b) This transducer is not intended for transcranial or neonatal cephalic uses.

No data are reported for this operating condition since the global maximum index value is not reported for the reason listed. (Reference global maximum index value line.)

— Data are not applicable for this transducer/mode.

Table 10-57: Transducer model: P10xp Operating mode: PW Doppler

Index label		MI	TIS		TIB		TIC
			At surface	Below surface	At surface	Below surface	At surface
Maximum index value		1.1	1.1		1.9		1.6
Index component value			1.1	0.6	0.6	1.9	
Acoustic parameters	$p_{r,\alpha}$ at z_{MI} (MPa)	2.24					
	P (mW)		34.3		31.3		24.0
	P_{1x1} (mW)		34.3		31.3		
	z_s (cm)		1.3				
	z_b (cm)					0.80	
	z_{MI} (cm)	0.8					
	$z_{pii,\alpha}$ (cm)	0.8					
	f_{awf} (MHz)	4.03	6.85		4.01		4.00
Other information	pr_r (Hz)	1562					
	srr (Hz)	—					
	η_{pps}	1					
	$I_{pa,\alpha}$ at $z_{pii,\alpha}$ (W/cm ²)	209					
	$I_{spta,\alpha}$ at $z_{pii,\alpha}$ or $z_{sii,\alpha}$ (mW/cm ²)	363.9					
	I_{spta} at z_{pii} or z_{sii} (mW/cm ²)	610.7					
	p_r at z_{pii} (MPa)	2.5					
Operating controls	Exam type	Crd	Crd		Crd		Crd
	Sample volume size (mm)	1	2		2		2
	Sample volume position	Zone 2 (15 mm)	Zone 10 (108 mm)		Zone 2 (15 mm)		Zone 0 (5 mm)
	PRF (Hz)	1563	1008		1563		1563
	TDI	Off	On		Off		Off

(a) This index is not required for this operating mode; value is <1.

(b) This transducer is not intended for transcranial or neonatal cephalic uses.

No data are reported for this operating condition since the global maximum index value is not reported for the reason listed. (Reference global maximum index value line.)

— Data are not applicable for this transducer/mode.

Table 10-58: Transducer model: P10xp Operating mode: CW Doppler

Index label		MI	TIS		TIB		TIC
			At surface	Below surface	At surface	Below surface	At surface
Maximum index value		(a)	(a)		2.4		1.5
Index component value			#	#	0.7	2.4	
Acoustic parameters	$p_{r,\alpha}$ at z_{MI} (MPa)	#					
	P (mW)		#		34.3		37.4
	P_{1x1} (mW)		#		34.3		
	z_s (cm)			#			
	z_b (cm)					0.50	
	z_{MI} (cm)	#					
	$z_{pii,\alpha}$ (cm)	#					
	f_{awf} (MHz)	#	#		4.00		4.00
Other information	pr (Hz)	#					
	srr (Hz)	#					
	η_{pps}	#					
	$I_{pa,\alpha}$ at $z_{pii,\alpha}$ (W/cm^2)	#					
	$I_{spta,\alpha}$ at $z_{pii,\alpha}$ or $z_{sii,\alpha}$ (mW/cm^2)	#					
	I_{spta} at z_{pii} or z_{sii} (mW/cm^2)	#					
Operating controls	p_r at z_{pii} (MPa)	#					
	Exam type				Crd		Crd
	Sample volume position				Zone 1 (9 mm)	Zone 2 (15 mm)	

(a) This index is not required for this operating mode; value is <1.
 (b) This transducer is not intended for transcranial or neonatal cephalic uses.
 # No data are reported for this operating condition since the global maximum index value is not reported for the reason listed. (Reference global maximum index value line.)
 — Data are not applicable for this transducer/mode.

Table 10-59: Transducer model: P2 1xp Operating mode: 2D

Index label		MI	TIS		TIB		TIC
			At surface	Below surface	At surface	Below surface	At surface
Maximum index value		1.5	(a)		(a)		2.0
Index component value			#	#	#	#	
Acoustic parameters	$p_{r,\alpha}$ at z_{MI} (MPa)	2.02					
	P (mW)		#		#		146.2
	P_{1x1} (mW)		#		#		
	z_s (cm)			—			
	z_b (cm)					—	
	z_{MI} (cm)	4.1					
	$z_{pii,\alpha}$ (cm)	4.1					
f_{awf} (MHz)	1.85		#		#		2.09
Other information	pr_r (Hz)	2933					
	srr (Hz)	34.1					
	η_{pps}	1					
	$I_{pa,\alpha}$ at $z_{pii,\alpha}$ (W/cm^2)	240					
	$I_{spta,\alpha}$ at $z_{pii,\alpha}$ or $z_{sii,\alpha}$ (mW/cm^2)	26.5					
	I_{spta} at z_{pii} or z_{sii} (mW/cm^2)	36.2					
	p_r at z_{pii} (MPa)	2.63					
Operating controls	Exam type	Crd					Crd
	Optimization	Gen					Pen
	Depth (cm)	9.0					35
	MB/THI	Off/on					Off/on
	Sector size	Full					Narrow

(a) This index is not required for this operating mode; value is <1.

(b) This transducer is not intended for transcranial or neonatal cephalic uses.

No data are reported for this operating condition since the global maximum index value is not reported for the reason listed. (Reference global maximum index value line.)

— Data are not applicable for this transducer/mode.

Table 10-60: Transducer model: P2 1xp Operating mode: 2D + M Mode

Index label		MI	TIS		TIB		TIC
			At surface	Below surface	At surface	Below surface	At surface
Maximum index value		1.5	(a)		1.2		1.9
Index component value			#	#	0.6	1.2	
Acoustic parameters	$p_{r,\alpha}$ at z_{MI} (MPa)	1.97					
	P (mW)		#		115.8		133.3
	P_{1x1} (mW)		#		61.4		
	z_s (cm)			#			
	z_b (cm)					5.10	
	z_{MI} (cm)	4.1					
	$z_{pii,\alpha}$ (cm)	4.1					
	f_{awf} (MHz)	1.85	#		1.99		2.26
Other information	pr (Hz)	400					
	srr (Hz)	26.67					
	η_{pps}	1					
	$I_{pa,\alpha}$ at $z_{pii,\alpha}$ (W/cm^2)	228					
	$I_{spta,\alpha}$ at $z_{pii,\alpha}$ or $z_{sii,\alpha}$ (mW/cm^2)	103.2					
	I_{spta} at z_{pii} or z_{sii} (mW/cm^2)	174.0					
p_r at z_{pii} (MPa)	2.56						
Operating controls	Exam type	Crđ			Ob		Ob
	Optimization	Gen			Gen		Pen
	Depth (cm)	9.0			13		5.0
	THI	On			On		Off

(a) This index is not required for this operating mode; value is < 1.

(b) This transducer is not intended for transcranial or neonatal cephalic uses.

No data are reported for this operating condition since the global maximum index value is not reported for the reason listed. (Reference global maximum index value line.)

— Data are not applicable for this transducer/mode.

Table 10-61: Transducer model: P2 1xp Operating mode: Color/CPD

Index label		MI	TIS		TIB		TIC
			At surface	Below surface	At surface	Below surface	At surface
Maximum index value		1.5	1.4		1.4		2.8
Index component value			1.4	1.4	1.4	1.4	
Acoustic parameters	$p_{r,\alpha}$ at z_{MI} (MPa)	2.02					
	P (mW)		150.9		150.9		150.9
	$P_{1 \times 1}$ (mW)		141.3		141.3		
	z_s (cm)			—			
	z_b (cm)					—	
	z_{MI} (cm)	4.1					
	$z_{pii,\alpha}$ (cm)	4.1					
	f_{awf} (MHz)	1.85	2.03		2.03		2.03
Other information	pr_r (Hz)	800					
	srr (Hz)	12.1					
	n_{pps}	1					
	$I_{pa,\alpha}$ at $z_{pii,\alpha}$ (W/cm ²)	240					
	$I_{spta,\alpha}$ at $z_{pii,\alpha}$ or $z_{sij,\alpha}$ (mW/cm ²)	7.1					
	I_{spta} at z_{pii} or z_{sij} (mW/cm ²)	9.6					
	p_r at z_{pii} (MPa)	2.63					
Operating controls	Exam type	Crd	Abd		Abd		Abd
	Mode	Color	Color		Color		Color
	2D optimization/THI/depth (cm)	Gen/on/9.0	Gen/off/5.0		Gen/off/5.0		Gen/off/5.0
	Color optimization/PRF (Hz)	Low/880	High/2500		High/2500		High/2500
	Color box position/size	Top/short and wide	Top/default		Top/default		Top/default

(a) This index is not required for this operating mode; value is <1.

(b) This transducer is not intended for transcranial or neonatal cephalic uses.

No data are reported for this operating condition since the global maximum index value is not reported for the reason listed. (Reference global maximum index value line.)

— Data are not applicable for this transducer/mode.

Table 10-62: Transducer model: P2 1xp Operating mode: PW Doppler

Index label		MI	TIS		TIB		TIC
			At surface	Below surface	At surface	Below surface	At surface
Maximum index value		1.5	1.3		3.7		2.8
Index component value			0.7	1.3	0.7	3.7	
Acoustic parameters	$p_{r,\alpha}$ at z_{MI} (MPa)	2.15					
	P (mW)		204.3		204.3		82.3
	P_{1x1} (mW)		74.9		74.9		
	z_s (cm)		3.1				
	z_b (cm)				3.90		
	z_{MI} (cm)	1.4					
	$z_{pii,\alpha}$ (cm)	1.4					
	f_{awf} (MHz)	2.07	2.09		2.09		2.08
Other information	pr (Hz)	1562					
	srr (Hz)	—					
	n_{pps}	1					
	$I_{pa,\alpha}$ at $z_{pii,\alpha}$ (W/cm ²)	184					
	$I_{spta,\alpha}$ at $z_{pii,\alpha}$ or $z_{sii,\alpha}$ (mW/cm ²)	343.6					
	I_{spta} at z_{pii} or z_{sii} (mW/cm ²)	421.7					
	p_r at z_{pii} (MPa)	2.37					
Operating controls	Exam type	Abd	Crd		Abd		Abd
	Sample volume size (mm)	0	14		14		7
	Sample volume position	Zone 1 (2.3 cm)	Zone 8 (14 cm)		Zone 8 (14 cm)		Zone 0 (1.3 cm)
	PRF (Hz)	1562	1562		1562		1953
	TDI	N/A	Off		N/A		N/A

(a) This index is not required for this operating mode; value is <1.

(b) This transducer is not intended for transcranial or neonatal cephalic uses.

No data are reported for this operating condition since the global maximum index value is not reported for the reason listed. (Reference global maximum index value line.)

— Data are not applicable for this transducer/mode.

Table 10-63: Transducer model: P2 1xp Operating mode: CW Doppler

Index label		MI	TIS		TIB		TIC
			At surface	Below surface	At surface	Below surface	At surface
Maximum index value		(a)	1.1		4.0		2.6
Index component value			1.1	1.0	1.0	4.0	
Acoustic parameters	$p_{r,\alpha}$ at z_{MI} (MPa)	#					
	P (mW)		113.2		110.9		113.2
	P_{1x1} (mW)		113.2		100.2		
	z_s (cm)			0.92			
	z_b (cm)					1.25	
	z_{MI} (cm)	#					
	$z_{pii,\alpha}$ (cm)	#					
	f_{awf} (MHz)	#	2.00		2.00		2.00
Other information	pr (Hz)	#					
	srr (Hz)	#					
	η_{pps}	#					
	$I_{pa,\alpha}$ at $z_{pii,\alpha}$ (W/cm^2)	#					
	$I_{spta,\alpha}$ at $z_{pii,\alpha}$ or $z_{sii,\alpha}$ (mW/cm^2)	#					
	I_{spta} at z_{pii} or z_{sii} (mW/cm^2)	#					
	p_r at z_{pii} (MPa)	#					
Operating controls	Exam type		Crd		Crd		Crd
	Sample volume position		Zone 0 (1.3)		Zone 1 (2.3)		Zone 0 (1.3)

(a) This index is not required for this operating mode; value is <1.

(b) This transducer is not intended for transcranial or neonatal cephalic uses.

No data are reported for this operating condition since the global maximum index value is not reported for the reason listed. (Reference global maximum index value line.)

— Data are not applicable for this transducer/mode.

Table 10-64: Transducer model: P2 1xp (Orbital) Operating mode: 2D

Index label		MI	TIS		TIB		TIC
			At surface	Below surface	At surface	Below surface	At surface
Maximum index value		0.19	0.04		0.04		(b)
Index component value			0.04	0.04	0.04	0.04	
Acoustic parameters	$p_{r,\alpha}$ at z_{MI} (MPa)	0.28					
	P (mW)		6.8		6.8		#
	P_{1x1} (mW)		3.9		3.9		
	z_s (cm)			—			
	z_b (cm)					—	
	z_{MI} (cm)	3.8					
	$z_{pii,\alpha}$ (cm)	3.8					
	f_{awf} (MHz)	2.18	2.19		2.19		#
Other information	pr (Hz)	5000					
	srr (Hz)	38.8					
	η_{pps}	1					
	$I_{pa,\alpha}$ at $z_{pii,\alpha}$ (W/cm^2)	4.67					
	$I_{spta,\alpha}$ at $z_{pii,\alpha}$ or $z_{sii,\alpha}$ (mW/cm^2)	0.56					
	I_{spta} at z_{pii} or z_{sii} (mW/cm^2)	0.72					
	p_r at z_{pii} (MPa)	0.37					
Operating controls	Exam type	Orb	Orb		Orb		
	Optimization	Gen	Gen		Gen		
	Depth (cm)	5.0	27		27		

(a) This index is not required for this operating mode; value is <1.

(b) This transducer is not intended for transcranial or neonatal cephalic uses.

No data are reported for this operating condition since the global maximum index value is not reported for the reason listed. (Reference global maximum index value line.)

— Data are not applicable for this transducer/mode.

Table 10-65: Transducer model: P21xp (Orbital) Operating mode: 2D + M Mode

Index label		MI	TIS		TIB		TIC
			At surface	Below surface	At surface	Below surface	At surface
Maximum index value		0.19	0.04		0.05		(b)
Index component value			0.04	0.04	0.04	0.05	
Acoustic parameters	$p_{r,\alpha}$ at z_{MI} (MPa)	0.28					
	P (mW)		6.4		6.4		#
	P_{1x1} (mW)		3.4		3.4		
	z_s (cm)			3.5			
	z_b (cm)					4.30	
	z_{MI} (cm)	3.78					
	$z_{pii,\alpha}$ (cm)	3.78					
f_{awf} (MHz)	2.18	2.19		2.19		#	
Other information	pr (Hz)	400					
	srr (Hz)	33.3					
	η_{pps}	1					
	$I_{pa,\alpha}$ at $z_{pii,\alpha}$ (W/cm^2)	4.7					
	$I_{spta,\alpha}$ at $z_{pii,\alpha}$ or $z_{sii,\alpha}$ (mW/cm^2)	1.0					
	I_{spta} at z_{pii} or z_{sii} (mW/cm^2)	1.9					
p_r at z_{pii} (MPa)	0.37						
Operating controls	Exam type	Orb	Orb		Orb		
	Optimization	Gen	Gen		Gen		
	Depth (cm)	2.0	27		27		

(a) This index is not required for this operating mode; value is <1.

(b) This transducer is not intended for transcranial or neonatal cephalic uses.

No data are reported for this operating condition since the global maximum index value is not reported for the reason listed. (Reference global maximum index value line.)

— Data are not applicable for this transducer/mode.

Table 10-66: Transducer model: P2 1xp (Orbital) Operating mode: Color/CPD

Index label		MI	TIS		TIB		TIC
			At surface	Below surface	At surface	Below surface	At surface
Maximum index value		0.19	0.05		0.05		(b)
Index component value			0.05	0.05	0.05	0.05	
Acoustic parameters	$p_{r,\alpha}$ at z_{MI} (MPa)	0.27					
	P (mW)		9.2		9.2		#
	P_{1x1} (mW)		5.0		5.0		
	z_s (cm)			—			
	z_b (cm)					—	
	z_{MI} (cm)	1.39					
	$z_{pii,\alpha}$ (cm)	1.39					
	f_{awf} (MHz)	2.03	2.03		2.03		#
Other information	pr (Hz)	5179					
	srr (Hz)	17.6					
	n_{pps}	16					
	$I_{pa,\alpha}$ at $z_{pii,\alpha}$ (W/cm ²)	2.4					
	$I_{spta,\alpha}$ at $z_{pii,\alpha}$ or $z_{sij,\alpha}$ (mW/cm ²)	3.4					
	I_{spta} at z_{pii} or z_{sij} (mW/cm ²)	3.7					
	p_r at z_{pii} (MPa)	0.30					
Operating controls	Exam type	Orb	Orb		Orb		
	Mode	Color	Color		Color		
	2D optimization/depth (cm)	Gen/5	Gen/15		Gen/15		
	Color optimization/PRF (Hz)	Low/1096	Low/1453		Low/1453		
	Color box position/size	Default/default	Bottom/default		Bottom/default		

(a) This index is not required for this operating mode; value is <1.

(b) This transducer is not intended for transcranial or neonatal cephalic uses.

No data are reported for this operating condition since the global maximum index value is not reported for the reason listed. (Reference global maximum index value line.)

— Data are not applicable for this transducer/mode.

Table 10-67: Transducer model: P2 1xp (Orbital) Operating mode: PW Doppler

Index label		MI	TIS		TIB		TIC
			At surface	Below surface	At surface	Below surface	At surface
Maximum index value		0.20	0.22		0.53		(b)
Index component value			0.13	0.22	0.13	0.53	
Acoustic parameters	$p_{r,\alpha}$ at z_{MI} (MPa)	0.29					
	P (mW)		35.9		35.9		#
	P_{1x1} (mW)		13.2		13.2		
	z_s (cm)		3.5				
	z_b (cm)					4.30	
	z_{MI} (cm)	3.9					
	$z_{pii,\alpha}$ (cm)	3.9					
	f_{awf} (MHz)	2.09	2.09		2.09		#
Other information	pr (Hz)	1562					
	srr (Hz)	—					
	η_{pps}	1					
	$I_{pa,\alpha}$ at $z_{pii,\alpha}$ (W/cm ²)	3.25					
	$I_{spta,\alpha}$ at $z_{pii,\alpha}$ or $z_{sii,\alpha}$ (mW/cm ²)	29.7					
	I_{spta} at z_{pii} or z_{sii} (mW/cm ²)	93.2					
	p_r at z_{pii} (MPa)	0.383					
Operating controls	Exam type	Orb	Orb		Orb		
	Sample volume size (mm)	5	9		9		
	Sample volume position	Zone 9 (16.8 cm)	Zone 13 (27.3 cm)		Zone 13 (27.3 cm)		
	PRF (Hz)	1562	1562		1562		

(a) This index is not required for this operating mode; value is <1.

(b) This transducer is not intended for transcranial or neonatal cephalic uses.

No data are reported for this operating condition since the global maximum index value is not reported for the reason listed. (Reference global maximum index value line.)

— Data are not applicable for this transducer/mode.

Table 10-68: Transducer model: rP19xp Operating mode: 2D

Index label		MI	TIS		TIB		TIC
			At surface	Below surface	At surface	Below surface	At surface
Maximum index value		1.5	1.2		1.2		2.9
Index component value			1.2	1.2	1.2	1.2	
Acoustic parameters	$p_{r,\alpha}$ at z_{MI} (MPa)	1.95					
	P (mW)		184.8		184.8		190.8
	P_{1x1} (mW)		120.0		120.0		
	z_s (cm)			—			
	z_b (cm)					—	
	z_{MI} (cm)	2.6					
	$z_{pii,\alpha}$ (cm)	2.6					
	f_{awf} (MHz)	1.72	2.02		2.02		1.80
Other information	pr (Hz)	2933					
	srr (Hz)	34.1					
	η_{pps}	1					
	$I_{pa,\alpha}$ at $z_{pii,\alpha}$ (W/cm^2)	225					
	$I_{spta,\alpha}$ at $z_{pii,\alpha}$ or $z_{sii,\alpha}$ (mW/cm^2)	68.5					
	I_{spta} at z_{pii} or z_{sii} (mW/cm^2)	73.5					
	p_r at z_{pii} (MPa)	2.3					
Operating controls	Exam type	Crđ	Abđ		Abđ		Abđ
	Optimization	Gen	Pen		Pen		Gen
	Depth (cm)	7	5		5		5
	THI	On	Off		Off		On
	Sector width	Full	N/A		N/A		N/A

(a) This index is not required for this operating mode; value is <1.

(b) This transducer is not intended for transcranial or neonatal cephalic uses.

No data are reported for this operating condition since the global maximum index value is not reported for the reason listed. (Reference global maximum index value line.)

— Data are not applicable for this transducer/mode.

Table 10-69: Transducer model: rP19xp Operating mode: 2D + M Mode

Index label		MI	TIS		TIB		TIC
			At surface	Below surface	At surface	Below surface	At surface
Maximum index value		1.5	1.1		1.6		3.0
Index component value			1.1	1.1	0.9	1.6	
Acoustic parameters	$p_{r,\alpha}$ at z_{MI} (MPa)	1.95					
	P (mW)		171.5		162.1		180.5
	P_{1x1} (mW)		114.8		109.9		
	z_s (cm)			1.5			
	z_b (cm)					3.02	
	z_{MI} (cm)	2.6					
	$z_{pii,\alpha}$ (cm)	2.6					
f_{awf} (MHz)	1.72		2.09		1.73		1.75
Other information	pr (Hz)	400					
	srr (Hz)	26.7					
	η_{pps}	1					
	$I_{pa,\alpha}$ at $z_{pii,\alpha}$ (W/cm^2)	225					
	$I_{spta,\alpha}$ at $z_{pii,\alpha}$ or $z_{sii,\alpha}$ (mW/cm^2)	102.0					
	I_{spta} at z_{pii} or z_{sii} (mW/cm^2)	142.8					
p_r at z_{pii} (MPa)	2.3						
Operating controls	Exam type	Crđ	Abđ		Crđ		Abđ
	Optimization	Gen	Pen		Gen		Gen
	Depth (cm)	7	7		13		5
	THI	On	Off		On		On

(a) This index is not required for this operating mode; value is <1.

(b) This transducer is not intended for transcranial or neonatal cephalic uses.

No data are reported for this operating condition since the global maximum index value is not reported for the reason listed. (Reference global maximum index value line.)

— Data are not applicable for this transducer/mode.

Table 10-70: Transducer model: rP19xp Operating mode: Color/CPD

Index label		MI	TIS		TIB		TIC
			At surface	Below surface	At surface	Below surface	At surface
Maximum index value		1.5	1.6		1.6		3.8
Index component value			1.6	1.6	1.6	1.6	
Acoustic parameters	$p_{r,\alpha}$ at z_{MI} (MPa)	2.15					
	P (mW)		158.4		158.4		174.1
	$P_{1 \times 1}$ (mW)		134.3		134.3		
	z_s (cm)			—			
	z_b (cm)					—	
	z_{MI} (cm)	4.3					
	$z_{pii,\alpha}$ (cm)	4.3					
	f_{awf} (MHz)	2.05	2.60		2.60		2.09
Other information	prf (Hz)	1526					
	srr (Hz)	15.4					
	n_{pps}	14					
	$I_{pa,\alpha}$ at $z_{pii,\alpha}$ (W/cm ²)	355					
	$I_{spta,\alpha}$ at $z_{pii,\alpha}$ or $z_{sij,\alpha}$ (mW/cm ²)	287.4					
	I_{spta} at z_{pii} or z_{sij} (mW/cm ²)	362.4					
	p_r at z_{pii} (MPa)	2.91					
Operating controls	Exam type	Lung	Ob		Ob		Crd
	Mode	CVD	CVD		CVD		CVD
	2D optimization/depth (cm)	Gen/13	Gen/5		Gen/5		Pen/5
	Sector width/THI	N/A	N/A/off		N/A/off		Med/on
	Color optimization/PRF (Hz)	Low/273	High/2841		High/2841		High/3571
	Color box position/size	Default/narrow	Bottom/small		Bottom/small		Default/narrow

(a) This index is not required for this operating mode; value is <1.

(b) This transducer is not intended for transcranial or neonatal cephalic uses.

No data are reported for this operating condition since the global maximum index value is not reported for the reason listed. (Reference global maximum index value line.)

— Data are not applicable for this transducer/mode.

Table 10-71: Transducer model: rP19xp Operating mode: PW Doppler

Index label		MI	TIS		TIB		TIC
			At surface	Below surface	At surface	Below surface	At surface
Maximum index value		1.5	1.6		4.0		3.2
Index component value			1.6	1.1	0.9	4.0	
Acoustic parameters	$p_{r,\alpha}$ at z_{MI} (MPa)	2.17					
	P (mW)		92.6		192.5		211.8
	P_{1x1} (mW)		92.6		87.2		
	z_s (cm)		1.59				
	z_b (cm)					5.10	
	z_{MI} (cm)	0.5					
	$z_{pii,\alpha}$ (cm)	0.5					
	f_{awf} (MHz)	2.08	3.67		2.06		2.04
Other information	pr_r (Hz)	1562					
	srr (Hz)	—					
	η_{pps}	1					
	$I_{pa,\alpha}$ at $z_{pii,\alpha}$ (W/cm ²)	156					
	$I_{spta,\alpha}$ at $z_{pii,\alpha}$ or $z_{sii,\alpha}$ (mW/cm ²)	278.0					
	I_{spta} at z_{pii} or z_{sii} (mW/cm ²)	299.9					
	p_r at z_{pii} (MPa)	2.24					
Operating controls	Exam type	Abd	Crd		Abd		Abd
	Sample volume size (mm)	1	2		1		1
	Sample volume position	Zone 0 (13 mm)	Zone 2 (34 mm)		Zone 6 (96 mm)		Zone 7 (115 mm)
	PRF (Hz)	1562	1302		1562		1562
	TDI	Off	On		Off		Off

(a) This index is not required for this operating mode; value is <1.

(b) This transducer is not intended for transcranial or neonatal cephalic uses.

No data are reported for this operating condition since the global maximum index value is not reported for the reason listed. (Reference global maximum index value line.)

— Data are not applicable for this transducer/mode.

Table 10–72: Transducer model: rP19xp Operating mode: CW Doppler

Index label		MI	TIS		TIB		TIC
			At surface	Below surface	At surface	Below surface	At surface
Maximum index value		(a)	1.2		4.0		3.1
Index component value			1.2	1.1	1.2	4.0	
Acoustic parameters	$p_{r,\alpha}$ at z_{MI} (MPa)	#					
	P (mW)		135.2		134.7		125.7
	$P_{1 \times 1}$ (mW)		130.6		130.1		
	z_s (cm)			1.15			
	z_b (cm)					3.4	
	z_{MI} (cm)	#					
	$z_{pii,\alpha}$ (cm)	#					
	f_{awf} (MHz)	#	2.00		2.00		2.00
Other information	prr (Hz)	#					
	srr (Hz)	#					
	n_{pps}	#					
	$I_{pa,\alpha}$ at $z_{pii,\alpha}$ (W/cm^2)	#					
	$I_{spta,\alpha}$ at $z_{pii,\alpha}$ or $z_{sii,\alpha}$ (mW/cm^2)	#					
	I_{spta} at z_{pii} or z_{sii} (mW/cm^2)	#					
	p_r at z_{pii} (MPa)	#					
Operating controls	Exam type		Crd		Ven		Crd
	Sample volume position		Zone 11 (220 mm)		Zone 10 (189 mm)		Zone 0 (13 mm)

(a) This index is not required for this operating mode; value is <1.
 (b) This transducer is not intended for transcranial or neonatal cephalic uses.
 # No data are reported for this operating condition since the global maximum index value is not reported for the reason listed. (Reference global maximum index value line.)
 — Data are not applicable for this transducer/mode.

Table 10-73: Transducer model: rP19xp (Orbital) Operating mode: 2D

Index label		MI	TIS		TIB		TIC
			At surface	Below surface	At surface	Below surface	At surface
Maximum index value		0.17	0.026		0.026		0.057
Index component value			0.026	0.026	0.026	0.026	
Acoustic parameters	$p_{r,\alpha}$ at z_{MI} (MPa)	0.26					
	P (mW)		3.88		3.88		3.88
	P_{1x1} (mW)		2.35		2.35		
	z_s (cm)			—			
	z_b (cm)					—	
	z_{MI} (cm)	4.0					
	$z_{pii,\alpha}$ (cm)	4.0					
	f_{awf} (MHz)	2.34	2.33		2.33		2.34
Other information	pr (Hz)	2317					
	srr (Hz)	18.0					
	η_{pps}	1					
	$I_{pa,\alpha}$ at $z_{pii,\alpha}$ (W/cm^2)	3.41					
	$I_{spta,\alpha}$ at $z_{pii,\alpha}$ or $z_{sii,\alpha}$ (mW/cm^2)	1.2					
	I_{spta} at z_{pii} or z_{sii} (mW/cm^2)	1.5					
	p_r at z_{pii} (MPa)	0.45					
Operating controls	Exam type	Orb	Orb		Orb		Orb
	Optimization	Gen	Gen		Gen		Gen
	Depth (cm)	31	31		31		31
	THI	Off	Off		Off		Off

(a) This index is not required for this operating mode; value is <1.

(b) This transducer is not intended for transcranial or neonatal cephalic uses.

No data are reported for this operating condition since the global maximum index value is not reported for the reason listed. (Reference global maximum index value line.)

— Data are not applicable for this transducer/mode.

Table 10-74: Transducer model: rP19xp (Orbital) Operating mode: 2D + M Mode

Index label		MI	TIS		TIB		TIC
			At surface	Below surface	At surface	Below surface	At surface
Maximum index value		0.17	0.024		0.030		0.055
Index component value			0.024	0.005	0.022	0.030	
Acoustic parameters	$p_{r,\alpha}$ at z_{MI} (MPa)	0.26					
	P (mW)		3.68		3.52		3.68
	P_{1x1} (mW)		2.13		2.01		
	z_s (cm)			2.80			
	z_b (cm)					3.80	
	z_{MI} (cm)	4.0					
	$z_{pii,\alpha}$ (cm)	4.0					
	f_{awf} (MHz)	2.34	2.37		2.34		2.37
Other information	pr (Hz)	1600					
	srr (Hz)	12.4					
	η_{pps}	1					
	$I_{pa,\alpha}$ at $z_{pii,\alpha}$ (W/cm ²)	3.41					
	$I_{spta,\alpha}$ at $z_{pii,\alpha}$ or $z_{sii,\alpha}$ (mW/cm ²)	0.85					
	I_{spta} at z_{pii} or z_{sii} (mW/cm ²)	1.03					
p_r at z_{pii} (MPa)	0.45						
Operating controls	Exam type	Orb	Orb		Orb		
	Optimization	Gen	Gen		Gen		
	Depth (cm)	31	25		31		
	THI	Off	Off		Off		

(a) This index is not required for this operating mode; value is < 1.

(b) This transducer is not intended for transcranial or neonatal cephalic uses.

No data are reported for this operating condition since the global maximum index value is not reported for the reason listed. (Reference global maximum index value line.)

— Data are not applicable for this transducer/mode.

Table 10-75: Transducer model: rP19xp (Orbital) Operating mode: Color/CPD

Index label		MI	TIS		TIB		TIC
			At surface	Below surface	At surface	Below surface	At surface
Maximum index value		0.20	0.055		0.055		0.12
Index component value			0.055	0.055	0.055	0.055	
Acoustic parameters	$p_{r,\alpha}$ at z_{MI} (MPa)	0.28					
	P (mW)		5.77		5.77		5.77
	$P_{1 \times 1}$ (mW)		5.55		5.55		
	z_s (cm)			—			
	z_b (cm)					—	
	z_{MI} (cm)	0.4					
	$z_{pii,\alpha}$ (cm)	0.4					
	f_{awf} (MHz)	2.07	2.07		2.07		2.07
Other information	prf (Hz)	6301					
	srf (Hz)	20.5					
	n_{pps}	14					
	$I_{pa,\alpha}$ at $z_{pii,\alpha}$ (W/cm ²)	2.58					
	$I_{spta,\alpha}$ at $z_{pii,\alpha}$ or $z_{sij,\alpha}$ (mW/cm ²)	3.9					
	I_{spta} at z_{pii} or z_{sij} (mW/cm ²)	4.1					
	p_r at z_{pii} (MPa)	0.29					
Operating controls	Exam type	Orb	Orb		Orb		Orb
	Mode	CVD	CVD		CVD		CVD
	2D optimization/depth (cm)	Gen/5	Gen/5		Gen/5		Gen/5
	Color optimization/PRF (Hz)	Med/2778	Med/2778		Med/2778		Med/2778
	Color box position/size	Default/top	Default/top		Default/top		Default/top

(a) This index is not required for this operating mode; value is <1.

(b) This transducer is not intended for transcranial or neonatal cephalic uses.

No data are reported for this operating condition since the global maximum index value is not reported for the reason listed. (Reference global maximum index value line.)

— Data are not applicable for this transducer/mode.

Table 10-76: Transducer model: rP19xp (Orbital) Operating mode: PW Doppler

Index label		MI	TIS		TIB		TIC
			At surface	Below surface	At surface	Below surface	At surface
Maximum index value		0.19	0.22		0.56		0.51
Index component value			0.15	0.22	0.15	0.56	
Acoustic parameters	$p_{r,\alpha}$ at z_{MI} (MPa)	0.28					
	P (mW)		33.8		33.8		34.4
	P_{1x1} (mW)		15.3		15.3		
	z_s (cm)			3.0			
	z_b (cm)					3.8	
	z_{MI} (cm)	0.8					
	$z_{pii,\alpha}$ (cm)	0.8					
	f_{awf} (MHz)	2.11	2.09		2.09		2.09
Other information	pr (Hz)	3906					
	srr (Hz)	—					
	n_{pps}	1					
	$I_{pa,\alpha}$ at $z_{pii,\alpha}$ (W/cm ²)	2.43					
	$I_{spta,\alpha}$ at $z_{pii,\alpha}$ or $z_{sii,\alpha}$ (mW/cm ²)	34.9					
	I_{spta} at z_{pii} or z_{sii} (mW/cm ²)	38.9					
p_r at z_{pii} (MPa)	0.29						
Operating controls	Exam type	Orb	Orb		Orb		Orb
	Sample volume size (mm)	3	9		9		7
	Sample volume position	Zone 1 (23 mm)	Zone 11 (220 mm)		Zone 11 (220 mm)		Zone 13 (273 mm)
	PRF (Hz)	3906	2604		2604		1953

(a) This index is not required for this operating mode; value is <1.

(b) This transducer is not intended for transcranial or neonatal cephalic uses.

No data are reported for this operating condition since the global maximum index value is not reported for the reason listed. (Reference global maximum index value line.)

— Data are not applicable for this transducer/mode.

Table 10-77: Transducer model: TEEExp Operating mode: 2D

Index label		MI	TIS		TIB		TIC
			At surface	Below surface	At surface	Below surface	At surface
Maximum index value		1.2	(a)		(a)		(b)
Index component value			#	#	#	#	
Acoustic parameters	$p_{r,\alpha}$ at z_{MI} (MPa)	2.60					
	P (mW)		#		#		#
	P_{1x1} (mW)		#		#		
	z_s (cm)			—			
	z_b (cm)					—	
	z_{MI} (cm)	1.7					
	$z_{pii,\alpha}$ (cm)	1.7					
	f_{awf} (MHz)	4.60	#		#		#
Other information	pr_r (Hz)	1750					
	srr (Hz)	50.0					
	η_{pps}	1					
	$I_{pa,\alpha}$ at $z_{pii,\alpha}$ (W/cm^2)	366					
	$I_{spta,\alpha}$ at $z_{pii,\alpha}$ or $z_{sii,\alpha}$ (mW/cm^2)	26.3					
	I_{spta} at z_{pii} or z_{sii} (mW/cm^2)	33.5					
	p_r at z_{pii} (MPa)	3.38					
Operating controls	Exam type	Crd					
	Optimization	Pen					
	Depth (cm)	4.0					
	Sector width	Narrow					

(a) This index is not required for this operating mode; value is <1.

(b) This transducer is not intended for transcranial or neonatal cephalic uses.

No data are reported for this operating condition since the global maximum index value is not reported for the reason listed. (Reference global maximum index value line.)

— Data are not applicable for this transducer/mode.

Table 10-78: Transducer model: TEEp Operating mode: 2D + M Mode

Index label		MI	TIS		TIB		TIC
			At surface	Below surface	At surface	Below surface	At surface
Maximum index value		1.0	(a)		(a)		(b)
Index component value			#	#	#	#	
Acoustic parameters	$p_{r,\alpha}$ at z_{MI} (MPa)	2.09					
	P (mW)		#		#		#
	P_{1x1} (mW)		#		#		
	z_s (cm)			#			
	z_b (cm)					#	
	z_{MI} (cm)	1.75					
	$z_{pii,\alpha}$ (cm)	1.75					
	f_{awf} (MHz)	4.60	#		#		#
Other information	pr (Hz)	400					
	srr (Hz)	30.8					
	η_{pps}	1					
	$I_{pa,\alpha}$ at $z_{pii,\alpha}$ (W/cm^2)	244					
	$I_{spta,\alpha}$ at $z_{pii,\alpha}$ or $z_{sii,\alpha}$ (mW/cm^2)	31.5					
	I_{spta} at z_{pii} or z_{sii} (mW/cm^2)	54.9					
	p_r at z_{pii} (MPa)	2.74					
Operating controls	Exam type	Crd					
	Optimization	Pen					
	Depth (cm)	4.0					

(a) This index is not required for this operating mode; value is <1.

(b) This transducer is not intended for transcranial or neonatal cephalic uses.

No data are reported for this operating condition since the global maximum index value is not reported for the reason listed. (Reference global maximum index value line.)

— Data are not applicable for this transducer/mode.

Table 10-79: Transducer model: TEEExp Operating mode: PW Doppler

Index label		MI	TIS		TIB		TIC
			At surface	Below surface	At surface	Below surface	At surface
Maximum index value		1.3	(a)		1.9		(b)
Index component value			#	#	0.6	1.9	
Acoustic parameters	$p_{r,\alpha}$ at z_{MI} (MPa)	2.64					
	P (mW)		#		32.8		#
	P_{1x1} (mW)		#		32.8		
	z_s (cm)			#			
	z_b (cm)					0.60	
	z_{MI} (cm)	0.6					
	$z_{pii,\alpha}$ (cm)	0.6					
f_{awf} (MHz)	4.01		#		4.01		#
Other information	prr (Hz)	1008					
	srr (Hz)	—					
	n_{pps}	1					
	$I_{pa,\alpha}$ at $z_{pii,\alpha}$ (W/cm^2)	289					
	$I_{spta,\alpha}$ at $z_{pii,\alpha}$ or $z_{sii,\alpha}$ (mW/cm^2)	327.5					
	I_{spta} at z_{pii} or z_{sii} (mW/cm^2)	386.0					
	p_r at z_{pii} (MPa)	2.86					
Operating controls	Exam type	Crd			Crd		
	Sample volume size (mm)	1			2		
	Sample volume position	Zone 1 (16 mm)			Zone 1 (16 mm)		
	PRF (Hz)	1008			1562		
	TDI	On			Off		

(a) This index is not required for this operating mode; value is <1.

(b) This transducer is not intended for transcranial or neonatal cephalic uses.

No data are reported for this operating condition since the global maximum index value is not reported for the reason listed. (Reference global maximum index value line.)

— Data are not applicable for this transducer/mode.

Table 10–80: Transducer model: TEEExp Operating mode: CW Doppler

Index label		MI	TIS		TIB		TIC
			At surface	Below surface	At surface	Below surface	At surface
Maximum index value		(a)	(a)		1.3		(b)
Index component value			#	#	0.5	1.3	
Acoustic parameters	$p_{r,\alpha}$ at z_{MI} (MPa)	#					
	P (mW)		#		25.9		#
	$P_{1 \times 1}$ (mW)		#		25.9		
	z_s (cm)			#			
	z_b (cm)					0.90	
	z_{MI} (cm)	#					
	$z_{pii,\alpha}$ (cm)	#					
	f_{awf} (MHz)	#	#		4.00		#
Other information	pr (Hz)	#					
	srr (Hz)	#					
	η_{pps}	#					
	$I_{pa,\alpha}$ at $z_{pii,\alpha}$ (W/cm^2)	#					
	$I_{spta,\alpha}$ at $z_{pii,\alpha}$ or $z_{sii,\alpha}$ (mW/cm^2)	#					
	I_{spta} at z_{pii} or z_{sii} (mW/cm^2)	#					
	p_r at z_{pii} (MPa)	#					
Operating controls	Exam type				Crd		
	Sample volume position				Zone 5 (53 mm)		

(a) This index is not required for this operating mode; value is <1.

(b) This transducer is not intended for transcranial or neonatal cephalic uses.

No data are reported for this operating condition since the global maximum index value is not reported for the reason listed. (Reference global maximum index value line.)

— Data are not applicable for this transducer/mode.

Acoustic measurement precision and uncertainty

All table entries have been obtained at the same operating conditions that give rise to the maximum index value in the first column of the table. Measurement precision and uncertainty for power, pressure, intensity, and other quantities that are used to derive the values in the acoustic output table are shown in the table below. In accordance with Section 6.4 of the Output Display Standard, the following measurement precision and uncertainty values are determined by making repeat measurements and stating the standard deviation as a percentage.

Table 10-81: Acoustic Measurement Precision and Uncertainty

Quantity	Precision (% of standard deviation)	Uncertainty (95% confidence)
p_r	1.9%	$\pm 11.2\%$
$p_{r.3}$	1.9%	$\pm 12.2\%$
P	3.4%	$\pm 10\%$
f_{awf}	0.1%	$\pm 4.7\%$
pii	3.2%	+12.5 to -16.8%
pii.3	3.2%	+13.47 to -17.5%

Terminology in acoustic output tables

Table 10-82: Terms used in the acoustic output tables

Term	Definition
α	Attenuation coefficient used for derating. Equal to 0.3 dB/cm/MHz ² .
f_{awf}	Acoustic working frequency.
$I_{pa,\alpha}$	Attenuated pulse-average intensity.
I_{spta}	Spatial-peak temporal-average intensity.
$I_{spta,\alpha}$	Attenuated spatial-peak temporal-average intensity.
MI	Mechanical index.
P	Output power.
P_{1x1}	Bounded-square output power.
$p_{r,\alpha}$	Attenuated peak-rarefactional acoustic pressure.
p_r	Peak-rarefactional acoustic pressure.
p_{ii}	Pulse-intensity integral.
$p_{ii,\alpha}$	Attenuated pulse-intensity integral.
n_{pps}	Number of pulses per ultrasonic scan line.
prf	Pulse repetition rate.
srr	Scan repetition rate.
TI	Thermal index.
TIB	Bone thermal index.
TIC	Cranial-bone thermal index.
TIS	Soft-tissue thermal index.
z_b	Depth for TIB.
z_{MI}	Depth for mechanical index.
$z_{p_{ii}}$	Depth for peak pulse-intensity integral.
$z_{p_{ii,\alpha}}$	Depth for peak attenuated pulse-intensity integral.

Table 10-82: Terms used in the acoustic output tables

Term	Definition
z_{sij}	Depth for peak sum of pulse-intensity integrals.
$z_{sij,\alpha}$	Depth for peak sum of attenuated pulse-intensity integrals.
z_s	Depth for TIS.

IT Network

Functions

This device can be connected to an IT network to perform the following functions:

- ▶ Storing the examination data (static images, clips) acquired by this device in a Picture Archiving and Communication System (PACS) by DICOM communication.
- ▶ Querying examination orders from the Modality Worklist (MWL) server by DICOM communication and starting them.
- ▶ Setting the time of this device by interrogating the network time service.
- ▶ Communicating procedure status via the Modality Performed Procedure Step (MPPS) service.
- ▶ Requesting transfer of responsibility for image ownership to another system via the Storage Commitment service.

Network for connecting the device

To ensure safety, use an IT network that is isolated from the external environment by a firewall.

Specifications for the connection

Hardware specification

- ▶ 802.11 b/g/n
- ▶ Ethernet 10/100/1000 BASE-T using RJ45 port with patch cable

Security

- ▶ The port for DICOM communication (specified by the user in the system settings; typically port 104, 2762, or 11112) is used for outgoing communication to the network.

- ▶ Anti-virus software is not installed on this device.
- ▶ This device has a single configurable listening port for the purposes of DICOM Echo and Storage Commitment.

Data flow

DICOM

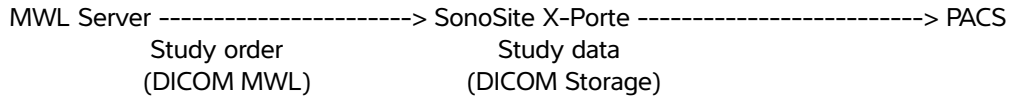

Please refer to the *SonoSite X-Porte DICOM Conformance Statement (D10711)* for details.

Caution

- 1 Connection of equipment to an IT network that includes other systems could result in previously unidentified risks to patients, operators or third parties. Before connecting the equipment to an uncontrolled IT Network, make sure that all potential risks resulting from such connections were identified and evaluated, and suitable countermeasures were put in place. IEC 80001-1:2010 provides guidance for addressing these risks.
- 2 When a setting of the IT network to which this device is connected has been changed, check that the change does not affect this device and take measures if necessary. Changes to the IT network include:
 - ▶ Changes in network configuration (IP address, router etc.)
 - ▶ Connection of additional items
 - ▶ Disconnection of items
 - ▶ Update of equipment
 - ▶ Upgrade of equipmentAny changes to the IT network could introduce new risks requiring additional evaluation to be performed as per item 1 above.

IT network failure recovery measures

Connection to an IT network may become, at times, unreliable, and this may lead to failure to perform the functions described in “**Functions**” on page 11-1. As a result, the following hazardous situations may occur:

Table 11-1: IT network failure recovery

Network failure	Impact on equipment	Hazard	SonoSite X-Porte countermeasures
IT network becomes unstable	Unable to transmit exam data to a PACS	Delay of diagnosis	SonoSite X-Porte has internal memory, and exam data is stored in it. After the IT network has returned to stable, the user can re-initiate the transfer of data.
	Delay of transmission to a PACS		
	Incorrect data transmitted to a PACS	Misdiagnosis	Integrity of the data is ensured by the TCP/IP and DICOM Protocols used by SonoSite X-Porte.
	Unable to get order data from an MWL server	Delay of exam	On SonoSite X-Porte, the user can initiate/ create a new study.
	Delay of getting order from an MWL server		
	Incorrect data from a MWL server	Incorrect exam	SonoSite X-Porte uses the TCP/IP and DICOM Protocols. Integrity of the data is ensured by them.
	Unable to get the time from a time server.	Incorrect exam data	SonoSite X-Porte has the capability of entering data and time manually.
	Incorrect time data		

Table 11-1: IT network failure recovery (continued)

Network failure	Impact on equipment	Hazard	SonoSite X-Porte countermeasures
Firewall has broken down	Attack via network	Manipulation of exam data	SonoSite X-Porte closes unnecessary network ports.
	Infection by computer virus	Leak of exam data	SonoSite X-Porte prevents a user from loading software and executing it.

Glossary

Terms

For ultrasound terms not included in this glossary, refer to *Recommended Ultrasound Terminology, Third Edition*, published in 2011 by the American Institute of Ultrasound in Medicine (AIUM).

as low as reasonably achievable (ALARA)	The guiding principle of ultrasound use, which states that you should keep patient exposure to ultrasound energy as low as reasonably achievable for diagnostic results.
curved array transducer	Identified by the letter C (curved or curvilinear) and a number (60). The number corresponds to the radius of curvature of the array expressed in millimeters. The transducer elements are electrically configured to control the characteristics and direction of the acoustic beam. For example, C60xp.
depth	Refers to the depth of the display. A constant speed of sound of 1538.5 meters/second is assumed in the calculation of echo position in the image.
in situ	In the natural or original position.
linear array transducer	Identified by the letter L (linear) and a number (38). The number corresponds to the length of the array expressed in millimeters. The transducer elements are electrically configured to control the characteristics and direction of the acoustic beam. For example, L38xp.
mechanical index (MI)	An indication of the likelihood of mechanical bioeffects occurring: the higher the MI, the greater the likelihood of mechanical bioeffects. See Chapter 10, “Acoustic output,” for a more complete description of MI.
MI/TI	Refer to <i>mechanical index (MI)</i> and <i>thermal index (TI)</i> .
phased array transducer	A transducer designed primarily for cardiac scanning. Forms a sector image by electronically steering the beam direction and focus. For example, P21xp.
skinline	A depth on the display that corresponds to the skin/transducer interface.
SonoMB technology	A subset of the 2D imaging mode in which the 2D image is enhanced by looking at a target from multiple angles and then merging or averaging the scanned data together to improve overall image quality and, in parallel, reducing noise and artifacts.
Tissue Doppler Imaging (TDI)	A pulsed wave Doppler technique used to detect myocardial motion.

thermal index (TI)	The ratio of total acoustic power to the acoustic power required to raise tissue temperature by 1°C under defined assumptions. See Chapter 10, “Acoustic output,” for a more complete description of TI.
TIB (bone thermal index)	A thermal index for applications in which the ultrasound beam passes through soft tissue and a focal region is in the immediate vicinity of bone.
TIC (cranial bone thermal index)	A thermal index for applications in which the ultrasound beam passes through bone near the beam entrance into the body.
TIS (soft tissue thermal index)	A thermal index related to soft tissues.
Tissue Harmonic Imaging (THI)	Transmits at one frequency and receives at a higher harmonic frequency to reduce noise and clutter and improve resolution.
transducer	A device that transforms one form of energy into another form of energy. Ultrasound transducers contain piezoelectric elements, which when excited electrically, emit acoustic energy. When the acoustic energy is transmitted into the body, it travels until it encounters an interface, or change in tissue properties. At the interface, an echo is formed that returns to the transducer, where this acoustic energy is transformed into electrical energy, processed, and displayed as anatomical information.
variance	Displays a variation in Color Doppler flow imaging within a given sample. Variance is mapped to the color green and is used to detect turbulence.

Abbreviations

Table A-1: Abbreviations in user interface

Abbreviation	Definition
A	“A” Wave Peak Velocity
A PG	“A” Wave Peak Pressure Gradient
A2Cd	Apical 2 Chamber diastolic
A2Cs	Apical 2 Chamber systolic
A4Cd	Apical 4 Chamber diastolic
A4Cs	Apical 4 Chamber systolic
AAA	Abdominal Aortic Aneurysm
AAo	Ascending Aorta

Table A-1: Abbreviations in user interface (continued)

Abbreviation	Definition
Abd	Abdomen
abs	Absolute value
AC	Abdominal Circumference
ACA	Anterior Cerebral Artery
ACC	Acceleration Index
ACoA	Anterior Communicating Artery
ACS	Aortic Valve Cusp Separation
Adur	“A” wave duration
AFI	Amniotic Fluid Index
AI	Aortic Insufficiency
AI PHT	Aortic Insufficiency Pressure Half Time
AL	Atlas Loop
Ann D	Annulus Diameter
ANT F	Anterior Far
ANT N	Anterior Near
Ao	Aorta
AoD	Aortic Root Diameter
Apical	Apical View
APTD	Anteroposterior Trunk Diameter
AT	Acceleration (Deceleration) Time
AUA	Average Ultrasound Age Calculated by averaging the individual ultrasound ages for the fetal biometry measurements performed during the exam. The measurements used to determine the AUA are based on the selected OB calculation authors.
AV	Aortic Valve
AV Area	Aortic Valve Area

Table A-1: Abbreviations in user interface (continued)

Abbreviation	Definition
AVA	Aortic Valve Area
BA	Basilar Artery
Bifur	Bifurcation
BP	Blood Pressure
BPD	Biparietal Diameter
BPM	Beats per Minute
Bre	Breast
BSA	Body Surface Area
CCA	Common Carotid Artery
CI	Cardiac Index
CM	Cisterna Magna
CO	Cardiac Output
CPD	Color Power Doppler
Crd	Cardiac
CRL	Crown Rump Length
CVD	Color Velocity Doppler
CW	Continuous Wave Doppler
CxLen	Cervix Length
D	Diameter
D Apical	Distance Apical
DCCA	Distal Common Carotid Artery
DECA	Distal External Carotid Artery
Decel	Deceleration time
DICA	Distal Internal Carotid Artery
Dist	Distal

Table A-1: Abbreviations in user interface (continued)

Abbreviation	Definition
dP:dT	Delta Pressure: Delta Time
E	"E" Wave Peak Velocity
E PG	"E" Wave Peak Pressure Gradient
E:A	E:A Ratio
E/e'	E velocity = Mitral Valve E velocity divided by the annular e' velocity
ECA	External Carotid Artery
ECG	Electrocardiogram
ECICA	Extracranial Internal Carotid Artery
ECVA	Extracranial Vertebral Artery
EDD	Estimated Date of Delivery
EDD by AUA	Estimated Date of Delivery by Average Ultrasound Age The estimated date of delivery calculated from the measurements performed during the exam.
EDD by LMP	Estimated Date of Delivery by Last Menstrual Period The due date calculated from the user-entered LMP.
EDV	End Diastolic Velocity
EF	Ejection Fraction
EF:SLOPE	E-F Slope
EFW	Estimated Fetal Weight Calculated from the measurements performed during the exam. The measurements used to determine EFW are defined by the currently selected EFW calculation author.
Endo	Endocardial
Epi	Epicardial
EPSS	"E" Point Septal Separation
Estab. DD	Established Due Date A user-entered due date based on previous exam data or other available information. The LMP is derived from the Established Due Date and is listed in the patient report as LMPd.

Table A-1: Abbreviations in user interface (continued)

Abbreviation	Definition
ET	Elapsed Time
FAC	Fractional Area Change
FH	Femoral Head
FHR	Fetal Heart Rate
FL	Femur Length
FM	Foramen Magnum (same as SO)
FS	Fractional Shortening
FTA	Fetal Trunk Area
GA	Gestational Age
GA by LMP	Gestational Age by Last Menstrual Period The fetal age calculated using the date of the Last Menstrual Period (LMP).
GA by LMPd	Gestational Age by derived Last Menstrual Period The fetal age calculated using the Last Menstrual Period (LMPd) derived from the Estab. DD.
Gate	Depth of Doppler Gate
GS	Gestational Sac
Gyn	Gynecology
HC	Head Circumference
HL	Humerus Length
HR	Heart Rate
ICA	Internal Carotid Artery
IMT	Intima Media Thickness
IVC	Inferior Vena Cava
IVRT	Iso Volumic Relaxation Time
IVS	Interventricular Septum
IVSd	Interventricular Septum Diastolic

Table A-1: Abbreviations in user interface (continued)

Abbreviation	Definition
IVSFT	Interventricular Septum Fractional Thickening
IVSs	Interventricular Septum Systolic
LA	Left Atrium
LA/Ao	Left Atrium/Aorta Ratio
LAT F	Lateral Far
LAT N	Lateral Near
Lat V	Lateral Ventricle
LMP	Last Menstrual Period
LMP	Last Menstrual Period The first day of the last menstrual period. Used to calculate gestational age and EDD.
LMPd	derived Last Menstrual Period Calculated from the user-entered Estab. DD.
LV	Left Ventricular
LV Area	Left Ventricular Area
LV mass	Left Ventricular mass
LV Volume	Left Ventricular Volume
LVd	Left Ventricular diastolic
LVD	Left Ventricular Dimension
LVDd	Left Ventricular Dimension Diastolic
LVDFS	Left Ventricular Dimension Fractional Shortening
LVDs	Left Ventricular Dimension Systolic
LVEDV	Left Ventricular End Diastolic Volume
LVESV	Left Ventricular End Systolic Volume
LVET	Left Ventricular Ejection Time
LVO	Left Ventricular Opacification
LVOT	Left Ventricular Outflow Tract

Table A-1: Abbreviations in user interface (continued)

Abbreviation	Definition
LVOT Area	Left Ventricular Outflow Tract Area
LVOT D	Left Ventricular Outflow Tract Diameter
LVOT VTI	Left Ventricular Outflow Tract Velocity Time Integral
LVPW	Left Ventricular Posterior Wall
LVPWd	Left Ventricular Posterior Wall Diastolic
LVPWFT	Left Ventricular Posterior Wall Fractional Thickening
LVPWs	Left Ventricular Posterior Wall Systolic
LVs	Left Ventricular systolic
MAPSE	Mitral Annular Plane Systolic Excursion: M Mode distance measurement of systolic excursion of the left ventricle
MB	SonoMB technology
MCA	Middle Cerebral Artery
MCCA	Mid Common Carotid Artery
MECA	Mid External Carotid Artery
MI	Mechanical Index
MICA	Mid Internal Carotid Artery
Mid	Middle
MM	M Mode
MR PISA	Mitral Regurgitation Proximal Iso Velocity Surface Area
MR/VTI	Mitral Regurgitation/Velocity Time Integral
Msk	Musculoskeletal
MV	Mitral Valve
MV Area	Mitral Valve Area
MV Regurgitant Fraction	Mitral Valve Regurgitant Fraction
MV Regurgitant Volume	Mitral Valve Regurgitant Volume
MV/VTI	Mitral Valve/Velocity Time Integral

Table A-1: Abbreviations in user interface (continued)

Abbreviation	Definition
MVA	Mitral Valve Area
MV ERO	Mitral Valve Effective Regurgitant Orifice
MV PISA Area	Mitral Valve Proximal Iso Velocity Surface Area
MV Rate	Mitral Valve Rate
Neo	Neonatal
Nrv	Nerve
NST	Non-stress test
NTSC	National Television Standards Committee
OA	Ophthalmic Artery
OB	Obstetrical
OFD	Occipital Frontal Diameter
Oph	Ophthalmic
Orb	Orbital
PAL	Phase Alternating Line
PCAp	Posterior Cerebral Artery Peak
PCCA	Proximal Common Carotid Artery
PCoA	Posterior Communicating Artery
PECA	Proximal External Carotid Artery
PGMax	Maximum Pressure Gradient
PGMean	Mean Pressure Gradient
PGr	Pressure Gradient
PHT	Pressure Half Time
PI	Pulsatility Index
PICA	Proximal Internal Carotid Artery
PISA	Proximal Isovelocity Surface Area

Table A-1: Abbreviations in user interface (continued)

Abbreviation	Definition
Plaq	Plaque
POST F	Posterior Far
POST N	Posterior Near
PRF	Pulse Repetition Frequency
Prox	Proximal
PSV	Peak Systolic Velocity
PV	Pulmonic Valve
P. Vein	Pulmonary Vein
PW	Pulsed Wave Doppler
Qp/Qs	Pulmonary blood flow divided by systemic blood flow
RA	Right Atrial (pressure)
RI	Resistive Index
RVD	Right Ventricular Dimension
RVDd	Right Ventricular Dimension Diastolic
RVDs	Right Ventricular Dimension Systolic
RVOT D	Right Ventricular Outflow Tract Diameter
RVOT VTI	Right Ventricular Outflow Tract Velocity Time Integral
RVSP	Right Ventricular Systolic Pressure
RVW	Right Ventricular Free Wall
RVWd	Right Ventricular Free Wall Diastolic
RVWs	Right Ventricular Free Wall Systolic
S'	Tricuspid Lateral Annular Systolic Velocity (TDI measurement)
S/D	Systolic/Diastolic Ratio
SI	Stroke Index
Siphon	Siphon (internal carotid artery)

Table A-1: Abbreviations in user interface (continued)

Abbreviation	Definition
SM	Submandibular
SmP	Small Parts
SNP	Steep Needle Profiling
SO	Suboccipital
Sup	Superficial
SV	Stroke Volume
TAM	Time Average Mean
TAP	Time Average Peak
TAPSE	Tricuspid Annular Plane Systolic Excursion: M Mode distance measurement of systolic excursion of the right ventricle
TAV	Time Average Velocity
TCD	Trans-cerebellum Diameter (OB measurement) Transcranial Doppler (exam type)
TDI	Tissue Doppler Imaging
THI	Tissue Harmonic Imaging
TI	Thermal Index
TICA	Terminal Internal Carotid Artery
TO	Transorbital
TRMax	Tricuspid Regurgitation (peak velocity)
TT	Transtemporal
TTD	Transverse Trunk Diameter
TV	Tricuspid Valve
TVA	Tricuspid Valve Area
UA	Ultrasound Age Calculated on the mean measurements taken for a particular fetal biometry.
Umb A	Umbilical Artery

Table A-1: Abbreviations in user interface (continued)

Abbreviation	Definition
VA	Vertebral Artery
VArty	Vertebral Artery
Vas	Vascular
Ven	Venous
VF	Volume Flow
VMax	Peak Velocity
VMean	Mean Velocity
Vol	Volume
VTI	Velocity Time Integral
YS	Yolk Sac

Index

2D

- controls **4-9**
- imaging or scanning **4-2**
- measurements **5-2**

abdominal

- calculations **5-13**
- circumference (AC) **6-16**
- exam **2-3, 2-28**
- intended uses **2-12**
- volume flow **5-14**

acceleration

- index (ACC) **6-4, 6-21**
- measurement **5-5**
- time (AT) **6-4**

accessories **2-16**

- clean and disinfect **8-13**
- list **9-15**

acoustic output

- measurement **10-9**
- tables **10-11, 10-90**
- terms **10-90**

acquisition error **6-3**

acute care

- calculations **5-44, 5-47**
- customize worksheet **5-54**
- worksheets **5-53**

adjust

- height **2-15, 2-17**
- settings **2-21**

administrator **3-2**

ALARA principle **10-1, A-1**

amniotic fluid index (AFI) **5-39, 6-15**

angle **4-18**

annotate. See labels.

aorta (Ao) **5-24, 6-7**

aortic valve area (AVA) **5-26, 5-31, 6-4**

archiving

- DICOM **3-21**
- educational **3-38**
- exam **4-44-4-45**
- images and clips **4-44**
- procedural **3-38**

area

- ellipse **5-2**
- trace **5-3**

arrows **4-31**

arterial

- calculations **5-14**
- exam **2-3, 2-28**
- intended uses **2-12**
- report **5-51**
- volume flow **5-16**

ascending aorta (AAo) **5-24**

atrial volume **5-25**

audio

- port **2-33**
- settings **3-7**

Auto Measure **5-7**

auto trace **4-21, 5-7**

auto-delete **3-5**

average ultrasound age (AUA) **6-15**

backup data **7-5**

bar code

patient **4-34**
worklist **3-35, 4-34**

baseline **4-21**

battery **2-16, 2-35**
settings **3-30**

biparietal diameter (BPD) **6-17**

body surface area (BSA) **6-4**

brightness setting **3-32**

cables. See cords

calculations
abdominal **5-13**
about **5-9**
acute care **5-44, 5-47**
arterial **5-14**
cardiac **5-18**
cardiac setup **3-7**
delete **5-10**
gynecology (Gyn) **5-34**
hip angle **5-43**
hip ratio **5-43**
musculoskeletal (Msk) **5-43**
obstetrics **5-37**
obstetrics setup **3-7**
orbital **5-47**
percent area reduction **5-11**
redo **5-10**
save **5-10**
settings **3-7**
small parts **5-43**
TCD **5-47**
volume **5-12**
volume flow **5-12**

calipers
about **5-1**
activate **5-1**
switch **5-1**

cardiac
calculations **5-18**
exam **2-3, 2-28**
intended uses **2-12**
references **6-4**
settings **3-7**

cardiac calculations
aorta (Ao) **5-24**
aortic valve area (AVA) **5-26, 5-31**
ascending aorta (AAo) **5-24**
atrial volume **5-25**
cardiac index (CI) **5-33**
cardiac output (CO) **5-33**
deceleration (Decel) **5-28**
dP to dT ratio **5-30**
EDA **5-24**
ESA **5-24**
FAC **5-24**
IVC collapse **5-27**
IVRT **5-30**
left atrium (LA) **5-24**
LV Mass **5-27**
LV volume **5-25**
LVdD **5-23**
LVdS **5-23**
LVOT D **5-24**
MAPSE **5-34**
mitral valve area (MVA) **5-26**
peak velocity **5-28**
PISA **5-22**

- pressure half time (PHT) **5-30**
- Qp/Qs **5-31**
- right atrial pressure (RAP) **5-29**
- RVSP **5-29**
- setup **3-7**
- stroke index (SI) **5-32**
- stroke volume (SV) **5-32**
- TAPSE **5-34**
- TDI waveform **5-34**
- velocity time integral (VTI) **5-28**
- cardiac index (CI) **5-33, 6-4**
- cardiac output (CO) **5-33, 6-5**
- cautions, definition 1-2
- CDA
 - profiles **3-11**
 - report control **3-11**
- centerline **4-14**
- cephalic index (CI) **6-15**
- cine **4-6, 4-24**
- circumference
 - ellipse **5-2**
 - trace **5-3**
- Cisterna Magna (CM) **6-17**
- cleaning
 - accessories **8-13**
 - methods **8-2**
 - Spaulding classification **8-2**
 - stand **8-14**
 - system and transducer **8-3, 8-8**
 - transducer connect **8-14**
- clinical monitor. See monitor
- clips
 - play **4-42**
 - record **4-49**
 - save **4-47**
 - See also images and clips
- Color
 - controls **4-16**
 - imaging or scanning **4-3**
 - steering **4-16**
- Color Doppler Variance (Var) **2-12, 2-32, 4-16**
- Color Power Doppler (CPD) **2-12, 2-32, 4-16**
- Color Velocity Doppler (CVD) **2-12, 2-32**
- connectivity setup **3-12**
- continuous wave (CW) Doppler **2-12, 2-32, 4-4, 4-18**
- contraindications **2-14**
- controls **2-21**
 - 2D **4-9**
 - Color **4-16**
 - customize **3-35, 4-9**
 - direct **10-2**
 - D-line **4-18**
 - Doppler **4-18**
 - imaging or scanning **4-8**
 - indirect **10-2**
 - M Mode **4-18**
 - more controls **4-8**
 - receiver **10-2**
 - reset **3-35**
 - update **4-15, 4-19**
- cords
 - inspect **9-4**
 - power **2-16, 9-16**

- cross sectional area (CSA) **6-5**
- crown rump length (CRL) **6-17**
- deceleration (Decel)
 - cardiac **5-28**
 - Doppler **5-7**
- deceleration time (Decel) **6-5**
- delta pressure (dP) delta time (dT) **5-30, 6-5**
- depth
 - adjust **4-22**
 - definition **A-1**
 - measure **4-11, 5-3**
 - scale **4-22**
 - target **4-11, 5-3**
- DICOM **11-2**
 - archiving **3-21**
 - configure **3-17**
 - locations **3-18, 3-26**
 - log **3-28**
 - MPPS **3-25**
 - printer **3-22**
 - standards **9-36**
 - storage commit **3-24**
 - transfer **3-15**
 - worklist **3-24**
- digital video **2-21, 2-33**
- disinfecting
 - accessories **8-13**
 - methods **8-2**
 - Spaulding classification **8-2**
 - system and transducer **8-3, 8-8**
- display format **4-15**
- distance
 - 2D **5-2**
 - M Mode **5-3**
- D-line **4-4**
 - angle **4-18**
 - controls **4-18**
 - gate size **4-18**
 - steering **4-18, 4-20**
- Doppler
 - controls **4-18**
 - D-line **4-4, 4-18**
 - gate size **4-18**
 - imaging or scanning **4-4**
 - measurements **5-4**
 - scale setup **3-31**
 - steering **4-18, 4-20**
 - sweep speed **4-20**
 - trace **5-6**
 - types **4-4**
- Dual
 - cine viewing **4-6**
 - imaging or scanning **4-5**
 - update **4-19**
- DVR
 - port **2-18, 2-33**
 - recording **2-18, 4-49**
 - troubleshoot **7-2**
- dynamic range **4-11**
- E/Ea ratio **6-5**
- ECG **4-52**
- EDD
 - average ultrasound age (AUA) **6-15**
 - last menstrual period (LMP) **6-15**
- effective regurgitant orifice (ERO) **6-6**
- e-Film Lite **3-40**

EFW percentile **5-39, 6-16**
ejection fraction (EF) **6-6, 6-10**
elapsed time (ET) **6-6, 6-21**
electrical safety **9-3**
electromagnetic compatibility **9-10**
electromechanical safety standards **9-35**
EMC classification standards **9-36**
end exam **4-37**
End-Diastolic Area (EDA) **5-24**
End-Systolic Area (ESA) **5-24**
equipment safety **9-7**
error
 acquisition **6-3**
 algorithmic **6-3**
 measurement **6-3**
 message **9-5**
estimated date of delivery
 average ultrasound age (AUA) **6-15**
 last menstrual period (LMP) **6-15**
estimated fetal weight (EFW) **5-38, 6-15**
Ethernet **2-34**
ethernet **2-33, 3-15**
exam
 archive **4-44–4-45**
 custom **3-33–3-34**
 delete **4-41**
 end **4-37**
 export **4-46**
 images and clips **4-42**
 information **4-45**
 routing **3-37**
 Steep Needle Profiling (SNP) **4-26**
 transfer **4-44**
 type and transducer **2-3, 2-28, 3-33**
 type, change **2-27**
 types, manage **3-33**
 verify transfer **4-44**
export
 connectivity settings **3-13**
 exams **4-46**
 images and clips **4-51**
 logs **3-29**
 settings **3-36**
 USB **4-46**
femur length (FL) **6-17**
fetal trunk cross-sectional area (FTA) **6-17**
FL/AC ratio **6-20**
FL/BPD ratio **6-20**
FL/HC ratio **6-20**
flow state **4-16**
follicles **5-35, 6-23**
footswitch **3-35**
fractional area change (FAC) **5-24, 6-6**
freeze **4-24**
gain
 adjust **4-23**
 AutoGain **4-10, 4-23**
 controls **10-2**
gate size **4-18**
gel **2-32**
gestational age
 calculation **6-16**
 measurements **5-38**
 setup **3-7**
 tables **3-7, 6-16**
gestational growth

- measuring **5-39**
- tables **3-7, 6-19**
- gestational sac (GS) **5-42, 6-18**
- grayscale **4-11**
- growth analysis
 - setup **3-7**
 - tables **5-39, 6-19**
- gynecology
 - calculations **5-34**
 - exam **2-3, 2-28**
 - intended uses **2-13**
- HC/AC ratio **6-21**
- head circumference (HC) **6-18**
- heart rate (HR)
 - enter **4-38**
 - gestational **5-40**
 - measure **5-4, 5-33**
 - reference **6-6**
- height
 - adjust **2-15, 2-17**
- hip
 - angle **5-43**
 - ratio **5-43, 6-21**
- HIPAA standard **9-36**
- home **4-32**
- humerus length (HL) **6-18**
- humidity limits **9-34**
- image quality, poor **7-1**
- images and clips
 - archive **4-44**
 - delete **4-43**
 - exam **4-42**
 - export **4-51**
 - export to USB **3-39**
 - file formats **3-39**
 - image gallery **4-51**
 - review **4-32, 4-40**
 - save **4-47**
 - view **4-51**
- imaging
 - 2D **4-2**
 - Color **4-3**
 - controls **4-8**
 - data **3-28**
 - Doppler **4-4**
 - Dual **4-5**
 - M Mode **4-2**
 - modes, list of **9-34**
 - optimize **4-10**
 - orientation **4-10**
 - procedure mode **4-11**
 - Simultaneous **4-7**
 - transducers **2-3, 2-28**
- import
 - connectivity settings **3-13**
 - settings **3-36**
- in situ, definition **A-1**
- inferior vena cava (IVC) **5-27, 6-7**
- infertility, intended uses **2-13**
- information form **4-33**
 - edit **4-33**
 - fields **4-37**
 - manual **4-34**
 - worklist **4-34**
- intended audience **1-1, 2-2**
- intensity

derated **10-9**
 in situ **10-9**
 water-value **10-9**
 interventional, intended uses **2-13**
 interventricular septum (IVS) fractional thickening **6-7**
 invert **4-17**
 isolate system **9-6**
 isovolumic relaxation time (IVRT) **5-30, 6-7**
 JPEG format **3-40**
 keyboard **2-23**
 labels
 arrows **4-31**
 in review **4-32**
 mark out **4-32**
 pictographs **4-31**
 place **4-30**
 settings **3-32**
 text **4-30**
 last menstrual period (LMP)
 calculation **6-16**
 reference **6-15**
 left atrium (LA) **5-24, 6-7**
 left ventricular (LV)
 dimension diastolic (LVDd) **5-23**
 dimension fractional shortening **6-10**
 dimension systolic (LVDs) **5-23**
 ejection fraction **6-10**
 end volumes **6-8**
 FAC **6-6**
 mass **5-27, 6-8**
 opacification (LVO) **4-9**
 outflow tract diameter (LVOT D) **5-24**
 posterior wall fractional thickening **6-10**
 volume **5-25**
 volume (biplane) **6-9**
 volume (single plane) **6-10**
 license key **2-15, 7-3**
 limits
 humidity **9-34**
 operating **9-34**
 pressure **9-34**
 LMPd **6-16**
 locations
 DICOM **3-18, 3-26**
 system **3-12**
 lock wheel **2-15, 2-17**
 login **3-6**
 administrator **3-2**
 user **3-3**
 logs
 assert **3-28**
 clear **3-30**
 DICOM **3-28**
 export **3-29**
 settings **3-29**
 user **3-28**
 lung exam **2-3, 2-28**
 M Mode
 controls **4-18**
 imaging or scanning **4-2**
 measurements **5-3**
 M-line **4-2**
 sweep speed **4-14**
 maintenance **7-2, 7-5**
 MAPSE **5-34, 6-11**

mean velocity **6-11**
measurements
 2D **5-2**
 about **5-1**
 acceleration **5-5**
 accuracy **6-1**
 amniotic fluid index (AFI) **5-39**
 area **5-2**
 assigning to calculations **5-8**
 auto trace **4-21, 5-7**
 circumference **5-2**
 deceleration (Decel) **5-7**
 delete **5-2**
 depth **4-11, 5-3**
 distance **5-2-5-3**
 Doppler **5-4**
 EFW **5-38**
 elapsed time **5-5**
 ellipse **5-2**
 error **6-3**
 follicle **5-35**
 gestational age **5-38**
 gestational growth **5-39**
 gestational sac **5-42**
 heart rate **5-4, 5-33, 5-40**
 in review **5-57**
 M Mode **5-3**
 orbital **5-47**
 ovary **5-35**
 pressure gradient (PG) **5-5**
 pressure half time (PHT) **5-7**
 publications **6-3**
 ratio **5-5**
 resistive index (RI) **5-5**
 slope **4-22, 5-7**
 target depth **5-3**
 TCD **5-47**
 terminology **6-3**
 time **5-3, 5-5**
 tracing **5-3**
 uterus **5-35**
 velocity **5-5**
 VMax **5-7**
mechanical index (MI) **10-7, A-1**
middle cerebral artery (MCA) **5-40**
mitral valve (MV)
 area **5-26, 6-11**
 flow rate **6-11**
M-line **4-2**
mode data **3-28**
monitor **2-15, 2-19**
 adjust **2-17**
 collapse **2-18**
 display **3-28**
 layout **2-20**
MPPS
 discontinue **4-45**
 servers **3-25**
musculoskeletal (Msk)
 calculations **5-43**
 exam **2-3, 2-28**
 worksheets **5-53**
needle
 angle **4-28**
 guide **4-11, 4-26**
 size **4-29**

- visualization **4-26**
- neonatal
 - exam **2-3, 2-28**
 - intended uses **2-13**
- nerve exam **2-3, 2-28**
- network
 - connection **3-12, 3-15**
 - specifications **11-1**
 - status **3-30**
 - troubleshooting **11-3**
 - verify connection **3-27**
 - wireless **3-16**
- obstetrical
 - calculations **5-37**
 - calculations setup **3-7**
 - custom measurements **3-8**
 - exam **2-3, 2-28**
 - graphs **5-52**
 - intended uses **2-13**
 - references **6-15**
 - report **5-52**
 - tables **3-7, 6-16**
- occipital frontal diameter (OFD) **6-18, 6-20**
- ophthalmic exam **2-3, 2-28**
- optimize **4-10**
- orbital
 - calculations **5-47**
 - measurements **5-47**
- orientation **4-10**
- output display **10-7**
- ovary **5-35, 6-23**
- password
 - administrator **3-2**
 - change **3-6**
 - user **3-4**
- patient
 - header **3-28**
 - information **4-33, 4-37, 4-42**
 - list **4-40, 4-42**
- pedal **2-15, 2-17**
- pediatric.neonatal
- percent area reduction **5-11, 6-21**
- percent diameter reduction **5-11, 6-22**
- peripherals **2-16, 9-15**
- pictographs **4-31**
- PISA **5-22, 6-12, A-9**
- platform **2-15**
 - adjust **2-17**
- ports
 - audio **2-33**
 - digital video **2-21, 2-33**
 - dock **2-15, 2-33**
 - DVR **2-18, 2-33**
 - ethernet **2-33**
 - USB **2-15, 2-18, 2-33**
- power
 - cord **2-16, 9-16**
 - delay **3-31**
 - isolate from **9-6**
 - switch **2-15–2-17**
- pressure gradient (PG) **5-5, 5-28, 6-11, 6-22**
- pressure half time (PHT) **5-7, 5-30, 6-12**
- pressure limits **9-34**
- print **4-43**
 - worksheets and reports **5-54**

- printer
 - DICOM **3-22**
 - troubleshoot **7-2**
- probe. See transducer
- procedure mode **4-11**
- pulsatility index (PI) **5-40, 6-22**
- pulse repetition frequency (PRF) **4-16, A-10**
- pulsed wave (PW) Doppler **2-12, 2-32, 4-4, 4-18**
- Qp/Qs **5-31, 6-12, A-10**
- ratio calculations **5-5, 5-39, 6-20**
- record
 - clips **4-49**
 - troubleshoot **7-2**
- references
 - cardiac **6-4**
 - general **6-21**
 - obstetrical **6-15**
- regurgitant
 - ERO **6-6**
 - fraction (RF) **6-12**
 - volume (RV) **6-13**
- remove engine **7-7**
- reports **5-50**
 - arterial **5-51**
 - displaying **5-54**
 - obstetrics **5-52**
 - preview **5-51**
 - printing **5-54**
- resistive index (RI) **5-5, 5-40, 6-23**
- review
 - images and clips **4-32, 4-40**
 - labels **4-32**
 - measure **5-57**
- right atrial (RA)
 - pressure **5-29**
 - volume **6-13**
 - volume index **6-13**
- right ventricular (RV), FAC **6-6**
- right ventricular systolic pressure (RVSP) **5-29, 6-13**
- routing selections **3-36**
- S/D **5-40, 6-13, A-10**
- safety
 - electrical **9-3**
 - electromagnetic compatibility **9-10**
 - equipment **9-7**
- save
 - exam type **3-34**
 - images and clips **4-47**
- scale
 - depth **4-22**
 - PRF **4-16**
- scanhead. See transducer
- scanning
 - 2D **4-2**
 - Color **4-3**
 - controls **4-8**
 - Doppler **4-4**
 - Dual **4-5**
 - M Mode **4-2**
 - optimize **4-10**
 - orientation **4-10**
 - procedure mode **4-11**
 - Simultaneous **4-7**
- scheduled procedures **4-35**

- sector width **4-11**
- security
 - internet **3-19**
 - settings **3-2**
- settings
 - adjust **2-21**
 - battery **3-30**
 - brightness **3-32**
 - cardiac **3-7**
 - date and time **3-27**
 - display **3-28**
 - exam types **3-33**
 - export **3-36**
 - import **3-36**
 - labels **3-32**
 - logs **3-29**
 - pages **3-1**
 - storage **3-5**
 - USB **3-39**
- ship
 - specifications **9-34**
 - transducer **8-12, 9-34**
- Simpson's Rule **5-25**
- Simultaneous
 - imaging or scanning **4-7**
- skin line, definition **A-1**
- sleep mode **3-31**
- slope **4-22, 5-7**
- small parts
 - calculations **5-43**
 - exam **2-3, 2-28**
 - intended uses **2-14**
- SNP **A-11**
- software license **2-15, 7-3**
- SonoMB **4-10**
- sound **3-7**
- specifications
 - operating **9-34**
 - shipping **9-34**
 - storage **9-34**
- stand, clean and disinfect **8-14**
- standards
 - DICOM **9-36**
 - electromechanical **9-35**
 - EMC classification **9-36**
 - HIPAA **9-36**
- Steep Needle Profiling (SNP) **A-1**
 - exam types and transducers **4-26, 4-28**
 - needle size and angle **4-29**
 - recommendations **4-29**
- steering
 - Color **4-16**
 - D-line **4-18, 4-20**
 - Doppler **4-18, 4-20**
- storage
 - alerts **3-13**
 - commit servers **3-24**
 - images **9-34**
 - images and clips **4-40**
 - internal **3-5, 4-48**
 - specifications **9-34**
 - transducer **9-34**
- stroke index (SI) **5-32, 6-14**
- stroke volume (SV) **5-32, 6-14**
- superficial
 - exam **2-3, 2-28**

- intended uses **2-14**
- sweep speed
 - Doppler **4-20**
 - M Mode **4-14**
- system
 - controls **2-21**
 - information **3-38**
 - isolate from power **9-6**
 - location **3-12**
 - log **3-28**
 - network **3-12, 3-15**
 - software **2-15**
 - transport **2-35**
- TAPSE **5-34, 6-14, A-11**
- target depth **5-3**
- technical support **1-3**
- temperature limits **9-34**
- text
 - enter **2-23**
 - label **4-30**
- thermal index (TI) **3-31, 10-7, A-2**
- tibia **6-18**
- time
 - Doppler **5-5**
 - elapsed **5-5**
 - M Mode **5-3**
- time averaged mean (TAM) **6-23**
- time averaged peak (TAP) **6-23**
- Tissue Doppler imaging (TDI) **A-1**
- tissue Doppler imaging (TDI) **4-4, 4-18, 5-34**
- tissue harmonic imaging (THI) **4-9, 10-2, A-2**
- tissue models **10-10**
- touch panel **2-15, 2-21**
- adjust **2-18**
- trace
 - area or circumference **5-3**
 - auto **4-21, 5-7**
 - Doppler **5-6**
 - manual **5-6**
- Transcranial Doppler (TCD)
 - calculations **5-47**
 - measurements **5-47**
- transcranial, intended uses **2-14**
- transducer
 - connect **2-15, 2-24, 8-14, 9-13**
 - curved array **A-1**
 - definition **A-2**
 - exam type **2-3, 2-28**
 - general use **2-32**
 - imaging modes **2-3, 2-28**
 - linear array **A-1**
 - preparation **2-32**
 - problems **7-2**
 - remove **2-27, 7-7**
 - select **2-27**
 - sheath **2-32**
 - ship **8-12, 9-34**
 - Steep Needle Profiling (SNP) **4-26**
 - storage **9-34**
 - store **8-11**
 - transport **8-11-8-12**
- transport
 - system **2-18, 2-35**
 - transducer **8-11-8-12**
- transverse trunk diameter (TTD) **6-18**
- tricuspid valve area (TVA) **6-14**

- troubleshoot **1-3, 7-1**
- ultrasound terms **10-90, A-1**
- umbilical artery (UmbA) **5-40**
- update
 - control **4-15, 4-19**
 - Dual **4-19**
 - worklist **4-36**
- USB
 - devices **2-18**
 - export **3-39, 4-46**
 - insert or remove device **2-19**
 - ports **2-15, 2-18, 2-33-2-34**
 - settings **3-39**
 - troubleshoot **7-2**
- user
 - add new **3-4**
 - logs **3-28**
 - password **3-4**
 - setup **3-3**
- user guide, conventions used **1-2**
- uterus **5-35, 6-23**
- vascular
 - exam. See *also* arterial and venous
 - intended uses **2-12**
- velocity
 - maximum (VMax) **5-7, 5-28**
 - mean (VMean) **5-28, 6-11**
 - measure **5-5**
 - measurement **5-5**
 - peak **5-28**
 - time integral (VTI) **5-28**
- velocity time integral (VTI) **5-4**
 - calculation reference **6-15**
- venous
 - exam **2-3, 2-28**
 - intended uses **2-12**
- video
 - instructional **2-37**
 - output **2-21**
- visualize needles **4-26**
- volume **3-7**
 - atrial **5-25**
 - bladder **6-23**
 - calculations **5-12**
 - follicle **6-23**
 - LV **5-25**
 - ovarian **6-23**
 - reference **6-23**
 - uterine **6-23**
- volume flow **5-12**
 - abdominal **5-14**
 - arterial **5-16**
 - reference **6-23**
- wall filter **4-16**
- warnings, definition **1-2**
- wheel, lock **2-15, 2-17**
- wireless
 - certificates **3-17**
 - network **3-16**
 - transmission **9-12**
- worklist
 - configure **3-24**
 - patient information **4-34**
 - query **4-36**
 - scan **3-35**
 - scheduled procedures **4-35**

servers **3-24**
update **4-36**
worksheets **5-50**
acute care and Msk **5-53**
arterial **5-51**
custom **5-55**
obstetrics **5-52**
printing **5-54**
remote **5-55**
zoom **4-25**

FUJIFILM
Value from Innovation

SonoSite

P14645-07

