



Orthopedics

Orthopedics

1

Knee

2

Shoulder

3

Hip

4

Elbow / Foot

5

Hand / Fingers / Toes

6

FLUID MANAGEMENT Suction and Irrigation Pumps

7

Universal Motor Systems

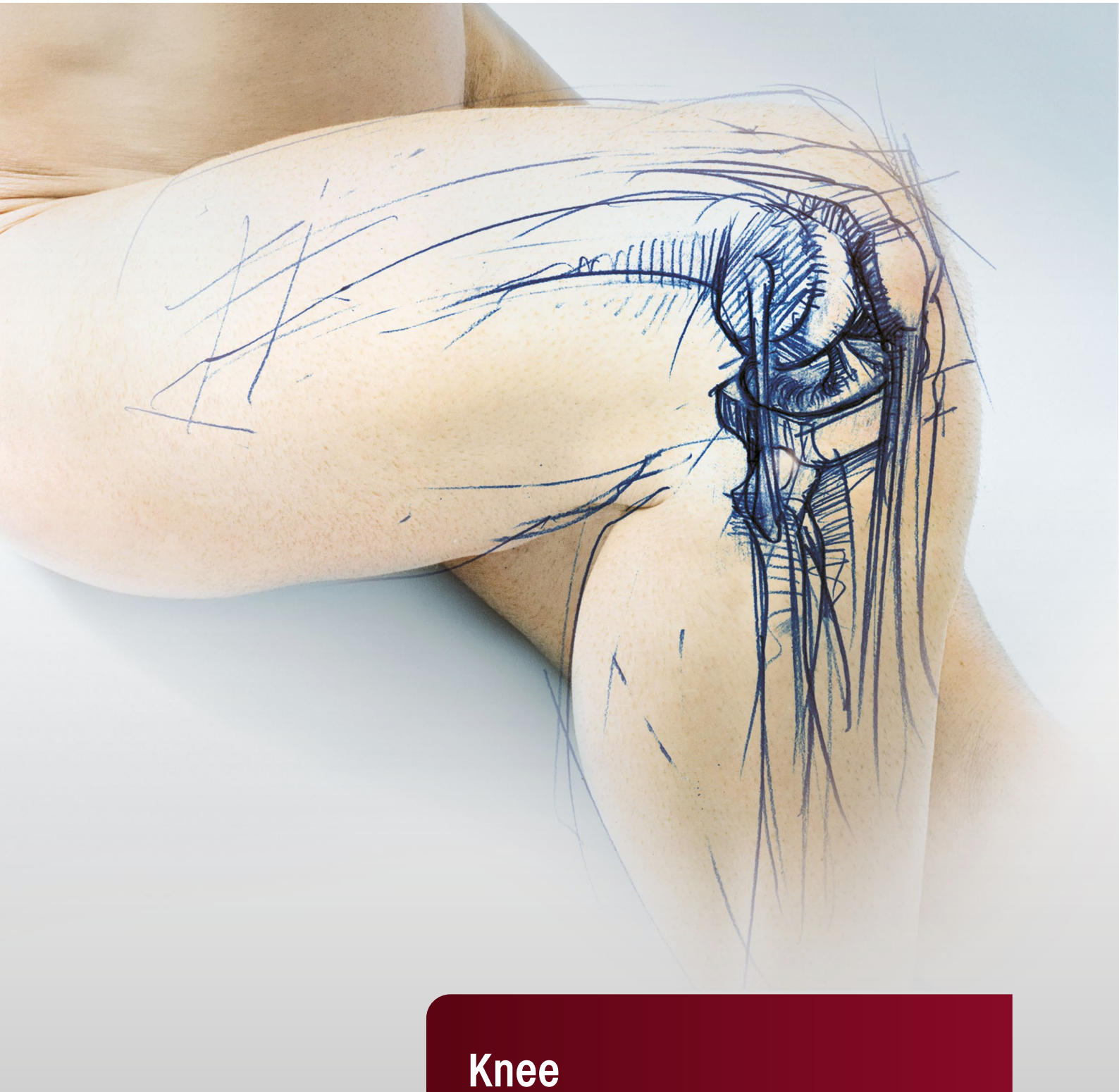

Knee

Knee

1.1

Standard Equipment

1.2

Meniscal and Soft Tissue Resection / Extraction

1.3

Meniscus Refixation

1.4

Treatment of Cartilage Defects

1.5

Cruciate Ligament Reconstruction

1.6

Leg Holders

Basic Equipment

for diagnostic and operative arthroscopy

Product	Product no.	Quantity	Catalog / Section
Endoscopes and Instruments			
PANOVIEW telescope 30° Ø 4mm SL 170mm	8880.543	1	Orthopedics / Knee
Sheath for arthroscope OD 6mm	89121.1260	1	Orthopedics / Knee
Obturator for arthroscope OD 5.5/6/6.3mm	89121.0542	1	Orthopedics / Knee
Fiber light cable bndl, Ø 3.5 mm, 2.3 m long	806635231	1	Orthopedics / Knee
Hook probe WL 115mm H 4.5mm	8399.95	1	Orthopedics / Knee
ARTHROline punch W 4.6mm H 1.6mm, straight sheath	89140.0102	1	Orthopedics / Knee
ARTHROline punch W 5.5mm H 1.6mm, sheath curved to the left	89140.0101	1	Orthopedics / Knee
ARTHROline punch W 5.5mm H 1.6mm, sheath curved to the right	89140.0103	1	Orthopedics / Knee
ARTHROline hook punch W 3mm H 1.6mm, straight sheath	89140.0202	1	Orthopedics / Knee
Grasping forceps Ø 3.4mm	8488.096	1	Orthopedics / Knee
Meniscus grasping forceps Ø 4/7mm	8403.001	1	Orthopedics / Knee
Treatment of Cartilage Defects – Microfracture			
Curette, round, Ø 4.5mm WL 95mm	8435.902	1	Orthopedics / Knee
Curette, round, Ø 6mm WL 95mm	8435.903	1	Orthopedics / Knee
Microfractor WL 170mm 15°	891631521	1	Orthopedics / Knee
Microfractor WL 170mm 30°	891633021	1	Orthopedics / Knee
Microfractor WL 170mm 35°	891633522	1	Orthopedics / Knee
Microfractor WL 170mm 45°	891634521	1	Orthopedics / Knee
Microfractor WL 170mm 60°	891636021	1	Orthopedics / Knee
Shaver Set			
PowerSpeed AS1 MOTOR CONTROL UNIT 2305	2305001	1	Orthopedics / Motor Systems
Remote footswitch 2 pedals+2 buttons	2305100	1	Orthopedics / Motor Systems
Motor handpiece max. 16000rpm	8995500031	1	Orthopedics / Motor Systems
Resector toothed Ø 4.5mm	89975.0034	1	Orthopedics / Motor Systems
Resector oval, Ø 4.5mm	89975.0114	1	Orthopedics / Motor Systems
Resector aggress Ø 4.7mm	89975.0334	1	Orthopedics / Motor Systems
Acromionizer Ø 5.5mm	89975.0555	1	Orthopedics / Motor Systems
Fluid Management			
FLUID CONTROL arthro/spine suc./irrig.pump bndl	22040011	1	Orthopedics / FLUID CONTROL Suction irrigation pump
Irrigation tube set spike L 3m	4171223	1	
Imaging			
ENDOCAM Logic HD Camera Controller bndl	55251051	1	Imaging / ENDOCAM
ENDOCAM Logic HD camera head cable 3 m	85525922	1	Imaging / ENDOCAM
RIWO zoom lens F 13–29mm	85261504	1	Imaging / ENDOCAM
Light source LED 2.2 bndl	51640011	1	Imaging / Light Sources
Light source LED 1.1 bndl	51600011	1	Imaging / Light Sources
LCD monitor 27" 4K	LMD-X2705N	1	Imaging / Monitors
Monitor mount VESA 75/100	321165001	1	Imaging / Device Carts

arthro *lution* Arthroscope

Overview



Knee
1.1

arthro <i>lution</i>			Fingers, toes	Hand	Foot, elbow		Knee, shoulder, hip
Telescope Ø			1.9 mm	2.4 mm	2.7 mm		4.0 mm
Telescopes	30°	PANOVIEW telescope	8860453	8871413	8476.433	8672.422	8880.543
		PANOVIEW wide angle telescope					8885.443
	70°	PANOVIEW telescope					8880.545
		PANOVIEW wide angle telescope					8885.445
Sheath WL			40 mm	60 mm	77.5 mm	145 mm	130 mm
Sheaths	with 1 irrigation stopcock, fixed		891220124	891220132			
	with 2 irrigation stopcocks, fixed						89121.0260
	with 1 irrigation stopcock, rotatable					891241141	
	with 2 irrigation stopcocks, rotatable			891221232	891221241	891241241	89121.1260
	High-Flow with 1 irrigation stopcock, fixed		891220128				
	High-Flow with 2 irrigation stopcocks, rotatable			891221235			89121.1263
	Small-caliber with 2 irrigation stopcocks, rotatable						891221255
Obturator	blunt				891222754		89121.0544
	semi-blunt		891221952	891222452			89121.0542
	conical blunt				891222750	891242750	89121.0540
	sharp					891242761	89121.0640
	conical pointed		891221962	891222462	891222762		
Sealing part for sheath						891040000	

|| Subject to modifications. Please note that some products may not be available in all countries. For more detailed information, please consult with your contact partner or directly with Richard Wolf GmbH.

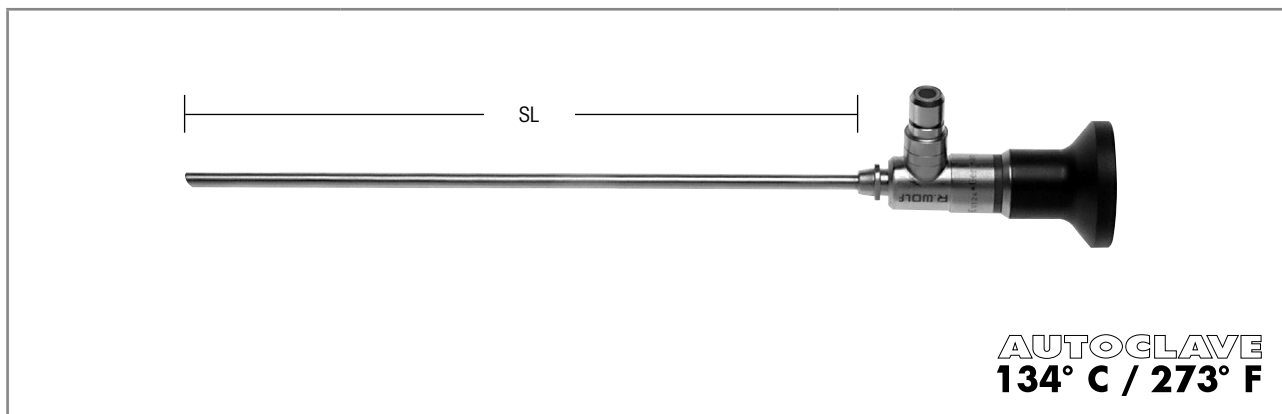
Arthroscope with PANOVIEW Telescope Ø 4 mm

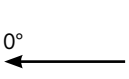

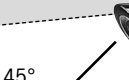
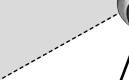
Direction of view		SL	Ø	Product no.
	PANOVIEW telescope 0° Ø 4mm SL 170mm	170 mm	4.0 mm	8880.541
	PANOVIEW telescope 30° Ø 4mm SL 170mm			8880.543
	PANOVIEW telescope 45° Ø 4mm SL 170mm			8880.544
	PANOVIEW telescope 70° Ø 4mm SL 176mm	176 mm		8880.545

Recommended accessories		Product no.
Perf. basket for standard telescope 1	(L x B x H) 297 x 59 x 54 mm	38015
Fiber light cable bndl Comprising: Fiber light cable (80663523), adapter, projector to light cable (8095.07), and adapter, light cable to endoscope (809509)	Ø 3.5 mm, 2.3 m long	806635231

Arthroscope with PANOVIEW Wide Angle Telescope

Knee

1.1

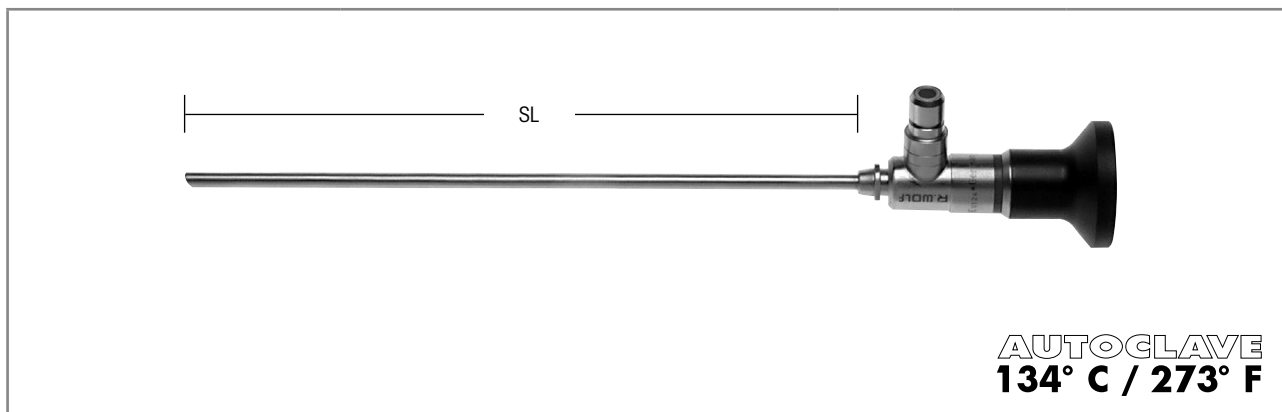

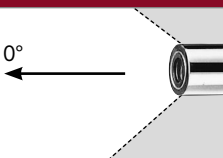
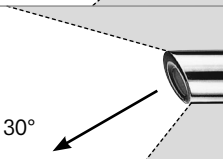
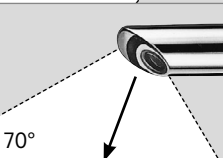



Direction of view		SL	Ø	Product no.
 0°	PANOVIEW Wide angle telescope 0° Ø 4mm SL 171mm	171 mm	4.0 mm	8885.441
 30°	PANOVIEW Wide angle telescope 30° Ø 4mm SL 170mm	170 mm		8885.443
 70°	PANOVIEW Wide angle telescope 70° Ø 4mm SL 176mm	176 mm		8885.445

Recommended accessories		Product no.
Perf. basket for standard telescope 1	(L x B x H) 297 x 59 x 54 mm	38015
Fiber light cable bndl Comprising: Fiber light cable (80663523), adapter, projector to light cable (8095.07), and adapter, light cable to endoscope (809509)	Ø 3.5 mm, 2.3 m long	806635231

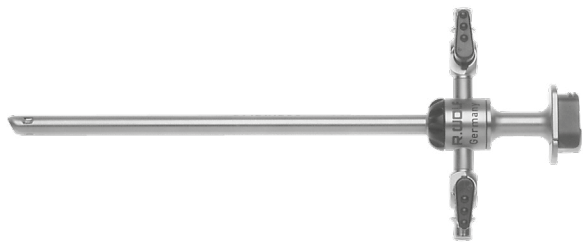
arthro^{lution} Sheath for Arthroscope

with automatic click-lock mechanism

										
Sheath for arthroscope OD 6mm							Obturator for arthroscope 5.5/6/6.3mm blunt	Obturator for arthroscope 5.5/6/6.3mm semi-blunt	Obturator for arthroscope 5.5/6/6.3mm conical blunt	Trocar tip, triangular SZ 4mm WL 176mm
High-Flow	Small-caliber	2 fixed stopcocks	2 rotatable stopcocks	Outer Ø	WL	Product no.				
		●		6.0 mm	132 mm	89121.0260	89121.0544	89121.0542	89121.0540	89121.0640
			●	6.0 mm	130 mm	89121.1260				
●			●	6.3 mm	130 mm	89121.1263				
	●		●	5.5 mm	130 mm	891221255				

Spare parts	Product no.
Irrigation ring with 1 stopcock	150081761
Irrigation ring with 2 stopcocks	150081762
Stopcock insert, bundle, cap 3.0mm (PACK= 5 PCS) Also: Disassembly tool	896.0002 38310.0001
Mounting ring	15008.1704
Spare sealing comprising: O-rings, small / large, 5 of each Also: O-ring tool (disassembly tool)	15176.142 15106.230





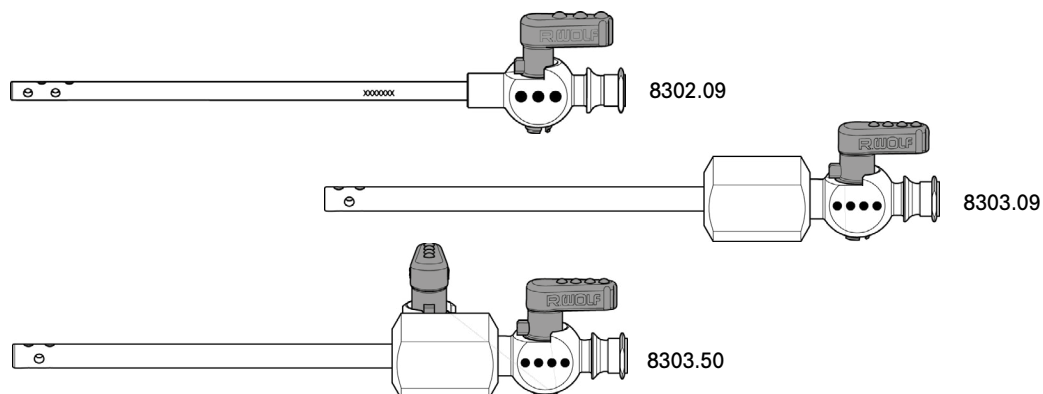

Recommended accessories	Product no.
Sealing part for sheath	89101.0000
Marking rod Ø 4.0mm conical blunt TL 325 mm	8863.75

Knee
1.1

VI121 || Subject to modifications. Please note that some products may not be available in all countries. For more detailed information, please consult with your contact partner or directly with Richard Wolf GmbH.

Drainage Cannula Ø 2.3 mm / 3.7 mm





Drainage for cannula and obturator		Capacity	Ø	WL	Product no.
Drainage for cannula Ø 3.2 mm WL 80 mm with 1 insufflation stopcock		2.3 mm	3.2 mm	80 mm	8302.09
Drainage for cannula Ø 4.5 mm WL 71.5 mm with 1 insufflation stopcock		3.7 mm	4.5 mm	71.5 mm	8303.09
Drainage for cannula Ø 4.5 mm WL 71.5 mm with 2 insufflation stopcocks		3.7 mm	4.5 mm	71.5 mm	8303.50
Obturator for cannula OD 3.2 mm sharp, with slanted tip		-	2.3 mm	103 mm	8302.101
Obturator for cannula OD 3.2 mm conical blunt tip		-	2.3 mm	103 mm	8302.11
Obturator for cannula OD 4.5 mm sharp, with pyramid-shaped tip		-	4.5 mm	115 mm	8303.10
Obturator for cannula OD 4.4 mm conical blunt tip		-	4.4 mm	115 mm	8303.11
Also:					
Silicone tube with Luer fitting 886.00	for Drainage for cannula 8302.09		Length 2.0 m		8302.90
Silicone tube with Luer fitting 886.01	for Drainage for cannula 8303.09 / 50				8303.90

VII21 || Subject to modifications. Please note that some products may not be available in all countries. For more detailed information, please consult with your contact partner or directly with Richard Wolf GmbH.

Hook Probe / Marking Rod



	H	WL	Product no.
Hook probe WL 115mm H 7mm, graduated 	7.0 mm	115 mm	8399.901
Hook probe WL 115mm H 4.5mm, graduated 	4.5 mm		8399.95

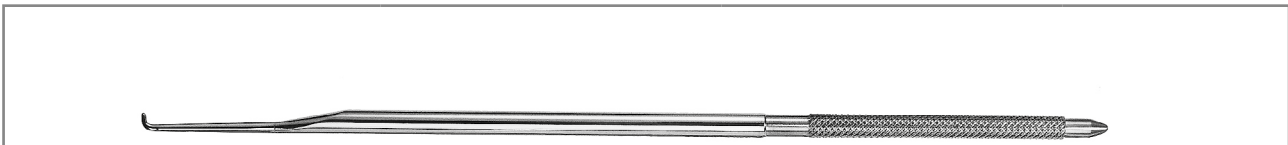

	Ø	TL	Product no.
Hook probe TL 228 mm SZ 4.4mm 	4.4 mm	228 mm	8863.80



	Ø	TL	Product no.
Marking rod Ø 4.0mm conical blunt 	4.0 mm	325 mm	8863.75

V1121 || Subject to modifications. Please note that some products may not be available in all countries. For more detailed information, please consult with your contact partner or directly with Richard Wolf GmbH.



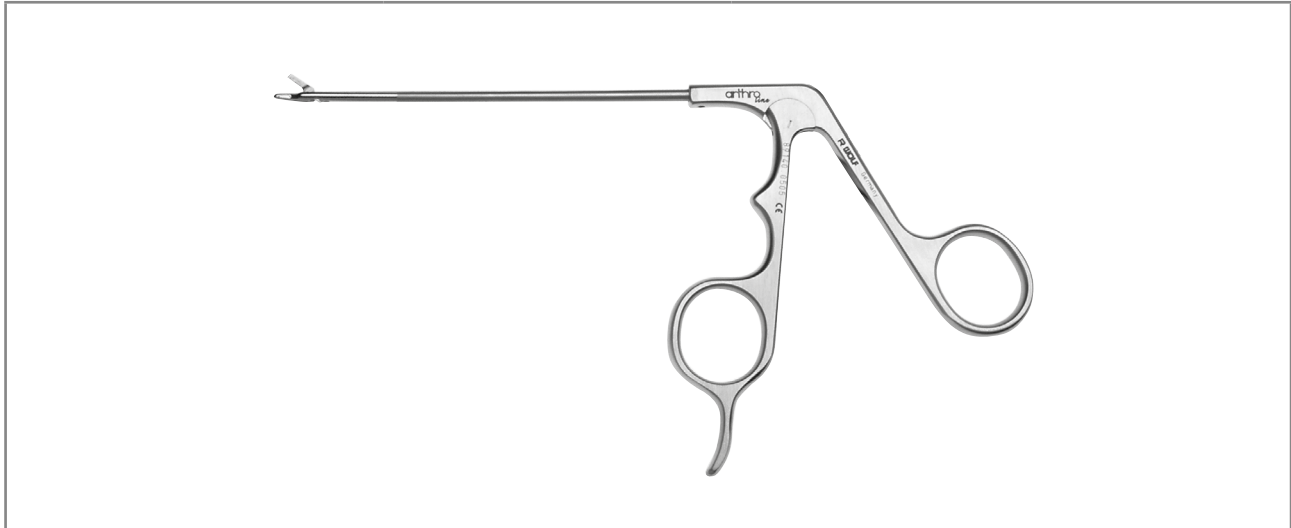

Knee
1.1

arthro *line* Punch

Versions









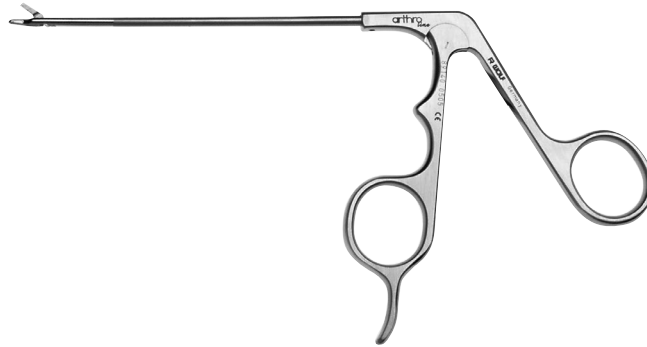



Knee
1.2

Version		Use
	Straight	For direct access
	Jaws curved 15° upward	Facilitates use, e.g., around the posterior horn
	Sheath curved 15° upward	Tailored to the anatomy of the condyles
	Curved to the left	Better access to the anterior and posterior meniscus
	Curved to the right	

arthro
line Punch



ARTHROline	Jaw section (Height x width)	Cut width	WL	Straight	Curved to the right	Curved to the left	Sheath curved upward	Jaw section curved upward	Product no.	
Punch W 4.6mm H 1.6mm movable jaw section serrated  Sectional view: 	1.6 x 4.6 mm	3.3 mm	120 mm	●					89140.0105	
Punch W 4.6mm H 1.6mm movable jaw section serrated  Sectional view: 								●	89140.0102	
Punch W 4. mm H 1.6mm movable jaw section serrated  Sectional view: 									●	89140.0122
Punch W 5.5mm H 1.6mm movable jaw section serrated  Sectional view: 								●		89140.0101
Punch W 5.5mm H 1.6mm movable jaw section serrated  Sectional view: 							●			89140.0103

arthro
line Hook Punch / Basket Punch

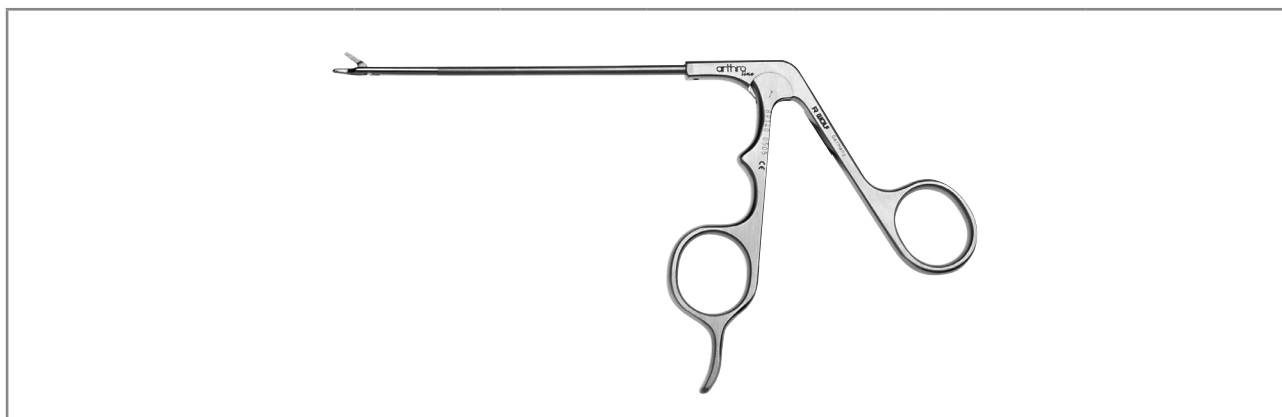







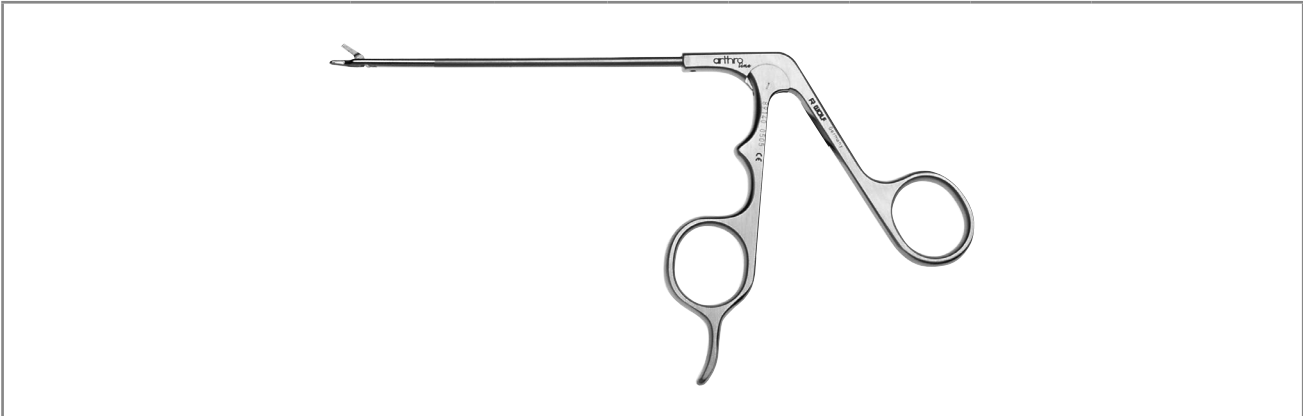

ARTHROline	Jaw section (Height x width)	Cut width	WL	Straight	Jaw section curved upward	Product no.
Hook punch W 3mm H 1.6mm  Sectional view: 	1.6 x 3.0 mm	1.8 mm	120 mm	●		89140.0205
Hook punch W 3mm H 1.6mm  Sectional view: 				●	89140.0202	
Basket punch W 6.5mm H 2.1mm oval  Sectional view: 	2.1 x 6.5 mm	4.5 mm		●		89140.0305
Basket punch W 6.5mm H 2.1mm oval  Sectional view: 				●	89140.0302	
Hook punch W 4mm H 2.1mm  Sectional view: 	2.1 x 4.0 mm	2.1 mm		●		89140.0405
Hook punch W 4 mm H 2.1mm  Sectional view: 				●	89140.0402	

VI/21 || Subject to modifications. Please note that some products may not be available in all countries. For more detailed information, please consult with your contact partner or directly with Richard Wolf GmbH.

arthro
line Punch / Scissors Punch



ARTHROline	Jaw section (Height x width)	Cut width	WL	Straight	Retrograde cutting	Jaw section curved upward	Product no.
Scissors punch W 2.4mm H 2.1 mm  Sectional view: 	2.1 x 2.4 mm	0.9 mm	120 mm	●			89140.0505
Scissors punch W 2.4mm H 2.1 mm  Sectional view: 					●		89140.0502
Punch W 5.7mm H 4mm retrograde left-cutting  Sectional view: 	4.0 x 5.7 mm	2.3 mm		●	left		89140.0605
Punch W 5.7mm H 4mm retrograde right-cutting  Sectional view: 				●	right		89140.0602



V1121 || Subject to modifications. Please note that some products may not be available in all countries. For more detailed information, please consult with your contact partner or directly with Richard Wolf GmbH.

Suction Punch / Suction Grasping Forceps with Integrated Suction Channel



Knee

1.2



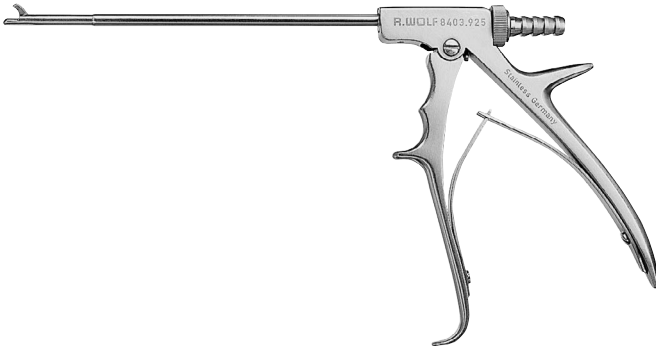







With integrated suction channel	Ø	WL	Product no.
Suction punch Ø 2.7mm  can be dismantled	2.7 mm	110 mm	89140.0027
Suction punch Ø 4.5mm  can be dismantled	4.5 mm		89140.0045



With integrated suction channel	Sheath Ø	WL	Product no.
Suction punch Ø 4.5mm straight 	4.5 mm	130 mm	8403.925
Suction grasping forceps straight 			8403.851

Hook Punch / Punch





	Jaw section (Height x width)	Cut width	WL	Straight	Curved to the left	Curved to the right	Sheath curved 15° upward	Jaw section curved upward	Product no.		
Hook punch Ø 3.4mm with shovel	3.4 x 3.4 mm	1.6 mm	130 mm	●					8488.951		
					●					8488.952	
						●					8488.953
Sectional view: 									●	●	8488.954
Hook punch Ø 3.4mm	3.4 x 3.4 mm	1.6 mm		●						8488.02	
									●		8488.025
Sectional view: 											
Hook punch Ø 3.4mm serrated	1.93 x 3.9 mm	2.7 mm		●						8488.121	
									●		8488.063
Sectional view: 											
Hook punch Ø 4.5mm with shovel, serrated	1.73 x 5.4 mm	3.4 mm						●			
										8489.063	
Sectional view: 											

Punch

Knee





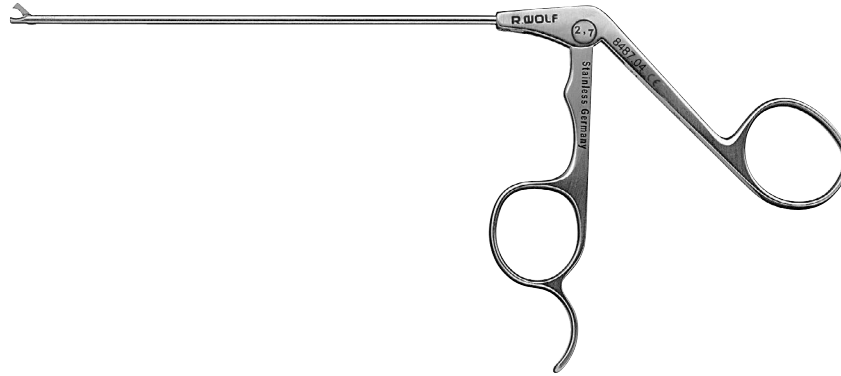

	Jaw section (Height x width)	Jaw section deflection	Cut width	WL	Product no.
Punch Ø 3.4mm front- and side-cutting  Sectional view: <input type="checkbox"/>	2.2 x 5.3 mm	90° left	3.4 mm	130 mm	8404.017
		90° right			8404.018
Hook punch with shovel Ø 3.4mm  Sectional view: <input type="checkbox"/>	2.1 x 2.0 mm	45° left	1.7 mm		8404.71*
		45° right			8404.81*

* particularly suitable for lateral cutting and smoothing

Scissors



	WL	Straight jaw section	Straight sheath	Sheath curved to the left	Sheath curved to the right	Product no.	
Hook scissors Ø 2.7mm 	130 mm	●	●			8487.04	
Hook scissors Ø 3.4mm 		●	●			8488.04	
Micro scissors Ø 3.4mm  Sectional view: 		●		●		8488.041	
		●			●		8488.042
		●	●				8488.051
			●		●		8488.052
			●			●	8488.053
	WL	Jaw section deflection	Straight sheath		Product no.		
Hook scissors Ø 3.4mm 	130 mm	45° left		●	8404.52		
		45° right		●	8404.62		

VI121 || Subject to modifications. Please note that some products may not be available in all countries. For more detailed information, please consult with your contact partner or directly with Richard Wolf GmbH.

Forceps

Knee

1.2

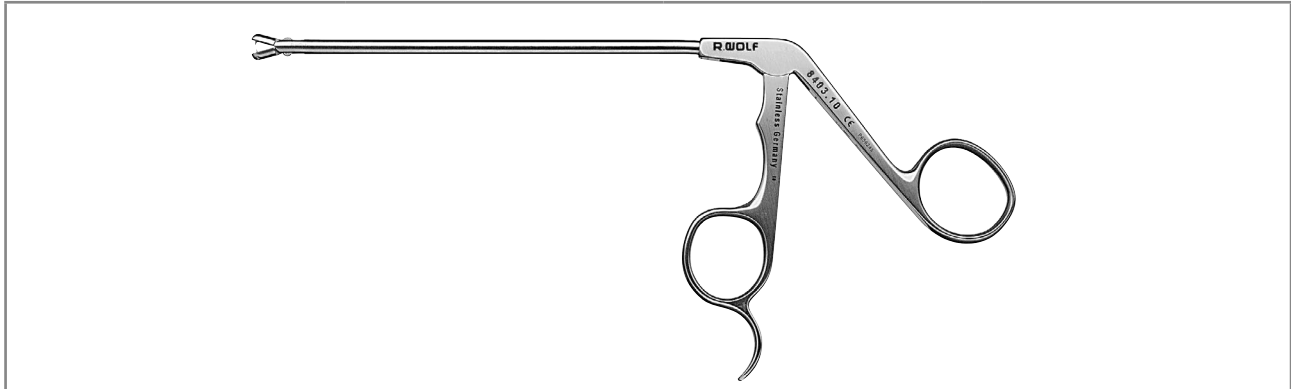

For retraction	Ø	WL	Product no.
Biopsy forceps with spike Ø 4.5mm smooth, double-action	4.5 mm	130 mm	8403.10

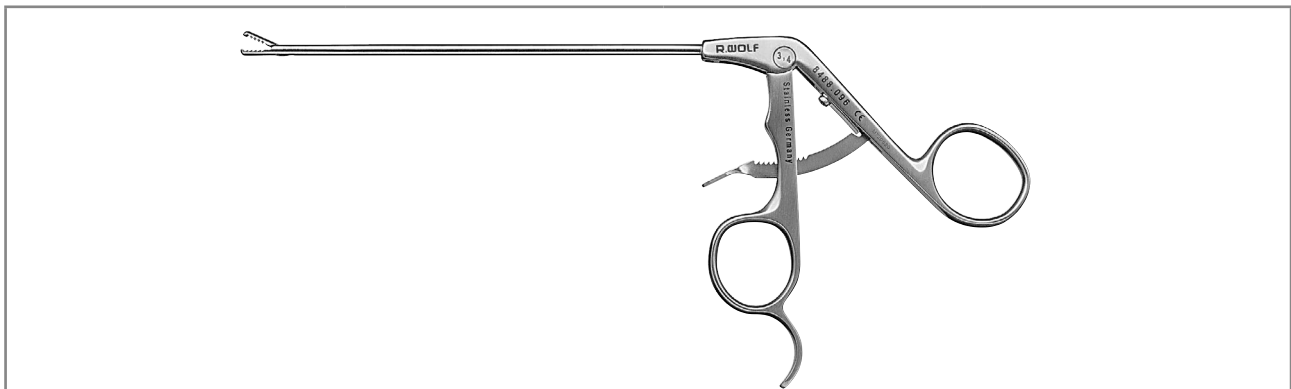

Handle with lock	Ø	WL	Product no.
Grasping forceps Ø 3.4mm straight jaw section, serrated	3.4 mm	130 mm	8488.096
Grasping forceps Ø 4.5mm straight jaw section, serrated	4.5 mm	134 mm	8489.096



Suture Grasping Forceps / Meniscus Grasping Forceps

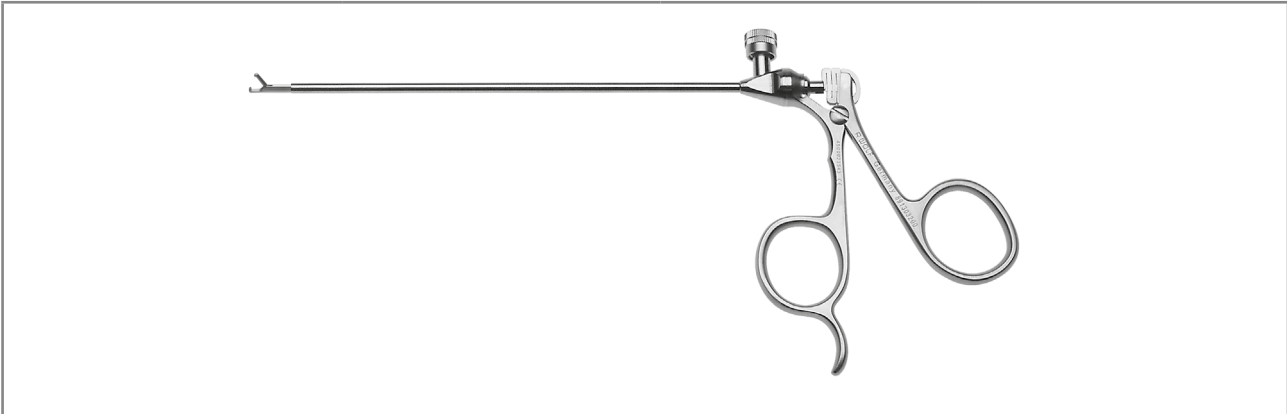

	Ø	WL	Product no.
Suture grasping forceps Ø 3.3mm Straight 	3.3 mm	160 mm	891303300

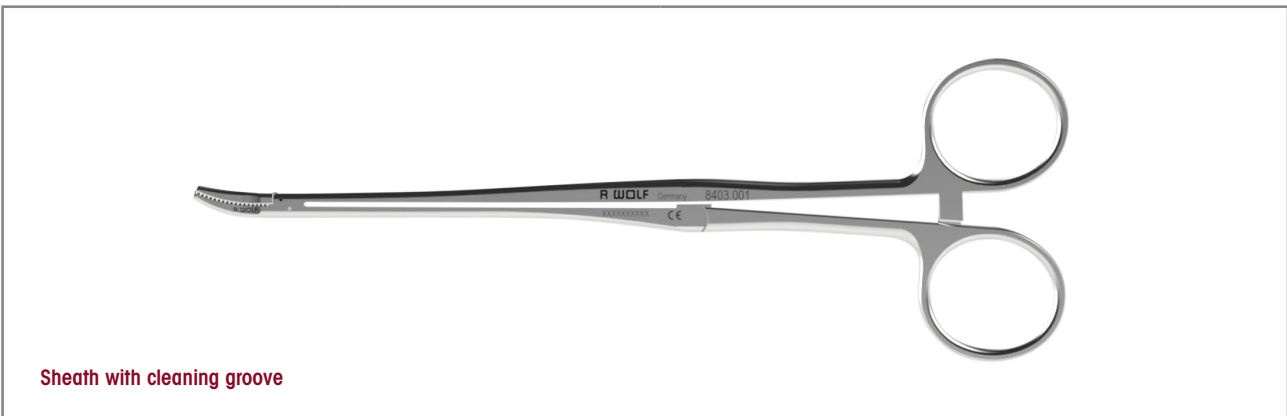

Sheath with cleaning groove





	Ø	WL	Product no.
Meniscus grasping forceps Ø 4/7mm with gripping tooth 	4 / 7 mm	105 mm	8403.00
Meniscus grasping forceps Ø 4/7 mm 			8403.001

Scalpel / Knife



Knee





1.2

	WL	Product no.
Straight scalpel WL 125mm 		8436.101
Rosette knife WL 125mm 		8436.151
Hook knife WL 125mm 	125 mm	8436.201
Banana knife WL 125mm 		8436.251
Straight arthro knife WL 125mm 		8436.301

Hand Instruments

Curette







	Ø	WL	Product no.
 Curette square Ø 4.5mm WL 170mm double-blade and curved upward	4.5 mm	170 mm	891632245
 Curette square Ø 5mm WL 170mm double-blade and curved upward	5.0 mm		891632260
 Curette round Ø 4.8mm WL 170mm double-blade and curved upward	4.8 mm		891631255
 Curette round Ø 6.3mm WL 170mm double-blade and curved upward	6.3 mm		891631270

Hand Instruments

Curette

Knee

1.3











		Inner Ø	WL	Product no.
<p>Curette, round Ø 3mm WL 95mm</p> <p>sharp at one end, curved upward, forward cutting</p> 		3.0 mm	95 mm	8435.901
<p>Curette, round Ø 4.5mm WL 95mm</p> <p>sharp at one end, curved upward, forward cutting</p> 		4.5 mm		8435.902
<p>Curette, round Ø 6mm WL 95mm</p> <p>sharp at one end, and curved upward, forward cutting</p> 		6.0 mm		8435.903
<p>Curette, round Ø 9mm WL 95mm</p> <p>sharp at one end, and curved upward, forward cutting</p> 		9.0 mm		89160.1009



Hand Instruments

Microfractor







	Deflection	WL	Product no.
Microfractor WL 170mm 15°	 Curved 15°	170 mm	891631521
Microfractor WL 170mm 30°	 Curved 30°		891633021
Microfractor WL 170mm 45°	 Curved 45°		891634521
Microfractor WL 170mm 35°	 35° S-shaped		891633522
Microfractor WL 170mm 60°	 Curved 60°		891636021
Microfractor WL 170mm 60°	 60° S-shaped		891636022
Microfractor WL 170mm 80°	 Curved 80°		891638021
Microfractor WL 65mm 30°	 Curved 30°	65 mm	891643011
Microfractor WL 65mm 45°	 Curved 45°		891644511
Microfractor WL 65mm 60°	 Curved 60°		891646011

VI121 || Subject to modifications. Please note that some products may not be available in all countries. For more detailed information, please consult with your contact partner or directly with Richard Wolf GmbH.

Hand Instruments

Cartilage File, Spoon, Curette



	Version	WL	Product no.
<p>Cartilage file straight WL 125mm W 6.25mm</p>  <p>rough</p>	Straight	125 mm	8436.501
<p>Cartilage file convex WL 125mm W 6.25mm</p>  <p>rough</p>	Convex		8436.511
<p>Cartilage file concave WL 125mm W 6.25mm</p>  <p>W 6.25 mm, rough</p>	Concave		8436.521
<p>Spoon Ø 6.5 x 10mm WL 125mm</p>  <p>rough</p>	Curved		8436.601
<p>Curette round Ø 5mm WL 125mm</p>  <p>double-blade</p>	Angled		8436.701

Knee

1.4

ACL Hammer

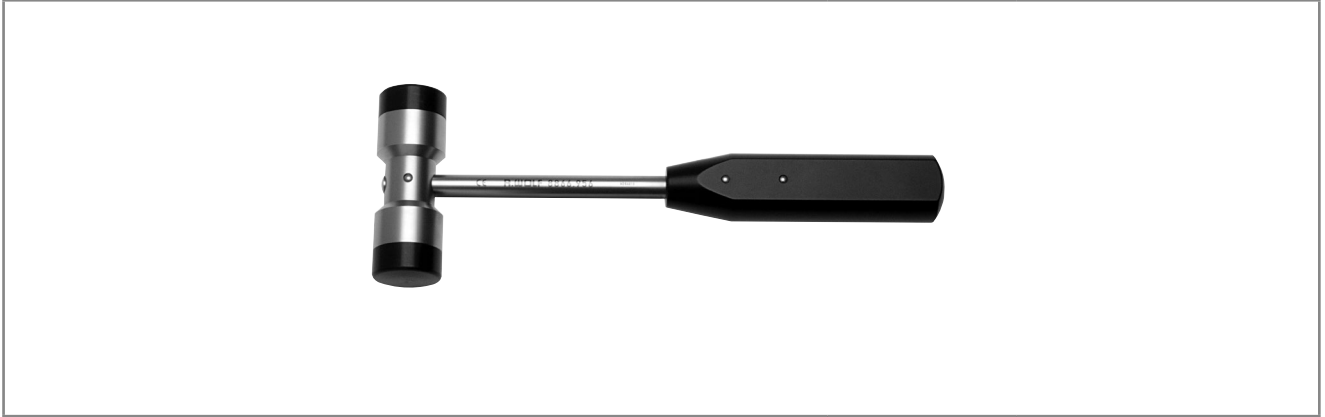

	TL	Product no.
ACL hammer TL 248mm	248 mm	8866.956

Knee
1.4

VI121 || Subject to modifications. Please note that some products may not be available in all countries. For more detailed information, please consult with your contact partner or directly with Richard Wolf GmbH.

graft^{line}

Instrument System

for arthroscopic cruciate ligament surgery



Modular concept

The system's outstanding performance is provided by its unparalleled diversity and universality. **Graftline** offers highly specialized – and in some cases patented – technology for a huge range of surgical options.

- **Efficiency goes hand in hand.** Minimal handles and intuitive connection options for all instruments save on space and weight.
- **ACL and PCL in one instrument.** **Graftline** provides the instruments for anterior and posterior cruciate ligament plastic surgery in intelligent combinations.
- **Well prepared for optimum grip.** With the Graftline instruments and implants, the surgeon is perfectly prepared for all eventualities, for example, if ruptures occur.

A choice of fixing options

Graftline allows the ideal fixation method to be selected for the cruciate ligament graft, without the need for major adjustments. We offer a tried-and-tested range of fixing implants.

Unique perspectives

Graftline gives surgeons access to all methodological channels – from standard techniques to innovative specific solutions. BTB, BT grafts, hamstrings, allografts, oval tunnel technique, and hollow-burr technique: one system – a wealth of possibilities.

Removal of an Autologous Tendon

Semitendinosus Tendon and/or Gracilis Tendon

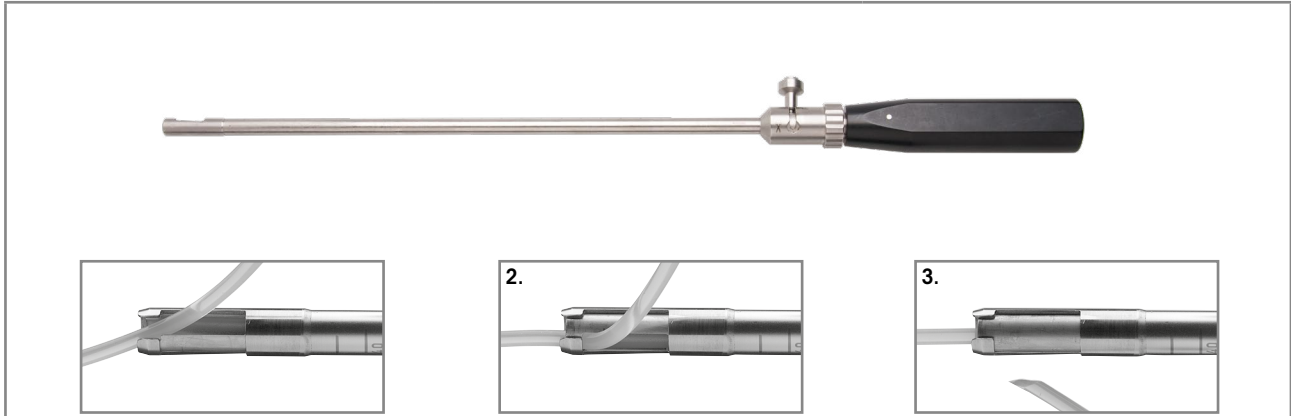

1. Retract		2. Secure		3. Sever	
		Ring Ø	WL	Product no.	
<p>Tendon stripper, universal 300mm, SZ8 mm</p>  <p>by Pässler</p> <ul style="list-style-type: none"> Universal use: open / closable / cutting function Blunt distal end Can be disassembled 		8.0 mm	300 mm	8866.951	

		Ring Ø	WL	Product no.	
<p>Tendon stripper standard Ø 7mm</p>  <ul style="list-style-type: none"> Closed Sharp distal end 		8.0 mm	300 mm	891610070	

Removal of an Autologous Tendon

Quadriceps or patellar tendon



		Inner Ø	Outer Ø	WL	Product no.
Hollow burr SZ 8	<ul style="list-style-type: none"> For efficient removal of the bone blocks for BT or BTB transplants when using the quadriceps or patellar tendon for application with the bee-system II oscillating ream machine F-31-700-00 	8,4 mm	9,4 mm	90 mm	8869.841
Hollow burr SZ 9		9,4 mm	10,4 mm		8869.843
Hollow burr SZ 10		10,4 mm	11,4 mm		8869.844



		Inner Ø	Outer Ø	WL	Product no.
Hollow drill bit SZ 8	<ul style="list-style-type: none"> for application with the bee-system II oscillating ream machine F-31-700-00 	7,4 mm	8,5 mm	185 mm	8869849
Hollow drill bit SZ 9		8,4 mm	9,5 mm		8869.851
Hollow drill bit SZ10		9,4 mm	10,5 mm		8869.852

Removal of an Autologous Tendon

Quadriceps or patellar tendon



		Inner Ø	Outer Ø	WL	Product no.
Bone elevator SZ 8		8,4 mm	11,1 mm	130 mm	8868.921
Bone elevator SZ 9	<ul style="list-style-type: none"> Release the bone blocks from the patella after using the hollow burrs different diameters to remove the bones blocks 	9,4 mm	11,2 mm		8868.922
Bone elevator SZ 10		10,5 mm	12,5 mm		8868.923







		Outer Ø	WL	Product no.
Suture puller WL 350mm	<ul style="list-style-type: none"> Passing the threads to pull in the transplant into the hollow burrs 	4 mm	350 mm	8869.921

graft^{line}

Graft Fixation



Implant-free press-fit fixation for patella or quadriceps tendon

			
		WL	Product no.
	for transfibial use	110 mm	8869.991
Curved plunger WL 110mm			







			
		WL	Product no.
	for use via the anteromedial portal	110 mm	8869.993
Pusher straight WL 110mm			

Knee
1.5

		Product no.
	Preparation table. tendon prep. bndl consisting of: Preparation table (88669023) Preparation plate (8866905) Transplant template SZ 5-13mm (8866953) Clamp insert (8866962) Hook clamp (8866935) Parallel screw clamp (8866961) RIWObutton interface (8866969) Tendon transplantat BT / BTB 6mm (8866966) Tendon transplantat BT / BTB 8mm (8866968) Leading hook (8866936)	88669700
	Preparation table (LxWxH) 390 mm x 190 mm x 6 mm	88669023
	Preparation plate (LxB) 380 mm x 60 mm	8866905
	Transplant template SZ 5-13mm oval-shaped tunnels D 5 x 10, D 6 x 12, D 7 x 14	8866953
	Clamp insert	8866962
	Hook clamp	8866935
	Parallel screw clamp	8866961
	RIWObutton interface	8866969
	Tendon transplantat BT / BTB 6mm	8866966
	Tendon transplantat BT / BTB 8mm	8866968
	Leading hook	8866936



	With coupling	Inner Ø	Product no.
 <p>Modular handle I-shaped cannulated</p>	●	3.5 mm	893011135
 <p>Modular handle impact / deflection plate cannulated</p>		3.5 mm	893011136
 <p>Handle I-shaped ID 3.2mm cannulated</p>		3.2 mm	893011132
 <p>Modular handle, t-shaped cannulated</p>		4.0 mm	893011137

VII/21 || Subject to modifications. Please note that some products may not be available in all countries. For more detailed information, please consult with your contact partner or directly with Richard Wolf GmbH.



 <p style="text-align: center;">891013 050/060/070/080/510/612/714</p>  <p style="text-align: center;">891014 070/080/090/100</p>						
ACL		Size	Color coding	∅	WL	Product no.
 cannulated, for the anteromedial portal	ACL aiming device SZ 5mm	5 mm	blue	2.5 mm	120 mm	891013050
	ACL aiming device SZ 6mm	6 mm	green			891013060
	ACL aiming device SZ 7mm	7 mm	red			891013070
	ACL aiming device SZ 8mm	8 mm	none			891013080
 cannulated, for the anteromedial portal	ACL aiming device SZ 5x10mm	oval 5 x 10 mm	blue	2.5 mm	120 mm	891013510
	ACL aiming device SZ 6x12mm	oval 6 x 12 mm	green			891013612
	ACL aiming device SZ 7x14mm	oval 7 x 14 mm	red			891013714
 cannulated, for the transtibial portal	ACL aiming device AT SZ 5mm	5 mm	blue	2.5 mm	120 mm	891015050
	ACL aiming device AT SZ 6mm	6 mm	green			891015060
	ACL aiming device AT SZ 7mm	7 mm	red			891015070
PCL						
 cannulated, for the anteromedial portal	PCL aiming device AL SZ 7mm	7 mm	red	2.5 mm	120 mm	891014070
	PCL aiming device AL SZ 8mm	8 mm	none			891014080
	PCL aiming device AL SZ 9mm	9 mm	yellow			891014090
	PCL aiming device AL SZ 10mm	10 mm	white			891014100

● For use with the modular handles

UniCracker





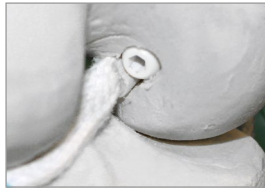

For use with the modular handles		WL	Product no.
 <p>Univ. tunnel notcher Ø 4–9 mm WL 130mm</p>	<p>Impacting chisel for indentation of the tunnel from Ø 4 to 9 mm, cannulated 2.5 mm</p>	130 mm	891611110

For use with the modular handles		WL	Product no.
 <p>Notch chisel WL 130mm one-sided grinding cannulated, Ø 2.5 mm</p>	<p>Gentle graft fixation when using interference screws</p>	130 mm	891511000



		WL	Product no.
 <p>Tunnel probe WL 140 mm graduated</p>	<p>For determining the length of the femoral tunnel – particularly when using the RIWObutton to determine the loop length</p>	140 mm	891510012

Preparing the Femoral Tunnel



Instruments for preparing oval tunnels



For use with the modular handles			Size	Color coding	WL	Product no.
 Tunnel rasp oval, cannulated Ø 2.5 mm	Tunnel rasp Ø 5 x 10mm WL 130mm	For preparing the oval-shaped femoral tunnel on the joint side	5 x 10 mm	blue	130 mm	891611101
	Tunnel rasp Ø 6 x 12mm WL 130mm		6 x 12 mm	green		891611102
	Tunnel rasp Ø 7 x 14mm WL 130mm		7 x 14 mm	red		891611103

VI121 || Subject to modifications. Please note that some products may not be available in all countries. For more detailed information, please consult with your contact partner or directly with Richard Wolf GmbH.







For use with the modular handles			∅	WL	Product no.
 <p>Compactor cannulated ∅ 2.5 mm graduated</p>	Compactor SZ 8	Compacting the spongiosa during simultaneous, asymmetric formation of the femoral tunnel using a compactor head flattened at the side. For the positioning and press-fit anchorage of bone plugs for BT and BTB grafts. ● For use with the modular handles	8.0	290 mm	891511708
	Compactor SZ 9		9.0		891511709
	Compactor SZ 10		10.0		891511710
Also:					
	Deflection sleeve	For removal of compactors			8868.992
	Tunnel stopper	For the direct closure of tibial drill holes			8868.941



VII/21 || Subject to modifications. Please note that some products may not be available in all countries. For more detailed information, please consult with your contact partner or directly with Richard Wolf GmbH.

Single bundle ACL reconstruction



	Adjustable alignment device bndl consisting of:	Product no.	Product no.bndl	
			8874.013	8874.014
	Base section for standard tibial, graduated for alignment hook and spoon and for drill guide	8874.113	●	●
	Aiming spoon tibial ACL	8874.123		●
	Aiming hook tibial ACL	8874.121	●	
	Alignment wire guide standard SZ 2.5	8874.131	●	●

Double-bundle ACL reconstruction

		Product no.
	Alignment ARC ZG tibial ACL right For the double-bundle technique on the right knee	8874130
	Zielbügel ZG Tibial ACL links DB For the double-bundle technique on the left knee	88741301

PCL reconstruction

		Product no.
	Aiming spoon ZG tibial	8874129



Knee
1.5

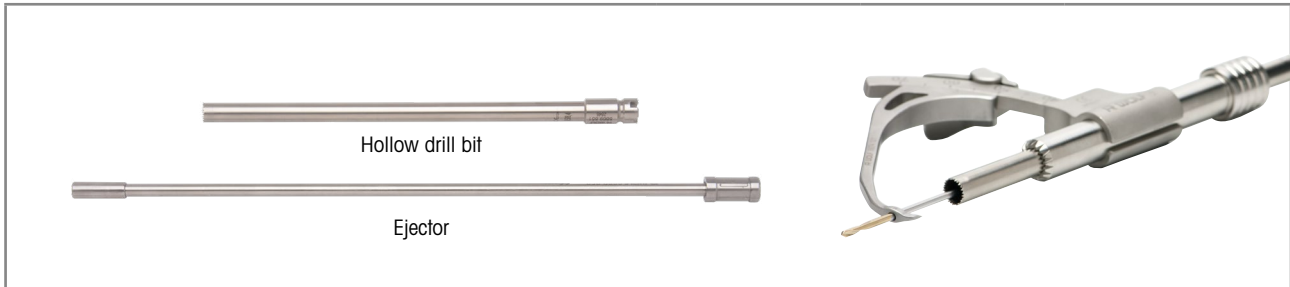

Preparing the Tibial Tunnel

Hollow drill extension set for harvesting bone cylinders







Hollow drill bit and Ejector	Inner Ø	Outer Ø	WL	Product no.
Hollow drill bit SZ 8	8,5 mm	7,4 mm	185	8869849
also: Ejector SZ 8				8869850
Hollow drill bit 9	9,5 mm	8,4 mm	185 mm	8869.851
also: Ejector SZ 9				8869.852
Hollow drill bit 10	10,5 mm	9,4 mm	185 mm	8869.853
also: Ejector SZ 10				8869.854

Base section, aiming spoon and aiming hook		Product no.
	Base section for tibial drill graduated	8874.111
	Aiming hook tibial ACL	8874.121
	Aiming spoon tibial ACL	8874.123

Alignment wire guide hollow drill SZ 2.5		Product no.
	Alignment wire guide hollow drill SZ 2.5 for use with base section 8874.111	8874.151
	Drill guide for hollow drill bit SZ 8 for use with base section 8874.111 and hollow drill bit 8869849 SZ 8	8874150
	Drill guide for hollow drill bit SZ 9 for use with base section 8874.111 and hollow drill bit 8869.851 SZ 9	8874.152
	Drill guide for hollow drill bit SZ 10 for use with base section 8874.111 and hollow drill bit 8869.853 SZ 10	8874.153





VI121 || Subject to modifications. Please note that some products may not be available in all countries. For more detailed information, please consult with your contact partner or directly with Richard Wolf GmbH.

		WL	Ø	Product no.
				
  Cross impactor with distal cross profile cannulated For alignment wire / Kirschner wire Ø 2.5 mm	Cross impactor Ø 5mm WL 150mm	150 mm	5,0 mm	891511005
	Cross impactor Ø 5.5mm WL 150mm		5,5 mm	891511055
	Cross impactor Ø 6.0mm WL 150mm		6,0 mm	891511006
	Cross impactor Ø 6.5mm WL 150mm		6,5 mm	891511065
	Cross impactor Ø 7.0mm WL 150mm		7,0 mm	891511007
	Cross impactor Ø 7.5mm WL 150mm		7,5 mm	891511075
	Cross impactor Ø 8.0mm WL 150mm		8,0 mm	891511008
	Cross impactor Ø 8.5mm WL 150mm		8,5 mm	891511085
	Cross impactor Ø 9.0mm WL 150mm		9,0 mm	891511009
	Cross impactor Ø 9.5mm WL 150mm		9,5 mm	891511095
	Cross impactor Ø 10.0mm WL 150mm		10,0 mm	891511010
	Cross impactor Ø 10.5mm WL 150mm		10,5 mm	891511105
	Cross impactor Ø 11.0mm WL 150mm		11,0 mm	891511011
also:				
	Modular handle, t-shaped with coupling, cannulated			893011137

graft^{line}

Preparing the Tibial Tunnel

Cannulated head drill

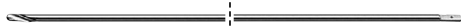
		WL	Ø	Product no.
  Head drill cannulated, Ø 2.65 mm TiN coating For alignment wire / Kirschner wire Ø 2.5 mm	Head drill Ø 4.5mm	145 mm	4.5 mm	89960.1045
	Head drill Ø 5mm		5.0 mm	89960.1050
	Head drill Ø 5.5mm		5.5 mm	89960.1055
	Head drill Ø 6mm		6.0 mm	89960.1060
	Head drill Ø 6.5mm		6.5 mm	89960.1065
	Head drill Ø 7mm		7.0 mm	89960.1070
	Head drill Ø 7.5mm		7.5 mm	89960.1075
	Head drill Ø 8mm		8.0 mm	89960.1080
	Head drill Ø 8.5mm		8.5 mm	89960.1085
	Head drill Ø 9mm		9.0 mm	89960.1090
	Head drill Ø 9.5mm		9.5 mm	89960.1095
	Head drill Ø 10mm		10.0 mm	89960.1010
	Head drill Ø 10.5mm		10.5 mm	89960.1910
	Head drill Ø 11mm		11.0 mm	89960.1011
	Head drill Ø 11.5mm		11.5 mm	89960.1911
Head drill Ø 12mm	12.5 mm	89960.1012		
Head drill Ø 12.5mm	12.5 mm	89960.1912		
Head drill Ø 13mm	13.0 mm	89960.1013		
 Kirschner alignment wire Ø 2.5mm triangular grinding		TL 300 mm without suture eyelet	2.5 mm	89120.3025
 Kirschner alignment wire Ø 2.5mm spiral grinding		TL 310 mm without suture eyelet	2.5 mm	89960.1025
 Kirschner alignment wire Ø 2.5mm spiral grinding		TL 430 mm with suture eyelet	2.5 mm	89960.1125





graft*line*

Perforated Baskets for Instruments

Knee Arthroscopy

Sterilization – storage – transport

V1121 || Subject to modifications. Please note that some products may not be available in all countries. For more detailed information, please consult with your contact partner or directly with Richard Wolf GmbH.

Illustration	Description	Product no.
 <p>Perf. basket – knee arthrosc. Basic set</p>	<p>Holds: knee arthroscopy basic set, for sterilization (steam and low-temperature), storage and transport, with instrument holders, inner dimensions (wxhxd): 513x134x233mm, outer dimensions (wxhxd): 549x150x250mm</p>	<p>33007</p>
 <p>Perf. basket – knee arthrosc. ACL/PCL 1</p>	<p>Holds: instrument set for knee arthroscopy ACL/PCL 1, for sterilization (steam and low-temperature), storage and transport, with instrument holders, inner dimensions (wxhxd): 513x134x233mm, outer dimensions (wxhxd): 549x150x250mm</p>	<p>33008</p>
 <p>Perf. basket – knee arthrosc. ACL/PCL 2</p>	<p>Holds: instrument set for knee arthroscopy ACL/PCL 2, f for sterilization (steam and low-temperature), storage and transport, with instrument holders, inner dimensions (wxhxd): 513x134x233mm, outer dimensions (wxhxd): 549x150x250mm</p>	<p>33009</p>
 <p>Perf. basket For knee arthrosc. prep tab</p>	<p>Holds: knee arthroscopy preparation table, for sterilization (steam and low-temperature), storage and transport, with instrument holders, inner dimensions (wxhxd): 513x134x233mm, outer dimensions (wxhxd): 549x150x250mm</p>	<p>33010</p>

passend für Standard Container (1 STE = 1 Sterilguteinheit)

Knee
1.5

graft^{line}

Graft Fixation

Tendon anchor / RIWObutton

Tendon anchor		Size	Product no.
T-Lock OSTEOTRANS 	T-Lock OSTEOTRANS tendon anchor, sterile	6	OLRA-6
		7	OLRA-7
		8	OLRA-8
		9	OLRA-9

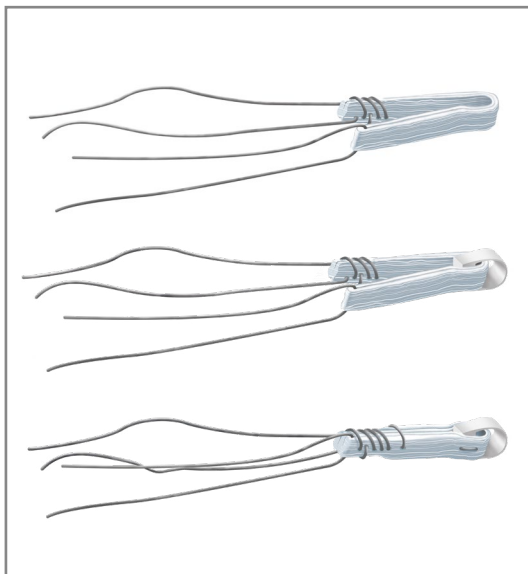

BioactIF OSTEOTRANS

"OK" interference screws



	Thread Ø	Length	Hole	Product no.
BioactIF OSTEOTRANS 7 X 25, sterile	/ mm	25 mm	2,2 mm	OK0725A
BioactIF OSTEOTRANS 7 X 30, sterile		30 mm		OK0730A
BioactIF OSTEOTRANS 8 X 25, sterile	8 mm	25 mm		OK0825
BioactIF OSTEOTRANS 8 X 30, sterile		30 mm		OK0830
BioactIF OSTEOTRANS 9 X 25, sterile	9 mm	25 mm		OK0925
BioactIF OSTEOTRANS 9 X 30, sterile		30 mm		OK0930



Screwdriver	For interference screws with thread size	Product no.
 <p>Screwdriver OK/BK SZ 7 -11mm cannulated, color code red, graduated</p>	7-11 mm	891800030



Thread cutter	For OK screws	Product no.	
	Thread cutter for OK screws SZ 7 mm	Size 7 mm	891800700
	Thread cutter for OK screws SZ 8 mm	Size 8 mm	891800800
	Thread cutter for OK screws SZ 9 mm	Size 9 mm	891800900



Guide wire	Ø	TL	Product no.
 <p>Nitinol guide wire Ø 1.2mm</p>	1.2 mm	350 mm	89120.2012

graft^{line}

Graft Fixation

Bioactive and bioresorbable interference screws
"BK-Serie"

Bioact^{IF} OSTEOTRANS

"BK" interference screws





	Thread Ø	Length	Hole	Product no.
BioactIF OSTEOTRANS 6 X 20, sterile	6 mm	20 mm	1.7 mm	BK0620
BioactIF OSTEOTRANS 7 X 20, sterile		20 mm		BK0720
BioactIF OSTEOTRANS 7 X 25, sterile		25 mm		BK0725
BioactIF OSTEOTRANS 7 X 30, sterile	30 mm	BK0730		
BioactIF OSTEOTRANS 8 X 20, sterile	8 mm	20 mm		BK0820
BioactIF OSTEOTRANS 8 X 25, sterile		25 mm		BK0825
BioactIF OSTEOTRANS 8 X 30, sterile		30 mm		BK0830
BioactIF OSTEOTRANS 9 X 20, sterile	9 mm	20 mm		BK0920
BioactIF OSTEOTRANS 9 X 25, sterile		25 mm		BK0925
BioactIF OSTEOTRANS 9 X 30, sterile		30 mm		BK0930
BioactIF OSTEOTRANS 10 X 25, sterile	10 mm	25 mm	BK1025	
BioactIF OSTEOTRANS 10 X 30, sterile		30 mm	BK1030	

891800020



891800030



Screwdriver		for interference screws with thread size	Product no.
	Screwdriver BK SZ 6MM cannulated, color code black, graduated	6 mm	891800020
	Screwdriver OK/BK SZ 7 -11mm cannulated, color code red, graduated	7-11 mm	891800030

Guide wire



Nitinol guide wire
Ø 1.2mm

Ø

1.2 mm

TL

350 mm

Product no.

89120.2012

graft^{line}

Graft Fixation

Bioactive and bioresorbable interference screws

"RK-Serie"

Bioact^{IF} OSTEOTRANS

"RK" interference screws





conical, absorbable, sterile	Thread Ø	Length	Hole	Product no.
Bioactif OSTEOTRANS OD 6mm L 20mm	6 mm	20 mm	1,5 mm	RK0620
Bioactif OSTEOTRANS OD 7mm L 20mm	7 mm	20 mm		RK0720
Bioactif OSTEOTRANS OD 7mm L 25mm		25 mm		RK0725
Bioactif OSTEOTRANS OD 7mm L 30mm		30 mm		RK0730
Bioactif OSTEOTRANS OD 8mm L 20mm	8 mm	20 mm		RK0820
Bioactif OSTEOTRANS OD 8mm L 25mm		25 mm		RK0825
Bioactif OSTEOTRANS OD 8mm L 30mm		30 mm		RK0830
Bioactif OSTEOTRANS OD 9mm L 20mm	9 mm	20 mm		RK0920
Bioactif OSTEOTRANS OD 9mm L 25mm		25 mm		RK0925
Bioactif OSTEOTRANS OD 9mm L 30mm		30 mm		RK0930
Bioactif OSTEOTRANS OD 10mm L 25mm	10 mm	25 mm		RK1025

891800021



891800031





		for interference screws with thread size	Product no.
	Screwdriver RK SZ 5 -6mm cannulated, color code red, graduated	6 mm	891800021
	Screwdriver RK GR 7 -11mm cannulated, color code yellow, graduated	7 - 11 mm	891800031

graft^{line}

Graft Fixation

Guide Wire



Guide wire	Ø	TL	Product no.
 Nitinol guide wire Ø 1.2mm	1.2 mm	350 mm	89120.2012



Shoulder

Shoulder

1 Standard Equipment / Arthroscopes

2 ARTHROline Punches

3 Hook Probe / Marking Rod

4 Reconstructive Shoulder Arthroscopy

Basic Equipment

for shoulder arthroscopy

Product	Product no.	Quantity	Catalog / Section
Endoscopes and Instruments			
PANOVIEW telescope 30° Ø 4mm SL 170mm	8880.543	1	Orthopedics / Shoulder
Fiber light cable bndl, Ø 3.5mm, 2.3m long	806635231	1	Orthopedics / Shoulder
Sheath for arthroscope OD 6mm	89121.1260	1	Orthopedics / Shoulder
Obturator for arthroscope OD 5.5/6/6.3mm tip, semi-blunt	89121.0542	1	Orthopedics / Shoulder
Hook probe WL 115mm H 4.5mm graduated	8399.95	1	Orthopedics / Shoulder
ARTHROline punch W 4.6mm H 1.6mm jaws curved upward	89140.0102	1	Orthopedics / Shoulder
ARTHROline punch W 5.5mm H 1.6mm jaws curved upward, sheath curved to the left	89140.0103	1	Orthopedics / Shoulder
ARTHROline punch W 4.6mm H 1.6mm jaw section serrated, sheath curved upward	89140.0122	1	Orthopedics / Shoulder
ARTHROline hook punch W 4mm H 21.1mm straight jaw section	89140.0405	1	Orthopedics / Shoulder

Overview

Shoulder



2.1

arthro <i>lution</i>			Fingers, toes	Hand	Foot, elbow		Knee, shoulder, hip
Telescope Ø			1.9 mm	2.4 mm	2.7 mm		4.0 mm
Telescopes	30°	PANOVIEW telescope	8860453	8871413	8476.433	8672.422	8880.543
		PANOVIEW wide angle telescope					8885.443
	70°	PANOVIEW telescope					8880.545
		PANOVIEW wide angle telescope					8885.445
Sheath WL			40 mm	60 mm	77.5 mm	145 mm	130 mm
Sheaths	with 1 irrigation stopcock, fixed		891220124	891220132			
	with 2 irrigation stopcocks, fixed						89121.0260
	with 1 irrigation stopcock, rotatable					891241141	
	with 2 irrigation stopcocks, rotatable			891221232	891221241	891241241	89121.1260
	High-Flow with 1 irrigation stopcock, fixed		891220128				
	High-Flow with 2 irrigation stopcocks, rotatable			891221235			89121.1263
	Small-caliber with 2 irrigation stopcocks, rotatable						891221255
Obturator	blunt				891222754		89121.0544
	semi-blunt		891221952	891222452			89121.0542
	conical blunt				891222750	891242750	89121.0540
	sharp					891242761	89121.0640
	conical pointed		891221962	891222462	891222762		
Sealing part for sheath						891040000	

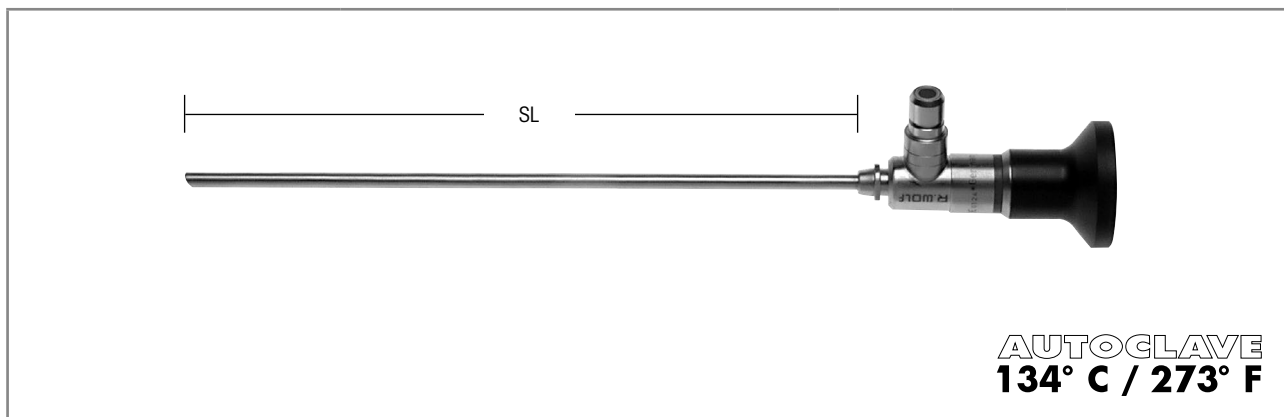
Arthroscope with PANOVIEW Telescope Ø 4 mm

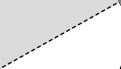

AUTOCLAVE
134° C / 273° F

Direction of view		SL	Ø	Product no.
	PANOVIEW telescope 0° Ø 4mm SL 170mm	170 mm	4.0 mm	8880.541
	PANOVIEW telescope 30° Ø 4mm SL 170mm			8880.543
	PANOVIEW telescope 45° Ø 4mm SL 170mm			8880.544
	PANOVIEW telescope 70° Ø 4mm SL 176mm	176 mm		8880.545

Recommended accessories		Product no.
Perf. basket for standard telescope 1	(L x B x H) 297 x 59 x 54 mm	38015
Fiber light cable bndl Comprising: Fiber light cable (80663523), adapter, projector to light cable (8095.07), and adapter, light cable to endoscope (809509)	Ø 3.5 mm, 2.3 m long	806635231

VI121 || Subject to modifications. Please note that some products may not be available in all countries. For more detailed information, please consult with your contact partner or directly with Richard Wolf GmbH.





Shoulder
2.1

arthro *lution* Sheath for Arthroscope

with automatic click-lock mechanism

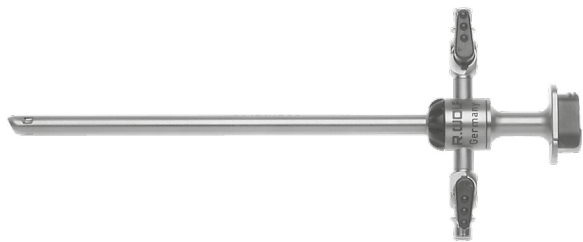
Shoulder

2.1

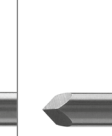







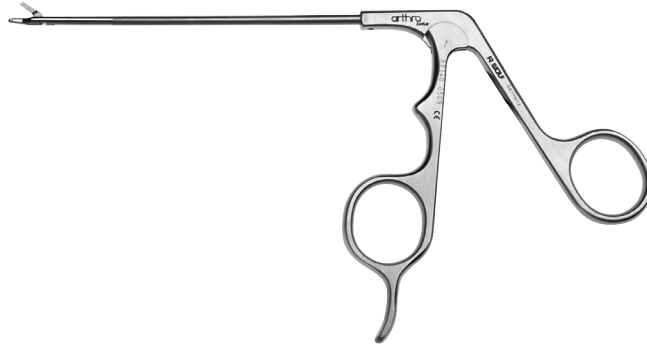

										
Sheath for arthroscope OD 6mm							Obturator for arthroscope 5.5/6/6.3mm blunt	Obturator for arthroscope 5.5/6/6.3mm semi-blunt	Obturator for arthroscope 5.5/6/6.3mm conical blunt	Trocାର tip, triangular SZ 4mm WL 176mm
High-Flow	Small-caliber	2 fixed stopcocks	2 rotatable stopcocks	Outer Ø	WL	Product no.				
		●		6.0 mm	132 mm	89121.0260	89121.0544	89121.0542	89121.0540	
			●	6.0 mm	130 mm	89121.1260				
●			●	6.3 mm	130 mm	89121.1263				
	●		●	5.5 mm	130 mm	891221255				

Spare parts	Product no.
Irrigation ring with 1 stopcock	150081761
Irrigation ring with 2 stopcocks	150081762
Stopcock insert, bundle, cap 3.0mm (PACK= 5 PCS) Also: Disassembly tool	896.0002 38310.0001
Mounting ring	15008.1704
Spare sealing comprising: O-rings, small / large, 5 of each Also: O-ring tool (disassembly tool)	15176.142 15106.230

Recommended accessories	Product no.
Sealing part for sheath	89101.0000
Marking rod Ø 4.0mm conical blunt TL 325 mm	8863.75

arthroline Punch





ARTHROline	Jaw section (Height x width)	Cut width	WL	Straight	Curved to the left	Sheath curved upward	Jaw section curved upward	Product no.		
Punch W 4.6mm H 1.6mm movable jaw section serrated  Sectional view: 	1.6 x 4.6 mm	3.3 mm	120 mm	●				89140.0105		
Punch W 4.6mm H 1.6mm movable jaw section serrated  Sectional view: 							●	89140.0102		
Punch W 4.6mm H 1.6mm movable jaw section serrated  Sectional view: 								●	89140.0122	
Punch W 5.5mm H 1.6mm movable jaw section serrated  Sectional view: 								●	●	89140.0101
Punch W 5.5mm H 1.6mm movable jaw section serrated  Sectional view: 									●	89140.0103

VI121 || Subject to modifications. Please note that some products may not be available in all countries. For more detailed information, please consult with your contact partner or directly with Richard Wolf GmbH.

Hook Probe / Marking Rod



	H	WL	Product no.
Hook probe WL 115mm H 7mm, graduated 	7.0 mm	115 mm	8399.901
Hook probe WL 115mm H 4.5mm, graduated 	4.5 mm		8399.95



	Ø	TL	Product no.
Hook probe TL 228 mm SZ 4.4mm 	4.4 mm	228 mm	8863.80



	Ø	TL	Product no.
Marking rod Ø 4.0mm conical blunt 	4.0 mm	325 mm	8863.75

Basic Instrument Set

for reconstructive shoulder arthroscopy

Product	Product no.	Quantity	Catalog / Section
Endoscopes and Instruments			
Knot pusher WL 170mm	89150.3000	1	Orthopedics / Shoulder
Suture catcher WL 160mm	89150.3003	1	Orthopedics / Shoulder
Concave rasp WL 175mm W 4.75mm	89160.3003	1	Orthopedics / Shoulder
Convex rasp WL 175 mm W 4.75mm	89160.3002	1	Orthopedics / Shoulder
Straight rasp WL 175mm W 4.75mm	89160.3005	1	Orthopedics / Shoulder
Knife angled 15° WL 160mm W 4.5mm	89160.3015	1	Orthopedics / Shoulder
Distally cutting knife WL 160mm W 4.5mm	89160.3001	1	Orthopedics / Shoulder
Suture cutter Ø 5mm WL 200mm	891603000	1	Orthopedics / Shoulder
Suture grasping forceps Ø 3.3mm	891303300	1	Orthopedics / Shoulder
Grasping forceps Ø 3.4mm	8488.096	1	Orthopedics / Shoulder
Marking rod Ø 4.0mm, conical blunt	8863.75	1	Orthopedics / Shoulder
ENDOSPIKE shoulder suture instrument Ø 5.3mm	891403000	1	Orthopedics / Shoulder
Also: Needles for suture forceps, sterile	491403000	1	Orthopedics / Shoulder
Perf. basket for shoulder arthroscopy	33012	1	Orthopedics / Shoulder

Endospike

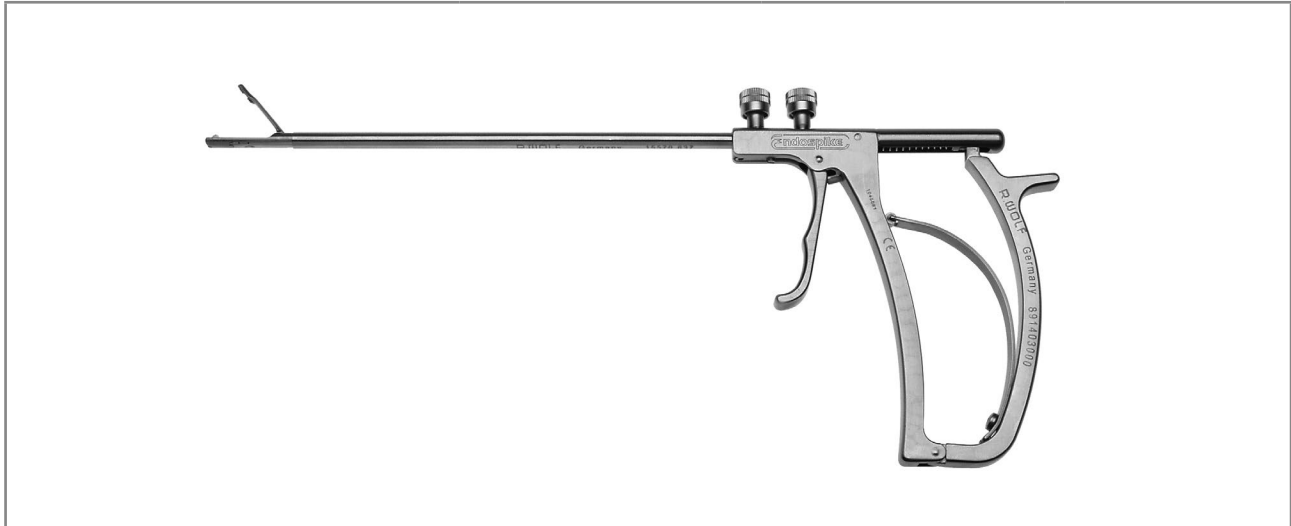

Shoulder Suture Instrument





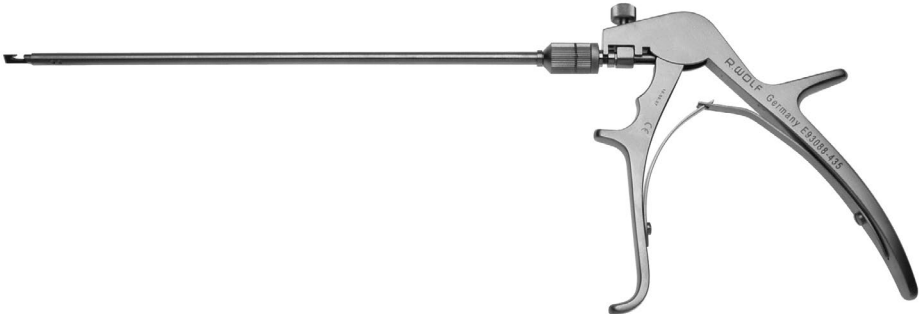

	Ø	WL	Product no.
<p>ENDOSPIKE shoulder suture instrument Ø 5.3mm</p>  <p>with irrigation connector, can be dismantled</p>	5.3 mm	169 mm	891403000
Also:			
<p>Needles for stitching forceps, sterile, disposable (PACK= 5 PCS)</p>			491403000



Shoulder
2.4

Suture Cutter / Suture Grasping Forceps

			
	Ø	WL	Product no.
 Suture cutter Ø 5mm WL 200mm can be dismantled	5.0 mm	200 mm	891603000

			
	Ø	WL	Product no.
 Suture grasping forceps Ø 3.3mm jaw section straight, sheath straight	3.3 mm	160 mm	891303300
 Suture grasping forceps Ø 3.3mm straight jaw section, pointed			891303200
 Suture grasping forceps Ø 3.3mm jaw section curved 45° upward, pointed			891303230

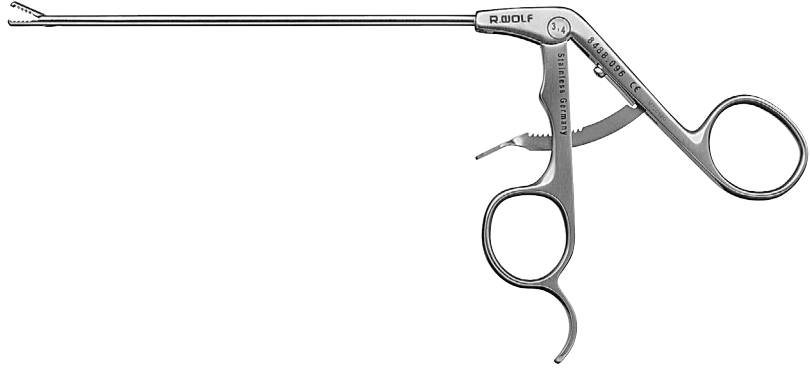
Grasping Forceps

			
	Ø	WL	Product no.
 Grasping forceps Ø 3.4mm straight jaw section, serrated, handle with lock	3.4 mm	130 mm	8488.096

Grasping forceps for holding and repositioning the rotator cuff.

Shoulder
2.4

Hand Instruments

		WL	Product no.
			
Knot pusher WL 170 mm 	For applying and tightening slip knots in arthroscopically applied sutures	170 mm	89150.3000
Suture catcher WL 160mm 	Hook eye for suture management	160 mm	89150.3003
Distally cutting knife WL 160mm W 4.5mm 	For loosening soft tissue from the glenoid edge	160 mm	89160.3001
Knife angled 15° WL 160mm W 4.5mm 			89160.3015
Convex rasp WL 175mm W 4.75mm  rough	For arthroscopic "freshening" of the bone at the glenoid in Bankart and SLAP lesions and of the greater tubercle in reconstruction of the rotator cuff	175 mm	89160.3002
Concave rasp WL 175mm W 4.75mm  rough			89160.3003
Straight rasp WL 175mm W 4.75mm  rough			89160.3005

VI121 || Subject to modifications. Please note that some products may not be available in all countries. For more detailed information, please consult with your contact partner or directly with Richard Wolf GmbH.

Sterilization Basket

for Instruments Used in Shoulder Arthroscopy

Sterilization – storage – transport

Illustration	Description	Product no.
 <p>Perf. Basket for shoulder arthroscopy</p> <p>also:</p> <p>Fixing ring Ø 50.39mm</p>	<p>Holds: instrument set for shoulder arthroscopy, for sterilization (steam and low-temperature), storage and transport, with instrument holders, inner dimensions (wxhxd): 513x95x233mm, outer dimensions (wxhxd): 538x117x250mm</p> <p>for perforated basket for flexible endoscopes, for fixing instruments during machine reprocessing, sterilization (steam and low-temperature), storage and transport, Ø 50,39x3,53mm, PACK=10 PCS</p>	<p>33012</p> <p>643301261</p>

Suitable for standard container

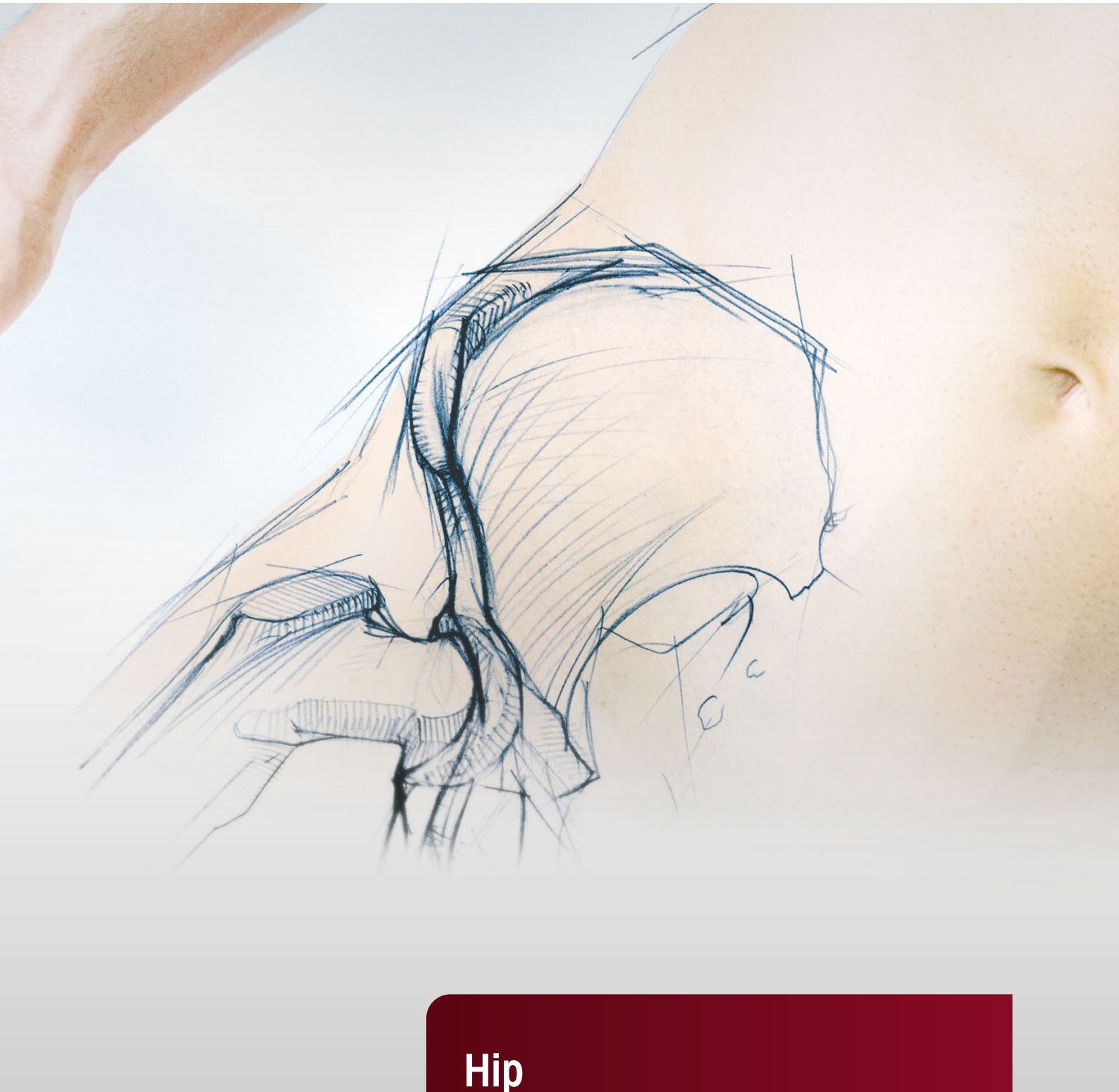

Hip

Hip

3.1

Arthrolution Arthroscopes Overview

3.2

Telescopes and Sheaths

3.3

Access Instruments

3.4

Dilation Systems

3.5

Irrigation Cannula

3.6

Aiming Device

3.7

Instruments

Overview

arthro <i>lution</i>			Fingers, toes	Hand	Foot, elbow		Knee, shoulder, hip
Telescope Ø			1.9 mm	2.4 mm	2.7 mm		4.0 mm
Telescopes	30°	PANOVIEW telescope	8860453	8871413	8476.433	8672.422	8880.543
		PANOVIEW wide angle telescope					8885.443
	70°	PANOVIEW telescope					8880.545
		PANOVIEW wide angle telescope					8885.445
Sheath WL			40 mm	60 mm	77.5 mm	145 mm	130 mm
Sheaths	with 1 irrigation stopcock, fixed		891220124	891220132			
	with 2 irrigation stopcocks, fixed						89121.0260
	with 1 irrigation stopcock, rotatable					891241141	
	with 2 irrigation stopcocks, rotatable			891221232	891221241	891241241	89121.1260
	High-Flow with 1 irrigation stopcock, fixed		891220128				
	High-Flow with 2 irrigation stopcocks, rotatable			891221235			89121.1263
	Small-caliber with 2 irrigation stopcocks, rotatable						891221255
Obturator	blunt				891222754		89121.0544
	semi-blunt		891221952	891222452			89121.0542
	conical blunt				891222750	891242750	89121.0540
	sharp					891242761	89121.0640
	conical pointed		891221962	891222462	891222762		
Sealing part for sheath						891040000	

VII/21 || Subject to modifications. Please note that some products may not be available in all countries. For more detailed information, please consult with your contact partner or directly with Richard Wolf GmbH.

COXARTIS

Telescope Ø 4 mm

for 4 mm arthroscopes

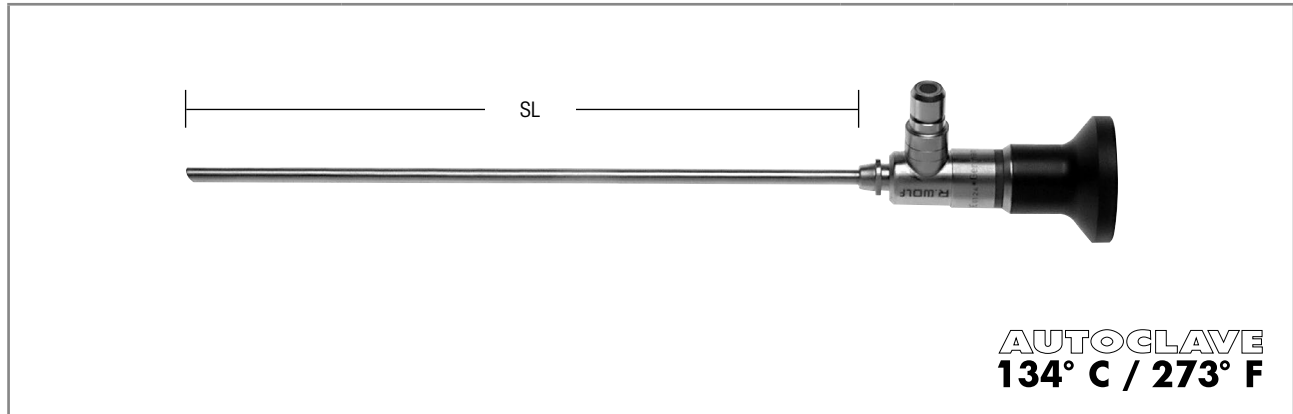

AUTOCLAVE
134° C / 273° F

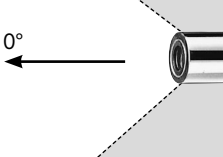
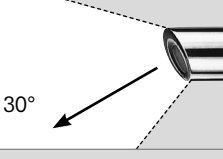
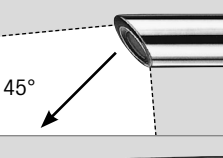
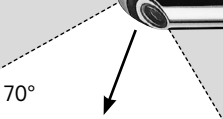

Direction of view		SL	Ø	Product no.
	PANOVIEW telescope 0° Ø 4mm SL 170mm	170 mm	4.0 mm	8880.541
	PANOVIEW telescope 30° Ø 4mm SL 170mm			8880.543
	PANOVIEW telescope 45° Ø 4mm SL 170mm			8880.544
	PANOVIEW telescope 70° Ø 4mm SL 171 mm	176 mm		8880.547



Recommended accessories		Product no.
Perf. basket for standard telescope 1	(L x B x H) 297 x 59 x 54 mm	38015
Fiber light cable bndl Comprising: Fiber light cable (80663523), adapter, projector to light cable (8095.07), and adapter, light cable to endoscope (809509)	Ø 3.5 mm, 2.3 m long	806635231

COXARTIS

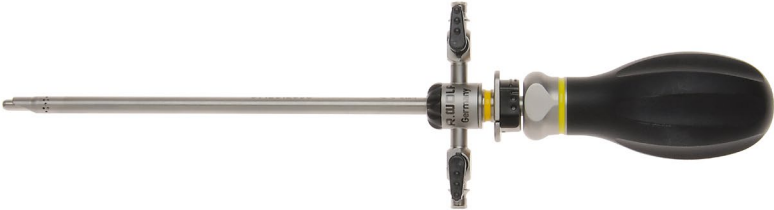
Sheath Ø 4 mm

for 4 mm arthroscopes

						
				2 rotatable stopcocks	Outer Ø	WL
ArthroLution sheath for arthroscope OD 6mm with automatic click-lock mechanism		●	6.0 mm	145 mm	8912312603	891234073
Also: Sealing part for sheath						89101.0000

						
				2 rotatable stopcocks	Outer Ø	WL
For continuous irrigation Comprising:						
ArthroLution sheath and outer sheath	ArthroLution sheath for arthroscope OD 5.3mm, with automatic click-lock mechanism		5.3 mm		8912312533	891234052
	Outer sheath for arthroscope OD 6.3mm	●	6.3 mm	130 mm	8912300633	
Also: Sealing part for sheath						89101.0000

COXARTIS

Telescope and Sheath Systems

for 4 mm arthroscopes, extra long

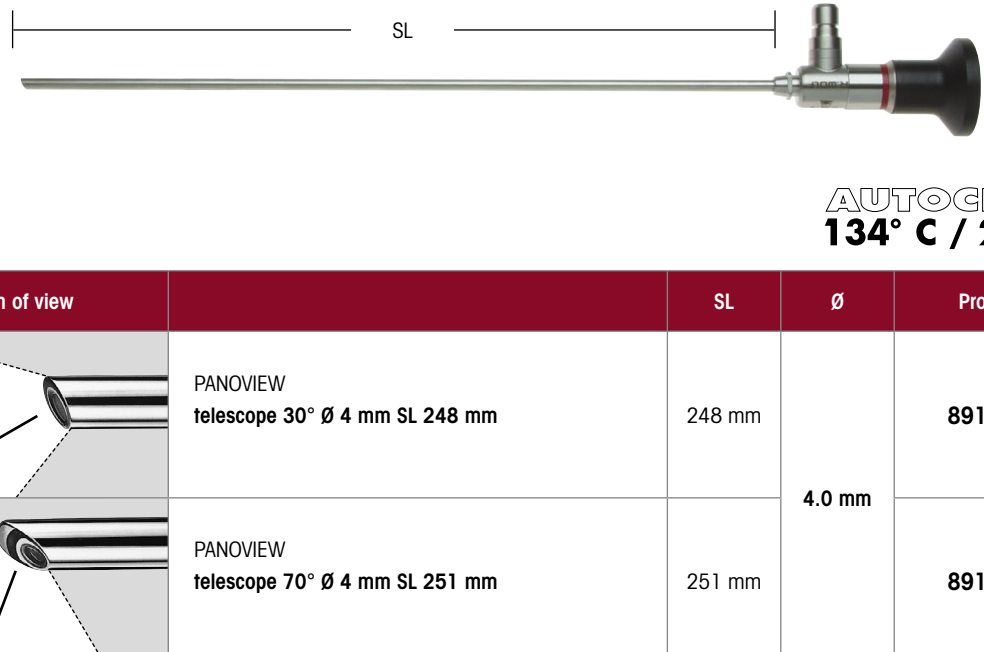

AUTOCLAVE
134° C / 273° F

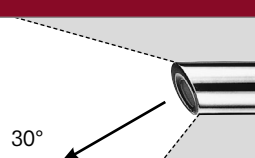
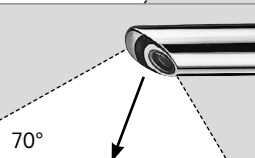
Direction of view		SL	Ø	Product no.
	PANOVIEW telescope 30° Ø 4 mm SL 248 mm	248 mm	4.0 mm	891134030
	PANOVIEW telescope 70° Ø 4 mm SL 251 mm	251 mm		891134070

Recommended accessories		Product no.
Perf. basket for standard telescope 1	(L x B x H) 297 x 59 x 54 mm	38015
Fiber light cable bndl Comprising: Fiber light cable (80663523), adapter, projector to light cable (8095.07), and adapter, light cable to endoscope (809509)	Ø 3.5 mm, 2.3 m long	806635231



	2 rotatable stopcocks	Outer Ø	WL	Product no.	Obturator for arthroscope OD 6 mm, cannulated, capacity 2 mm
ArthroLution sheath for arthroscope OD 6mm, with automatic click-lock mechanism	●	6.0 mm	145 mm	8912312607	891234077
Also: Sealing part for sheath					89101.0000

COXARTIS

Access Instruments

Cannula for punction, guide wire, marking rod

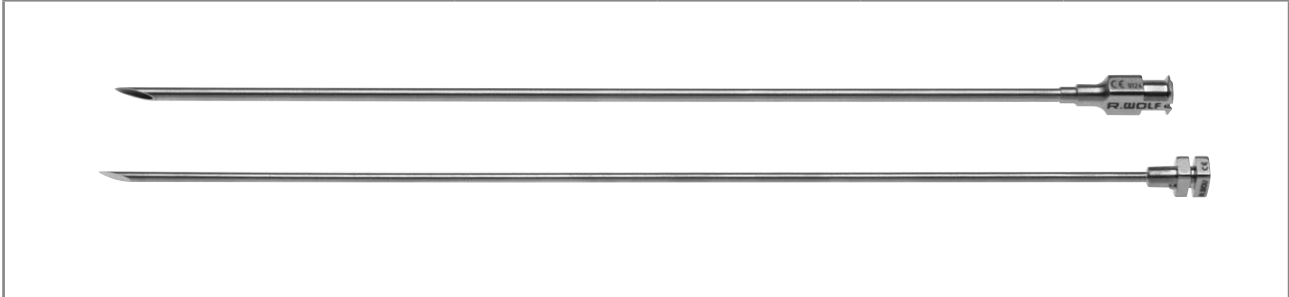

	Ø	Capacity	WL	Product no.
Cannula for punction Ø 2.6/2mm WL 200mm with internal needle, (PACK= 2 PCS)	2.6 mm	2.0 mm	200 mm	891732018



	Ø	TL	Product no.
Nitinol guide wire Ø 2mm (PACK= 2 PCS)	2.0 mm	450 mm	891534020

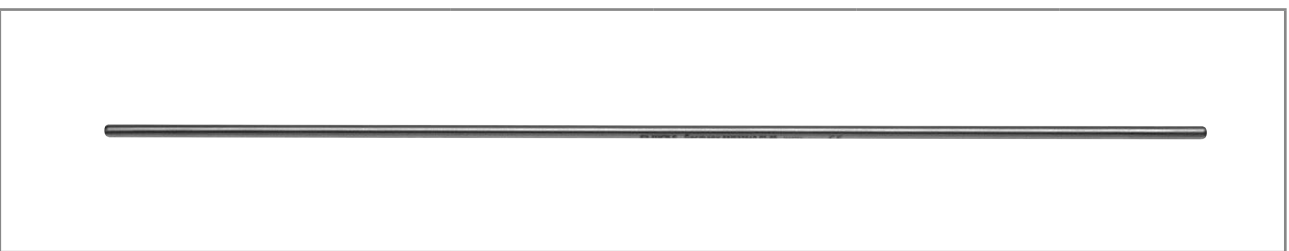

	Ø	Capacity	TL	Product no.
Marking rod Ø 4.0mm cannulated	4.0 mm	2.25 mm	325 mm	891532040
Marking rod Ø 4.0mm conical blunt	4.0 mm	-	325 mm	8863.75

V121 || Subject to modifications. Please note that some products may not be available in all countries. For more detailed information, please consult with your contact partner or directly with Richard Wolf GmbH.

COXARTIS

Access Instruments

Guide tube







	Ø	Capacity	WL	Product no.
Guide sheath slitted WL 120 mm SZ 7 mm slotted	2.6 mm	2 mm	200 mm	891237012
Obturator for guide tube cannulated			142 mm	891232070

COXARTIS

Access Instruments

Dilation system

 <p>891532050 / 891532070 / 891532090</p> <p style="text-align: right;">891530000</p>					
	Color coding	Ø	Capacity	WL	Product no.
Dilatator Ø 5mm WL 200mm  cannulated	green	5.0 mm	2.0 mm	200 mm	891532050
Dilatator Ø 7mm WL 200mm  cannulated	blue	7.0 mm			891532070
Dilatator Ø 9mm WL 200mm  cannulated	red	9.0 mm			891532090
Handle attachment for dilators 					891530000

COXARTIS

Irrigation Cannula



	Ø	Capacity	WL	Product no.
Cannula for irrigation Ø 8mm WL 168mm	8 mm	7 mm	168 mm	891737080





Hip
3.5

COXARTIS

Aiming Device

VI121 || Subject to modifications. Please note that some products may not be available in all countries. For more detailed information, please consult with your contact partner or directly with Richard Wolf GmbH.





		Product no.
Aiming device bndl Comprising:	Hip alignment ARC (891240100), Hip guide sleeve (891240200), Guide attachment AD hip (891240300), Rotatable irrigation ring hip (891240400)	891240000
Hip alignment ARC with adapter for rotatable irrigation ring		891240100
Hip guide sleeve for connection to puncture cannula 891732018		891240200
Guide attachment AD hip for connection to guide sleeve		891240300
Rotatable irrigation ring hip rotatable with 2 stopcocks and adapter for alignment bracket		891240400

Hip
3.6

COXARTIS

Hook Probe / Banana Knife

			
	Height	WL	Product no.
<p>Hook probe WL 150mm H 4.5mm</p> 	4.5 mm	150 mm	891534515

		
	WL	Product no.
<p>Banana knife WL 125mm</p> 	125 mm	8436.251

			
	Width	WL	Product no.
<p>Convex rasp WL 175mm W 4.75mm</p> <p>rough</p> 	4.75 mm	175 mm	89160.3002





Hip
3.7

VII/21 || Subject to modifications. Please note that some products may not be available in all countries. For more detailed information, please consult with your contact partner or directly with Richard Wolf GmbH.

COXARTIS







Curette and Microfractor



		Ø	WL	Product no.
Curette, square, Ø 4.5mm WL 170mm		4.5 mm	170 mm	891632245
Curette, square, Ø 5mm WL 170mm		5.0 mm		891632260
Curette, round, Ø 4.8mm WL 170mm		4.8 mm		891631255
Curette, round, Ø 6.3mm WL 170mm		6.3 mm		891631270

double-blade and curved upward







		Deflection	WL	Product no.
Microfractor WL 170mm 15°		Curved 15°	170 mm	891631521
Microfractor WL 170mm 30°		Curved 30°		891633021
Microfractor WL 170mm 45°		Curved 45°		891634521
Microfractor WL 170 mm 35°		35° S-shaped		891633522
Microfractor WL 170mm 60°		Curved 60°		891636021
Microfractor WL 170mm 60°		60° S-shaped		891636022
Microfractor WL 170mm 80°		Curved 80°		891638021

VI121 || Subject to modifications. Please note that some products may not be available in all countries. For more detailed information, please consult with your contact partner or directly with Richard Wolf GmbH.





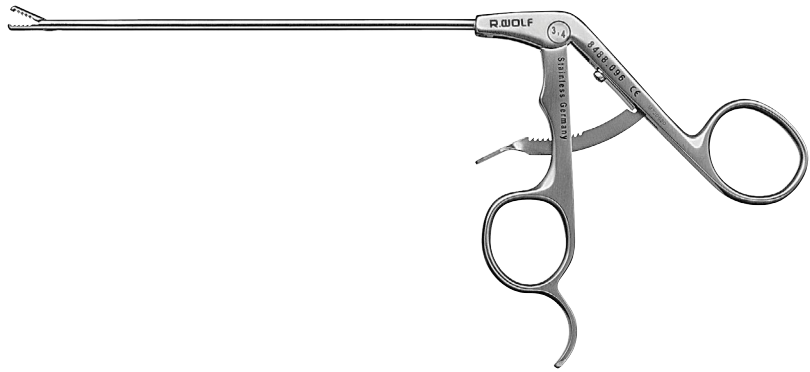



COXARTIS

PULSEShifter Microfractor / Grasping Forceps



		WL	Product no.
<p>PULSEShifter Microfractor WL 170 mm 45°</p> 	<p>curved 45°, can be dismantled</p>	<p>170 mm</p>	<p>891634530</p>

		Ø	WL	Product no.
<p>Grasping forceps Ø 3.4 mm</p>  <p>straight jaw section, serrated, handle with lock</p>	<p>3.4 mm</p>	<p>130 mm</p>	<p>8488.096</p>	



ARTHROline	Jaw section (Height)	WL	Straight	Curved to the left	Curved to the right	Sheath curved upward	Jaws curved upward	Product no.
Punch WL 180mm H 1.6mm  Sectional view: 	1.6 mm	180 mm	●				●	891432102
Punch WL 180mm H 1.6mm  Sectional view: 			●			●	891432101	
Punch WL 180mm H 1.6mm  Sectional view: 			●		●		891432103	
Punch WL 180mm H 1.6mm  Sectional view: 			●	●			891432122	

VI121 || Subject to modifications. Please note that some products may not be available in all countries. For more detailed information, please consult with your contact partner or directly with Richard Wolf GmbH.

Spare part and accessory		Product no.
<p>Sterile adapter eyecup for replacing the endoscope under sterile conditions, locking mechanism</p>		<p>8580.91</p>
<p>Sealing part for sheath</p>		<p>89101.0000</p>
<p>Irrigation ring with 1 stopcock</p>		<p>150081761</p>
<p>Irrigation ring with 2 stopcocks</p>		<p>150081762</p>
<p>Stopcock bndl cap 3.0mm (PACK= 5 PCS)</p>		<p>896.0002</p>
<p>Mounting ring</p>		<p>15008.1704</p>
<p>Spare seal set Comprising: O-ring 9.25X 1.78 VMQ-70 coated (15364396) O-ring 7.65X 1.78 VMQ-70 coated (15364395) (PACK= 5 PCS)</p>		<p>15176.142</p>
<p>Also: O-ring tool</p>		<p>15106.230</p>



Elbow / Foot

Elbow / Foot

4.1

Arthrolution Arthroscopes Overview

4.2

Telescopes and Sheaths

4.3

**Instruments – Drainage Cannulas / Hook Probes / Guide and Marking Rods /
ARTHROline Punches / Scissors / Forceps**

4.4

Instruments for Endoscopically Assisted Decompression of the Ulnar Nerve

arthro
lution Arthroscope

Overview

Elbow / Foot
4.1

arthro <i>lution</i>			Fingers, toes	Hand	Foot, elbow		Knee, shoulder, hip
Telescope Ø			1.9 mm	2.4 mm	2.7 mm		4.0 mm
Telescopes	30°	PANOVIEW telescope	8860453	8871413	8476.433	8672.422	8880.543
		PANOVIEW wide angle telescope					8885.443
	70°	PANOVIEW telescope					8880.545
		PANOVIEW wide angle telescope					8885.445
Sheath WL			40 mm	60 mm	77.5 mm	145 mm	130 mm
Sheaths	with 1 irrigation stopcock, fixed		891220124	891220132			
	with 2 irrigation stopcocks, fixed						89121.0260
	with 1 irrigation stopcock, rotatable					891241141	
	with 2 irrigation stopcocks, rotatable			891221232	891221241	891241241	89121.1260
	High-Flow with 1 irrigation stopcock, fixed		891220128				
	High-Flow with 2 irrigation stopcocks, rotatable			891221235			89121.1263
	Small-caliber with 2 irrigation stopcocks, rotatable						891221255
Obturator	blunt				891222754		89121.0544
	semi-blunt		891221952	891222452			89121.0542
	conical blunt				891222750	891242750	89121.0540
	sharp					891242761	89121.0640
	conical pointed		891221962	891222462	891222762		
Sealing part for sheath						891040000	

VII/21 || Subject to modifications. Please note that some products may not be available in all countries. For more detailed information, please consult with your contact partner or directly with Richard Wolf GmbH.

Telescope 2.7 mm for Standard Arthroscope

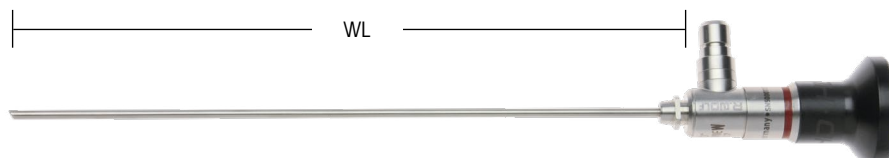

AUTOCLAVE
134° C / 273° F

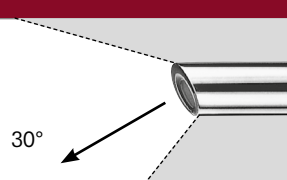
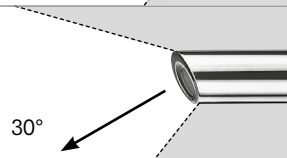
Direction of view		WL	Ø	Product no.
	PANOVIEW PLUS HD telescope 30° Ø 2.7mm WL 103mm	103 mm	2.7 mm	8476.433
	PANOVIEW TELESCOPE 30° Ø 2.7mm WL 182mm	182 mm		8672.422

Recommended accessories		Product no.
Perf. basket for standard telescope 1	(L x B x H) 297 x 59 x 54 mm	38015
Fiber light cable bndl Comprising: Fiber light cable (80663523), adapter, projector to light cable (8095.07), and adapter, light cable to endoscope (809509)	Ø 3.5 mm, 2.3 m long	806635231

Telescope 4.0 mm for Standard Arthroscope

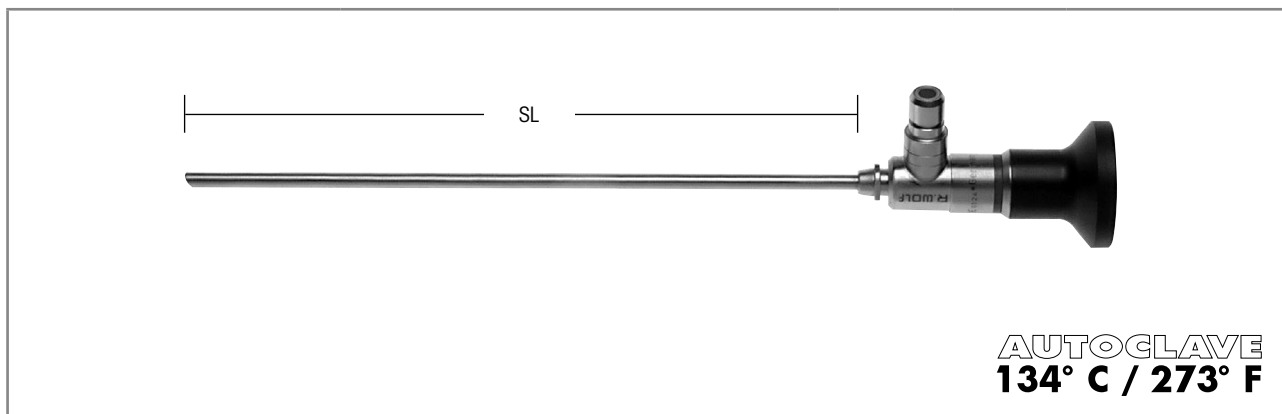

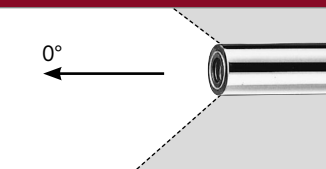
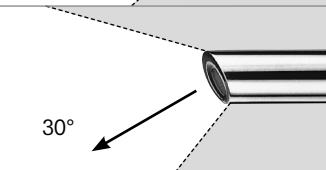
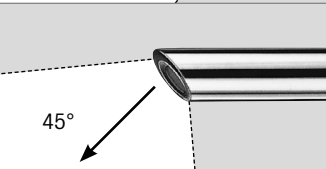
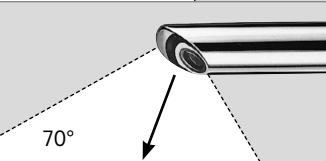
Direction of view		SL	Ø	Product no.
	PANOVIEW telescope 0° Ø 4mm SL 170mm	170 mm	4.0 mm	8880.541
	PANOVIEW telescope 30° Ø 4mm SL 170mm			8880.543
	PANOVIEW telescope 45° Ø 4mm SL 170mm			8880.544
	PANOVIEW telescope 70° Ø 4mm SL 176mm	176 mm		8880.545

Recommended accessories		Product no.
Perf. basket for standard telescope 1	(L x B x H) 297 x 59 x 54 mm	38015
Fiber light cable bndl Comprising: Fiber light cable (80663523), adapter, projector to light cable (8095.07), and adapter, light cable to endoscope (809509)	Ø 3.5 mm, 2.3 m long	806635231

VI121 || Subject to modifications. Please note that some products may not be available in all countries. For more detailed information, please consult with your contact partner or directly with Richard Wolf GmbH.

arthro *lution* Sheath for Arthroscope

with automatic click-lock mechanism

Elbow / Foot



4.2

						
2 rotatable stop-cocks	Outer ø	WL	Product no.			
●	4.1 mm	77.5 mm	891221241	891222754	891222750	891222762

Recommended accessories		Product no.
Sealing part for sheath		89101.0000
Marking rod ø 4.0 mm, TL 325 mm	conical blunt	8863.75
Spare parts		
Irrigation ring with 1 stopcock		150081761
Irrigation ring with 2 stopcocks		150081762
Stopcock bndl cap 3.0mm (PACK= 5 PCS)		896.0002
Also: Disassembly tool		38310.0001
Mounting ring		15008.1704
Spare seal set (O-rings)	Comprising: O-ring, small (PACK= 5 PCS) O-ring, large (PACK= 5 PCS)	15176.142
Also: O-ring tool (disassembly tool)		15106.230

arthro *lution* Sheath for Arthroscope

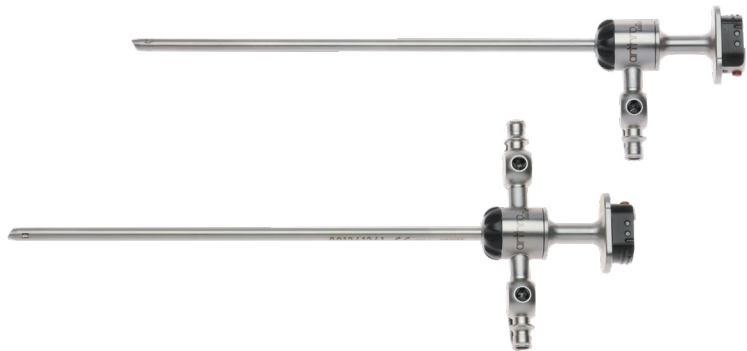
with automatic click-lock mechanism

						
Sheath for arthroscope OD 4.1 mm					Obturator for arthroscope OD 4.1 mm sharp, with slanted tip	Obturator for arthroscope OD 4.1 mm conical blunt
1 rotatable stopcock	2 rotatable stopcocks	Outer Ø	WL	Product no.		
●		4.1 mm	145 mm	891241141	891242761	891242750
	●			891241241		

Elbow / Foot

4.2

Recommended accessories		Product no.
Sealing part for sheath		891040000
Marking rod Ø 2.7 mm, TL 250 mm	conical pointed	891242725
Spare parts		
Irrigation ring with 1 stopcock		150081761
Irrigation ring with 2 stopcocks		150081762
Stopcock bndl cap 3.0mm (PACK= 5 PCS)		896.0002
Also: Disassembly tool		38310.0001
Mounting ring		15008.1704
Spare seal set (O-rings)	Comprising: O-ring, small (PACK= 5 PCS) O-ring, large (PACK= 5 PCS)	15176.142
Also: O-ring tool (disassembly tool)		15106.230





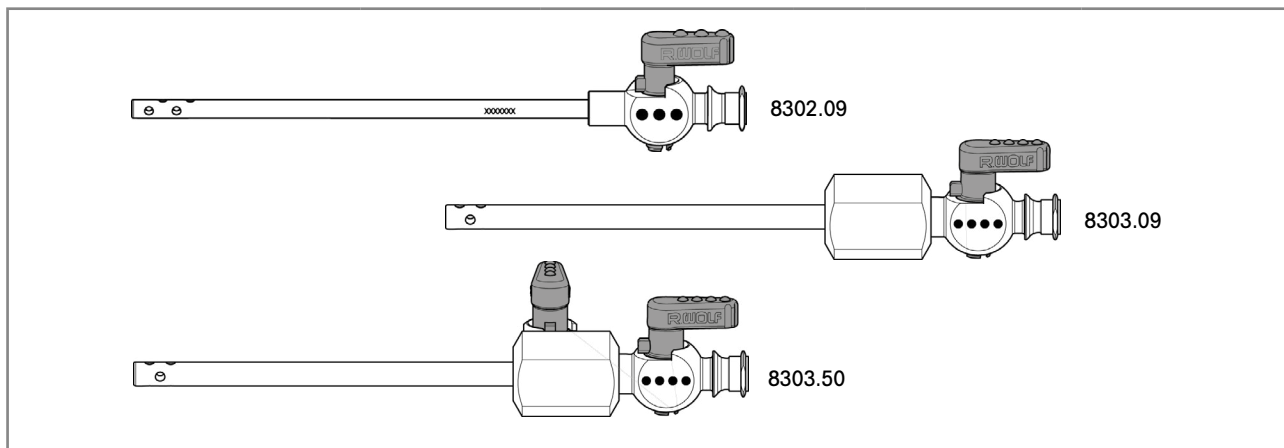

VI121 || Subject to modifications. Please note that some products may not be available in all countries. For more detailed information, please consult with your contact partner or directly with Richard Wolf GmbH.

Drainage Cannula Ø 2.3 mm / 3.7 mm

Elbow / Foot

4.3





Drainage for cannula and obturator		Capacity	Ø	WL	Product no.
Drainage for cannula Ø 3.2mm WL 80mm with 1 insufflation stopcock		2.3 mm	3.2 mm	80 mm	8302.09
Drainage for cannula Ø 4.5mm WL 71.5mm with 1 insufflation stopcock		3.7 mm	4.5 mm	71.5 mm	8303.09
Drainage for cannula Ø 4.5mm WL 71.5mm with 2 insufflation stopcocks		3.7 mm	4.5 mm	71.5 mm	8303.50
Obturator for cannula OD 3.2mm sharp, with slanted tip		-	2.3 mm	103 mm	8302.101
Obturator for cannula OD 3.2mm conical blunt tip		-	2.3 mm	103 mm	8302.11
Obturator for cannula OD 4.5mm sharp, with pyramid-shaped tip		-	4.5 mm	115 mm	8303.10
Obturator for cannula OD 4.4mm conical blunt tip		-	4.4 mm	115 mm	8303.11
Also:					
Silicone tube with Luer fitting 886.00	for Drainage for cannula 8302.09		Length 2.0 m		8302.90
Silicone tube with Luer fitting 886.01	for Drainage for cannula 8303.09 / 50				8303.90

VII.21 || Subject to modifications. Please note that some products may not be available in all countries. For more detailed information, please consult with your contact partner or directly with Richard Wolf GmbH.

Hook Probe / Marking Rod



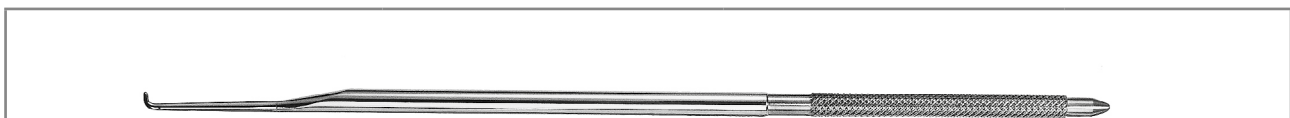

	H	WL	Product no.
Hook probe WL 115mm H 7mm, graduated 	7.0 mm	115 mm	8399.901
Hook probe WL 115mm H 4.5mm, graduated 	4.5 mm		8399.95



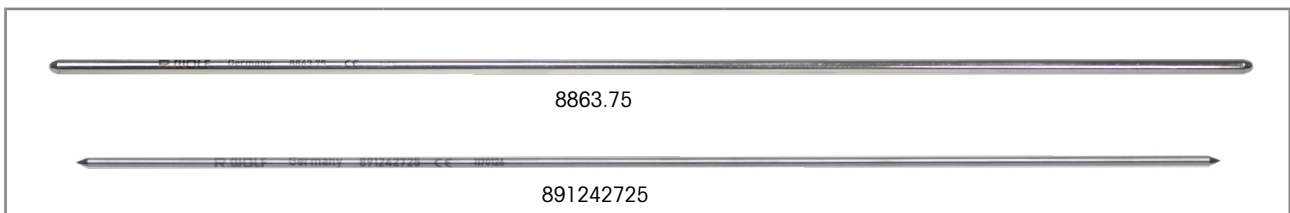





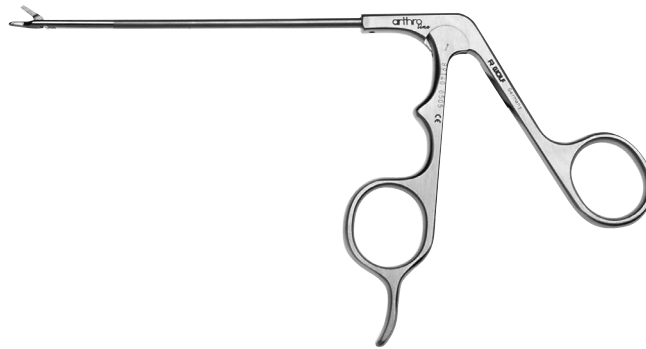



	Ø	TL	Product no.
Hook probe TL 228 mm SZ 4.4mm 	4.4 mm	228 mm	8863.80











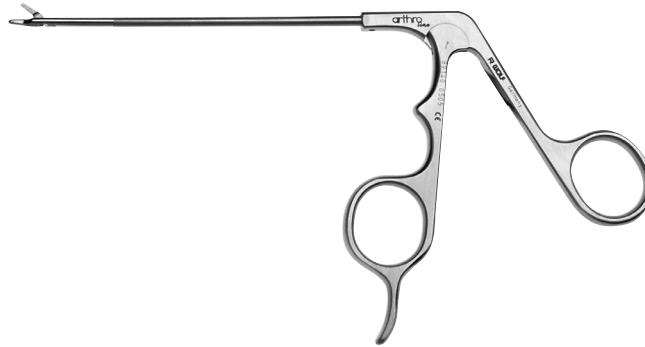



	Ø	TL	Product no.
Marking rod Ø 4.0mm conical blunt 	4.0 mm	325 mm	8863.75
Marking rod Ø 2.7mm conical pointed 	2.7 mm	250 mm	891242725



ARTHROline	Jaw section (Height x width)	Cut width	WL	Straight	Curved to the left	Sheath curved upward	Jaw section curved upward	Product no.		
Punch W 4.6 mm H 1.6 mm movable jaw section serrated  Sectional view: 	1.6 x 4.6 mm	3.3 mm	120 mm	●				89140.0105		
Punch W 4.6 mm H 1.6 mm movable jaw section serrated  Sectional view: 							●	89140.0102		
Punch W 4.6 mm H 1.6 mm movable jaw section serrated  Sectional view: 								●	89140.0122	
Punch W 5.5 mm H 1.6 mm movable jaw section serrated  Sectional view: 								●	●	89140.0101
Punch W 5.5 mm H 1.6 mm movable jaw section serrated  Sectional view: 									●	89140.0103







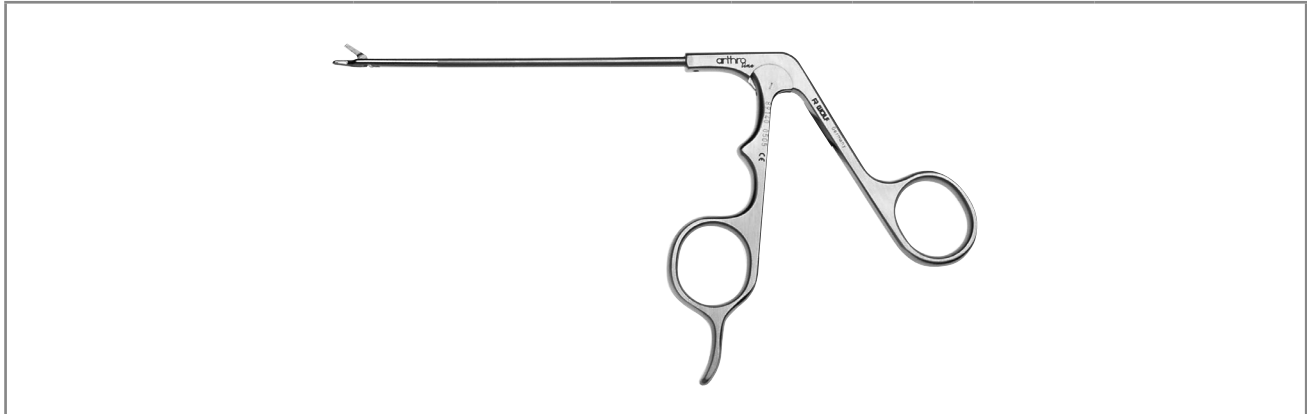

arthro
line Hook Punch / Basket Punch



ARTHROline	Jaw section (Height x width)	Cut width	WL	Straight	Jaw section curved upward	Product no.
Hook punch W 3mm H 1.6mm  Sectional view: 	1.6 x 3.0 mm	1.8 mm	120 mm	●		89140.0205
Hook punch W 3mm H 1.6mm  Sectional view: 				●	89140.0202	
Basket punch W 6.5mm H 2.1mm oval  Sectional view: 	2.1 x 6.5 mm	4.5 mm		●		89140.0305
Basket punch W 6.5mm H 2.1mm oval  Sectional view: 				●	89140.0302	
Hook punch W 4mm H 2.1mm  Sectional view: 	2.1 x 4.0 mm	2.1 mm		●		89140.0405
Hook punch W 4 mm H 2.1mm  Sectional view: 				●	89140.0402	



arthro
line Punch / Scissors Punch





ARTHROline	Jaw section (Height x width)	Cut width	WL	Straight	Retrograde cutting	Jaw section curved upward	Product no.
Scissors punch W 2.4mm H 2.1 mm  Sectional view: 	2.1 x 2.4 mm	0.9 mm	120 mm	●			89140.0505
Scissors punch W 2.4mm H 2.1 mm  Sectional view: 					●		89140.0502
Punch W 5.7mm H 4mm retrograde left-cutting  Sectional view: 	4.0 x 5.7 mm	2.3 mm		●	left		89140.0605
Punch W 5.7mm H 4mm retrograde right-cutting  Sectional view: 				●	right		89140.0602



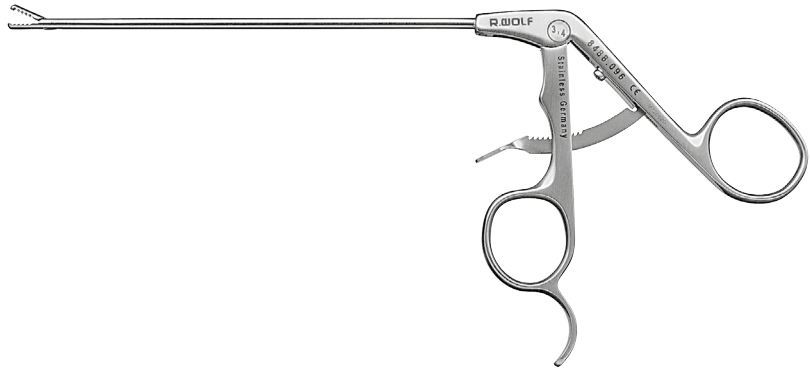

VI121 || Subject to modifications. Please note that some products may not be available in all countries. For more detailed information, please consult with your contact partner or directly with Richard Wolf GmbH.

Suction Punch with Integrated Suction Channel

			
	Ø	WL	Product no.
<p>Suction punch Ø 2.7 mm with integrated suction channel</p> 	2.7 mm	110 mm	89140.0027





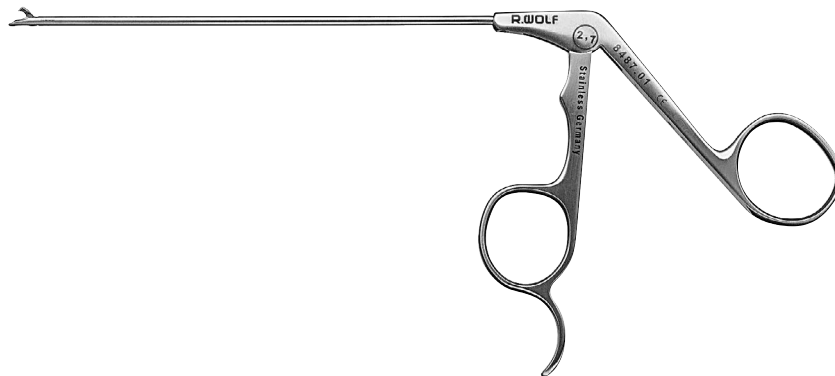

Grasping Forceps / Miniature Forceps

			
	Ø	WL	Product no.
Grasping forceps Ø 3.4mm straight jaw section, serrated, handle with lock 	3.4 mm	130 mm	8488.096

			
With overload protection and irrigation connector	Sheath Ø	WL	Product no.
Miniature forceps Ø 2.7mm  with double spoon jaw	2.7 mm	110 mm	8486.614
Miniature grasping forceps Ø 2.7mm 			8486.624
Hook punch Ø 2.7mm 			8486.604

Hook Punch / Punch







	Sheath Ø	WL	Jaw section (Height x width)	Cut width	Straight	Curved to the left	Curved to the right	Sheath curved 15° upward	Jaw section curved 15° upward	Product no.			
Hook punch Ø 3,4mm with shovel	3,4 mm	130 mm	3,4 x 3,4 mm	1,6 mm	●					8488.951			
						●						8488.952	
							●						8488.953
Sectional view: 											●		
Hook punch Ø 3.4mm movable jaw section serrated	3,4 mm	130 mm	3,4 x 3,4 mm	1,6 mm	●					8488.02			
											●		8488.025
Hook punch Ø 3.4mm serrated	3,4 mm	130 mm	1,93 x 3,9 mm	2,7 mm	●					8488.121			
												●	
Hook punch Ø 4.5mm with shovel, serrated	4,5 mm		1,73 x 5,4 mm	3,4 mm					●	8489.063			
													
Sectional view: 													

Punch / Double Spoon Forceps

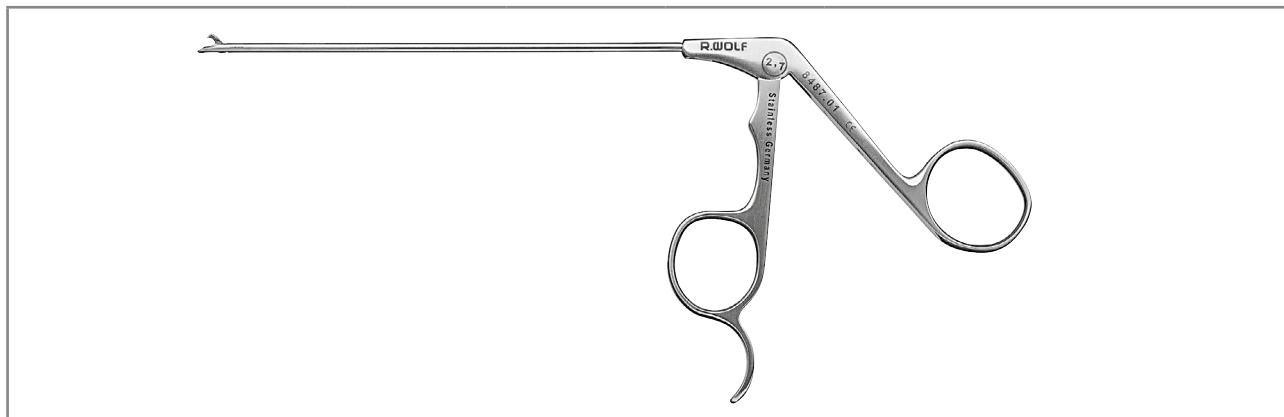
Elbow / Foot

4.3



	Jaw section (Height x width)	Deflection	Cut width	WL	Product no.
Punch Ø 3.4mm front- and side-cutting  Sectional view: 	2.2 x 5.3 mm	90° left	3.4 mm	130 mm	8404.017
		90° right			8404.018
Hook punch with shovel Ø 3.4mm  Sectional view: 	2.1 x 2.0 mm	45° left	1.7 mm		8404.71*
		45° right			8404.81*

* particularly suitable for lateral cutting and smoothing

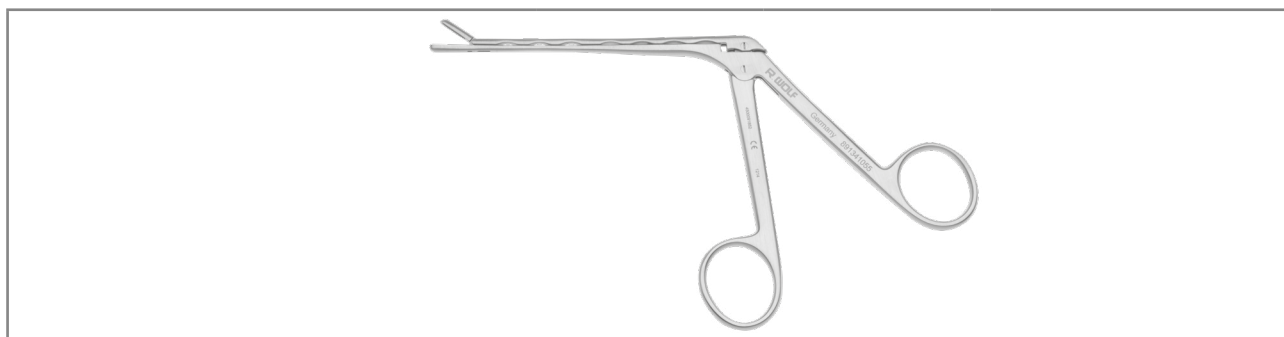



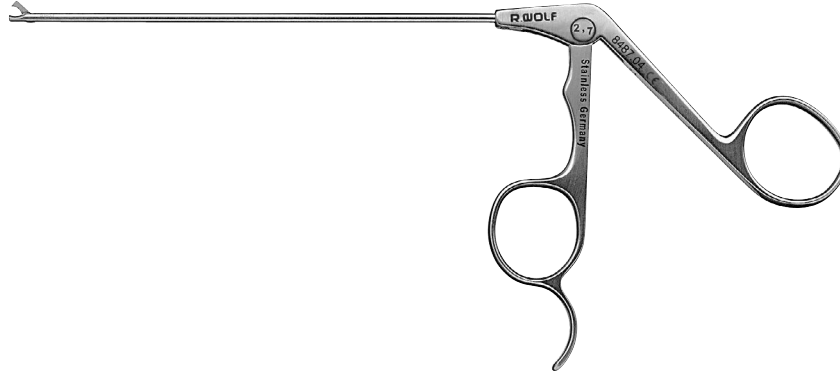

	Jaw section (Height x width)	WL	Product no.
Double spoon forceps W 3.1mm H 4.6mm wave-shaped sheath 	4.6 x 3.1 mm	105 mm	891341055

VII.21 || Subject to modifications. Please note that some products may not be available in all countries. For more detailed information, please consult with your contact partner or directly with Richard Wolf GmbH.

Hook Scissors





	WL	Straight jaw section	Straight sheath	Sheath curved to the left	Sheath curved to the right	Product no.	
Hook scissors Ø 2.7mm 	130 mm	●	●			8487.04	
Hook scissors Ø 3.4mm 		●	●			8488.04	
Micro scissors Ø 3.4mm  Sectional view: 		●		●		8488.041	
		●			●		8488.042
		●		●			8488.052
			●			●	8488.053
	WL	Jaw section deflection	Straight sheath		Product no.		
Hook scissors Ø 3.4mm 	130 mm	45° left		●	8404.52		
		45° right		●	8404.62		

VI121 || Subject to modifications. Please note that some products may not be available in all countries. For more detailed information, please consult with your contact partner or directly with Richard Wolf GmbH.

Hand Instruments
Curette / Microfractor



		Deflection	WL	Product no.
Microfractor WL 65mm 30°		Curved 30°	65 mm	891643011
Microfractor WL 65mm 45°		Curved 45°		891644511
Microfractor WL 65mm 60°		Curved 60°		891646011

Instruments for Endoscopically Assisted Decompression of the Ulnar Nerve

Optical dissector / telescope



	WL	Product no.
Opt. dissector WL 158mm graduated	158 mm	891607001

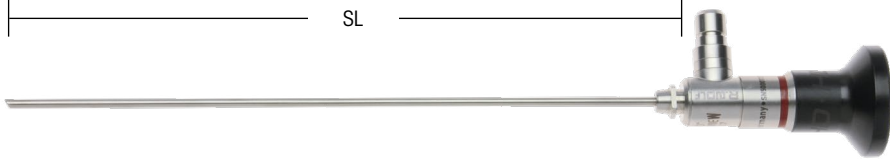

AUTOCLAVE
134° C / 273° F

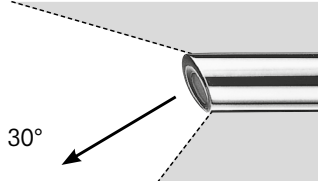
Direction of view		SL	Ø	Product no.
	PANOVIEW telescope 30° Ø 4mm SL 170mm	170 mm	4.0 mm	8880.543

Recommended accessories		Product no.
Perf. basket for standard telescope 1	(L x B x H) 297 x 59 x 54 mm	38015
Fiber light cable bndl Comprising: Fiber light cable (80663523), adapter, projector to light cable (8095.07), and adapter, light cable to endoscope (809509)	Ø 3.5 mm, 2.3 m long	806635231

Instruments for Endoscopically Assisted Decompression of the Ulnar Nerve

Speculum



	WL	Product no.
Speculum w. Removable light rod WL 55 mm comprising: Speculum WL 55mm (8916070021) and light rod (8916070022)	55 mm	891607002



Hand / Fingers / Toes

Hand / Fingers / Toes

5.1

Arthrolution Arthroscopes Overview

5.2

Telescopes and Sheaths

5.3

Punches / Forceps / Instruments for Small Joints

5.4

ENDO-CARTRIS – Instruments for Carpal Tunnel Release

arthro*lution* Arthroscope

Overview

arthro <i>lution</i>			Fingers, toes	Hand	Foot, elbow		Knee, shoulder, hip
Telescope Ø			1.9 mm	2.4 mm	2.7 mm		4.0 mm
Telescopes	30°	PANOVIEW telescope	8860453	8871413	8476.433	8672.422	8880.543
		PANOVIEW wide angle telescope					8885.443
	70°	PANOVIEW telescope					8880.545
		PANOVIEW wide angle telescope					8885.445
Sheath WL			40 mm	60 mm	77.5 mm	145 mm	130 mm
Sheaths	with 1 irrigation stopcock, fixed		891220124	891220132			
	with 2 irrigation stopcocks, fixed						89121.0260
	with 1 irrigation stopcock, rotatable					891241141	
	with 2 irrigation stopcocks, rotatable			891221232	891221241	891241241	89121.1260
	High-Flow with 1 irrigation stopcock, fixed		891220128				
	High-Flow with 2 irrigation stopcocks, rotatable			891221235			89121.1263
	Small-caliber with 2 irrigation stopcocks, rotatable						891221255
Obturator	blunt				891222754		89121.0544
	semi-blunt		891221952	891222452			89121.0542
	conical blunt				891222750	891242750	89121.0540
	sharp					891242761	89121.0640
	conical pointed		891221962	891222462	891222762		
Sealing part for sheath						891040000	

Hand
5.1

VII/21 || Subject to modifications. Please note that some products may not be available in all countries. For more detailed information, please consult with your contact partner or directly with Richard Wolf GmbH.

Telescope 1.9 mm / 2.4 mm for Standard Arthroscope

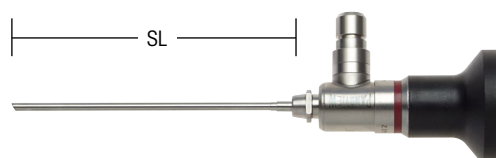

AUTOCLAVE
134° C / 273° F

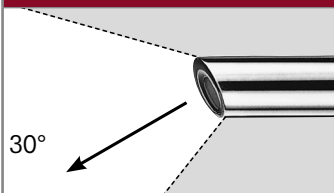
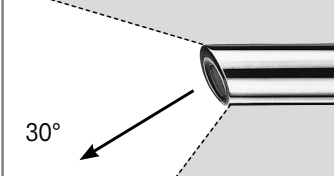
Direction of view		SL	∅	Product no.
	PANOVIEW telescope 30° ∅ 1.9mm SL 61mm	61 mm	1.9 mm	8860453
	PANOVIEW telescope ∅ 2.4mm SL 98mm	98 mm	2.4 mm	8871413

Recommended accessories		Product no.
Perf. basket for standard telescope 1	(L x B x H) 297 x 59 x 54 mm	38015
Fiber light cable bndl Comprising: Fiber light cable (80663523), adapter, projector to light cable (8095.07), and adapter, light cable to endoscope (809509)	∅ 3.5 mm, 2.3 m long	806635231

arthro *lution* Sheath for Arthroscope

with automatic click-lock mechanism

						
Sheath for arthroscope OD 2.4 mm (telescope Ø 8860453)					Obturator for arthroscope OD 2.4/2.8 mm semi-blunt	Obturator for arthroscope OD 2.4/2.8 mm conical pointed
High-Flow	1 fixed stopcock	Outer Ø	WL	Product no.		
	●	2.4 mm	40 mm	891220124	891221952	891221962
●	●	2.8 mm		891220128		



Hand
5.2

Spare parts		Product no.
Irrigation ring with 1 stopcock		150081761
Stopcock bndl cap 3.0mm (PACK= 5 PCS)		896.0002
Also: Disassembly tool		38310.0001
Mounting ring		15008.1704
Spare seal set (O-rings)	Comprising: O-ring, small (PACK= 5 PCS) O-ring, large (PACK= 5 PCS)	15176.142
Also: Disassembly tool		15106.230

VI121 || Subject to modifications. Please note that some products may not be available in all countries. For more detailed information, please consult with your contact partner or directly with Richard Wolf GmbH.

arthro *lution* Sheath for Arthroscope

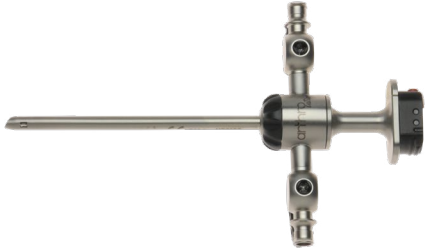
with automatic click-lock mechanism





							
Sheath for arthroscope OD 3.2 / 3.5 mm (telescope Ø 8871413)						Obturator for arthroscope OD 3.2/3.5 mm semi-blunt	Obturator for arthroscope OD 3.2/3.5 mm conical pointed
High-Flow	1 fixed stopcock	2 rotatable stopcocks	Outer Ø	WL	Product no.		
	●		3.2 mm	60 mm	891220132	891222452	891222462
		●			891221232		
●		●	3.5 mm		891221235		

Spare parts		Product no.
Irrigation ring with 1 stopcock		150081761
Irrigation ring with 2 stopcocks		150081762
Stopcock bndl cap 3.0mm (PACK= 5 PCS)		896.0002
Also: Disassembly tool		38310.0001
Mounting ring		15008.1704
Spare seal set (O-rings)		15176.142
Also: Disassembly tool		15106.230

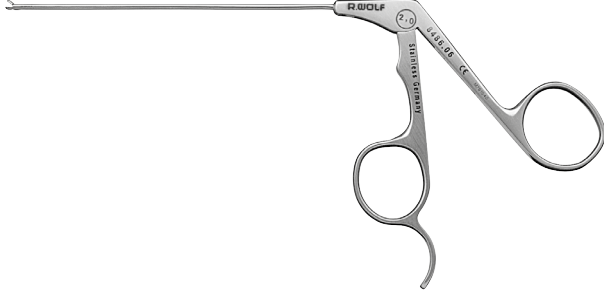

VI121 || Subject to modifications. Please note that some products may not be available in all countries. For more detailed information, please consult with your contact partner or directly with Richard Wolf GmbH.

Miniature Punch / Forceps



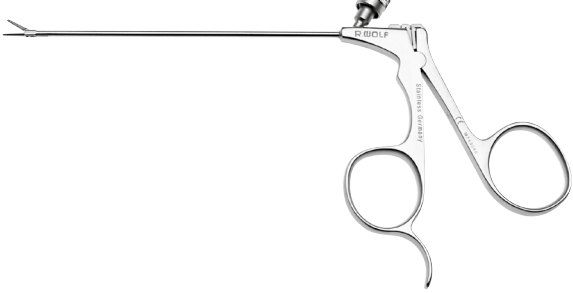



		Ø	WL	Product no.
Hook punch Ø 2 mm		2.0 mm	65 mm	8486.601
Miniature punch Ø 2.2 mm		2.2 mm	75 mm	8486.602
Miniature forceps Ø 2 mm with double spoon jaw		2.0 mm	60 mm	8486.611
Miniature grasping forceps Ø 2 mm		2.0 mm	60 mm	8486.621



		Sheath Ø	WL	Product no.
Miniature forceps Ø 2.7mm with double spoon jaw		2.7 mm	110 mm	8486.614
Miniature grasping forceps Ø 2.7mm				8486.624
Hook punch Ø 2.7mm				8486.604

Instruments for Small Joints

			
	∅	WL	Product no.
Spoon ∅ 2.4x1mm WL 100mm 	2.4 x 1 mm	100 mm	8871.562
Curette round ∅ 1.45mm WL 100mm 	1.45 mm		8871.571
Knife with handle WL 100mm 	--		8871.586
Hook probe WL 100mm H2mm H = 2.0 mm 	--		8871.721



FLUID CONTROL

Irrigation and Suction Pumps

FLUID CONTROL Irrigation and Suction Pump

6.1

FLUID CONTROL Arthro 2204

FLUID CONTROL Arthro 2204

Suction and irrigation pump for arthroscopy
with automatic tube recognition



FLUID CONTROL Arthro

is a new pump system for arthroscopy and fully endoscopic spinal surgery. The particular strength of this system lies in a practical combination of high performance and a cost-effective overall concept. The new software and technical enhancements make the **FLUID CONTROL Arthro** ideal for diagnostic and therapeutic arthroscopies.

FLUID CONTROL Arthro has already been prepared for integration in core, the digital OR from Richard Wolf.

FLUID CONTROL Arthro 2204

Suction and irrigation pump for arthroscopy
with automatic tube recognition



Arthro/spine suc./irrig.pump bndl

for arthroscopy **22040011**

Comprising:

- 1 x arthro/spine suc./irrig.pump 200mmHG 2204001
- 1 x irrigation tube set spike 8171223
- 1 x tube set for vacuum, incl. filter 2206207
- 1 x protection filter for gas filtration 4171.121
- 1 x power cable 2440.03

Arthro/spine suc./irrig.pump bndl

with Spine Mode software module for arthroscopy and
fully endoscopic spinal surgery **22040012**

Comprising:

- 1 x arthro/spine suc./irrig.pump 200mmHG 2204001
- 1 x Spine mode software module2204101
- 1 x irrigation tube set spike 8171223
- 1 x tube set for vacuum, incl. filter 2206207
- 1 x protection filter for gas filtration 4171.121
- 1 x power cable 2440.03

Recommended accessories		Product no.
Footswitch		2204901

FLUID CONTROL Arthro 2204

Irrigation and suction pump for arthroscopy with automatic tube recognition

Day-patient tube set

From two interventions/patients per day:

Use the **day-patient tube set**, which comprises a day tube and a connected patient tube. The day tube remains in the pump throughout the day, while the patient tube has to be changed for each operation. The irrigation fluid bag can remain on the pump until it has been comple-

tely used up. **This significantly reduces the amount of waste and cuts costs.**

Further tube versions are available to complement the system.

Note: The use of the day-patient tube set has not been approved for the Spine Mode application.

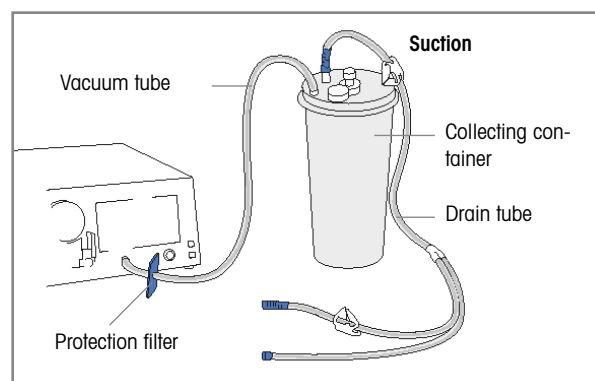
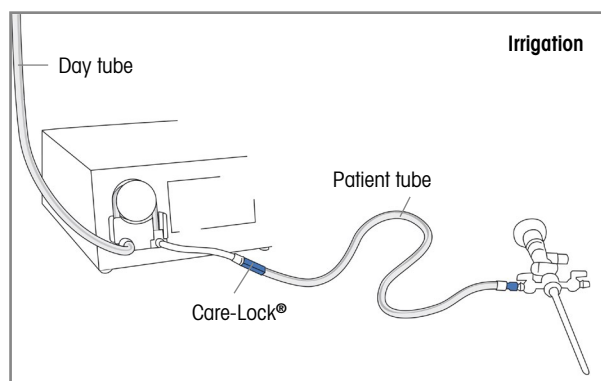

Irrigation			Product no.
Accessories – reusable	Irrigation tube set spike	With Luer-Lock connection, autoclavable, incl. 10 spare membranes, reusable for 20 reprocessing cycles	8171223
	Irrigation tube set with spike L 3 m	(PACK= 10 PCS), with Luer-Lock connection, sterile, disposable product	4171223
Accessories – disposable	Irrigation tube set CARE-LOCK, L 3 m	(PACK= 10 PCS), sterile, disposable product	4171224
	Day irrigation tube set	(PACK= 10 PCS), with piercing spike, sterile disposable product, PVC	4171226
	Patient irrigation tube set L 3m	(PACK= 10 PCS), with Luer-Lock connection, sterile, disposable product, PVC	4171227
<i>Note: Day tube and patient tube can only be used together. A new patient tube is required for each patient – the day tube can be used for up to 20 patients.</i>			

Suction			Product no.
Accessories – reusable	Tube set for vacuum, incl. filter	with integrated hygiene filter, PACK= 10 PCS, service life of 30 days (connected to irrigation pump)	2206207
Accessories – disposable	Secretion container, 2 L	2 liters, no lid	8170.6551
	Secretion container, 2.5 L	2.5 liters (PACK= 2 PCS)	41706566
	Tube set for suction (with 2 ports)	sterile, disposable, (PACK= 10 PCS) for connecting instruments to collecting container	T0503-01

VII/21 || Subject to modifications. Please note that some products may not be available in all countries. For more detailed information, please consult with your contact partner or directly with Richard Wolf GmbH.

Technical Data

FLUID CONTROL Arthro 2204

Arthro/spine suc./irrig.pump 200mmHG	2204001
Power supply connection	100–240 VAC, 50/60 Hz
Power consumption	118 VA
Protection class to VDE 0750 / IEC 601	1
Classification	CF
Pressure range (infinite preselection)	15–200 mmHg
Delivery rate (can be preselected in 50 ml increments)	0–2 l/min
Dimensions (W x H x D)	300 x 157 x 436 mm
Weight	8.3 kg
Interfaces	USB / CAN bus (core) service interface



Universal Motor Systems

Universal Motor Systems

7.1

PowerSpeed AS1 Universal Motor System

7.2

Power Stick M5/3 and M5/0 Motor Handpieces for PowerSpeed AS1

7.3

Reusable Shaver Blades and Burrs

for Power Stick M5/3, Power Stick M5/0, and Micro Stick S1

7.4

Disposable Shaver Blades and Burrs

for Power Stick M5/3, Power Stick M5/0, and Micro Stick S1

PowerSpeed AS1

Universal motor system



The PowerSpeed AS1 motor system has been developed for universal use and provides extremely comfortable and ergonomic handling.

Quick and powerful resecting, drilling, burring, or sawing – anything is possible.

- Wide range of disposable and reusable shaver blades and burrs
- Intelligent tool detection via RFID chip
- Touchscreen makes user interface easy to operate
- Communication interface with FLUID CONTROL ArthroPump 2204 and **core nova**
- Universal use of all current Richard Wolf motor handpieces
- Wireless footswitch
- Universal use in spinal surgery, bronchoscopy, and arthroscopy

PowerSpeed AS1

Universal motor system

Motor Systems
7.1



MOTOR CONTROL UNIT 2305

Power supply connection 50/60 Hz, 100–240 V

includes power supply cable,

CAN bus connection cable, and packaging **2305001**

Universal motor system for orthopedics and spinal surgery, for connecting motor handpieces when working with shaver and high-speed applications, and for connecting the Power Drill M1.

Recommended accessories		Product no.
Remote footswitch 2 pedals+2 buttons		2305100
Also:		
Power supply unit 6600403		FW8002M/08
Backup cable, WL 3m		2305300

VII.21 || Subject to modifications. Please note that some products may not be available in all countries. For more detailed information, please consult with your contact partner or directly with Richard Wolf GmbH.

Technical Data

PowerSpeed AS1

MOTOR CONTROL UNIT 2305	2305001
Power supply connection	100–240 VAC, 50/60 Hz
Power consumption	250 VA
Electromagnetic compatibility EMC to	IEC / EN 60601-1-2
Medical Devices Directive 93/42/EEC	Class IIa
Protection class to IEC / EN 60601-1 (ANSI / AAMI ES60601-1 / CAN CSA-C22.2 No. 60601-1)	I
Protection against electric shock	Type BF applied part
Degree of protection against the ingress of liquids	IP 20 (not protected)
Operating mode	Continuous operation
Degree of protection in the presence of flammable mixtures	Device is not protected against explosions (do not operate device in areas where there is a danger of explosion)
Weight	9.2 kg
Dimensions (W x H x D)	300 x 159.5 x 404 mm

Power Stick M5/3

Power Stick M5/0

Motor Handpieces for PowerSpeed AS1

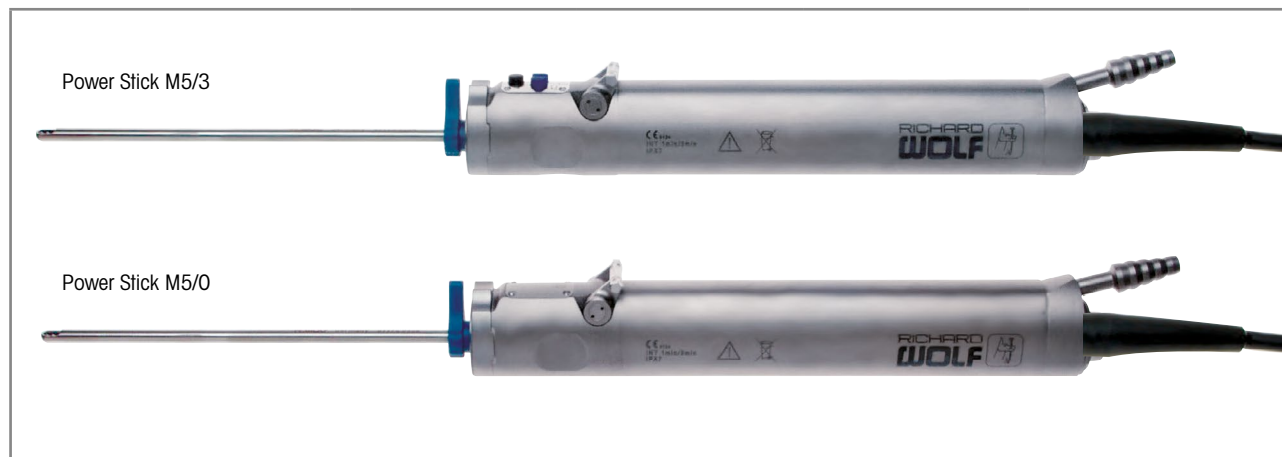

For driving rotation tools with three function buttons			Ø for shaver tools	Product no.
Power Stick M5/3 Motor handpiece max. 16000 rpm	with fixed connection cable, 3.0 m	Operated via button cluster and footswitch	2–6.5 mm	8995500031
	with removable connection cable, 3.0 m			89955.0003
For driving rotation tools			Ø for shaver tools	Product no.
Power Stick M5/0 Motor handpiece max. 16000 rpm	with fixed connection cable, 3.0 m	Operated via footswitch	2–6.5 mm	8995500001
	with removable connection cable, 3.0 m			89955.0000

- Handpieces with/without control panel
- Up to 16,000 rpm
- For tools with a diameter of 2.5–6.5 mm
- Oscillation frequency of up to 4 Hz

Recommended accessories		Product no.
Connection cable, WL 3m	3.0 m long	8564.851
Container (wxhxd) 400x60x200mm	Holds: Instruments, for sterilization (steam and low-temperature), storage and transport, with instrument mat, inner dimensions (wxhxd): 400x57x200mm, outer dimensions (BxHxT): 466x77x266mm	33022

Micro Stick S1

Motor handpiece for PowerSpeed AS1

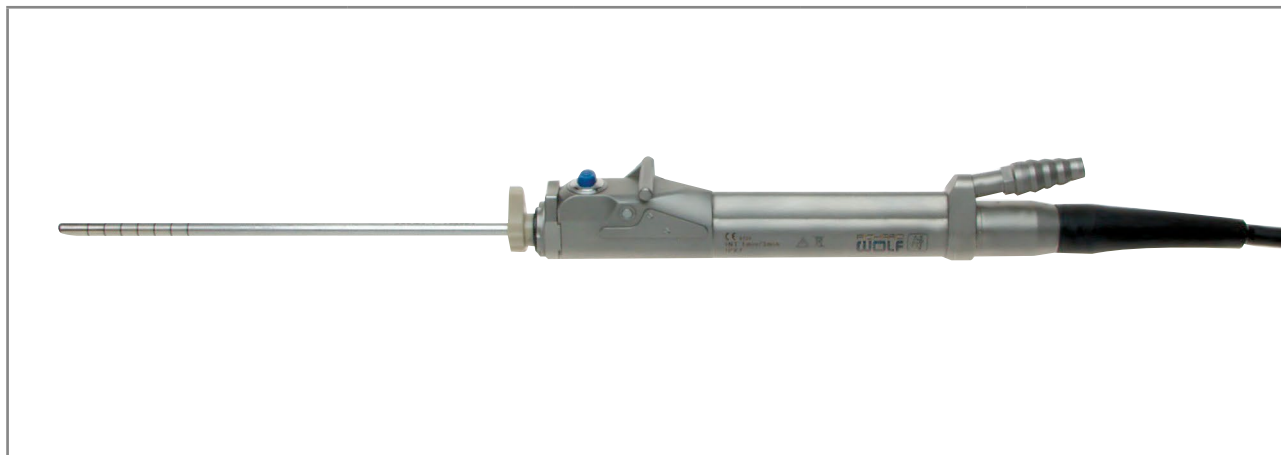

For driving rotation tools with one function button			Ø for shaver tools	Product no.
Motor handpiece max. 3000 rpm	with fixed connection cable, 3.0 m	Operated via the ON/OFF button	2–3.5 mm	899510001





- Mini motor handpiece for exceptional precision in small joints
- Up to 3,000 rpm
- Practical range of accessories
- For shaver tools with a diameter of 2–3.5 mm

Recommended accessories		Product no.
Container (wxhxd) 400x60x200mm	Holds: Instruments, for sterilization (steam and low-temperature), storage and transport, with instrument mat, inner dimensions (wxhxd): 400x57x200mm, outer dimensions (BxHxT): 466x77x266mm	33022

Reusable Shaver Blades and Burrs

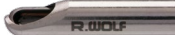
for Power Stick M5/3 and M5/0 motor handpiece,
large interface









	Reusable (1 PC)	Color coding	WL	∅	Product no.
	Resector smooth ∅ 3.5mm	canary yellow	130 mm	3.5 mm	899750003
	Resector smooth ∅ 4.5mm			4.5 mm	899750004
	Resector smooth ∅ 5.5mm			5.5 mm	899750005
	Resector toothed ∅ 2mm	ocher	45 mm	2.0 mm	89975.0032
	Resector toothed ∅ 2.7mm		80 mm	2.7 mm	899750132
	Resector toothed ∅ 3.5mm		130 mm	3.5 mm	89975.0033
	Resector toothed ∅ 4.5mm			4.5 mm	89975.0034
	Resector toothed ∅ 5.5mm			5.5 mm	89975.0035
	Resector aggress ∅ 2.7mm	red	80 mm	2.7 mm	899750332
	Resector aggress ∅ 3.7mm		130 mm	3.7 mm	89975.0333
	Resector aggress ∅ 4.7mm			4.7 mm	89975.0334
	Resector aggress ∅ 5.85mm			5.85 mm	899750335
	Resector oval ∅ 3.5mm	white	130 mm	3.5 mm	89975.0113
	Resector oval ∅ 4.5mm			4.5 mm	89975.0114
	Resector oval ∅ 5.5mm			5.5 mm	89775.0115

Reusable Shaver Blades and Burrs

for Power Stick M5/3 and M5/0 motor handpiece,
large interface



	Reusable (1 PC)	Color coding	WL	Ø	Product no.
	Resector convex curved smooth Ø 3.5mm	canary yellow	130 mm	3.5 mm	89975.0253
	Resector convex curved smooth Ø 4.5mm			4.5 mm	89975.0254
	Resector concave curved smooth Ø 3.5mm	canary yellow	130 mm	3.5 mm	89975.0263
	Resector concave curved smooth Ø 4.5mm			4.5 mm	89975.0264
	End cutter Ø 3.5mm	black	130 mm	3.5 mm	89975.0493
	End cutter Ø 4.5mm			4.5 mm	89975.0494
 with lateral protection	Burr round Ø 3mm	gulf blue	80 mm	3.0 mm	89975.0503
	Burr round Ø 4.5mm		130 mm	4.5 mm	89975.0504
	Burr round Ø 5.5mm			5.5 mm	89975.0505
 no hood	Burr round Ø 6mm	royal blue	130 mm	6.0 mm	89975.0516
 with lateral protection	Acromionizer Ø 3.5mm	purple	130 mm	3.5 mm	89975.0553
	Acromionizer Ø 4.5mm			4.5 mm	89975.0554
	Acromionizer Ø 5.5mm			5.5 mm	89975.0555
	Acromionizer Ø 6.5mm			6.5 mm	89975.0556

Reusable Shaver Blades and Burrs

for Power Stick M5/3 and M5/0 motor handpiece
for hip arthroscopy



	Reusable (1 PC)	Color coding	WL	Ø	Product no.
	Resector toothed Ø 4.7mm	ocher	200 mm	4.7 mm	899732004*
	Resector aggress Ø 4.7mm	red	200 mm	4.7 mm	899732334*
	Resector convex curved aggress Ø 4.7mm	red	200 mm	4.7 mm	899732254
	Resector convex curved aggress Ø 4.7mm	red	200 mm	4.7 mm	899732264
 with 2 mm retracted lateral protection	Burr round Ø 5.5mm	gulf blue	200 mm	5.5 mm	899732504
 with 2 mm retracted lateral protection	Acromionizer Ø 5.5mm	purple	200 mm	5.5 mm	899732555

* Shaver blade with distal guide hole for guide wire Ø 2.0 mm

Reusable Shaver Blades and Burrs

for Micro Stick S1,
small interface



	Reusable (1 pc)	Color coding	WL	Ø	Product no.
	Resector toothed Ø 2mm	ocher	45 mm	2.0 mm	89971.0032
	Resector toothed Ø 3.5mm		130 mm	3.5 mm	89971.0033
	Resector toothed Ø 4.5mm			4.5 mm	89971.0034
	Resector toothed Ø 2.5mm		80 mm	2.5 mm	899710132
	Resector aggress Ø 2.7mm	red	80 mm	2.7 mm	899710332
	Resector oval Ø 3.5mm	white	130 mm	3.5 mm	89971.0113
	Resector oval Ø 4.5mm			4.5 mm	89971.0114
	Resector convex curved smooth Ø 4.5mm	canary yellow	130 mm	4.5 mm	89971.0254
	Resector concave curved smooth Ø 4.5mm	canary yellow	130 mm	4.5 mm	89971.0264
 with lateral protection	Burr round Ø 3mm	gulf blue	80	3.0 mm	89971.0503

Disposable Shaver Blades and Burrs

for Power Stick M5/3 and M5/0 motor handpiece



	Disposable (5 PCS, in individual sterile packaging)	Color coding	WL	∅	Product no.
	Resector smooth ∅ 3.5mm	canary yellow	130 mm	3.5 mm	49975.0003
	Resector smooth ∅ 4.5mm			4.5 mm	49975.0004
	Resector smooth ∅ 5.5mm			5.5 mm	49975.0005
	Resector toothed ∅ 3.5mm	ocher	130 mm	3.5 mm	49975.0033
	Resector toothed ∅ 4.5mm			4.5 mm	49975.0034
	Resector toothed ∅ 5.5mm			5.5 mm	49975.0035
	Resector aggress ∅ 2.5mm	red	80 mm	2.5 mm	499750332
	Resector aggress ∅ 3.5mm		130 mm	3.5 mm	49975.0333
	Resector aggress ∅ 4.5mm			4.5 mm	49975.0334
	Resector aggress ∅ 5.5mm			5.5 mm	49975.0335
	Resector oval ∅ 3.5mm	white	130 mm	3.5 mm	49975.0113
	Resector oval ∅ 4.5mm			4.5 mm	49975.0114
	Resector oval ∅ 5.5mm			5.5 mm	49975.0115

Disposable Shaver Blades and Burrs

for Power Stick M5/3 and M5/0 shaver handle





	Disposable (5 PCS, in individual sterile packaging)	Color coding	WL	Ø	Product no.
	Resector convex curved smooth Ø 3.5mm	canary yellow	130 mm	3.5 mm	49975.0253
	Resector convex curved smooth Ø 4.5mm			4.5 mm	49975.0254
	Resector convex curved smooth Ø 5.5mm			5.5 mm	49975.0255
	Resector concave curved smooth Ø 3.5mm	canary yellow	130 mm	3.5 mm	49975.0263
	Resector concave curved smooth Ø 4.5mm			4.5 mm	49975.0264
	Resector concave curved smooth Ø 5.5mm			5.5 mm	49975.0265
	End cutter Ø4.5 mm	black	130 mm	4.5 mm	49975.0494
 with lateral protection	Burr round Ø 4.5mm	gulf blue	130 mm	4.5 mm	49975.0504
 no hood	Burr round Ø 6mm	gulf blue	130 mm	6.0 mm	49975.0516
 with lateral protection	Acromionizer Ø 3.5mm	purple	130 mm	3.5 mm	49975.0553
	Acromionizer Ø 4.5mm			4.5 mm	49975.0554
	Acromionizer Ø 5.5mm			5.5 mm	49975.0555
	Acromionizer Ø 6.5mm			6.5 mm	49975.0556

Disposable Shaver Blades and Burrs

for Power Stick M5/3 and M5/0 shaver handle

for hip arthroscopy





	Disposable (5 PCS, in individual sterile packaging)	Color coding	WL	∅	Product no.
	Resector curved universal ∅ 4.5mm	gray	160 mm	4.5 mm	499732274
 with 2 mm retracted lateral protection	Resector universal ∅ 4.5mm	gray	160 mm	4.5 mm	499732344
 with 2 mm retracted lateral protection	Burr oval ∅ 5.5mm	purple	160 mm	5.5 mm	499732565

Disposable Shaver Blades and Burrs

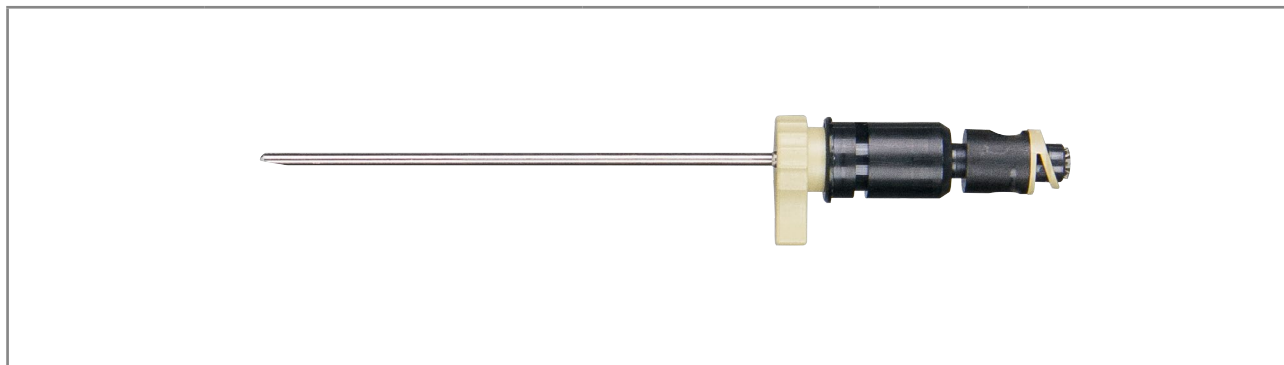
for Micro Stick S1



	Disposable (5 PCS, in individual sterile packaging)	Color coding	WL	∅	Product no.
	Resector toothed ∅ 2mm	ocher	45 mm	2.0 mm	49971.0032
	Resector toothed ∅ 3.5mm		130 mm	3.5 mm	49971.0033
	Resector aggress ∅ 2.5mm	red	80 mm	2.5 mm	499710332
	Resector oval ∅ 3.5mm	white	130 mm	3.5 mm	49971.0113
 with lateral protection	Burr round ∅ 3mm	gulf blue	130 mm	3.0 mm	49971.0503
 with lateral protection	Burr oval ∅ 3.5mm	canary yellow	130 mm	3.5 mm	49971.0553

