

INSTRUCTIONS



EVIS EXERA II GASTROINTESTINAL VIDEOSCOPE

OLYMPUS GIF TYPE N180

OLYMPUS GIF TYPE Q180

OLYMPUS GIF TYPE H180

EVIS EXERA II COLONOVIDEOSCOPE

OLYMPUS CF TYPE Q180AL/I

OLYMPUS CF TYPE H180AL/I

OLYMPUS PCF TYPE Q180AL/I

Refer to the endoscope's companion manual, the "REPROCESSING MANUAL" whose cover lists the model of your endoscope, for reprocessing information.

USA: CAUTION: Federal law restricts this device to sale by or on the order of a physician.

CE 0197

Contents

Symbols	1
Important Information — Please Read Before Use	2
Intended use	2
Applicability of endoscopy and endoscopic treatment	3
Instruction manual	3
User qualifications	4
Instrument compatibility	4
Reprocessing before the first use/reprocessing and storage after use	4
Spare equipment.....	5
Maintenance management	5
Prohibition of improper repair and modification	5
Signal words	5
Warnings and cautions	6
Examples of inappropriate handling.....	11
Chapter 1 Checking the Package Contents	12
Chapter 2 Instrument Nomenclature and Specifications	16
2.1 Nomenclature.....	16
2.2 Endoscope functions.....	22
2.3 Specifications.....	24
2.4 Attaching the chain for water-resistant cap (MAJ-1119).....	32
Chapter 3 Preparation and Inspection	35
3.1 Preparation of the equipment.....	36
3.2 Inspection of the endoscope	37
3.3 Preparation and inspection of accessories	43
3.4 Attaching accessories to the endoscope	47
3.5 Inspection and connection of ancillary equipment	50
3.6 Inspection of the endoscopic system.....	53
Chapter 4 Operation	58
4.1 Insertion	62
4.2 Using endo-therapy accessories.....	70
4.3 Withdrawal of the endoscope.....	76
4.4 Transportation of the endoscope	77

Chapter 5 Troubleshooting	79
5.1 Troubleshooting guide	79
5.2 Withdrawal of the endoscope with an abnormality.....	83
5.3 Returning the endoscope for repair.....	86
Appendix.....	87
System chart	87
EMC information.....	101

Symbols

The meaning(s) of the symbol(s) shown on the package with the components, the back cover of this instruction manual and/or this instrument are as follows:



Refer to instructions.



Endoscope



TYPE BF applied part



Single use only



Lot number



Manufacturer



Authorized representative in the European Community

Important Information — Please Read Before Use

Intended use

These instruments have been designed to be used with an Olympus video system center, light source, documentation equipment, video monitor, endo-therapy accessories such as a biopsy forceps and other ancillary equipment.

Use the EVIS EXERA II GASTROINTESTINAL VIDEOSCOPE GIF-N180 for transoral or transnasal endoscopy and endoscopic surgery within the upper digestive tract (including the esophagus, stomach and duodenum).

Use the EVIS EXERA II GASTROINTESTINAL VIDEOSCOPE, GIF-Q180, GIF-H180 for endoscopy and endoscopic surgery within the upper digestive tract (including the esophagus, stomach and duodenum).

Use the EVIS EXERA II COLONOVIDEOSCOPE CF-Q180AL/I, CF-H180AL/I, PCF-Q180AL/I for endoscopy and endoscopic surgery within the lower digestive tract (including the anus, rectum, sigmoid colon, colon and ileocecal valve).

Do not use these instruments for any purpose other than their intended uses. Select the endoscope to be used according to the objective of the intended procedure based on the full understanding of the endoscope's specifications and functionality as described in this instruction manual.

Applicability of endoscopy and endoscopic treatment

If there is an official standard on the applicability of endoscopy and endoscopic treatment that is defined by the hospital's administration or other official institutions such as academic societies on endoscopy, follow that standard. Before starting endoscopy and endoscopic treatment, thoroughly evaluate its properties, purposes, effects, and possible risk (their natures, extent and probability). Perform endoscopy and endoscopic treatment only when its potential benefits are greater than its risks.

Fully explain to the patient the potential benefits and risks of the endoscopy and endoscopic treatment as well as any examination/treatment methods that can be performed in its place, and perform the endoscopy and endoscopic treatment only after obtaining the consent of the patient.

Even after starting the endoscopy and endoscopic treatment, continue to evaluate the potential benefits and risks, and immediately stop the endoscopy/treatment and take proper measures if the risks to the patient become greater than the potential benefits.

Instruction manual

This instruction manual contains essential information on using this instrument safely and effectively. Before use, thoroughly review this manual and the manuals of all equipment which will be used during the procedure and use the equipment as instructed.

Note that the complete instruction manual set for this endoscope consists of this manual and the "REPROCESSING MANUAL" whose cover lists the model of your endoscope. It also accompanied the endoscope at shipment.

Keep this and all related instruction manuals in a safe, accessible location. If you have any questions or comments about any information in this manual, please contact Olympus.

User qualifications

If there is an official standard on user qualifications to perform endoscopy and endoscopic treatment that is defined by the medical administration or other official institutions, such as academic societies on endoscopy, follow that standard. If there is no official qualification standard, the operator of this instrument must be a physician approved by the medical safety manager of the hospital or person in charge of the department (department of internal medicine, etc.).

The physician should be capable of safely performing the planned endoscopy and endoscopic treatment following guidelines set by the academic societies on endoscopy, etc., and considering the difficulty of endoscopy and endoscopic treatment. This manual does not explain or discuss endoscopic procedures.

Instrument compatibility

Refer to the “System chart” in the Appendix to confirm that this instrument is compatible with the ancillary equipment being used. Using incompatible equipment can result in patient or operator injury and/or equipment damage.

This instrument complies with EMC standard for medical electrical equipment; edition 2 (IEC 60601-1-2: 2001). However, when connected with an instrument that complies with EMC standard for medical electrical equipment; edition 1 (IEC 60601-1-2: 1993), the whole system complies with edition 1.

Reprocessing before the first use/reprocessing and storage after use

This instrument was not cleaned, disinfected or sterilized before shipment. Before using this instrument for the first time, reprocess it according to the instructions given in the endoscope’s companion manual, the “REPROCESSING MANUAL” whose cover lists the model of your endoscope. After using this instrument, reprocess and store it according to the instructions given in the endoscope’s companion reprocessing manual. Improper and/or incomplete reprocessing or storage can present an infection-control risk, cause equipment damage or reduce performance.

Spare equipment

Be sure to prepare another endoscope to avoid that the examination will be interrupted due to equipment failure or malfunction.

Maintenance management

The probability of failure of the endoscope and ancillary equipment increases as the number of procedures performed and/or the total operating hours increase. In addition to the inspection before each procedure, the person in charge of medical equipment maintenance in each hospital should inspect the items specified in this manual periodically. An endoscope with which an irregularity is suspected should not be used, but should be inspected by following Section 5.1, “Troubleshooting guide” on page 79. If the irregularity is still suspected after inspection, contact Olympus.

Prohibition of improper repair and modification

This instrument does not contain any user-serviceable parts. Do not disassemble, modify or attempt to repair it; patient or operator injury and/or equipment damage can result.

Equipment which has been disassembled, repaired, altered, changed or modified by persons other than Olympus’ own authorized service personnel is excluded from Olympus’ limited warranty and is not warranted by Olympus in any manner.

Signal words

The following signal words are used throughout this manual:

WARNING

Indicates a potentially hazardous situation which, if not avoided, could result in death or serious injury.

CAUTION

Indicates a potentially hazardous situation which, if not avoided, may result in minor or moderate injury. It may also be used to alert against unsafe practices or potential equipment damage.

NOTE

Indicates additional helpful information.

Warnings and cautions

Follow the warnings and cautions given below when handling this instrument. This information is to be supplemented by the warnings and cautions given in each chapter.

WARNING

- After using this instrument, reprocess and store it according to the instructions given in the endoscope's companion reprocessing manual whose cover lists the model of your endoscope. Using improperly or incompletely reprocessed or stored instruments may cause patient cross-contamination and/or infection.
- Before endoscopy, remove any metallic objects (watch, glasses, necklace, etc.) from the patient. If performing high-frequency cauterization becomes necessary while the patient wears a metallic object, it may cause burns on the patient in areas around the metallic object.
- Do not strike, bend, hit, pull, twist, or drop the endoscope's distal end, insertion tube, bending section, control section, universal cord, or endoscope connector of the endoscope with excessive force. The endoscope may be damaged and could cause patient injury, burns, bleeding and/or perforations. It could also cause parts of the endoscope to fall off inside the patient.
- When performing transnasal insertion of the GIF-N180, please follow the cautions below.
 - The shape and size of the nasal cavity and its suitability for transnasal insertion may vary from patient to patient. No endoscope, including this one, can always be inserted transnasally with all patients. Before proceeding, always be sure to confirm that transnasal insertion is possible with the patient. Otherwise, operator and/or patient injury can result, or the endoscope could become lodged and be difficult to withdraw.

- Transnasal insertion is accompanied by the risk of inflammation of the nasal cavity. If this happens, the nasal passage will be constricted, making it more difficult to withdraw the endoscope. In this case, do not use force to withdraw the endoscope because patient injury such as bleeding or perforation may result.
- Transnasal insertion is accompanied by the risk of bleeding in the nasal cavity. Be sure to be prepared to deal with any bleeding. When withdrawing the endoscope, observe the inside of the nasal cavity to ensure that there is no bleeding. Even when the endoscope has been withdrawn without bleeding, do not allow the patient to blow his or her nose strongly because this could cause it to start bleeding.
- Before transnasal insertion, apply the appropriate pretreatment and lubrication to the patient to enlarge the nasal cavity. Otherwise, operator and/or patient injury can result or the endoscope could become lodged and be difficult to withdraw. When applying a pretreatment agent through a tube, insert the tube into the same path as the path planned for the endoscope insertion. Otherwise, the treatment will have no effect. The effects of the pretreatment agent and lubricant will decrease the longer the procedure lasts. Apply the pretreatment agent or lubricant as required during the procedure – for example, when withdrawal seems to be difficult.
- Transnasal insertion of the endoscope should be performed carefully. If resistance to insertion is felt, or the patient reports pain, stop insertion immediately. Otherwise, operator and/or patient injury can result or the endoscope could become lodged and be difficult to withdraw.
- If it becomes impossible to withdraw the transnasally inserted endoscope, pull its distal end out of the mouth, cut the flexible tube using wire cutters, and after ensuring that the cut section will not injure the body cavity or nasal cavity of the patient, withdraw the endoscope carefully. Therefore, always prepare wire cutters in advance.
- Never perform angulation control forcibly or abruptly. Never forcefully pull, twist or rotate the angulated bending section. Patient injury, bleeding and/or perforation can result. It may also become impossible to straighten the bending section during an examination.

- Never insert or withdraw the endoscope's insertion tube while the bending section is locked in position. Patient injury, bleeding and/or perforation can result.
- Never perform flexibility adjustment, operate the bending section, feed air or perform suction, insert or withdraw the endoscope's insertion tube, or use endo-therapy accessories without viewing the endoscopic image. Patient injury, bleeding and/or perforation can result.
- Never perform flexibility adjustment, operate the bending section, feed air or perform suction, insert or withdraw the endoscope's insertion tube, or use endo-therapy accessories while the image is frozen. Patient injury, bleeding and/or perforation can result.
- Regardless of the flexibility of the endoscope's insertion tube, never insert or withdraw the insertion tube abruptly or with excessive force. Patient injury, bleeding and/or perforation can result.
- Never insert or withdraw the endoscope's insertion tube, use endo-therapy accessories while the image is magnified. Patient injury, bleeding and/or perforation can result (only when using the image magnification of the video system center CV-180).
- Do not touch the light guide of the endoscope connector immediately after removing it from the light source because it is extremely hot. Operator or patient burns can result.
- When the endoscopic image does not appear on the monitor, the CCD may have been damaged. Turn the video system center OFF immediately. Continued power supply in such a case will cause the distal end to become hot and could cause operator and/or patient burns.
- If it is difficult to insert the endoscope, do not forcibly insert the endoscope; stop the endoscopy. Forcible insertion can result in patient injury, bleeding and/or perforation.
- When combining the endoscope with a splinting tube, there is the risk of perforation or bleeding due to entanglement of the mucous membrane, or of the tube to becoming separated from the endoscope and remaining in the body. Before use, be sure to read the instruction manual for the splinting tube to fully understand its characteristics.

- For reasons described below, do not rely on the NBI*¹ imaging modality alone for primary detection of lesions or to make a decision regarding any potential diagnostic or therapeutic intervention.
 - It has not been demonstrated to increase the yield or sensitivity of finding any specific mucosal lesion including colonic polyps or Barrett's esophagus.
 - It has not been demonstrated to aid in differentiating establishing the presence or absence of dysplasia or neoplastic changes within mucosa or mucosal lesions.

*1 NBI stands for Narrow Band Imaging. For more details, refer to the instruction manual of the CV-180.

CAUTION

- Do not pull the universal cord during an examination. The endoscope connector will be pulled out from the output socket of the light source and the endoscopic image will not be visible.
- Do not coil the insertion tube or universal cord with a diameter of less than 12 cm. Equipment damage can result.
- Do not touch the electrical contacts inside the electrical connector. CCD damage may result.
- Do not apply shock to the distal end of the insertion tube, particularly the objective lens surface at the distal end. Visual abnormalities may result.
- Do not twist or bend the bending section with your hands. Equipment damage may result.
- Do not squeeze the bending section forcefully. The covering of the bending section may stretch or break and cause water leaks.
- Turn the video system center OFF before connecting or disconnecting the videoscope cable from the electrical connector on the endoscope. Turn the video system center ON or OFF only when the videoscope cable is connected to both the video system center and the electrical connector on the endoscope. Failure to do so can result in equipment damage, including destruction of the CCD.
- The endoscope's remote switches cannot be removed from the control section. Pressing, pulling or twisting them with excessive force can break the switches and/or may cause water leaks.

- If remote switch 1 does not return to the OFF position after being pressed strongly from the side, gently pull the switch upwards to return it to the OFF position.
- Do not hit or bend the electrical contacts on the endoscope connector. The connection to the light source may be impaired and faulty contact can result.
- Do not attempt to bend the endoscope's insertion tube with excessive force. Otherwise, the insertion tube may be damaged.
- Do not attempt to bend the endoscope's insertion tube with excessive force unless its flexibility is set to the most-rigid position. Otherwise, the insertion tube may be damaged (for endoscopes with flexibility adjustment only).
- To check the electromagnetic influence from other equipment (any equipment other than this instrument or the components that constitute this system), the system should be observed to verify its normal operation in the configuration in which it will be used.
- Electromagnetic interference may occur on this instrument near equipment marked with the following symbol or other portable and mobile RF (Radio Frequency) communications equipment such as cellular phones. If electromagnetic interference occurs, mitigation measures may be necessary, such as reorienting or relocating this instrument, or shielding the location.



NOTE

This endoscope contains a memory chip that stores information about the endoscope and communicates this information to the video system center CV-160 and CV-180.

Examples of inappropriate handling

Details on clinical endoscopic technique are the responsibility of trained specialists. Patient safety in endoscopic examinations and endoscopic treatment can be ensured through appropriate handling by the physician and the medical facility. Examples of inappropriate handling are described below;

- Over-insufflating the lumen may cause patient pain, injury, bleeding and/or perforation.
- Applying suction with the distal end in prolonged contact with the mucosal surface, with higher suction pressure than required or with prolonged suction time may cause bleeding and/or lesions.
- The endoscope has not been designed for use in retroflexed observation in parts of the body other than the stomach. Performing retroflexed observation in a narrow lumen may make it impossible to straighten and/or withdraw the endoscope. Retroflexed observation in parts of the body other than the stomach should be performed only when the usefulness of doing so is determined to be greater than the risk that is posed to the patient.
- Inserting, withdrawing and using endo-therapy accessories without a clear endoscopic image may cause patient injury, burns, bleeding and/or perforation.
- Inserting or withdrawing the endoscope, feeding air, applying suction or operating the bending section without a clear endoscopic image may cause patient injury, bleeding and/or perforation.

Chapter 1 Checking the Package Contents

Match all items in the package with the components shown below. Inspect each item for damage. If the instrument is damaged, a component is missing or you have any questions, do not use the instrument; immediately contact Olympus. This instrument was not disinfected or sterilized before shipment.

Before using this instrument for the first time, reprocess it according to the instructions described in the endoscope's companion manual, the "REPROCESSING MANUAL" whose cover lists the model of your endoscope.

GIF-N180

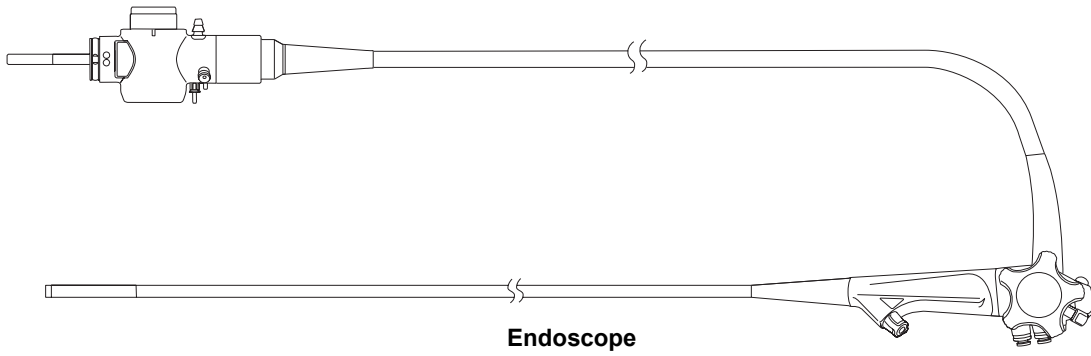

GIF-Q180, GIF-H180

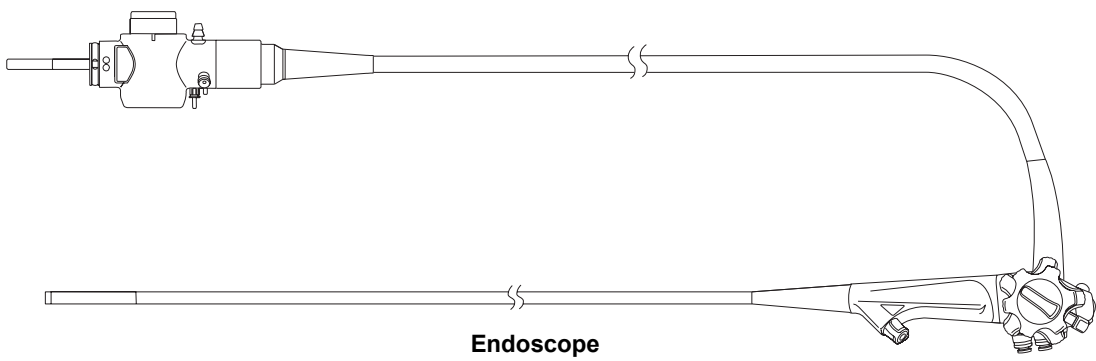

CF-Q180AL/I, CF-H180AL/I, PCF-Q180AL/I

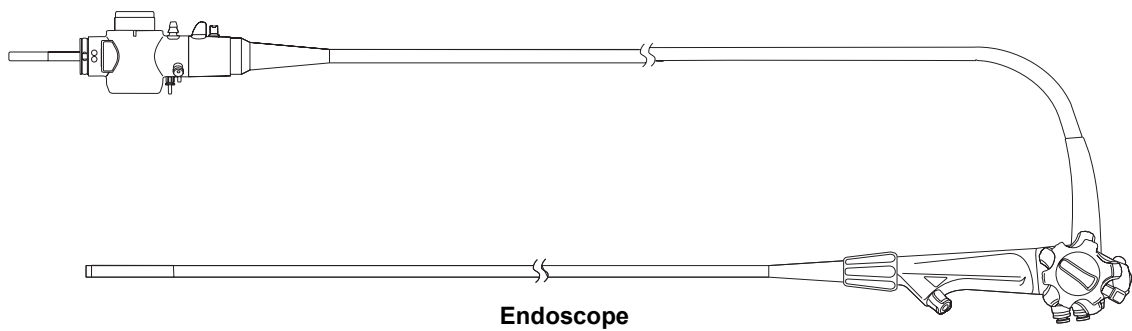

Packaged for the USA and CAN

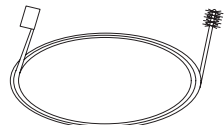

Single use channel cleaning brush (BW-201T) (3 pcs)

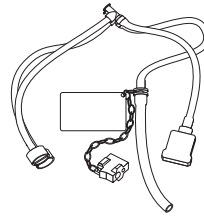

Injection tube (MH-946)

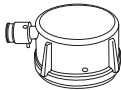

Water-resistant cap (MH-553)



AW channel cleaning adapter (MH-948)



Chain for water-resistant cap (MAJ-1119)

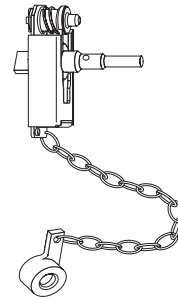

Channel plug (MH-944)



Biopsy valve (MB-358) (10 pcs)



Single use channel-opening cleaning brush (MAJ-1339) (3 pcs)



Suction cleaning adapter (MH-856)



Suction valve (MH-443) (2 pcs)



Air/water valve (MH-438) (2 pcs)

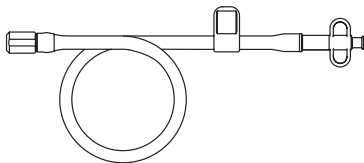

Auxiliary water tube (MAJ-855 for endoscopes with auxiliary water feeding only)



Mouthpiece (MB-142 for GIF-Q180, GIF-H180) (2 pcs)



Mouthpiece (MA-474, MB-142 for GIF-N180) (1 pc each)

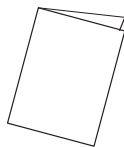

Operation manual

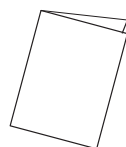

Reprocessing manual

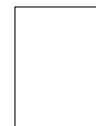

Instructions (leaflet type, for endoscopes with flexibility adjustment only)

Packaged for countries other than the USA and CAN

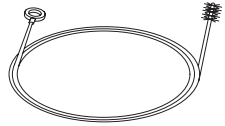

Channel cleaning brush (BW-20T)

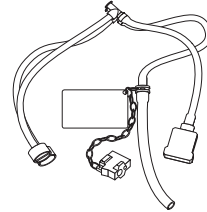

Injection tube (MH-946)

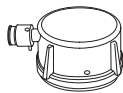

Water-resistant cap (MH-553)



AW channel cleaning adapter (MH-948)



Channel-opening cleaning brush (MH-507)



Biopsy valve (MB-358) (10 pcs)

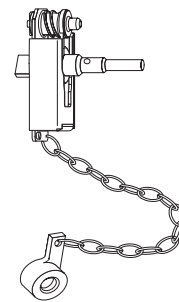

Channel plug (MH-944)



Suction cleaning adapter (MH-856)



Suction valve (MH-443) (2 pcs)



Air/water valve (MH-438) (2 pcs)

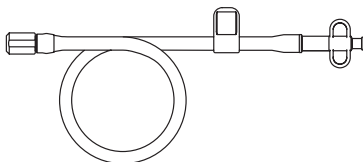

Auxiliary water tube (MAJ-855 for endoscopes with auxiliary water feeding only)



Mouthpiece (MB-142 for GIF-Q180, GIF-H180) (2 pcs)



Mouthpiece (MA-474, MB-142 for GIF-N180) (1 pc each)

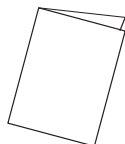

Operation manual

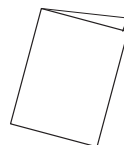

Reprocessing manual



Instructions (leaflet type, for endoscopes with flexibility adjustment only)

Chapter 2 Instrument Nomenclature and Specifications

2.1 Nomenclature

○ GIF-N180

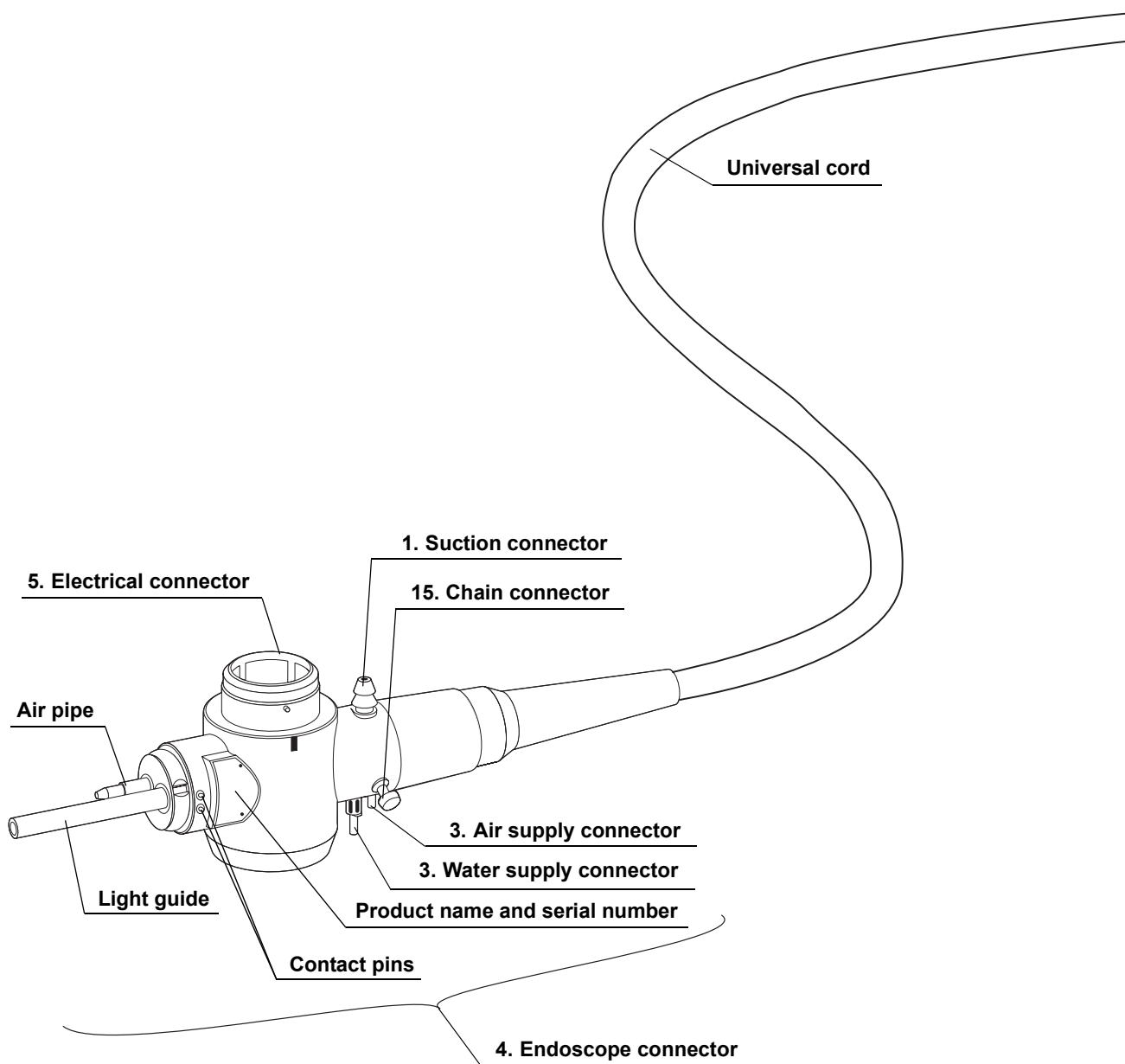

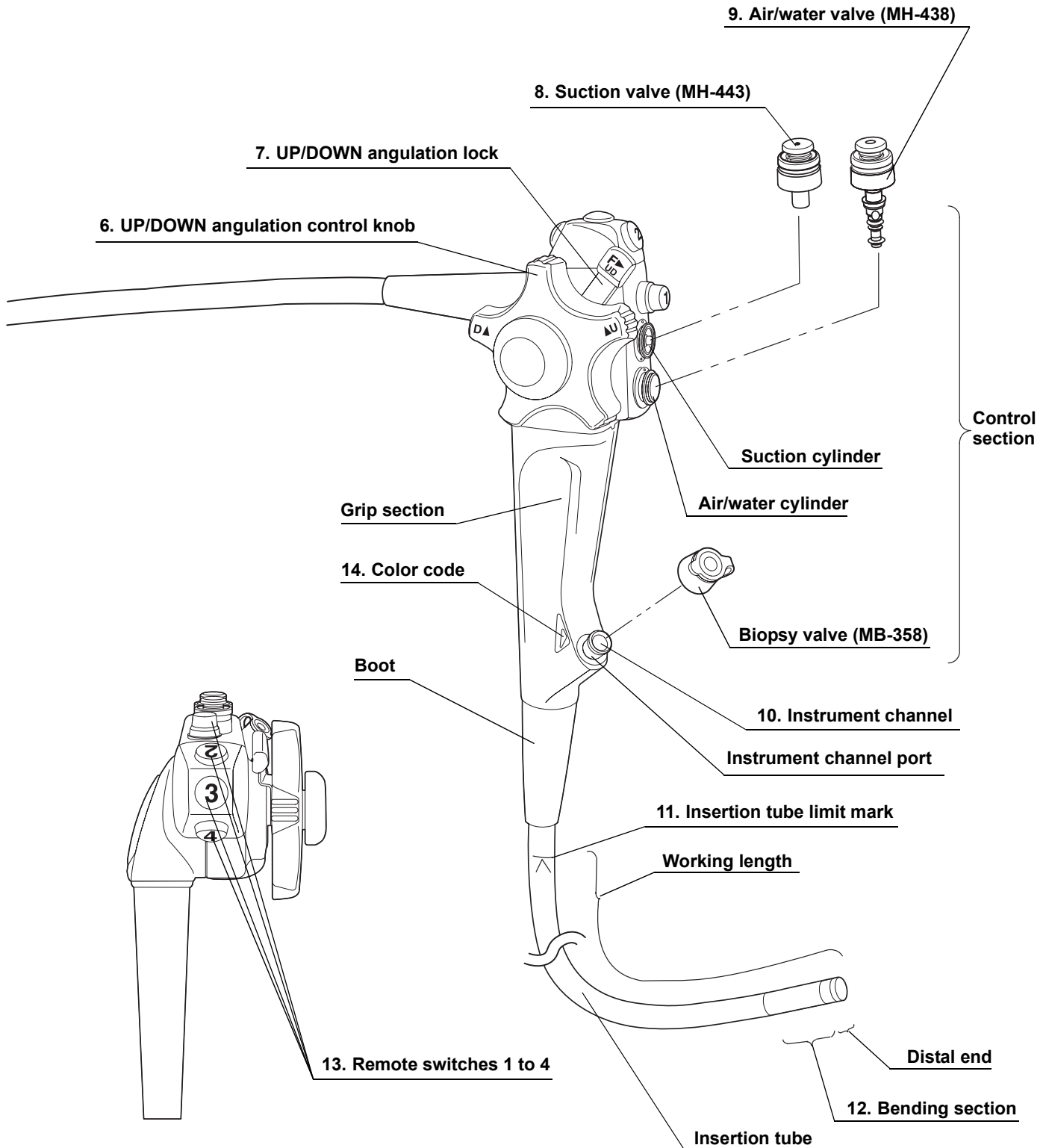

○ GIF-Q180, GIF-H180

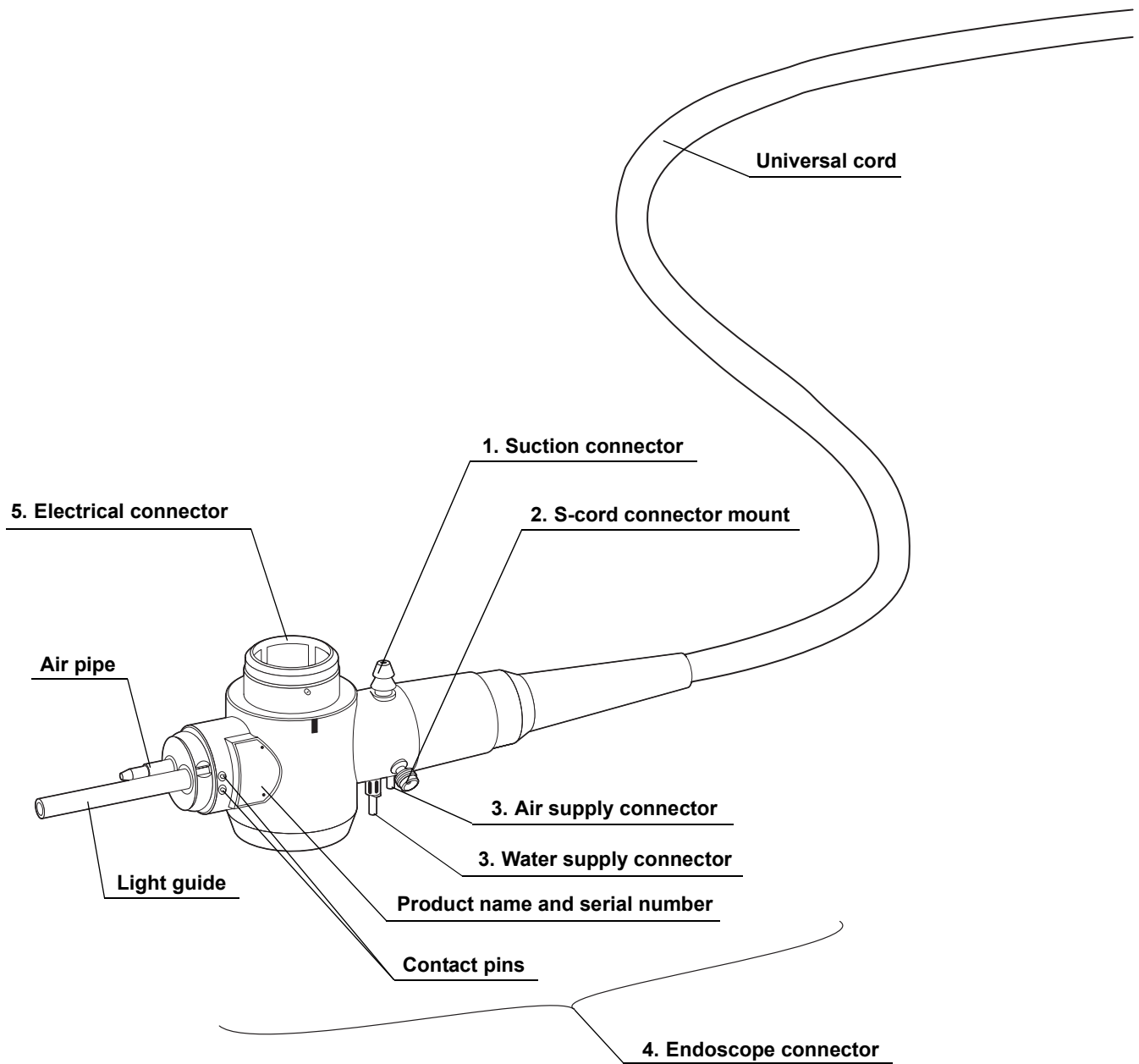

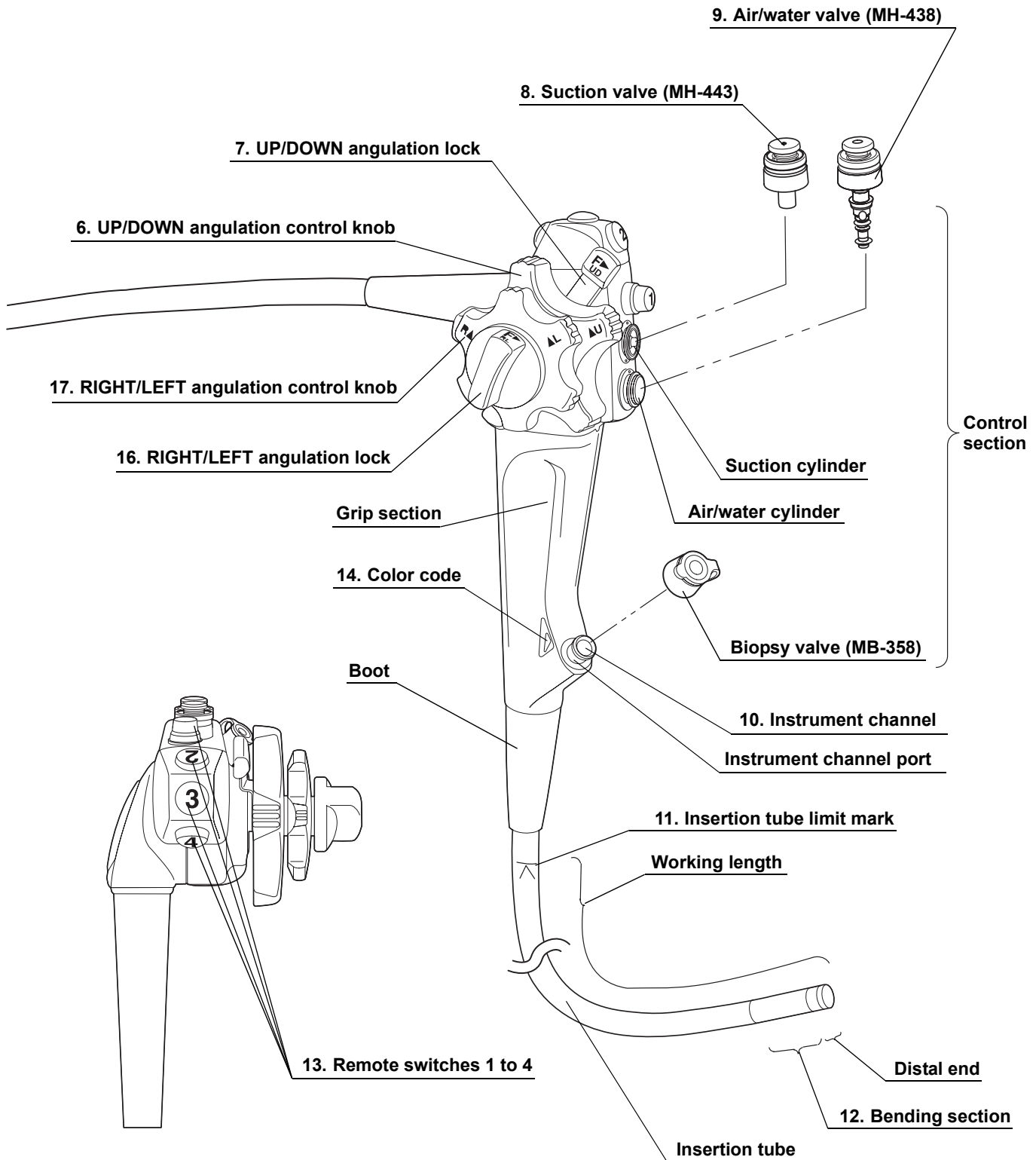

○ CF-Q180AL, CF-Q180AI, CF-H180AL, CF-H180AI,
PCF-Q180AL, PCF-Q180AI

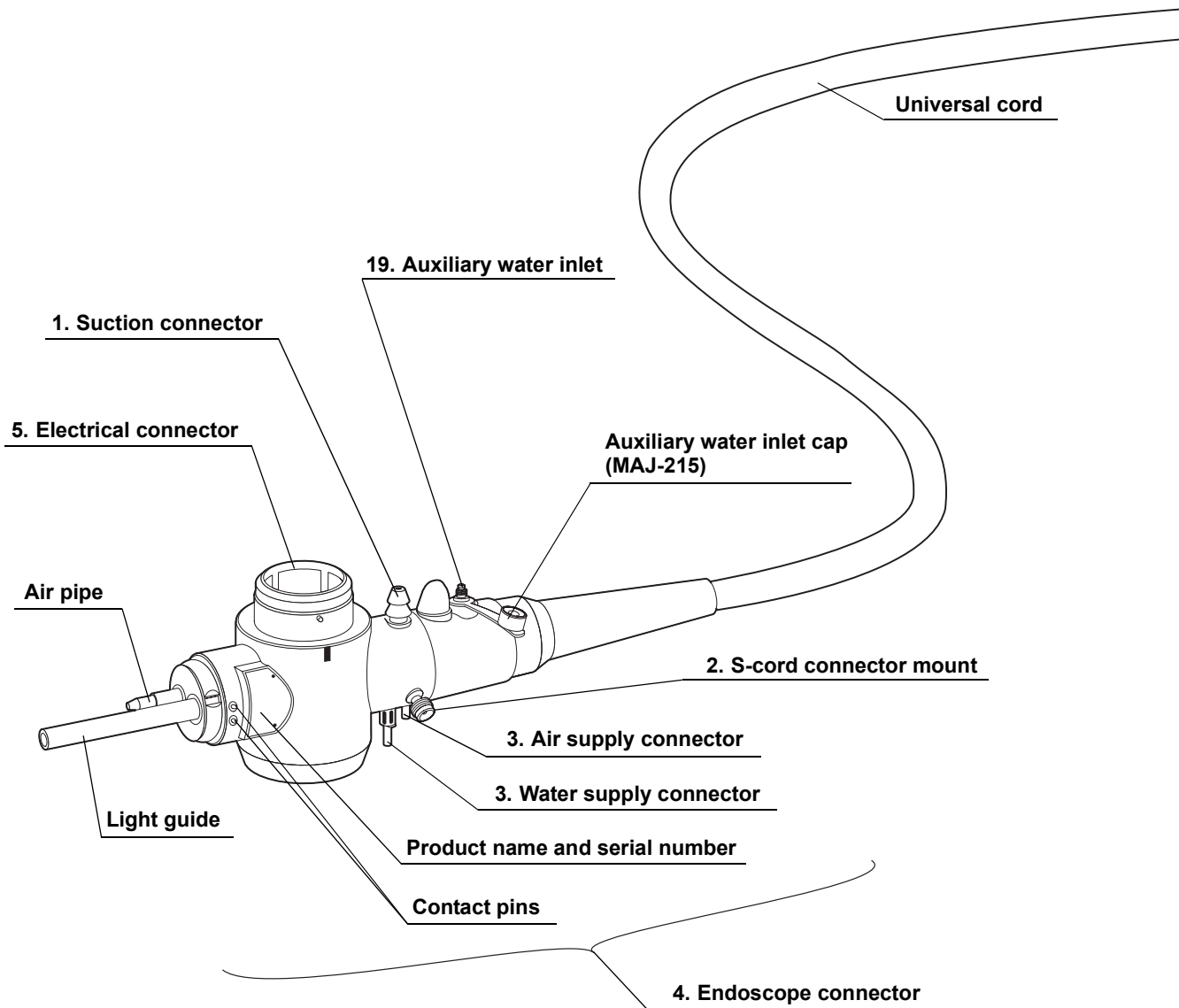

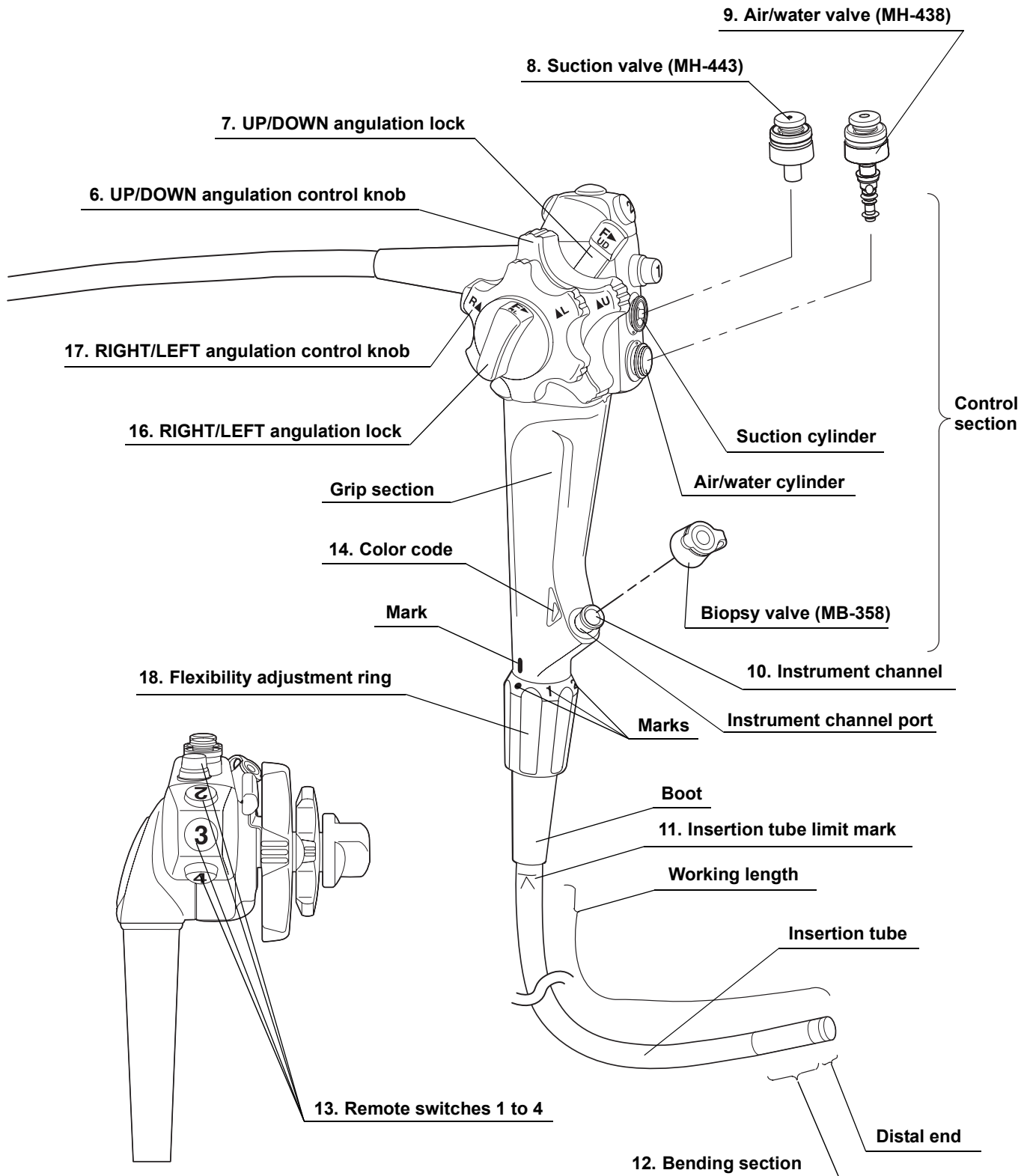

2.2 Endoscope functions

- 1. Suction connector**
Connects the endoscope to the suction tube of the suction pump.
- 2. S-cord connector mount (except GIF-N180)**
Connects the endoscope with the Olympus electrosurgical unit via the S-cord. The S-cord conducts leakage current from the endoscope to the electrosurgical unit. To connect the S-cord, refer to the instruction manual for the electrosurgical unit. Connect the fitting of the chain for water-resistant cap to this mount as required (see Section 2.4 on page 32).
- 3. Water supply connector and air supply connector**
Connects the endoscope to the water container via the water container tube, to supply water to the distal end of the endoscope.
- 4. Endoscope connector**
Connects the endoscope to the output socket of the light source and transmits light from the light source to the endoscope.
- 5. Electrical connector**
Connects the endoscope to the video system center via the videoscope cable. The endoscope contains a memory chip that stores information about the endoscope and communicates this information to the video system center CV-160 and CV-180. For more details, refer to the instruction manual of the CV-160 or CV-180.
- 6. UP/DOWN angulation control knob**
When this knob is turned in the “▲U” direction, the bending section moves UP; when the knob is turned in the “D▲” direction, the bending section moves DOWN.
- 7. UP/DOWN angulation lock**
Moving this lock in the “F▶” direction frees angulation. Moving the lock in the opposite direction locks the bending section at any desired position.
- 8. Suction valve (MH-443)**
This valve is depressed to activate suction. The valve is used to remove any fluid, debris, flatus or air from the patient.
- 9. Air/water valve (MH-438)**
The hole in this valve is covered to insufflate air and the valve is depressed to feed water for lens washing. It also can be used to feed air to remove any fluid or debris adhering to the objective lens.
- 10. Instrument channel**
The instrument channel functions as:
 - channel for the insertion of endo-therapy accessories
 - suction channel
 - fluid feed channel (from a syringe via the biopsy valve)

11. Insertion tube limit mark

This mark shows the maximum point to which the endoscope may be inserted into the patient's body.

12. Bending section

This section moves the distal end of the endoscope when the UP/DOWN and RIGHT/LEFT angulation control knobs are operated (the GIF-N180 has only the UP/DOWN angulation control knob).

13. Remote switches 1 to 4

The functions of the remote switches 1 to 4 can be selected on the video system center. When selecting the functions, also refer to the instruction manual for the video system center.

14. Color code

This code is used to quickly determine the compatibility of endo-therapy accessories. The endoscope can be used with endo-therapy accessories that have the same color code.

- Blue: GIF-N180
- Yellow: GIF-Q180, GIF-H180, PCF-Q180AL/I
- Orange: CF-Q180AL/I, CF-H180AL/I

15. Chain connector (for GIF-N180 only)

Connect the fitting of the chain for water-resistant cap here. Do not connect the S-cord of the electrosurgical unit here.

16. RIGHT/LEFT angulation lock (except GIF-N180)

Turning this lock in the "F▶" direction frees angulation. Turning the lock in the opposite direction locks the bending section at any desired position.

17. RIGHT/LEFT angulation control knob (except GIF-N180)

When this knob is turned in the "R▲" direction, the bending section moves RIGHT; when the knob is turned in the "▲L" direction, the bending section moves LEFT.

18. Flexibility adjustment ring (for endoscopes with flexibility adjustment only)

Turn this ring to adjust the flexibility of the insertion tube.

When the "●" mark on the ring is aligned with the "I" mark at the bottom of the grip section, the insertion tube is the most flexible. To decrease the flexibility, turn the ring so that the numbers are aligned with the "I" mark ("3" corresponds to the most-rigid condition). As the ring is turned from "●" to "3", the insertion tube's flexibility gradually decreases.

19. Auxiliary water inlet (for endoscopes with auxiliary water feeding only)

Connect the auxiliary water tube here. Feed water from this inlet through the auxiliary water channel when necessary, (e.g. when blood adheres to mucous membrane in the patient's body cavity). When the auxiliary water inlet is not being used, make sure that it is covered by the auxiliary water inlet cap.

2.3 Specifications

Environment

Operating environment	Ambient temperature	10 – 40°C (50 – 104°F)
	Relative humidity	30 – 85%
	Atmospheric pressure	700 – 1060 hPa (0.7 – 1.1 kgf/cm ²) (10.2 – 15.4 psia)
Transportation and storage environment	Ambient temperature	–47 to 70°C (–52.6 to 158°F)
	Relative humidity	10 – 95%
	Atmospheric pressure	700 – 1060 hPa (0.7 – 1.1 kgf/cm ²) (10.2 – 15.4 psia)

Specifications

○ Endoscope functions

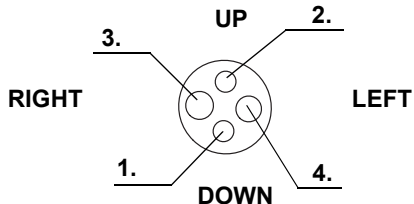
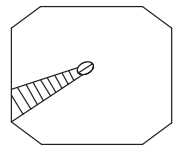
Model	GIF-N180*1	
Optical system	Field of view	120°
	Direction of view	Forward viewing
	Depth of field	3 – 100 mm
Insertion tube	Distal end outer diameter	ø 4.9 mm
	Distal end enlarged	1. Air/water nozzle 2. Light guide lens 3. Objective lens 4. Instrument channel outlet
		
	Insertion tube outer diameter	ø 4.9 mm
	Working length	1100 mm
Instrument channel	Channel inner diameter	ø 2 mm
	Minimum visible distance	2 mm from the distal end
	Direction from which endo-therapy accessories enter and exit the endoscopic image	
Air flow rate	25 cm ³ /s Note: Standard when CLV-180 (high air pressure) is used.	
Bending section	Angulation range	UP 210°, DOWN 120°
Total length	1420 mm	
NBI*2	Available	

*1 GIF-N180 cannot be used to perform high-frequency cauterization or laser cauterization.

*2 NBI stands for Narrow Band Imaging. For more details, refer to the instruction manual of the CV-180.

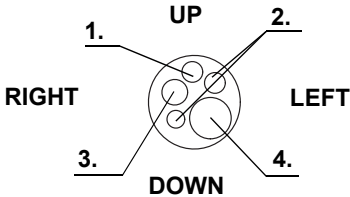
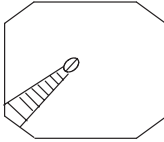
Model	GIF-Q180	
Optical system	Field of view	140°
	Direction of view	Forward viewing
	Depth of field	3 – 100 mm
Insertion tube	Distal end outer diameter	ø 8.8 mm
	Distal end enlarged	<ol style="list-style-type: none"> 1. Air/water nozzle 2. Light guide lens 3. Objective lens 4. Instrument channel outlet
		
	Insertion tube outer diameter	ø 8.8 mm
	Working length	1030 mm
Instrument channel	Channel inner diameter	ø 2.8 mm
	Minimum visible distance	3 mm from the distal end
	Direction from which endo-therapy accessories enter and exit the endoscopic image	
Air flow rate	25 cm ³ /s	Note: Standard when CLV-180 (high air pressure) is used.
Bending section	Angulation range	UP 210°, DOWN 90°, RIGHT 100°, LEFT 100°
Total length	1345 mm	
NBI*1	Available	

*1 NBI stands for Narrow Band Imaging. For more details, refer to the instruction manual of the CV-180.

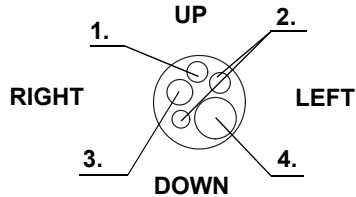
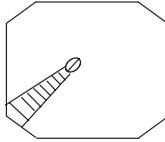
Model	GIF-H180	
Optical system	Field of view	140°
	Direction of view	Forward viewing
	Depth of field	2 – 100 mm
Insertion tube	Distal end outer diameter	ø 9.8 mm
	Distal end enlarged	1. Air/water nozzle 2. Light guide lens 3. Objective lens 4. Instrument channel outlet
		
	Insertion tube outer diameter	ø 9.8 mm
	Working length	1030 mm
Instrument channel	Channel inner diameter	ø 2.8 mm
	Minimum visible distance	3 mm from the distal end
	Direction from which endo-therapy accessories enter and exit the endoscopic image	
Air flow rate	25 cm ³ /s Note: Standard when CLV-180 (high air pressure) is used.	
Bending section	Angulation range	UP 210°, DOWN 90°, RIGHT 100°, LEFT 100°
Total length	1345 mm	
NBI^{*1}	Available	

*1 NBI stands for Narrow Band Imaging. For more details, refer to the instruction manual of the CV-180.

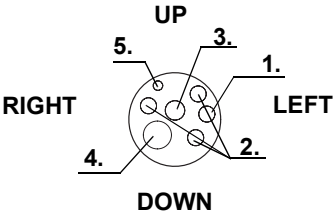
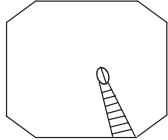
Model	CF-Q180AL	CF-Q180AI
Optical system	Field of view	170°
	Direction of view	Forward viewing
	Depth of field	3 – 100 mm
Insertion tube	Distal end outer diameter	ø 13.2 mm
	Distal end enlarged	<ol style="list-style-type: none"> 1. Air/water nozzle 2. Light guide lens 3. Objective lens 4. Instrument channel outlet 5. Auxiliary water channel
		
Insertion tube outer diameter		ø 12.8 mm
Working length		L: 1680 mm I: 1330 mm
Range of the flexibility adjustment		The rigidity in the most-rigid condition is about twice that in the most-flexible condition.
Instrument channel	Channel inner diameter	ø 3.7 mm
	Minimum visible distance	3 mm from the distal end
	Direction from which endo-therapy accessories enter and exit the endoscopic image	
Air flow rate	25 cm ³ /s	
Note: Standard when CLV-180 (high air pressure) is used.		
Bending section	Angulation range	UP 180°, DOWN 180°, RIGHT 160°, LEFT 160°
Total length		L: 2005 mm I: 1655 mm
NBI*1		Available



*1 NBI stands for Narrow Band Imaging. For more details, refer to the instruction manual of the CV-180.

Model	CF-H180AL	CF-H180AI
Optical system	Field of view	170°
	Direction of view	Forward viewing
	Depth of field	2 – 100 mm
Insertion tube	Distal end outer diameter	ø 13.9 mm
	Distal end enlarged	1. Air/water nozzle 2. Light guide lens 3. Objective lens 4. Instrument channel outlet 5. Auxiliary water channel
	Insertion tube outer diameter	ø 12.8 mm
	Working length	L: 1680 mm I: 1330 mm
	Range of the flexibility adjustment	The rigidity in the most-rigid condition is about twice that in the most-flexible condition.
Instrument channel	Channel inner diameter	ø 3.7 mm
	Minimum visible distance	3 mm from the distal end
	Direction from which endo-therapy accessories enter and exit the endoscopic image	
Air flow rate	25 cm ³ /s	Note: Standard when CLV-180 (high air pressure) is used.
Bending section	Angulation range	UP 180°, DOWN 180°, RIGHT 160°, LEFT 160°
Total length		L: 2005 mm I: 1655 mm
NBI*1		Available

*1 NBI stands for Narrow Band Imaging. For more details, refer to the instruction manual of the CV-180.

Model	PCF-Q180AL	PCF-Q180AI
Optical system	Field of view	140°
	Direction of view	Forward viewing
	Depth of field	3 – 100 mm
Insertion tube	Distal end outer diameter	ø 11.3 mm
	Distal end enlarged	1. Air/water nozzle 2. Light guide lens 3. Objective lens 4. Instrument channel 5. Auxiliary water channel
	Insertion tube outer diameter	ø 11.5 mm
	Working length	L: 1680 mm I: 1330 mm
	Range of the flexibility adjustment	The rigidity in the most-rigid condition is about twice that in the most-flexible condition.
Instrument channel	Channel inner diameter	ø 3.2 mm
	Minimum visible distance	5 mm from the distal end
	Direction from which endo-therapy accessories enter and exit the endoscopic image	
Air flow rate	25 cm ³ /s Note: Standard when CLV-180 (high air pressure) is used.	
Bending section	Angulation range	UP 180°, DOWN 180°, RIGHT 160°, LEFT 160°
Total length	L: 2005 mm I: 1655 mm	
NBI*1	Available	

*1 NBI stands for Narrow Band Imaging. For more details, refer to the instruction manual of the CV-180.

Medical Device Directive		<p>This device complies with the requirements of Directive 93/42/EEC concerning medical devices. Classification: Class II a</p>
EMC	<p>Applied standard; IEC 60601-1-2: 2001</p>	<p>This instrument complies with the standards listed in the left column.</p>
		<p>CISPR 11 of emission:</p>
		<p>Group 1, Class B</p>
		<p>This instrument complies with the EMC standard for medical electrical equipment; edition 2 (IEC 60601-1-2: 2001). However, when connecting to an instrument that complies with the EMC standard for medical electrical equipment; edition 1 (IEC 60601-1-2: 1993), the whole system complies with edition 1.</p>
Year of manufacture	<p>2512345</p> 	<p>The last digit of the year of manufacture is the second digit of the serial number.</p>
Degree of protection against electric shock		<p>TYPE BF applied part</p>

2.4 Attaching the chain for water-resistant cap (MAJ-1119)

CAUTION

- Do not lift the endoscope by the chain for water-resistant cap. Otherwise, operator and/or patient injury can result, or the endoscope and/or water-resistant cap may be damaged when the fitting comes off the S-cord connector mount or the chain connector of the GIF-N180.
- Only connect the fitting to the S-cord connector mount or the chain connector of the GIF-N180. Connecting the fitting to the suction connector may impair the connection of the suction tube to the suction connector. It may also cause the suction tube to become disconnected from the endoscope and allow patient debris to spray.
- The chain for water-resistant cap and water-resistant cap itself cannot be ultrasonically cleaned; doing so could damage them. The water-resistant cap with the chain can only be ultrasonically cleaned if connected to endoscopes that are being cleaned in an endoscope reprocessor (such as OER) with an ultrasonic cleaning phase.
- When attaching the water-resistant cap to the electrical connector, do not pinch the chain for water-resistant cap between the electrical connector of the endoscope and the water-resistant cap. Otherwise, equipment damage may result.
- The chain for water-resistant cap and water-resistant cap cannot be ETO gas sterilized; doing so may damage them. If the water-resistant cap is connected to the endoscope by the chain, be sure to remove the chain and the water-resistant cap from the endoscope before ETO gas sterilization.

- The chain for water-resistant cap and water-resistant cap cannot be steam sterilized (autoclaved); doing so can damage them severely.

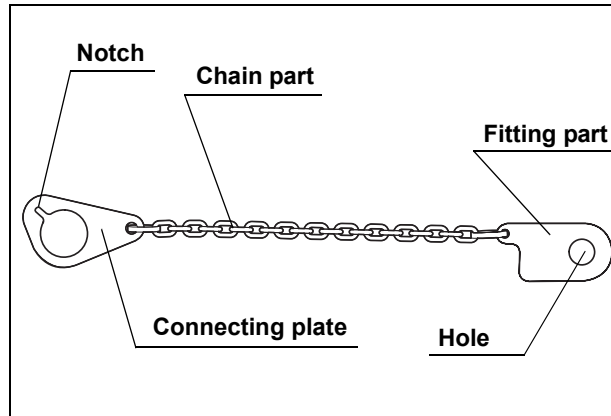

Figure 2.1

NOTE

To ensure that you do not forget to attach the water-resistant cap, it is recommended that you connect it to the endoscope's S-cord connector mount or the chain connector of the GIF-N180 using the chain for water-resistant cap.

1. Confirm that the chain for water-resistant cap is free from cracks, flaws, wear, deformation or other damages (see Figure 2.1).
2. Align the notch on the connecting plate with the pin on the venting connector of the water-resistant cap (MH-553, see Figure 2.2).
3. Place the connecting plate over the venting connector (see Figure 2.2).
4. Confirm that the connecting plate is securely attached to the foot of the venting connector and can be smoothly rotated.
5. Place the hole on the fitting over the endoscope's S-cord connector mount or the chain connector of the GIF-N180 (see Figure 2.3).

6. Confirm that the fitting is securely attached to the foot of the S-cord connector mount or the chain connector of the GIF-N180 and can be smoothly rotated.

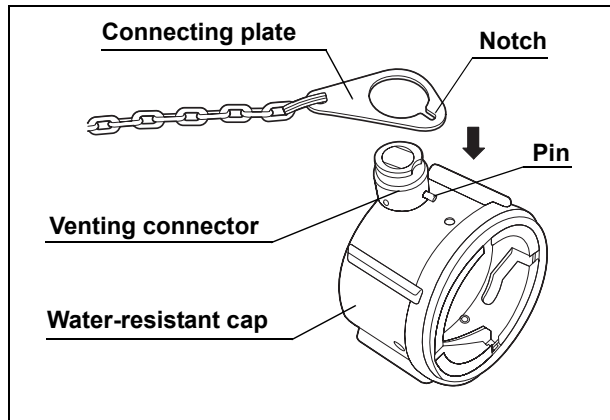

Figure 2.2

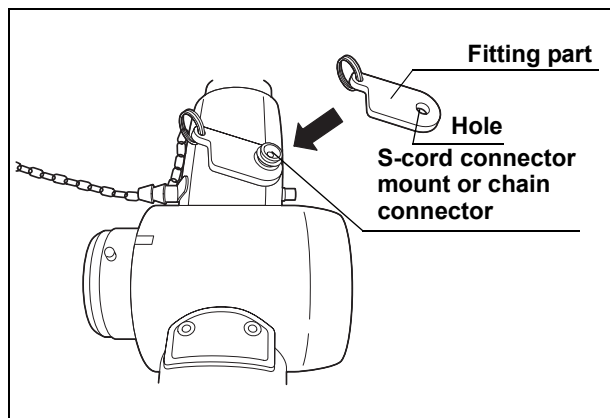

Figure 2.3

NOTE

The instructions on the remaining pages of this manual are given under the assumption that the chain for the water-resistant cap is detached from the endoscope.

Chapter 3 Preparation and Inspection

Before each case, prepare and inspect this instrument as instructed below. Inspect other equipment to be used with this instrument as instructed in their respective instruction manuals. If any irregularities are suspected after inspection, follow the instructions as described in Chapter 5, “Troubleshooting”. If this instrument malfunctions, do not use it. Return it to Olympus for repair as described in Section 5.3, “Returning the endoscope for repair” on page 86.

WARNING

- Using an endoscope that is not functioning properly may compromise patient or operator safety and may result in more severe equipment damage.
- This instrument was not cleaned, disinfected or sterilized before shipment. Before using this instrument for the first time, reprocess it according to the instructions as described in the endoscope’s companion manual, the “REPROCESSING MANUAL” whose cover lists the model of your endoscope.

3.1 Preparation of the equipment

Prepare the equipment shown in Figure 3.1 (for compatibility, see the “System chart” in the Appendix) and personal protective equipment, such as eye wear, face mask, moisture-resistant clothing and chemical-resistant gloves, before each use. Refer to the respective instruction manuals for each piece of equipment.

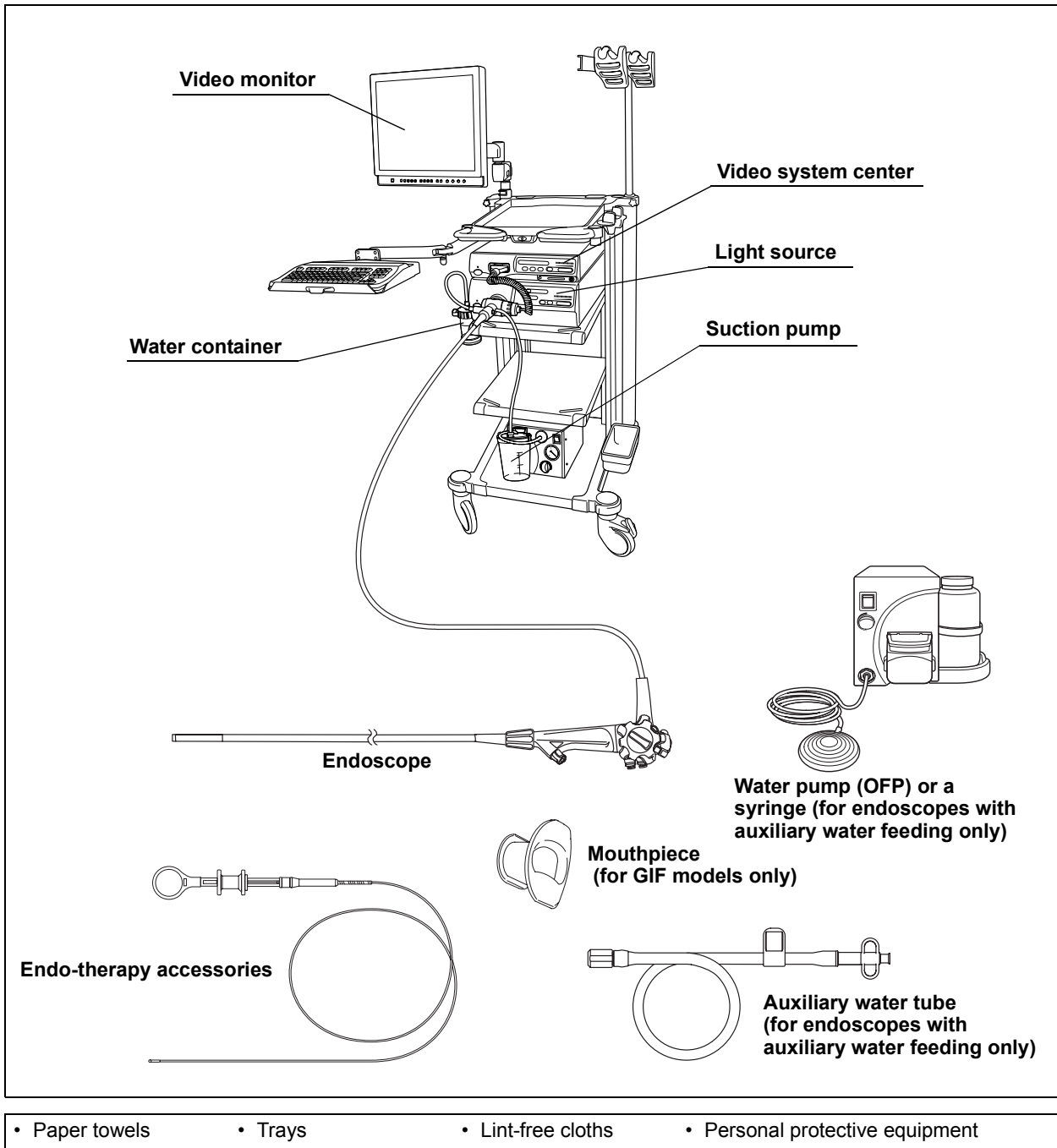

Figure 3.1

3.2 Inspection of the endoscope

Clean and disinfect or sterilize the endoscope as described in the “REPROCESSING MANUAL” whose cover lists the model of your endoscope. Then remove the water-resistant cap from the endoscope connector.

Inspection of the endoscope

1. Inspect the control section and the endoscope connector for excessive scratching, deformation, loose parts or other irregularities.
2. Inspect the boot and the insertion tube near the boot for bends, twists or other irregularities.
3. Inspect the external surface of the entire insertion tube including the bending section and the distal end for dents, bulges, swelling, scratching, holes, sagging, transformation, bends, adhesion of foreign bodies, dropout of parts, any protruding objects or other irregularities.
4. Holding the insertion tube gently with one hand, carefully run your fingertips over the entire length of the insertion tube in both directions (see Figure 3.2). Confirm that no objects or metallic wire protrude from the insertion tube. Also confirm that the insertion tube is not abnormally rigid.

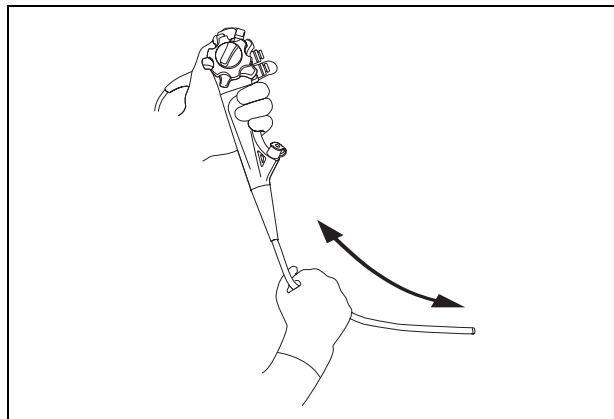

Figure 3.2

5. Using both hands, bend the insertion tube of the endoscope into a semicircle. Then, moving your hands as shown by the arrows in Figure 3.3, confirm that the entire insertion tube can be smoothly bent to form a semicircle and that the insertion tube is pliable. When inspecting endoscopes with flexibility adjustment, perform the test with the insertion tube at both its most-flexible and most-rigid settings (for endoscopes with flexibility adjustment only).

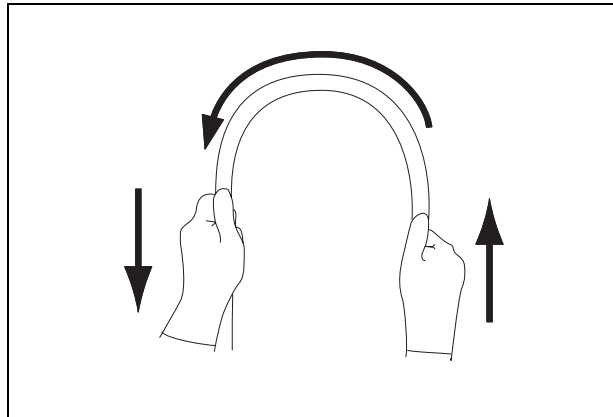

Figure 3.3

6. Gently hold the midpoint of the bending section and a point 20 cm from the distal end. Push and pull gently to confirm that the junction between the bending section and the insertion tube is not loose.
7. Inspect the objective lens and light guide lens at the distal end of the endoscope's insertion tube for scratching, cracks, stains or other irregularities.
8. Inspect the air/water nozzle at the distal end of the endoscope's insertion tube for abnormal swelling, bulges, dents or other irregularities.

***Inspection of the flexibility adjustment mechanism
(for endoscopes with flexibility adjustment only)***

1. Confirm that the marks (“●”, “1”, “2”, “3”) on the flexibility adjustment ring and the “■” mark at the bottom of the grip section are clearly visible (see Figure 3.4).

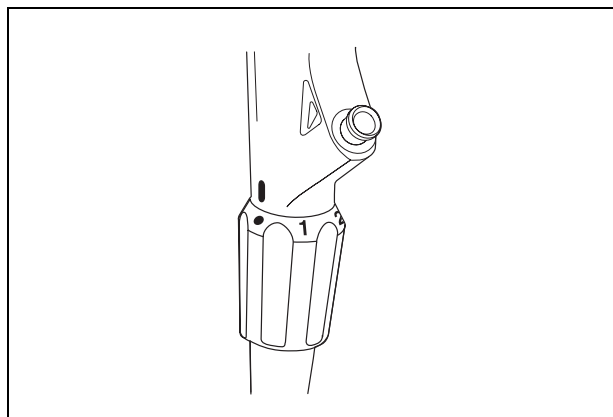

Figure 3.4

WARNING

Do not use the endoscope if the markings are not clearly visible. If the operator is uncertain of the flexibility of the endoscope, insertion and manipulation of the endoscope may cause patient pain and/or injury.

2. Confirm that the flexibility adjustment ring can be turned smoothly when the insertion tube is straight.

NOTE

If the insertion tube is coiled into a too small diameter, the flexibility adjustment ring may not operate smoothly. This does not indicate a malfunction.

3. Set the insertion tube to the most-flexible and most-rigid conditions, respectively. In each case, hold the marks of 30 and 50 cm of the insertion tube with two hands, and bend it gently as shown in Figure 3.5. Confirm that the actual flexibility changes according to the flexibility adjustment setting.

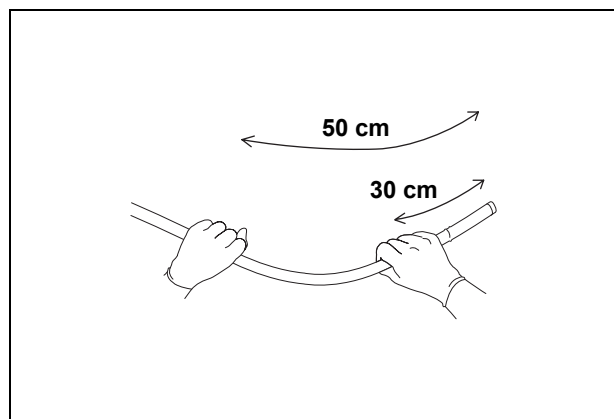

Figure 3.5

Inspection of the bending mechanisms

Perform the following inspections while the bending section is straight.

WARNING

- If the movement of the UP/DOWN angulation lock, RIGHT/LEFT angulation lock and their angulation control knobs are loose and/or not smooth, or the bending section does not angulate smoothly, the bending mechanism may be abnormal. In this case, do not use the endoscope because it may be impossible to straighten the bending section during an examination (except GIF-N180).
- If the movement of the UP/DOWN angulation lock and its angulation control knob are loose and/or not smooth, or the bending section does not angulate smoothly, the bending mechanism may be abnormal. In this case, do not use the endoscope because it may be impossible to straighten the bending section during an examination (for GIF-N180 only).

○ Inspection for smooth operation

1. Confirm that both the UP/DOWN and RIGHT/LEFT angulation locks move all the way in the “F▶” direction (the GIF-N180 has only the UP/DOWN angulation lock).
2. Turn the UP/DOWN and RIGHT/LEFT angulation control knobs slowly in each direction until they stop, and return them to their respective neutral positions (the GIF-N180 has only the UP/DOWN angulation control knob). Confirm that the bending section angulates smoothly and correctly, that maximum angulation can be achieved, and that the bending section returns to its neutral position.

3. When the UP/DOWN and RIGHT/LEFT angulation control knobs are turned to their respective neutral positions as shown in Figure 3.6, confirm that the bending section returns smoothly to an approximately straight condition (except GIF-N180).

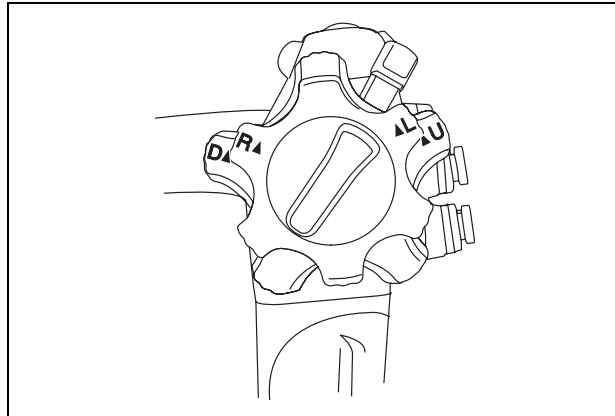

Figure 3.6

4. When the UP/DOWN angulation control knob is turned to its neutral position as shown in Figure 3.7, confirm that the bending section returns smoothly to an approximately straight condition (for GIF-N180 only).

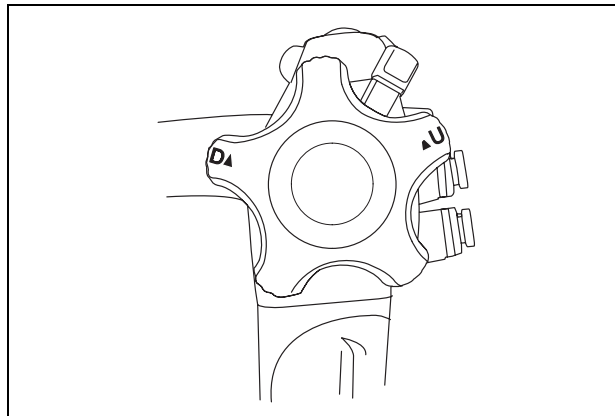

Figure 3.7

○ **Inspection of the UP/DOWN angulation mechanism**

1. Move the UP/DOWN angulation lock all the way in the opposite direction of the “F▶” mark. Then turn the UP/DOWN angulation control knob in the “▲U” or the “D▲” direction until it stops.
2. Confirm that the angle of the bending section is roughly stabilized when the UP/DOWN angulation control knob is released.
3. Confirm that the bending section straightens out when the UP/DOWN angulation lock is moved all the way in the “F▶” direction and the UP/DOWN angulation control knob is released.

○ **Inspection of the RIGHT/LEFT angulation mechanism (except GIF-N180)**

1. Turn the RIGHT/LEFT angulation lock all the way in the opposite direction of the “F▶” mark. Then turn the RIGHT/LEFT angulation control knob in the “R▲” or the “▲L” direction until it stops.
2. Confirm that the angle of the bending section is roughly stabilized when the RIGHT/LEFT angulation control knob is released.
3. Confirm that the bending section straightens out when the RIGHT/LEFT angulation lock is turned in the “F▶” direction and the RIGHT/LEFT angulation control knob is released.

3.3 Preparation and inspection of accessories

Clean and disinfect or sterilize the air/water valve, suction valve, biopsy valve and auxiliary water tube as described in the endoscope's companion reprocessing manual, the "REPROCESSING MANUAL" whose cover lists the model of your endoscope.

Inspection of the air/water and suction valves

WARNING

Confirm that the top hole of the air/water valve is not blocked (see Figure 3.8). If the hole is blocked, air is fed continuously and patient pain, bleeding and/or perforation can result.

1. Confirm that the holes of the valves are not blocked (see Figures 3.8 and 3.9).
2. Confirm that the valves are not deformed or cracked (see Figures 3.8 and 3.9).
3. Check for excessive scratching or tears in the air/water valve's seals (see Figure 3.8).

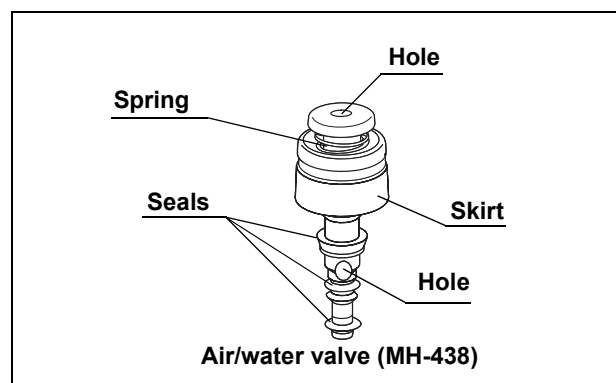

Figure 3.8

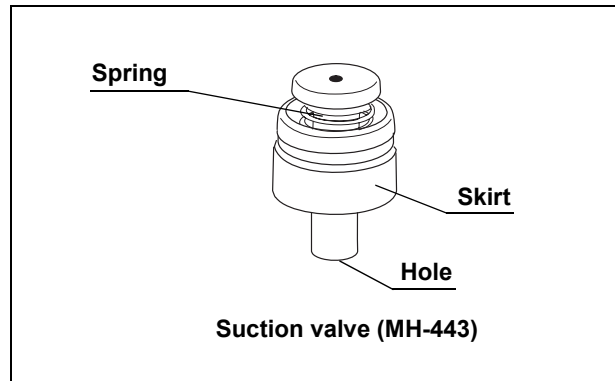

Figure 3.9

NOTE

The air/water and suction valves are consumable items. If the inspection of the air/water or suction valve reveals any irregularities, use new valves.

Inspection of the biopsy valve

WARNING

The biopsy valve is a consumable item that should be inspected before each use. Replace it with a new one if irregularities are observed during the following inspection. An irregular, abnormal or damaged valve can reduce the efficacy of the endoscope's suction system, and may leak or spray patient debris or fluids, posing an infection-control risk.

1. Confirm that the slit and hole on the biopsy valve have no splits, cracks, deformation, discoloration or other damage (see Figure 3.10).

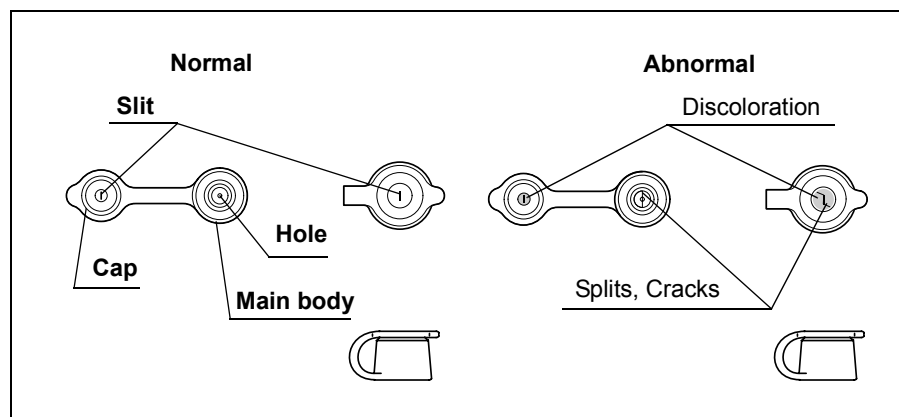

Figure 3.10

2. Attach the cap to the main body (see Figure 3.11).

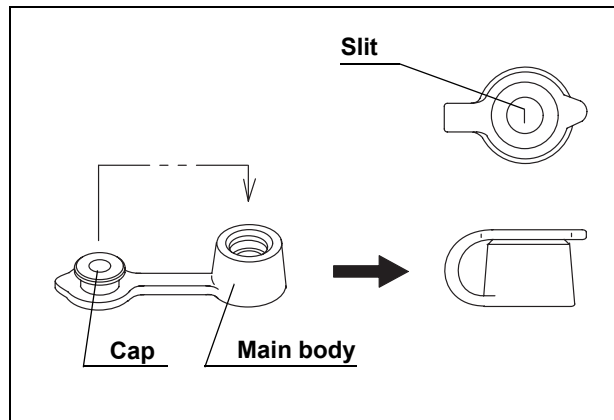

Figure 3.11

Inspection of the auxiliary water inlet cap (for endoscopes with auxiliary water feeding only)

1. Confirm that the auxiliary water inlet cap attached to the endoscope connector has no dents, cracks or other irregularities (see Figure 3.12).
2. If irregularities are observed, replace it with a new one as described in “Attaching the auxiliary water inlet cap (for endoscopes with auxiliary water feeding only)” on page 49.

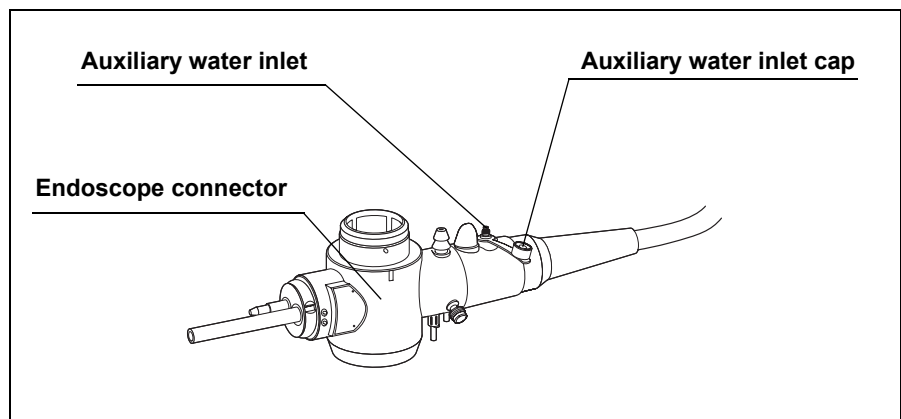

Figure 3.12

Inspection of the auxiliary water tube (for endoscopes with auxiliary water feeding only)

Inspect the auxiliary water tube for cracks, scratches, flaws and other damage (see Figure 3.13).

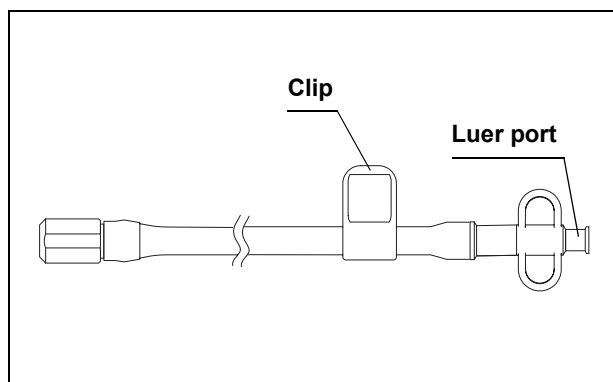

Figure 3.13

Inspection of the mouthpiece (for GIF models only)

CAUTION

Do not use a mouthpiece that is damaged, deformed or reveals other irregularities. Doing so may cause patient injury and/or equipment damage.

NOTE

Placing the mouthpiece in the patient's mouth before the procedure prevents the patient from biting and/or damaging the endoscope's insertion tube.

1. Confirm that the mouthpiece is free from cracks, deformation or discoloration (see Figure 3.14).
2. Using your fingers, check for excessive scratching or other irregularities on all surfaces of the mouthpiece (see Figure 3.14).

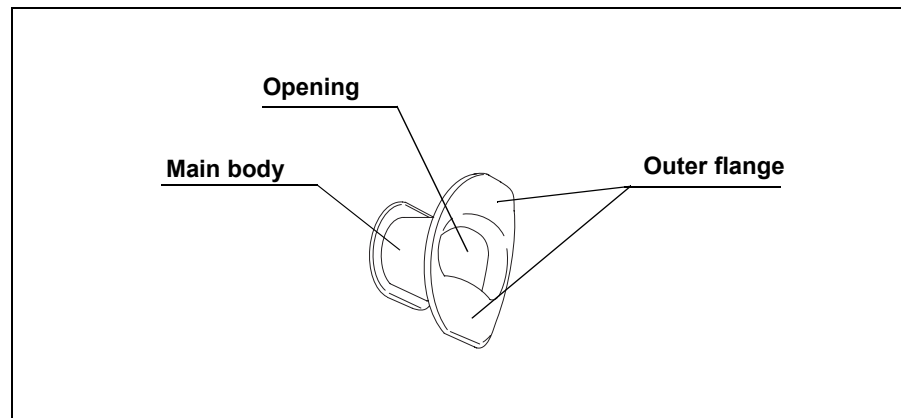

Figure 3.14

3.4 Attaching accessories to the endoscope

CAUTION

The air/water valve and the suction valve do not require lubrication. Lubricants can cause swelling of the valves' seals, which will impair valve function.

Attaching the suction valve

1. Align the two metal ridges on the underside of the suction valve with the two holes in the suction cylinder.
2. Attach the suction valve to the suction cylinder of the endoscope (see Figures 3.15 and 3.16). Confirm that the valve fits properly without any bulging of the skirt. Also confirm that the valve cannot be rotated.

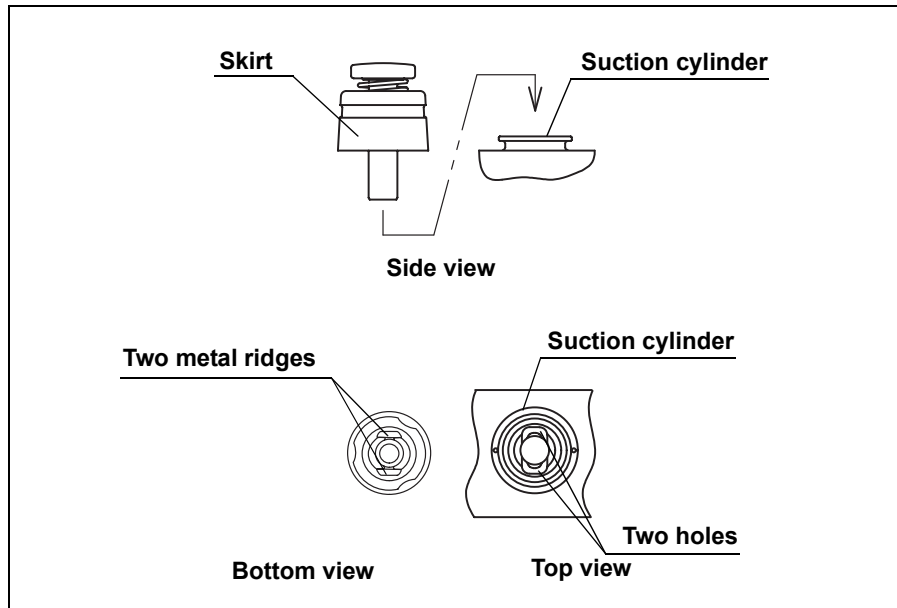

Figure 3.15

NOTE

The suction valve will make a whistling noise when it is dry; this does not indicate a malfunction.

Attaching the air/water valve

1. Attach the air/water valve to the air/water cylinder of the endoscope (see Figure 3.16).
2. Confirm that the valve fits properly without any bulging of the skirt.

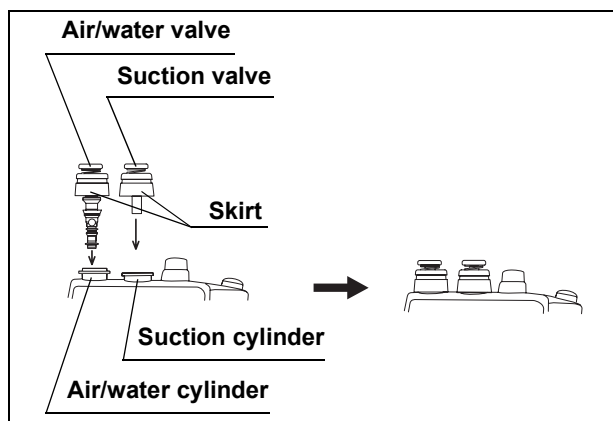

Figure 3.16

NOTE

The air/water valve may stick at first, but it should operate smoothly after it is depressed a few times.

Attaching the biopsy valve

WARNING

If a biopsy valve is not properly connected to the instrument channel port, it can reduce the efficacy of the endoscope's suction system and may cause patient debris to leak or spray from the endoscope.

Attach the biopsy valve to the instrument channel port of the endoscope (see Figure 3.17). Confirm that the biopsy valve fits properly.

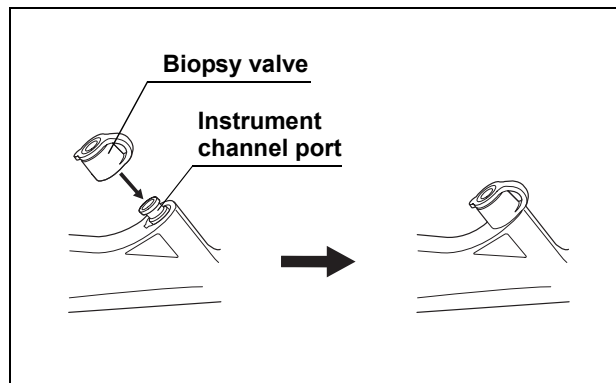

Figure 3.17

Attaching the auxiliary water inlet cap (for endoscopes with auxiliary water feeding only)

If the auxiliary water inlet cap is not attached, attach the fitting ring to the auxiliary water inlet on the endoscope connector (see Figure 3.18).

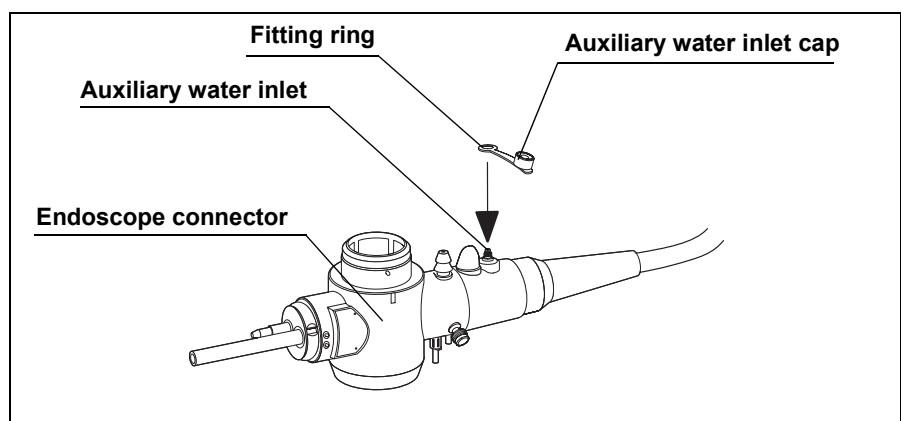

Figure 3.18

3.5 Inspection and connection of ancillary equipment

Inspection of ancillary equipment

CAUTION

- Attach the water container to the specified receptacle on the trolley or the light source. If the water container is attached anywhere else, water may drip from the water container's water supply tube, and equipment malfunction can result.
- Take care not to spill water from the water container's connection adapter when detaching the connection adapter from the endoscope. Spilled water could splash on the equipment, and it may cause equipment malfunction.

Prepare and inspect the light source, video system center, video monitor, water container, suction pump and endo-therapy accessories as described in their respective instruction manuals.

Connection of the endoscope and ancillary equipment

WARNING

Firmly connect the suction tube from the suction pump to the suction connector on the endoscope connector. If the suction tube is not attached properly, debris may drip from the tube and can present an infection-control risk, damage and/or reduce suction capability.

CAUTION

The CV-100 is not compatible with the GIF-N180. If the GIF-N180 is used with the CV-100, the endoscopic image may not appear on the video monitor.

The GIF-H180 and CF-H180AL/I can only be connected to the CV-180.

1. If any ancillary equipment is ON, turn it OFF.
2. Insert the endoscope connector completely into the scope socket (output socket when using the CLV-U40) of the light source.
3. Connect the water container's connection adapter to the air supply connector and water supply connector (see Figure 3.19).
4. Confirm that the water container's connection adapter fits properly and that it cannot be rotated.

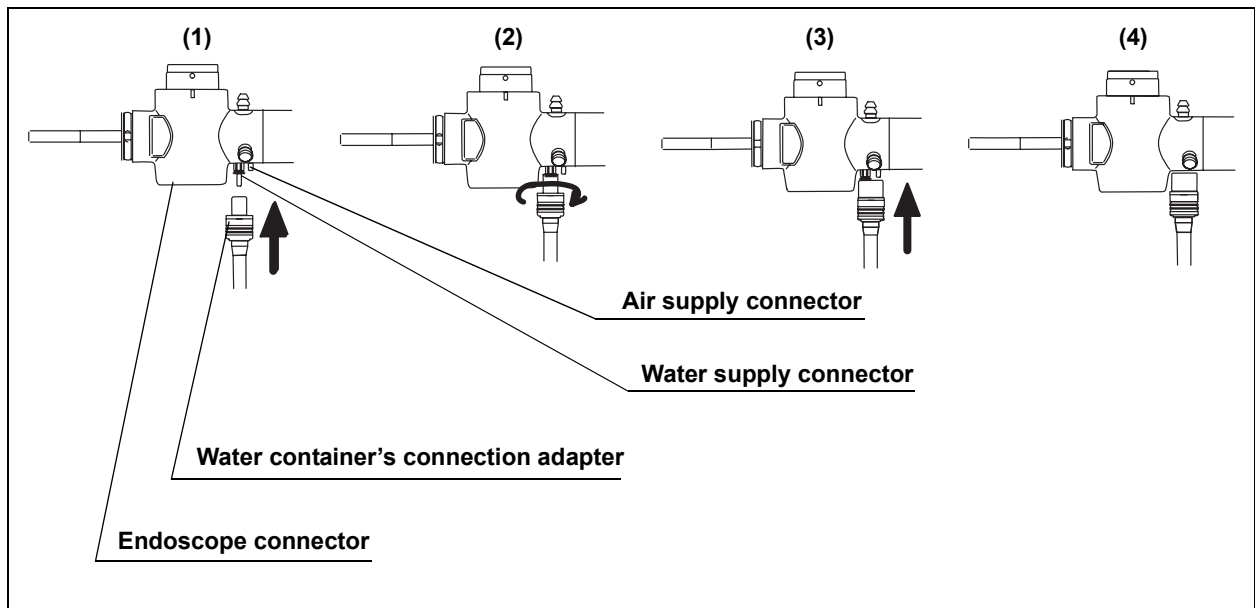

Figure 3.19

5. Align the mark on the videoscope cable EXERA II, the videoscope cable EXERA or the videoscope cable 100 with mark 1 on the endoscope connector and push it in until it stops (see Figure 3.20).

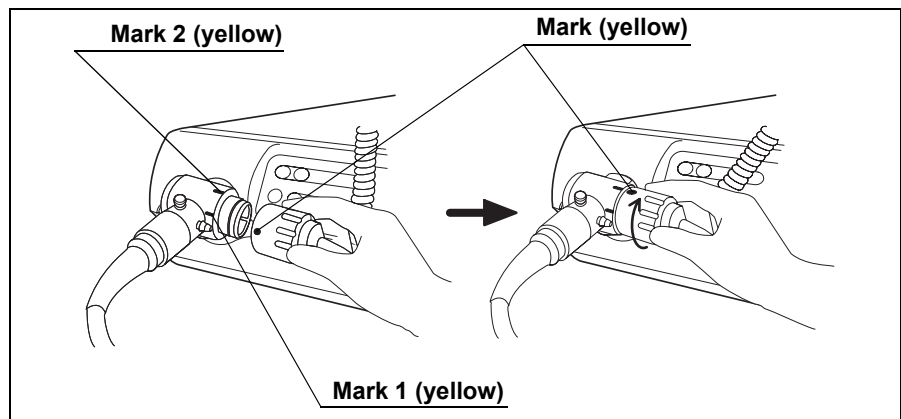

Figure 3.20

6. Turn the connector of the videoscope cable clockwise until it stops (see Figure 3.20).
7. Confirm that the mark on the videoscope cable is aligned with mark 2 on the endoscope connector.

8. Connect the suction tube from the suction pump to the suction connector on the endoscope connector (see Figure 3.21).

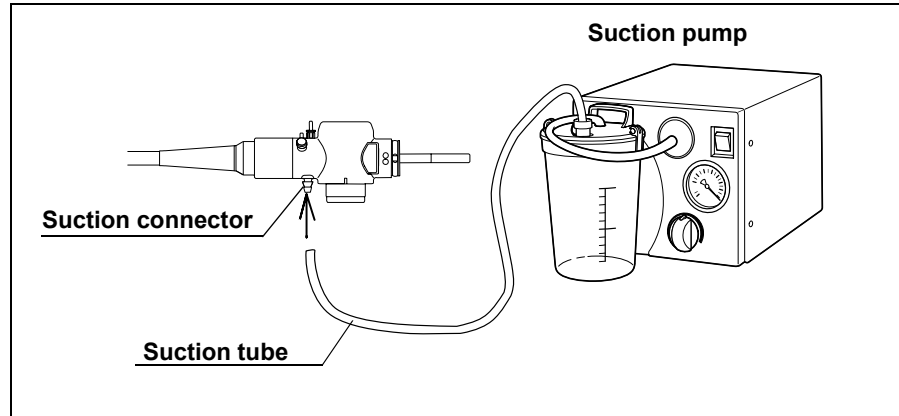

Figure 3.21

9. Open the auxiliary water inlet cap (for endoscopes with auxiliary water feeding only, see Figure 3.22).
10. Connect the auxiliary water tube to the auxiliary water inlet on the endoscope connector and turn it clockwise until it stops (for endoscopes with auxiliary water feeding only, see Figure 3.22).

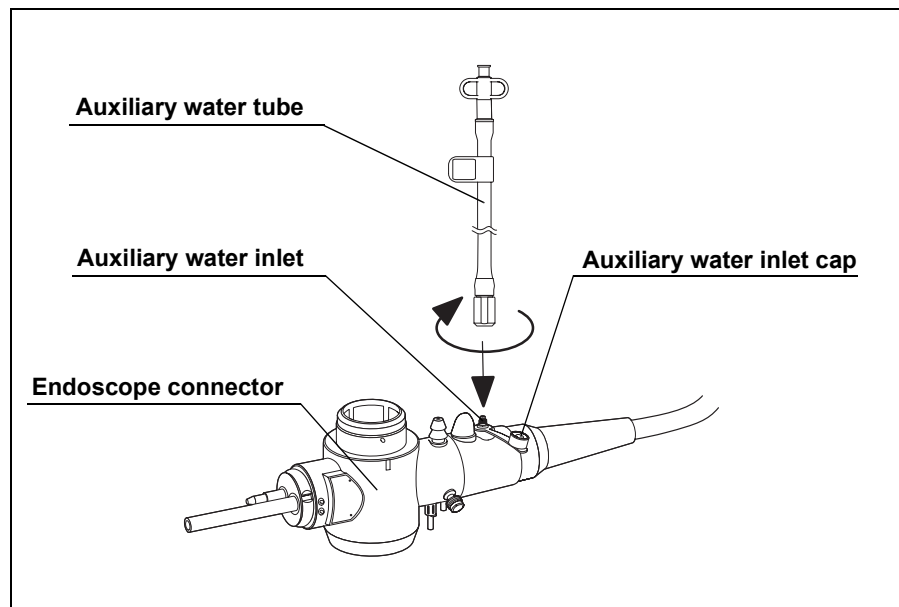

Figure 3.22

3.6 Inspection of the endoscopic system

Inspection of the endoscopic image

WARNING

Do not stare directly at the distal end of the endoscope while the examination light is ON. Otherwise, eye injury may result.

1. Turn the video system center, light source, video monitor ON and inspect the endoscopic image as described in their respective instruction manuals.
2. Confirm that light is output from the endoscope's distal end.
3. While observing the palm of your hand, confirm that the endoscopic image is free from noise, blur, fog or other irregularities.
4. Angulate the endoscope and confirm that the endoscopic image does not momentarily disappear or displays any other irregularities.

NOTE

If the object cannot be seen clearly, wipe the objective lens using a clean lint-free cloth moistened with 70% ethyl or isopropyl alcohol.

Inspection of remote switch

WARNING

All remote control switches should be checked to work normally even when they are not expected for use. The endoscopic image may freeze or other irregularities may occur during examination and may cause patient injury, bleeding and/or perforation.

Depress every remote control switch and confirm that the specified functions work normally.

Inspection of the air feeding function

1. Set the airflow regulator on the light source to "High", as described in the light source's instruction manual.
2. Immerse the distal end of the insertion tube in sterile water to a depth of 10 cm and confirm that no air bubbles are emitted when the air/water valve is not operated.
3. Cover the hole in the air/water valve with your finger and confirm that air bubbles are continuously emitted from the air/water nozzle.

4. Uncover the hole in the air/water valve and confirm that no air bubbles are emitted from the air/water nozzle.

WARNING

If a stream of air bubbles is emitted from the air/water nozzle even though the air/water valve is not being operated and the distal end of the insertion tube is 10 cm or more below the surface of the sterile water, there may be an irregularity in the air feeding function. If the endoscope is used while air is continuously fed, over-insufflation and patient injury may result. If air bubbles are emitted from the air/water nozzle, remove and reattach the air/water valve correctly, or replace it with a new one. If this fails to stop air bubbles from being emitted, do not use the endoscope, as there may be a malfunction. Contact Olympus.

NOTE

When the distal end of the insertion tube is immersed less than 10 cm below the surface of the sterile water, a small amount of air bubbles may be emitted from the air/water nozzle even when the air/water valve is not operated. This does not indicate a malfunction.

Inspection of the objective lens cleaning function

WARNING

Use sterile water only. Non-sterile water may cause patient cross-contamination and/or infection.

NOTE

- When the air/water valve is depressed for the first time, it may take a few seconds before water is emitted.
 - If the air/water valve returns to its original position slowly after water feeding, remove the air/water valve and moisten the seals with sterile water.
 - During the inspection, place the distal end of the endoscope in a beaker or other container so that the floor does not get wet.
1. Keep the air/water valve's hole covered with your finger and depress the valve. Observe the endoscopic image and confirm that water flows on the entire objective lens.
 2. Release the air/water valve. Observe the endoscopic image and confirm that the emission of water stops and that the valve returns smoothly to its original position.

3. While observing the endoscopic image, feed air after feeding water by covering the hole in the air/water valve with your finger. Confirm that the emitted air removes the remaining water from the objective lens and clears the endoscopic image.

Inspection of the suction function

WARNING

- If the suction valve does not operate smoothly, detach it and reattach it, or replace it with a new one. If the endoscope is used while the suction valve is not working properly, it may be impossible to stop suction, which could cause patient injury. If the reattached or replaced suction valve fails to operate smoothly, the endoscope may be malfunctioning; stop using it and contact Olympus.
 - If the biopsy valve leaks, replace it with a new one. A leaking biopsy valve can reduce the efficacy of the endoscope's suction system, and may leak or spray patient debris or fluids, posing an infection-control risk.
1. Place the container of sterile water and the endoscope on the same height. For the inspection, adjust the suction pressure to the same level as it will be during the procedure.
 2. Immerse the distal end of the insertion tube in sterile water with the endoscope's instrument channel port at the same height as the water level in the water container. Press the suction valve and confirm that water is continuously aspirated into the suction bottle of the suction pump.
 3. Release the suction valve. Confirm that suction stops and the valve returns to its original position.
 4. Depress the suction valve and aspirate water for one second. Then, release the suction valve for one second. Repeat this several times and confirm that no water leaks from the biopsy valve.
 5. Remove the distal end of the endoscope from the water. Depress the suction valve and aspirate air for a few seconds to remove any water from the instrument channel.

Inspection of the instrument channel

WARNING

Keep your eyes away from the distal end when inserting endo-therapy accessories. Extending the endo-therapy accessory from the distal end could cause eye injury.

1. Insert the endo-therapy accessory through the biopsy valve. Confirm that the endo-therapy accessory extends smoothly from the distal end. Also make sure that no foreign objects come out of the distal end.
2. Confirm that the endo-therapy accessory is withdrawn smoothly from the biopsy valve.

Inspection of the auxiliary water feeding function (for endoscopes with auxiliary water feeding only)

WARNING

- Use sterile water only. Non-sterile water may cause patient cross-contamination and/or infection.
 - Note that the luer port on the MAJ-855 includes a one-way valve to prevent backflow – do not use the MAJ-855 without the luer port in place, otherwise backflow of contaminated material may occur and equipment damage or patient injury may result.
1. Attach a syringe containing sterile water or the water tube from a water pump to the luer port of the auxiliary water tube (see Figure 3.23). Feed water and confirm that water is emitted from the auxiliary water channel at the distal end of the insertion tube.
 2. Make sure that no water leaks from the connection between the connecting end of the auxiliary water tube and the auxiliary water inlet.
 3. Make sure that no water leaks from the connection between the luer port of the auxiliary water tube and the syringe or water tube.
 4. Disconnect the water tube from the water pump or the syringe from the luer port of the auxiliary water tube. Make sure that no water leaks from the luer port of the auxiliary water tube and/or the distal end of the insertion tube.

CAUTION

If the auxiliary water channel is used for feeding water, never disconnect the auxiliary water tube during an examination; leave it attached until the endoscope is precleaned. If the auxiliary water tube is detached before precleaning, water remaining in the auxiliary water channel may be spilled on the surrounding equipment. This could cause damage to and/or malfunction of the equipment.

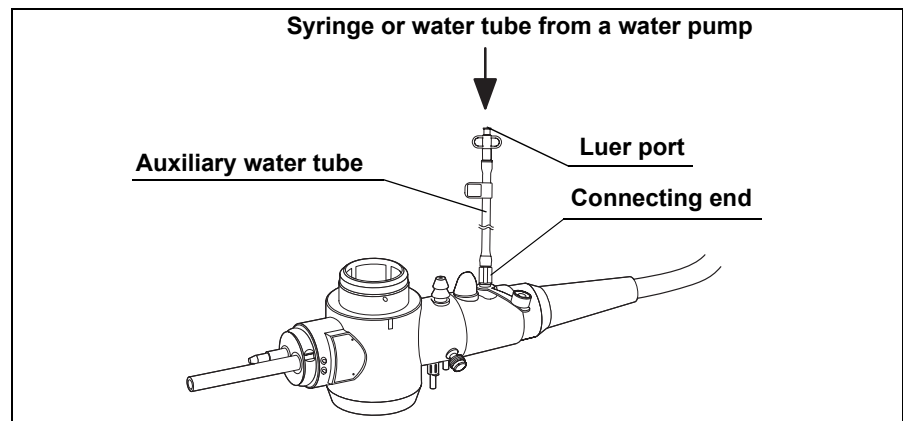

Figure 3.23

Chapter 4 Operation

The operator of this instrument must be a physician or medical personnel under the supervision of a physician and must have received sufficient training in clinical endoscopic technique. This manual, therefore, does not explain or discuss clinical endoscopic procedures. It only describes basic operation and precautions related to the operation of this instrument.

WARNING

- Wear personal protective equipment to guard against dangerous chemicals and potentially infectious material during the procedure. Wear appropriate personal protective equipment, such as eye wear, face mask, moisture-resistant clothing and chemical-resistant gloves that fit properly and are long enough so that your skin is not exposed.
- The temperature of the distal end of the endoscope may exceed 41°C (106°F) and reach 50°C (122°F) due to intense endoscopic illumination. Surface temperatures over 41°C (106°F) may cause mucosal burns. Always use the minimum level of illumination, minimum time and suitable distance necessary for adequate viewing. Whenever possible, avoid close stationary viewing and do not leave the distal end of the endoscope close to the mucous membrane for a long time.
- Whenever possible, do not leave the endoscope illuminated before and/or after an examination. Continued illumination will cause the distal end of the endoscope to become hot and could cause operator and/or patient burns.
- Turn the video system center ON to operate the light source's automatic brightness function. When the video system center is OFF, it cannot operate the light source's automatic brightness function, and the light intensity is set to the maximum level. In this case, the distal end of the endoscope can become hot and could cause operator and/or patient burns (when using a light source other than CLV-180).

- Never insert or withdraw the endoscope under any of the following conditions. Otherwise, patient injury, bleeding and/or perforation can result.
 - While the endo-therapy accessory extends from the distal end of the endoscope.
 - While the bending section is locked in position.
 - Insertion or withdrawal with excessive force, or forcible insert or withdrawal.
 - While the image is magnified (when using the image magnification function of the video system center CV-180).
- Transnasal insertion is accompanied by the risk of inflammation of the nasal cavity. If this happens, the nasal passage will be constricted, making it more difficult to withdraw the endoscope. In this case, do not use force to withdraw the endoscope because patient injury such as bleeding or perforation may result.
- Transnasal insertion is accompanied by the risk of bleeding in the nasal cavity. Be sure to be prepared to deal with any bleeding. When withdrawing the endoscope, observe the inside of the nasal cavity to ensure that there is no bleeding. Even when the endoscope has been withdrawn without bleeding, do not allow the patient to blow his or her nose strongly because this could cause it to start bleeding.
- Before transnasal insertion, apply the appropriate pretreatment and lubrication to the patient to enlarge the nasal cavity. Otherwise, operator and/or patient injury can result or the endoscope could become lodged and be difficult to withdraw. When applying a pretreatment agent through a tube, insert the tube into the same path as the path planned for the endoscope insertion. Otherwise, the treatment will have no effect. The effects of the pretreatment agent and lubricant will decrease the longer the procedure lasts. Apply the pretreatment agent or lubricant as required during the procedure – for example, when withdrawal seems to be difficult.
- If any of the following phenomena occur during an examination, immediately stop the examination and withdraw the endoscope from the patient as described in Section 5.2, “Withdrawal of the endoscope with an abnormality” on page 83.

- If any abnormality is suspected with the functionality of the endoscope.
- If the endoscopic image on the video monitor disappears or freezes unexpectedly.
- If the angulation control knob is locked.
- If the angulation control mechanism is not functioning properly.
- If the zoom malfunctions (when using the image magnification function of the video system center CV-180).
- If the flexibility adjustment ring becomes jammed (for endoscopes with flexibility adjustment only).

Continued use of the endoscope under these conditions could result in patient injury, bleeding and/or perforation.

- If an abnormal endoscopic image or function is observed, but quickly corrects itself, the endoscope may have malfunctioned. Continuous use of such an endoscope may cause the abnormality to occur again, at which time it may not return to the normal condition. In this case, stop the examination immediately and slowly withdraw the endoscope while viewing the endoscopic image. Otherwise, patient injury, bleeding and/or perforation can result.
- Never perform flexibility adjustment while the endo-therapy accessory extends from the distal end of the endoscope. Patient injury, bleeding and/or perforation can result (for endoscopes with flexibility adjustment only).
- Regardless of the flexibility of the endoscope's insertion tube, it can cause patient injury, bleeding and/or perforation if it is forcibly inserted, withdrawn and/or twisted with excessive force. It is generally believed that an endoscope with a more-rigid insertion tube is easier to manipulate in the intestines if used properly. However, it should be noted that such an endoscope, if used improperly, is more likely to cause patient pain, injury, bleeding and/or perforation than an endoscope with a more flexible insertion tube (for endoscopes with flexibility adjustment only).

- The flexibility of the insertion tube of the CF-Q180AL/I and CF-H180AL/I can be adjusted to less than, equal to or more than that of the CF-Q160L/I. The range of the flexibility adjustment of the CF-Q180AL/I and CF-H180AL/I are equal to that of the CF-Q160AL/I.

The flexibility of the insertion tube of the PCF-Q180AL/I can be adjusted to less than, equal to or more than that of the PCF-140L/I. The range of the flexibility adjustment of the PCF-Q180AL/I is equal to that of the PCF-160AL/I.

The insertion tube of the endoscope should be adjusted to the appropriate flexibility for each case. Always confirm the flexibility of the insertion tube by holding the insertion tube with two hands before inserting it into the patient, and adjust the flexibility as necessary according to the case, region and patient's condition during an examination. If you are unsure of the appropriate flexibility of the insertion tube, set it to the most-flexible condition. Continuing the examination while the insertion tube is set to an inappropriate degree of flexibility may cause patient pain, injury, bleeding and/or perforation (for endoscopes with flexibility adjustment only).

NOTE

Set the brightness of the light source to the minimum level necessary to perform the procedure safely. If the endoscope is used for a prolonged period at or near maximum light intensity, vapor may be observed in the endoscopic image. This is caused by the evaporation of organic material (blood, moisture in stool, etc.) due to heat generated by the light guide near the light guide lens. If this vapor continues to interfere with the examination, remove the endoscope, wipe the distal end with a lint-free cloth moistened with 70% ethyl or isopropyl alcohol, reinsert the endoscope and continue the examination.

4.1 Insertion

Holding and manipulating the endoscope

The control section of the endoscope is designed to be held in the left hand. The air/water and suction valves can be operated using the left index finger. The UP/DOWN angulation control knob can be operated using the left thumb. The right hand is free to manipulate the insertion tube and the RIGHT/LEFT angulation control knob (see Figure 4.1, the GIF-N180 has only the UP/DOWN angulation control knob).

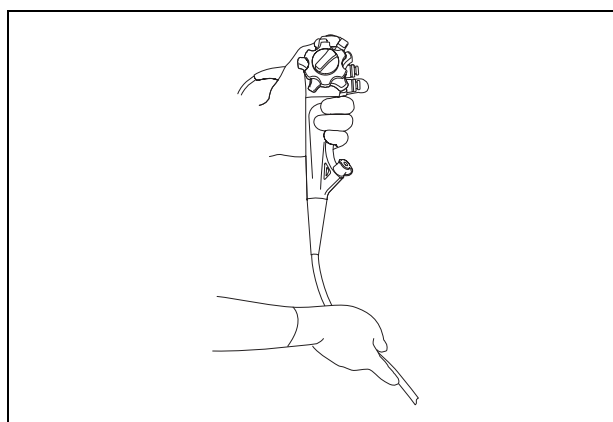

Figure 4.1

Insertion of the endoscope

WARNING

- The shape and size of the nasal cavity and its suitability for transnasal insertion may vary from patient to patient. No endoscope, including this one, can always be inserted transnasally with all patients. Before proceeding, always be sure to confirm that transnasal insertion is possible with the patient. Otherwise, operator and/or patient injury can result, or the endoscope could become lodged and be difficult to withdraw.
- Transnasal insertion of the endoscope should be performed carefully. If resistance to insertion is felt, or the patient reports pain, stop insertion immediately. Otherwise, operator and/or patient injury can result or the endoscope could become lodged and be difficult to withdraw.

CAUTION

- To prevent the patient from accidentally biting the insertion tube during an examination, it is strongly recommended that a mouthpiece be placed in the patient's mouth before inserting the endoscope (for GIF models only).
- To prevent the patient from accidentally losing dental prosthesis, make sure that the patient removes them before the examination.
- Do not apply olive oil or products containing petroleum-based lubricants (e.g. vaseline). These products may cause stretching and deterioration of the bending section's covering.
- Do not allow the insertion tube to be bent within a distance of 10 cm or less from the junction of the boot. Insertion tube damage can occur (see Figures 4.2 and 4.3).

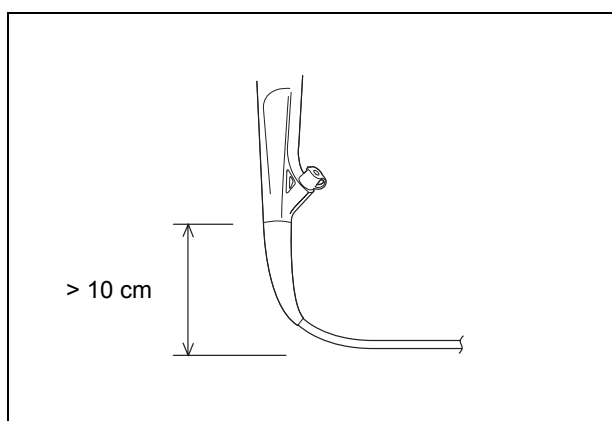

Figure 4.2

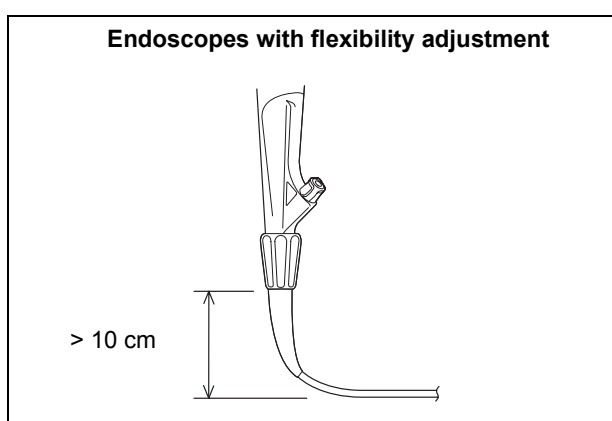

Figure 4.3

○ For GIF models

1. If necessary, apply a medical-grade, water-soluble lubricant to the insertion tube.
2. Place the mouthpiece between the patient's teeth or gums, with the outer flange on the outside of the patient's mouth. In case of transnasal insertion (for GIF-N180 only), the mouthpiece is not used.
3. Insert the distal end of the endoscope through the opening of the mouthpiece, then from the mouth to the pharynx, while viewing the endoscopic image. Do not insert the insertion tube into the mouth beyond the insertion tube limit mark.

○ For CF/PCF models

NOTE

To determine the correct splinting tube to use with the endoscope, select one of the combinations shown in the "Accessories (for CF/PCF models only)" table in the "Appendix" on page 91.

1. If necessary, apply a medical-grade, water-soluble lubricant to the insertion tube.
2. Insert the insertion tube of the endoscope into the splinting tube if required, and apply lubricant to the splinting tube.
3. Always view the endoscopic image when passing the distal end of the endoscope from the anus to the rectum. Do not insert the insertion tube into the anus beyond the insertion tube limit mark.

Angulation of the distal end

CAUTION

Avoid forcible or excessive angulation, as this imposes load on the wire controlling the bending section. This may cause stretching or tearing of the wire, which could impair the movement of the bending section.

1. Operate the angulation control knobs as necessary to guide the distal end for insertion and observation.
2. The endoscope's angulation locks are used to hold the angulated distal end in position.

NOTE

- When passing an endo-therapy accessory through the instrument channel while the angulation is locked, the angle of the distal end may change. When it is necessary to keep the angulation stationary, hold the angulation control knob(s) in place with your hand.
- When operating the UP/DOWN or RIGHT/LEFT angulation lock, hold the angulation control knob stationary with your finger. If this is not done, the angulation will change (the GIF-N180 has only the UP/DOWN angulation control knob).

Flexibility adjustment (for endoscopes with flexibility adjustment only)

WARNING

- Do not change the insertion tube's flexibility abruptly. Otherwise, patient pain, injury, bleeding and/or perforation can result.
- If the endoscopic image moves suddenly or is lost, while you are changing the insertion tube's flexibility, stop changing the flexibility and restore the optimal field of view. Moving the flexibility adjustment ring without a clear endoscopic image may cause patient pain, injury, bleeding and/or perforation.
- If the patient complains of pain, while you are changing the insertion tube's flexibility, stop changing the flexibility and ensure the safety of the patient.
- If the rigidity of the insertion tube has to be increased during an examination, confirm that there are no loops or excessive bends in the insertion tube (using fluoroscopy, if necessary) before increasing its rigidity. If the force required to turn the flexibility adjustment ring is greater during the procedure than it was when inspecting the endoscope, it may mean that the insertion tube is excessively bent inside the patient. In this case, straighten the insertion tube as much as possible before attempting to increase the rigidity. Failure to do so may cause patient pain, injury, bleeding and/or perforation.

1. Before inserting or withdrawing the endoscope, set the insertion tube to an appropriate level of flexibility by turning the flexibility adjustment ring as required (see Figure 4.4).

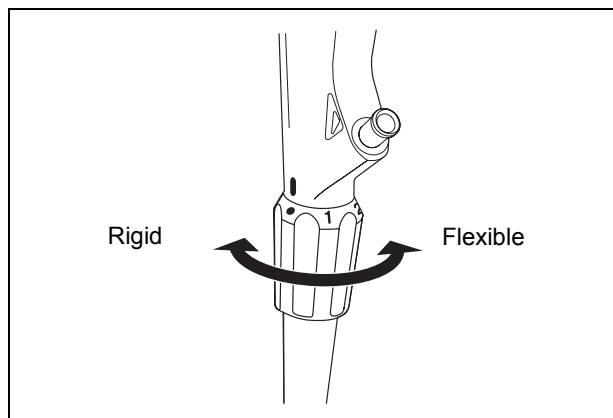

Figure 4.4

2. When changing the insertion tube's flexibility during a procedure, turn the flexibility adjustment ring slowly, and closely monitor the position of the flexibility marks, the endoscopic image and the patient's condition.

CAUTION

Whenever the endoscope is not in use, set the insertion tube to its most-flexible condition. Otherwise, endoscope damage may result.

Air/water feeding and suction

WARNING

- If the sterile water level in the water container is too low, then air, not water, will be supplied. In this case, turn the airflow regulator on the light source OFF and add sterile water to the water container until it reaches the specified water level.
- If air/water feeding does not stop, turn the airflow regulator on the light source OFF and replace the air/water valve with a new one.
- Before using a syringe to inject liquid through the biopsy valve, detach the valve's cap from the main body. Then insert the syringe straight into the valve and inject the liquid. If the cap is not detached and/or the syringe is not inserted straight, the biopsy valve could be damaged, which could reduce the efficacy of the endoscope's suction system, and may leak or spray patient debris or fluids, posing an infection-control risk.

- If the biopsy valve is left uncapped during the procedure, debris or fluids could leak or spray from it, posing an infection-control risk. When the valve is uncapped, place a piece of sterile gauze over it to prevent leakage.

NOTE

If the endoscope is cold, dew condensation may form on the surface of the objective lens, and the endoscopic image may appear cloudy. In this case, increase the temperature of the sterile water in the water container to between 40 – 50°C (104 – 122°F) and then use the endoscope.

○ Air/water feeding

1. Cover the air/water valve's hole to feed air from the air/water nozzle at the distal end (see Figure 4.5).
2. Depress the air/water valve to feed water onto the objective lens (see Figure 4.5).

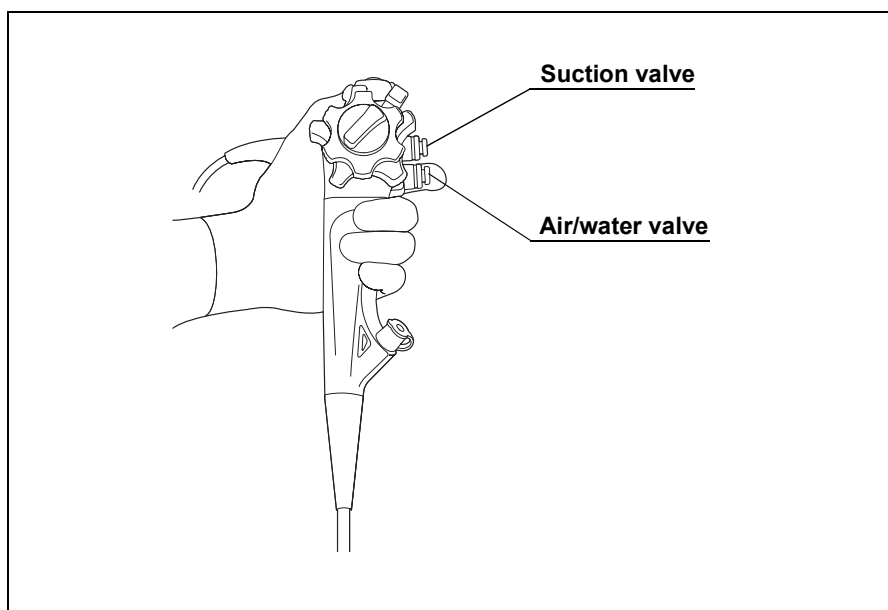

Figure 4.5

○ Suction

WARNING

- Avoid aspirating solid matter or thick fluids; channel or valve clogging can occur. If the suction valve clogs and suction cannot be stopped, disconnect the suction tube from the suction connector on the endoscope connector. Turn the suction pump OFF, detach the suction valve and remove solid matter or thick fluids.
- When aspirating, maintain the suction pressure at the lowest level necessary to perform the procedure. Excessive suction pressure could cause aspiration of and/or injury to the mucous membrane. In addition, patient fluids could leak or spray from the biopsy valve, posing an infection-control risk.
- When aspirating, attach the cap to the main body of the biopsy valve. The uncapped biopsy valve can reduce the efficacy of the endoscope's suction system, and may leak or spray patient debris or fluids, posing an infection-control risk.

CAUTION

During the procedure, take notice that the suction bottle does not fill completely. Aspirating fluids into a full bottle may cause the suction pump to malfunction.

Depress the suction valve to aspirate excess fluid or other debris obscuring the endoscopic image (see Figure 4.5).

NOTE

Performing both air feeding and suction at the same time sometimes makes it easier to remove water droplets from the objective lens surface.

○ Auxiliary water feeding (for endoscopes with auxiliary water feeding only)

WARNING

Use sterile water only. Non-sterile water may cause patient infection.

CAUTION

- Never disconnect the auxiliary water tube from the auxiliary water inlet during an examination; leave it attached until the endoscope is precleaned. If the auxiliary water tube is detached before precleaning, water remaining in the auxiliary water channel may be spilled on the equipment. This could cause damage and/or malfunction of the equipment.
 - When the auxiliary water tube is not connected to the auxiliary water inlet, be sure to have the auxiliary water inlet cap attached to the auxiliary water inlet. Otherwise, patient debris or fluids that back flowed may drip out of the auxiliary water inlet.
1. Attach a syringe containing sterile water or the water tube from a water pump to the luer port of the auxiliary water tube. Feed water.
 2. When disconnecting the syringe or the water tube from the water pump during examination, disconnect it directly from the luer port but leave the auxiliary water tube itself attached.

Observation of the endoscopic image

Refer to the light source's instruction manual for instructions on how to adjust the brightness.

Observation of the NBI image

All mucosal areas are to be viewed using traditional white light.

NBI*¹ imaging should not be used as a substitute for a thorough traditional examination of the mucosa.

- *1 NBI stands for Narrow Band Imaging. For more details, refer to the instruction manual of the CV-180.

4.2 Using endo-therapy accessories

For more information on combining the endoscope with particular endo-therapy accessories, refer to the “System chart” in the Appendix and the instruction manuals of the accessories. Refer to the accessories’ instruction manuals for operating instructions.

WARNING

- Do not use the GIF-N180 for high-frequency cauterization or laser cauterization treatment. Otherwise, patient injury or equipment damage may result.
- When using endo-therapy accessories, keep the distance between the distal end of the endoscope and the mucous membrane greater than the endoscope’s minimum visible distance so that the endo-therapy accessory remains visible in the endoscopic image. If the distal end of the endoscope is placed closer than its own minimum visible distance, the position of the accessory cannot be seen in the endoscopic image, which could cause serious patient injury and/or equipment damage. The minimum visible distance depends on the type of endoscope being used. Refer to Section 2.3, “Specifications” on page 24.
- When inserting or withdrawing an endo-therapy accessory, confirm that its distal end is closed or completely retracted into the sheath. Slowly insert or withdraw the endo-therapy accessory straight into/from the slit of the biopsy valve. Otherwise, the biopsy valve may be damaged and pieces of it could fall off.
- If the insertion or withdrawal of endo-therapy accessories is difficult, straighten the bending section as much as possible without losing the endoscopic image. Inserting or withdrawing endo-therapy accessories with excessive force may damage the instrument channel or endo-therapy accessories cause some parts to fall off and/or cause patient injury.
- If the distal end of an endo-therapy accessory is not visible in the endoscopic image, do not open the distal end or extend the needle of the instrument. This could cause patient injury, bleeding, perforation and/or equipment damage.

- When using endo-therapy accessories, always use the widest possible angle. When the image is magnified, it may not be possible to see the position of the accessory in the endoscopic image. This could cause patient injury, bleeding and/or perforation (when using the image magnification function of the video system center CV-180).
- When using a distal attachment, the distal end of the endoscope becomes longer and its outer diameter is larger. Handle the endoscope carefully so as not to cause perforation or other patient injury. When performing endoscopic treatment using this equipment, take extra care.

CAUTION

- When using a biopsy forceps with a needle, confirm that the needle is not bent excessively. A bent needle could protrude from the closed cups of the biopsy forceps. Using such a biopsy forceps could damage the instrument channel and/or cause patient injury.
- When using an injector, be sure not to extend or retract the needle from the catheter of the injector until the injector is extended from the distal end of the endoscope. The needle could damage the instrument channel if extended inside the channel, or if the injector is inserted or withdrawn while the needle is extended.

Insertion of endo-therapy accessories into the endoscope

WARNING

- Do not insert endo-therapy accessories forcibly or abruptly. Otherwise, the endo-therapy accessory may extend from the distal end of the endoscope abruptly, which could cause patient injury, bleeding and/or perforation.
- It is easier to insert an endo-therapy accessory into the instrument channel port if the biopsy valve's cap is detached from the main body (see Figure 3.11 on page 45). As a result, the open biopsy valve can reduce the efficacy of the endoscope's suction system, and may leak or spray patient debris or fluids, posing an infection-control risk. When not using an endo-therapy accessory, attach the cap to the main body of the biopsy valve.

- When the biopsy valve's cap is detached from the main body, it may cause patient debris or fluids to leak or spray from the endoscope, posing an infection-control risk. When the biopsy valve's cap has to be detached, place a piece of sterile gauze over it to prevent leakage.
 - Do not let the endo-therapy accessory "hang down" from the biopsy valve. Doing so can create a space between the accessory and the valve's slit or hole and/or damage the valve, which can reduce the efficacy of the endoscope's suction system, and may leak or spray patient debris or fluids, posing an infection-control risk.
 - When inserting an endo-therapy accessory, hold it close to the biopsy valve and insert it slowly and straight into the biopsy valve. Otherwise, the endo-therapy accessory and/or biopsy valve could be damaged. This can reduce the efficacy of the endoscope's suction system, and may leak or spray patient debris or fluids, posing an infection-control risk.
1. Select endo-therapy accessories compatible with the instrument from the "System chart" in the Appendix. Refer to the accessories' instruction manuals for operating instructions.
 2. Hold the UP/DOWN and RIGHT/LEFT angulation knobs stationary (the GIF-N180 has only the UP/DOWN angulation control knob).
 3. Confirm that the tip of the endo-therapy accessory is closed or retracted into its sheath and insert the endo-therapy accessory slowly and straight into the slit of the biopsy valve.

CAUTION

- Do not open the tip of the endo-therapy accessory or extend the tip of the endo-therapy accessory from its sheath while the accessory is in the instrument channel. The instrument channel and/or the endo-therapy accessory may become damaged.
 - Hold the endo-therapy accessory close to the biopsy valve and insert it straight into the biopsy valve using slow, short strokes. Otherwise, the endo-therapy accessory could bend or break.
4. Hold the endo-therapy accessory approximately 4 cm from the biopsy valve and advance it slowly and straight into the biopsy valve using short strokes while observing the endoscopic image.

NOTE

- When the tip of the endo-therapy accessory extends approximately 1 cm from the distal end of the endoscope, the accessory will appear in the endoscopic image.
- When the accessory appears in the endoscopic image, it may also reflect the light from the endoscope and/or cast its shadow in the endoscopic image. This does not indicate a malfunction (for GIF-N180 only).

Operation of endo-therapy accessories

Operate the endo-therapy accessory according to the directions given in its instruction manual.

Withdrawal of endo-therapy accessories

WARNING

- Patient debris might spray when the endo-therapy accessories are withdrawn from the biopsy valve. To prevent this, hold a piece of gauze around the accessory and the biopsy valve during withdrawal.
- Do not withdraw the endo-therapy accessory if the tip is open or extended from its sheath; patient injury, bleeding, perforation and/or instrument damage may occur.
- Withdraw the endo-therapy accessory slowly and straight out of the biopsy valve. Otherwise, the valve's slit and/or hole could be damaged. This can reduce the efficacy of the endoscope's suction system, and may leak or spray patient debris or fluids, posing an infection-control risk.
- If the endo-therapy accessory cannot be withdrawn from the endoscope, close the endo-therapy accessory and/or retract it into its sheath, then carefully withdraw both the endoscope and the endo-therapy accessory together under endoscopic observation. Take care not to cause tissue trauma.

Withdraw the endo-therapy accessory slowly while the tip of the endo-therapy accessory is closed and/or retracted into its sheath.

Use of non-flammable gases (for CF/PCF models only)

WARNING

Performing treatment while the intestines is filled with a flammable gas could result in an explosion, fire and/or serious patient injury. If the intestines contains a flammable gas, replace it with air or a non-flammable gas such as CO₂ before performing high-frequency treatment or laser cauterization treatment.

NOTE

Using CO₂ during endoscopic examinations of the colon and rectum, etc. may reduce post-examination pain.

When a non-flammable gas is used, only water containers MH-970 or MAJ-902 may be used with the endoscope. Carefully follow their instruction manuals.

High-frequency cauterization treatment (except GIF-N180)

WARNING

- If the intestines contains a flammable gas, replace it with air or a non-flammable gas such as CO₂ before performing high-frequency cauterization treatment. Otherwise, fire or explosion could result.
- Not all parts of the endoscope are electrically insulated. When applying high-frequency current, there is a danger of unintentional diathermy burns. Always wear electrically insulating chemical-resistant gloves.
- Never emit high-frequency current before confirming that the distal end of the high-frequency endo-therapy accessory is in the endoscope's field of view. Also confirm that the electrode section and the mucous membrane in the vicinity of the target area are at an appropriate distance from the distal end of the endoscope. If the high-frequency current is emitted while the distal end of the endo-therapy accessory is not visible or too close to the distal end of the endoscope, patient injury, bleeding and/or perforation as well as equipment damage can result.

Prepare, inspect and connect the electrosurgical unit and electrosurgical accessories as described in their instruction manuals.

NOTE

The application of high-frequency current may interfere with the endoscopic image. This does not indicate a malfunction.

Laser cauterization treatment (except GIF-N180)

WARNING

- Performing treatment while the intestines is filled with a flammable gas could result in an explosion, fire and/or serious patient injury. If the intestines contains a flammable gas, replace it with air or a non-flammable gas such as CO₂ before performing laser cauterization treatment.
- To avoid patient injury, burns, bleeding and/or perforation as well as damage to the endoscope, do not activate laser radiation before confirming that the tip of the laser probe appears in the proper position in the endoscopic image. Keep an appropriate distance between the target and the endoscope's distal end and always use the lowest power output possible.

CAUTION

- Before inserting or withdrawing the laser probe, return the UP/DOWN and RIGHT/LEFT angulation control knobs to their neutral positions (see Figure 3.6 on page 41) so that the bending section will be straight. If it is bent, the instrument channel and/or the laser probe may be damaged.
- Allow the tip of the laser probe to cool down before pulling it back into the instrument channel. If the laser probe is withdrawn while hot, channel damage may occur.
- Do not use a damaged laser probe. A laser probe with a damaged sheath or distal end may cause patient injury and/or equipment damage.

Prepare, inspect and connect the laser unit and laser probe as described in their instruction manuals.

4.3 Withdrawal of the endoscope

WARNING

- If blood unexpectedly adheres to the surface of the insertion tube of the withdrawn endoscope, carefully check the condition of the patient.
 - If it becomes impossible to withdraw the transnasally inserted endoscope, pull its distal end out of the mouth, cut the flexible tube using wire cutters, and after ensuring that the cut section will not injure the body cavity or nasal cavity of the patient, withdraw the endoscope carefully. Therefore, always prepare wire cutters in advance.
1. When using the image magnification function of the video system center CV-180, release the function.
 2. Aspirate accumulated air, blood, mucus or other debris by depressing the suction valve.
 3. Turn the UP/DOWN and RIGHT/LEFT angulation locks to the “F▶” direction to release them (the GIF-N180 has only the UP/DOWN angulation lock).
 4. Carefully withdraw the endoscope while observing the endoscopic image. When the splinting tube is used, withdraw both the endoscope and the splinting tube together from the patient's anus (for CF/PCF models only).
 5. Carefully withdraw the endoscope while observing the endoscopic image. Remove the mouthpiece from the patient's mouth (for GIF models only).

4.4 Transportation of the endoscope

Transporting within the hospital

1. Set the insertion tube to the most-flexible condition (for endoscopes with flexibility adjustment only).
2. When carrying the endoscope with the auxiliary water tube connected to the auxiliary water inlet, attach the clip of the auxiliary water tube to the universal cord (for endoscopes with auxiliary water feeding only, see Figure 4.6).

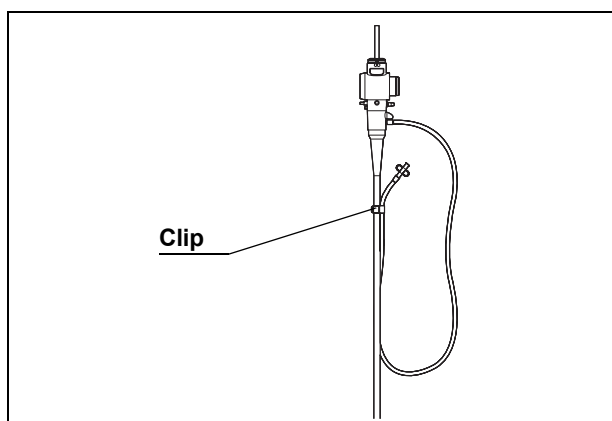

Figure 4.6

3. When carrying the endoscope by hand, loop the universal cord, hold the endoscope connector together with the control section in one hand and hold the distal end of the insertion tube securely, but gently without squeezing, in the other hand (see Figure 4.7).

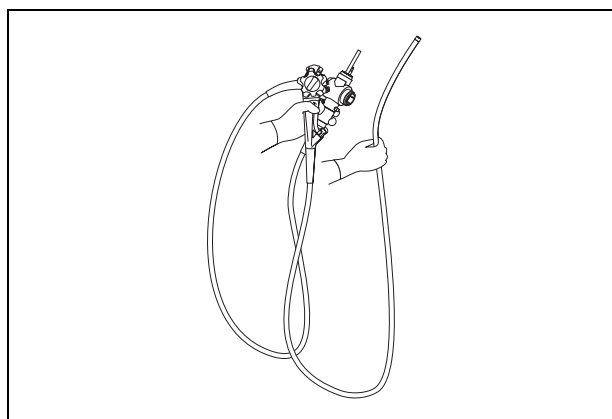

Figure 4.7

Transporting outside the hospital

Transport the endoscope in the carrying case.

WARNING

Always clean, disinfect or sterilize the endoscope after removing it from the carrying case. If the endoscope is not cleaned, disinfected or sterilized, it could pose an infection-control risk.

CAUTION

- The carrying case cannot be cleaned, disinfected or sterilized. Clean and disinfect or sterilize the endoscope before placing it in the carrying case.
- Do not attach the water-resistant cap when transporting the endoscope, to avoid damage to the endoscope caused by changes in air pressure.
- Before putting the endoscope in the carrying case, always make sure that the insertion tube is set to the most-flexible condition. Putting the endoscope in the carrying case while the insertion tube is rigid could damage the endoscope (for endoscopes with flexibility adjustment only).

Chapter 5 Troubleshooting

If the endoscope is visibly damaged, does not function as expected or is found to have irregularities during the inspection described in Chapter 3, "Preparation and Inspection", do not use the endoscope. Contact Olympus.

Some problems that appear to be malfunctions may be correctable by referring to Section 5.1, "Troubleshooting guide". If the problem cannot be resolved by the described remedial action, stop using the endoscope and send it to Olympus for repair.

Olympus does not repair accessory parts. If an accessory part becomes damaged, contact Olympus to purchase a replacement.

WARNING

- Never use the endoscope on a patient if an abnormality is suspected. Damage or irregularity in the instrument may compromise patient or user safety and may result in more severe equipment damage.
- If any parts of the endoscope fall off inside the patient body due to equipment damage or failure, stop using the endoscope immediately and retrieve the parts in an appropriate way.

If any abnormality in the function of the endoscope and/or endoscopic image is suspected during use, stop the examination immediately and carefully withdraw the endoscope from the patient as described in Section 5.2, "Withdrawal of the endoscope with an abnormality" on page 83.

5.1 Troubleshooting guide

The following table shows the possible causes of and countermeasures against troubles that may occur due to equipment setting errors or deterioration of consumables.

Troubles or failures due to other causes than those listed below should be serviced. As repair performed by persons who are not qualified by Olympus could cause patient or user injury and/or equipment damage, be sure to contact Olympus for repair following the instructions given in Section 5.3, "Returning the endoscope for repair" on page 86.

Endoscope functions

○ Angulation

Irregularity description	Possible cause	Solution
Resistance is encountered when rotating angulation control knob(s).	The angulation lock(s) is (are) engaged.	Rotate angulation lock(s) in the “F▶” direction.

○ Air/water feeding

Irregularity description	Possible cause	Solution
No air feeding.	The air pump is not operating.	Press the “LOW”, “MED” or “HIGH” button on the light source as described in the light source’s instruction manual.
	The air/water valve is damaged.	Replace it with a new one.
No water feeding.	The air pump is not operating.	Press the “LOW”, “MED” or “HIGH” button on the light source as described in the light source’s instruction manual.
	There is no sterile water in the water container.	Add sterile water to fill the container to the specified level.
	The air/water valve is damaged.	Replace it with a new one.
The air/water valve is sticky.	The air/water valve is dirty.	Remove the air/water valve. Reprocess the air/water valve and then attach it again.
	The air/water valve is damaged.	Replace it with a new one.
The air/water valve cannot be attached.	An incorrect air/water valve is used.	Use a correct air/water valve.
	The air/water valve is damaged.	Replace it with a new one.

○ Suction

Irregularity description	Possible cause	Solution
The suction is absent or insufficient.	The biopsy valve is not attached properly.	Attach it correctly.
	The biopsy valve is damaged.	Replace it with a new one.
	The suction pump is not set properly.	Adjust the suction pump's setting as described in its instruction manual.
	The suction valve is damaged.	Replace it with a new one.
The suction valve is sticky.	The suction valve is dirty.	Remove the suction valve. Reprocess the suction valve and attach it again.
	The suction valve is damaged.	Replace it with a new one.
The suction valve cannot be attached.	The suction valve is damaged.	Replace it with a new one.
	An incorrect suction valve is used.	Use a correct suction valve.
Liquid leaks out from the biopsy valve.	The biopsy valve is damaged.	Replace it with a new one.
	The biopsy valve is not attached properly.	Attach it correctly.

○ Image quality or brightness

Irregularity description	Possible cause	Solution
There is no video image.	Not all power switches are ON.	Turn all the power switches ON.
An image is not clear.	The objective lens is dirty.	Feed water to remove mucus, etc.
An image is excessively dark or bright.	The light source is not set properly.	Adjust the light source's setting as described in its instruction manual.
An image is abnormal.	An incompatible video system center is being used.	Select a compatible video system center.
	An incompatible light source is being used.	Select a compatible light source.

○ **Flexibility adjustment
(for endoscopes with flexibility adjustment only)**

Irregularity description	Possible cause	Solution
Too difficult to turn the flexibility adjustment ring.	The insertion tube is looped.	Straighten the insertion tube.

○ **Auxiliary water feeding
(for endoscopes with auxiliary water feeding only)**

Irregularity description	Possible cause	Solution
The auxiliary water inlet cap is leaking.	The auxiliary water inlet cap is worn out.	Replace it with a new one.
	The auxiliary water inlet cap is incorrectly installed.	Install the auxiliary water inlet cap correctly.

○ **Endo-therapy accessories**

Irregularity description	Possible cause	Solution
Endo-therapy accessory does not pass through the instrument channel smoothly.	An incompatible endo-therapy accessory is being used.	Refer to the “System chart” in the Appendix and select a compatible endo-therapy accessory. Confirm that the color code on the endo-therapy accessory matches that on the endoscope.

○ **Others**

Irregularity description	Possible cause	Solution
The remote switch does not work.	The wrong remote switch is operated.	Operate the correct remote switch.
	The remote switch function has been set improperly.	Set the remote switch function correctly as described in the video system center’s instruction manual.

5.2 *Withdrawal of the endoscope with an abnormality*

If an abnormality occurs while the endoscope is in use, take a proper measure as described in either “When the endoscopic image appears on the monitor” or “When the endoscopic image does not appear on the monitor or a frozen image cannot be restored” on page 85 below. After withdrawal, return the endoscope for repair as described in Section 5.3, “Returning the endoscope for repair” on page 86.

WARNING

If the endoscope or endo-therapy accessory cannot be withdrawn from the patient smoothly, do not attempt to forcibly withdraw it. If any irregularities are suspected, immediately contact Olympus. Forcibly withdrawing the endoscope or endo-therapy accessory may cause patient injury, bleeding and/or perforation.

When the endoscopic image appears on the monitor

1. Turn all equipment OFF except the video system center, light source and monitor.
2. When using the image magnification function of the video system center, release the function.
3. When using an endo-therapy accessory, close the tip of the endo-therapy accessory and/or retract it into its sheath. Then withdraw the endo-therapy accessory slowly.
4. Aspirate accumulated air, blood, mucus or other debris by depressing the suction valve.
5. When using an endoscope with the flexibility adjustment function, set the insertion tube to its most-flexible condition (for endoscopes with flexibility adjustment only).
6. Turn the UP/DOWN and RIGHT/LEFT angulation locks in the “F▶” direction to release them (the GIF-N180 has only the UP/DOWN angulation lock).
7. Carefully withdraw the endoscope while observing the endoscopic image. When the splinting tube is used, withdraw both the endoscope and the splinting tube together from the patient’s anus (for CF/PCF models only).
8. Carefully withdraw the endoscope while observing the endoscopic image. Remove the mouthpiece from the patient’s mouth (for GIF models only).

When the image magnification function is unavailable

1. Turn all equipment OFF except the video system center, light source and monitor.
2. When the image magnification function is unavailable on the video system center, turn the video system center OFF then ON again. If the image magnification function is still unavailable, follow the procedure of step 3. and below in “When the endoscopic image does not appear on the monitor or a frozen image cannot be restored” on page 85. When the image magnification function is restored, set the endoscopic image to wide angle and perform the following steps (when using the image magnification function of video system center CV-180).
3. When using an endo-therapy accessory, close the tip of the endo-therapy accessory and/or retract it into its sheath. Then withdraw the endo-therapy accessory slowly.
4. Aspirate accumulated air, blood, mucus or other debris by depressing the suction valve.
5. When using an endoscope with the flexibility adjustment function, set the insertion tube to its most-flexible condition (for endoscopes with flexibility adjustment only).
6. Turn the UP/DOWN and RIGHT/LEFT angulation locks in the “F▶” direction to release them (the GIF-N180 has only the UP/DOWN angulation lock).
7. Carefully withdraw the endoscope while observing the endoscopic image. When the splinting tube is used, withdraw both the endoscope and the splinting tube together from the patient’s anus (for CF/PCF models only).
8. Carefully withdraw the endoscope while observing the endoscopic image. Remove the mouthpiece from the patient’s mouth (for GIF models only).

When the endoscopic image does not appear on the monitor or a frozen image cannot be restored

1. Turn all equipment OFF except the video system center, the light source and the monitor.
2. Turn the video system center and light source OFF and then ON again. If the endoscopic image appears or the frozen image restored, follow the procedure given in “When the endoscopic image appears on the monitor” on page 83, beginning from step 2.
If the endoscopic image still does not appear or the frozen image cannot be restored, perform the following steps.
3. Turn the video system center, the light source and the monitor OFF.
4. When using an endo-therapy accessory, withdraw the endo-therapy accessory slowly while the tip of the endo-therapy accessory is closed and/or retracted into its sheath.
5. When using an endoscope with the flexibility adjustment function, set the insertion tube to the most-flexible condition (for endoscopes with flexibility adjustment only).
6. Turn the UP/DOWN and RIGHT/LEFT angulation locks in the “F▶” direction to release them (the GIF-N180 has only the UP/DOWN angulation lock).
7. Turn the UP/DOWN and RIGHT/LEFT angulation control knobs to their respective neutral positions (see Figures 3.6 and 3.7, the GIF-N180 has only the UP/DOWN angulation control knob).
8. Release the angulation control knobs and carefully withdraw the endoscope. When the splinting tube is used, withdraw both the endoscope and the splinting tube together from the patient’s anus (for CF/PCF models only).
9. Release the angulation control knobs and carefully withdraw the endoscope. Remove the mouthpiece from the patient’s mouth (for GIF models only).

5.3 Returning the endoscope for repair

WARNING

Thoroughly clean and high-level disinfect or sterilize the endoscope before returning it for repair. Improperly reprocessed equipment presents an infection-control risk to each person who handles the endoscope within the hospital or at Olympus.

Before returning the endoscope for repair, contact Olympus. With the endoscope, include a description of the malfunction or damage and the name and telephone number of the individual at your location who is most familiar with the problem. Also include a repair purchase order. When returning the endoscope for repair, follow the instructions given in “Transporting outside the hospital” on page 78.

Appendix

System chart

The recommended combinations of equipment and accessories that can be used with this instrument are listed below. Some items may not be available in some areas. New products released after the introduction of this instrument may also be compatible for use in combination with this instrument. For further details, contact Olympus.

WARNING

If combinations of equipment other than those shown below are used, the full responsibility is assumed by the medical treatment facility.

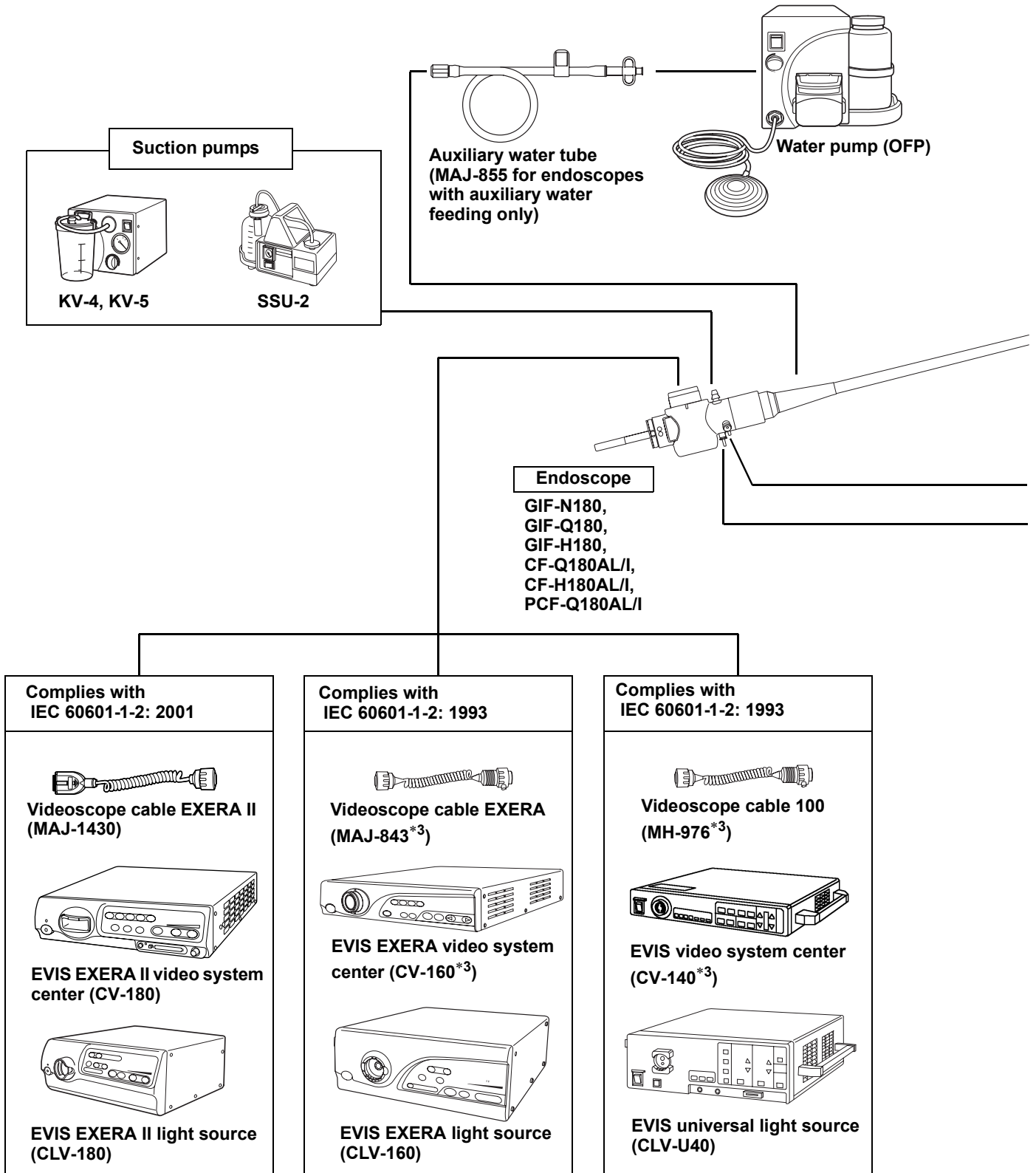

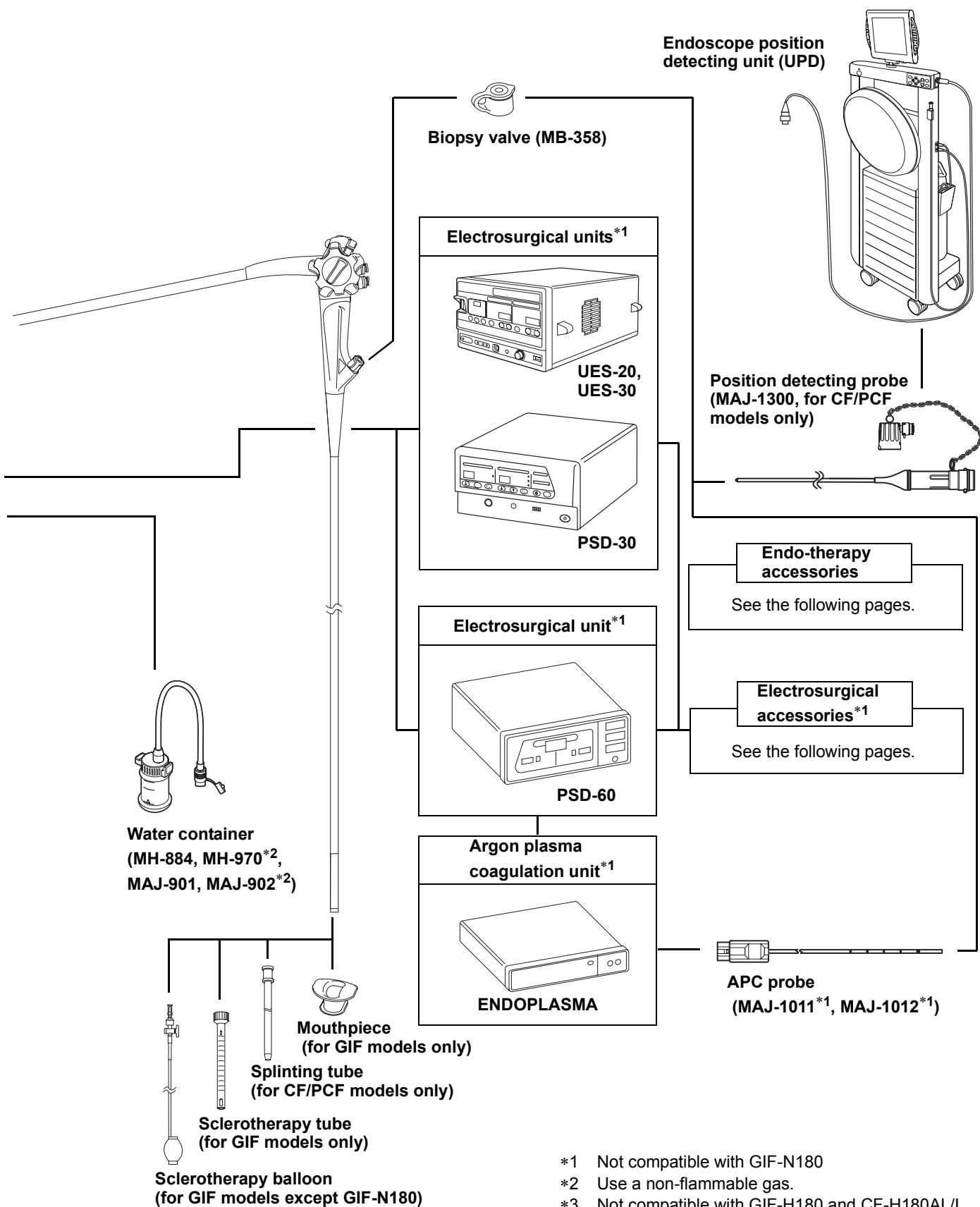

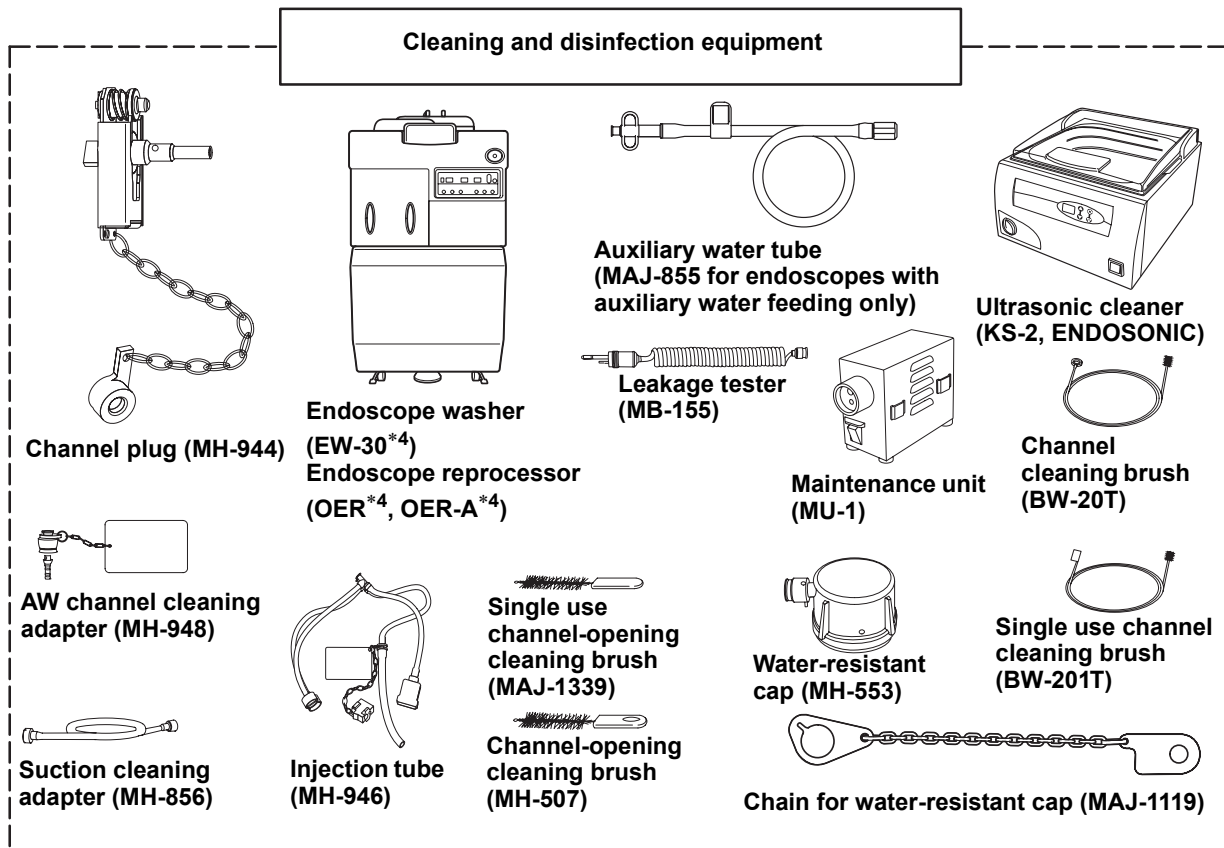

*4 These products may not be available in some areas.

○ Video system center

Endoscope	Videoscope cable 100	Videoscope cable EXERA	Videoscope cable EXERA II
	CV-140	CV-160	CV-180
GIF-N180	○	○	○
GIF-Q180	○	○	○
GIF-H180	–	–	○
CF-Q180AL/I	○	○	○
CF-H180AL/I	–	–	○
PCF-Q180AL/I	○	○	○

○ applicable – not applicable

○ Accessories (for GIF models only)

Endoscope	Mouthpiece		Sclerotherapy balloon	Sclerotherapy tube
	MB-142	MA-474	MD-690	ST-E1
GIF-N180	○	○	–	○
GIF-Q180	○	–	○	○
GIF-H180	○	–	○	○

○ applicable – not applicable

○ Accessories (for CF/PCF models only)

Endoscope	Splinting tube			
	ST-C3	ST-C3S	ST-C5	ST-C8*1
CF-Q180AL/I	○	○	–	○
CF-H180AL/I	○	○	–	○
PCF-Q180AL/I	–	–	○	–

○ applicable – not applicable

*1 This accessory may not be available in some areas.

○ Endo-therapy accessories

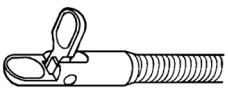
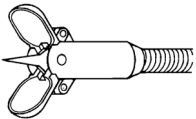
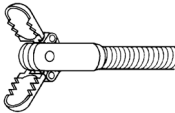
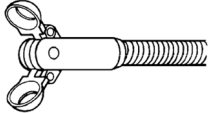
Endoscope	Biopsy forceps			Biopsy forceps (fenestrated)
	Single side open	With needle	Alligator jaws	Standard
				
GIF-N180	–	–	FB-15K-1	FB-19K-1, FB-21K-1
GIF-Q180	FB-11K-1	–	FB-15K-1	FB-25K-1
GIF-H180	FB-11K-1	–	FB-15K-1	FB-25K-1
CF-Q180AL	FB-7U-1	FB-13U-1	–	FB-28U-1
CF-Q180AI	FB-7U-1	FB-13Q-1	–	FB-28R-1
CF-H180AL	FB-7U-1	FB-13U-1	–	FB-28U-1
CF-H180AI	FB-7U-1	FB-13Q-1	–	FB-28R-1
PCF-Q180AL	FB-7U-1	–	–	FB-28U-1
PCF-Q180AI	FB-7U-1	–	–	FB-28R-1

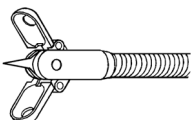
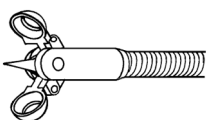
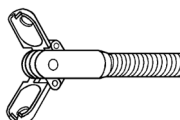
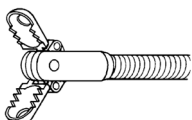
Endoscope	Biopsy forceps (fenestrated)			
	Elongated cups with needle	With needle	Rat tooth	Alligator jaws
				
GIF-N180	–	FB-34K-1	–	–
GIF-Q180	FB-24K-1	FB-23K-1	FB-37K-1	FB-36K-1
GIF-H180	FB-24K-1	FB-23K-1	FB-37K-1	FB-36K-1
CF-Q180AL	FB-24U-1	FB-50U-1	FB-37U-1	–
CF-Q180AI	FB-24Q-1	FB-50Q-1	FB-37U-1	–
CF-H180AL	FB-24U-1	FB-50U-1	FB-37U-1	–
CF-H180AI	FB-24Q-1	FB-50Q-1	FB-37U-1	–
PCF-Q180AL	FB-24U-1	–	FB-37U-1	–
PCF-Q180AI	FB-24Q-1	–	FB-37U-1	–

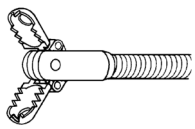
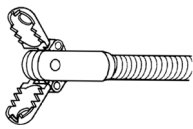
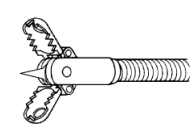
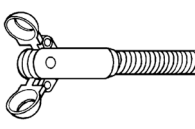
Endoscope	Biopsy forceps (fenestrated)			Rotatable biopsy forceps (fenestrated)
	Alligator jaws and rat tooth (swinging type)	Alligator jaws and rat tooth (swinging type/elongated cups)	Alligator jaws and rat tooth with needle (swinging type/elongated cups)	Standard type
				
GIF-N180	–	FB-52K-1	–	FB-19KR-1
GIF-Q180	FB-53K-1	FB-54K-1	FB-55K-1	FB-25KR-1
GIF-H180	FB-53K-1	FB-54K-1	FB-55K-1	FB-25KR-1
CF-Q180AL	FB-53U-1	FB-54U-1	FB-55U-1	–
CF-Q180AI	FB-53Q-1	FB-54Q-1	FB-55Q-1	–
CF-H180AL	FB-53U-1	FB-54U-1	FB-55U-1	–
CF-H180AI	FB-53Q-1	FB-54Q-1	FB-55Q-1	–
PCF-Q180AL	FB-53U-1	FB-54U-1	FB-55U-1	–
PCF-Q180AI	FB-53Q-1	FB-54Q-1	FB-55Q-1	–

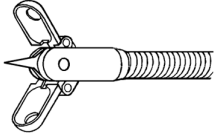
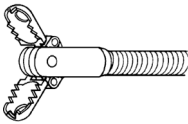
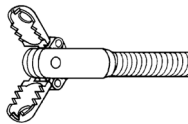
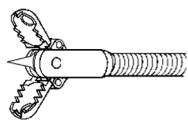
Endoscope	Rotatable biopsy forceps (fenestrated)			
	Elongated cups with needle	Alligator jaws and rat tooth (swinging type)	Alligator jaws and rat tooth (swinging type/elongated cups)	Alligator jaws and rat tooth with needle (swinging type/elongated cups)
				
GIF-N180	-	-	-	-
GIF-Q180	FB-24KR-1	FB-53KR-1	FB-54KR-1	FB-55KR-1
GIF-H180	FB-24KR-1	FB-53KR-1	FB-54KR-1	FB-55KR-1
CF-Q180AL	-	-	-	-
CF-Q180AI	-	-	-	-
CF-H180AL	-	-	-	-
CF-H180AI	-	-	-	-
PCF-Q180AL	-	-	-	-
PCF-Q180AI	-	-	-	-

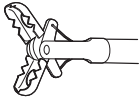
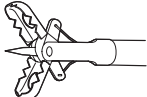
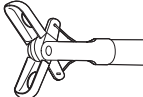
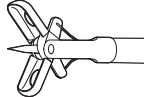
Endoscope	Disposable biopsy forceps			
	Alligator jaws-step	Alligator jaws-step with needle	Oval	Oval with needle
				
GIF-N180	FB-211K	FB-221K	FB-231K	FB-241K
GIF-Q180	FB-210K	FB-220K	FB-230K	FB-240K
GIF-H180	FB-210K	FB-220K	FB-230K	FB-240K
CF-Q180AL	FB-212U	FB-222U	FB-232U	FB-242U
CF-Q180AI	FB-212U	FB-222U	FB-232U	FB-242U
CF-H180AL	FB-212U	FB-222U	FB-232U	FB-242U
CF-H180AI	FB-212U	FB-222U	FB-232U	FB-242U
PCF-Q180AL	FB-210U	FB-220U	FB-230U	FB-240U
PCF-Q180AI	FB-210U	FB-220U	FB-230U	FB-240U

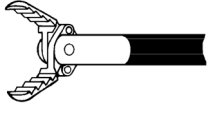
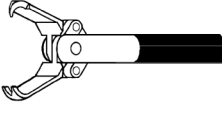
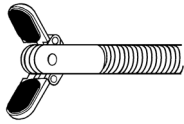
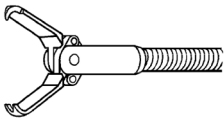

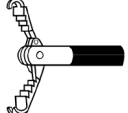
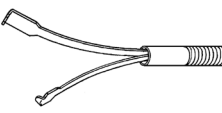
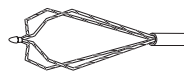
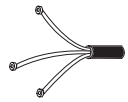
Endoscope	Grasping forceps			
	Alligator jaws	Rat tooth	Covered tips	Shark tooth
				
GIF-N180	–	FG-14P-1	FG-20P-1	–
GIF-Q180	FG-6L-1	FG-8L-1, FG-48L-1, FG-50L-1	FG-21L-1	FG-32L-1
GIF-H180	FG-6L-1	FG-8L-1, FG-48L-1, FG-50L-1	FG-21L-1	FG-32L-1
CF-Q180AL	FG-7U-1	FG-9U-1	–	–
CF-Q180AI	FG-7U-1	FG-9U-1	–	–
CF-H180AL	FG-7U-1	FG-9U-1	–	–
CF-H180AI	FG-7U-1	FG-9U-1	–	–
PCF-Q180AL	FG-6U-1	FG-8U-1	–	–
PCF-Q180AI	FG-6U-1	FG-8U-1	–	–

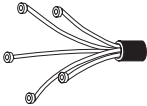
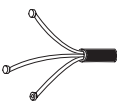
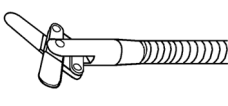
Endoscope	Grasping forceps			
	Rat tooth with alligator jaws	W shape jaw	Basket type	Tripod type
				
GIF-N180	–	FG-4L-1	FG-17K-1	–
GIF-Q180	FG-42L-1, FG-47L-1, FG-49L-1	FG-4L-1	FG-16L-1	FG-45L-1
GIF-H180	FG-42L-1, FG-47L-1, FG-49L-1	FG-4L-1	FG-16L-1	FG-45L-1
CF-Q180AL	–	–	FG-16U-1	FG-45U-1
CF-Q180AI	–	–	FG-16U-1	FG-45U-1
CF-H180AL	–	–	FG-16U-1	FG-45U-1
CF-H180AI	–	–	FG-16U-1	FG-45U-1
PCF-Q180AL	–	–	FG-16U-1	FG-45U-1
PCF-Q180AI	–	–	FG-16U-1	FG-45U-1

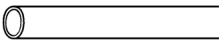
Endoscope	Grasping forceps	Single use grasping forceps	Surgical scissors	Loop cutter
	Pentapod type	Tripod type		
				
GIF-N180	-	-	-	-
GIF-Q180	FG-46L-1	FG-600U	FS-3L-1	FS-5L-1
GIF-H180	FG-46L-1	FG-600U	FS-3L-1	FS-5L-1
CF-Q180AL	FG-46U-1	FG-600U	-	FS-5U-1
CF-Q180AI	FG-46U-1	FG-600U	-	FS-5Q-1
CF-H180AL	FG-46U-1	FG-600U	-	FS-5U-1
CF-H180AI	FG-46U-1	FG-600U	-	FS-5Q-1
PCF-Q180AL	FG-46U-1	FG-600U	-	FS-5U-1
PCF-Q180AI	FG-46U-1	FG-600U	-	FS-5Q-1

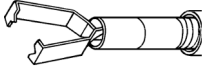
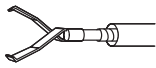
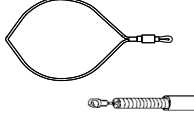
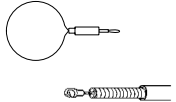

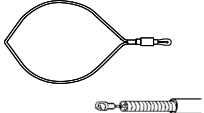
Endoscope	Washing pipe	
	Standard type	Spray type
		
GIF-N180	PW-2L-1	PW-6P-1
GIF-Q180	PW-1L-1	PW-5L-1
GIF-H180	PW-1L-1	PW-5L-1
CF-Q180AL	PW-1V-1	PW-5V-1
CF-Q180AI	PW-1V-1	PW-5V-1
CF-H180AL	PW-1V-1	PW-5V-1
CF-H180AI	PW-1V-1	PW-5V-1
PCF-Q180AL	PW-1V-1	PW-5V-1
PCF-Q180AI	PW-1V-1	PW-5V-1

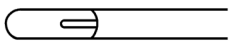
Endoscope	Clip fixing device	Single use rotatable clip fixing device	Ligating device	
				
GIF-N180	-	-	-	-
GIF-Q180	HX-5LR-1	HX-201LR-135	HX-20L-1*1	HX-21L-1*1
GIF-H180	HX-5LR-1	HX-201LR-135	HX-20L-1*1	HX-21L-1*1
CF-Q180AL	HX-6UR-1	HX-201UR-135	HX-20U-1*1	-
CF-Q180AI	HX-5QR-1	HX-201UR-135	HX-20Q-1*1	-
CF-H180AL	HX-6UR-1	HX-201UR-135	HX-20U-1*1	-
CF-H180AI	HX-5QR-1	HX-201UR-135	HX-20Q-1*1	-
PCF-Q180AL	HX-6UR-1	HX-201UR-135	HX-20U-1*1	-
PCF-Q180AI	HX-5QR-1	HX-201UR-135	HX-20Q-1*1	-

Endoscope	Ligating device	Injection needle	Disposable injection needle	Heat probe
				
GIF-N180	-	NM-8L-1, NM-9L-1	NM-201L	-
GIF-Q180	HX-400U-30	NM-4L-1, NM-5L-1, NM-6L-1, NM-7L-1	NM-200L, NM-201L	CD-21Z, CD-120U
GIF-H180	HX-400U-30	NM-4L-1, NM-5L-1, NM-6L-1, NM-7L-1	NM-200L, NM-201L	CD-21Z, CD-120U
CF-Q180AL	HX-400U-30	NM-4U-1	NM-200U	CD-11Z, CD-110U
CF-Q180AI	HX-400U-30	NM-4U-1	NM-200U	CD-11Z, CD-110U
CF-H180AL	HX-400U-30	NM-4U-1	NM-200U	CD-11Z, CD-110U
CF-H180AI	HX-400U-30	NM-4U-1	NM-200U	CD-11Z, CD-110U
PCF-Q180AL	HX-400U-30	NM-4U-1	NM-200U	CD-21Z, CD-120U
PCF-Q180AI	HX-400U-30	NM-4U-1	NM-200U	CD-21Z, CD-120U

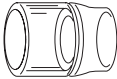
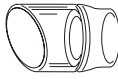
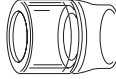
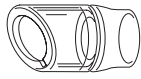

*1 These accessories may not be available in some areas.

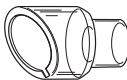



Endoscope	Distal attachment			
	Straight	Oblique	Straight with rim	Oblique with rim
				
GIF-N180	-	-	-	-
GIF-Q180	MH-462* ¹	MH-587* ¹	MH-593* ¹	MAJ-289* ¹
GIF-H180	MH-463* ¹	MH-588* ¹	MH-594* ¹	MAJ-290* ¹
CF-Q180AL	MH-466* ¹	MH-591* ¹	MH-597* ¹	MAJ-293* ¹
CF-Q180AI	MH-466* ¹	MH-591* ¹	MH-597* ¹	MAJ-293* ¹
CF-H180AL	MH-466* ¹	MH-591* ¹	MH-597* ¹	MAJ-293* ¹
CF-H180AI	MH-466* ¹	MH-591* ¹	MH-597* ¹	MAJ-293* ¹
PCF-Q180AL	MH-464* ¹	MH-589* ¹	MH-595* ¹	MAJ-291* ¹
PCF-Q180AI	MH-464* ¹	MH-589* ¹	MH-595* ¹	MAJ-291* ¹

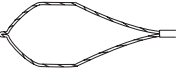

Endoscope	Distal attachment	Disposable distal attachment	
			
GIF-N180	-	-	-
GIF-Q180	MAJ-295* ¹	-	D-206-02* ¹
GIF-H180	MAJ-296* ¹	D-201-11804* ¹	D-206-04* ¹
CF-Q180AL	-	D-201-14304* ¹	-
CF-Q180AI	-	D-201-14304* ¹	-
CF-H180AL	-	D-201-15004* ¹	-
CF-H180AI	-	D-201-15004* ¹	-
PCF-Q180AL	MAJ-297* ¹	D-201-12704* ¹	-
PCF-Q180AI	MAJ-297* ¹	D-201-12704* ¹	-



*1 These accessories may not be available in some areas.

○ Electrosurgical accessories

Endoscope	Polypectomy snare			
	Crescent	Hexagonal	Oval	Mini-oval
				
GIF-N180	-	-	-	-
GIF-Q180	SD-5L-1	SD-6L-1	SD-9L-1, SD-11L-1	SD-12L-1, SD-13L-1
GIF-H180	SD-5L-1	SD-6L-1	SD-9L-1, SD-11L-1	SD-12L-1, SD-13L-1
CF-Q180AL	SD-5U-1	SD-6U-1	SD-9U-1, SD-11U-1	SD-12U-1, SD-13U-1
CF-Q180AI	SD-5U-1	SD-6U-1	SD-9U-1, SD-11U-1	SD-12U-1, SD-13U-1
CF-H180AL	SD-5U-1	SD-6U-1	SD-9U-1, SD-11U-1	SD-12U-1, SD-13U-1
CF-H180AI	SD-5U-1	SD-6U-1	SD-9U-1, SD-11U-1	SD-12U-1, SD-13U-1
PCF-Q180AL	SD-5U-1	SD-6U-1	SD-9U-1, SD-11U-1	SD-12U-1, SD-13U-1
PCF-Q180AI	SD-5U-1	SD-6U-1	SD-9U-1, SD-11U-1	SD-12U-1, SD-13U-1

Endoscope	Polypectomy snare		Disposable polypectomy snare	
	Oval with spike	Mini oval with spike	Oval	Mini-oval
				
GIF-N180	-	-	-	-
GIF-Q180	SD-16L-1	SD-17L-1	SD-210U-25	SD-210U-15
GIF-H180	SD-16L-1	SD-17L-1	SD-210U-25	SD-210U-15
CF-Q180AL	SD-16U-1	SD-17U-1	SD-210U-25	SD-210U-15
CF-Q180AI	SD-16U-1	SD-17U-1	SD-210U-25	SD-210U-15
CF-H180AL	SD-16U-1	SD-17U-1	SD-210U-25	SD-210U-15
CF-H180AI	SD-16U-1	SD-17U-1	SD-210U-25	SD-210U-15
PCF-Q180AL	SD-16U-1	SD-17U-1	SD-210U-25	SD-210U-15
PCF-Q180AI	SD-16U-1	SD-17U-1	SD-210U-25	SD-210U-15

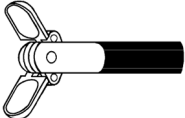
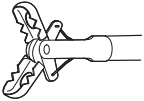
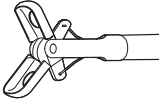
Endoscope	Disposable polypectomy snare		
	Extra mini-oval	Crescent	Oval (with spiral)
			
GIF-N180	-	-	-
GIF-Q180	SD-210U-10	SD-221L-25	SD-230U-20
GIF-H180	SD-210U-10	SD-221L-25	SD-230U-20
CF-Q180AL	SD-210U-10	SD-221U-25	SD-230U-20
CF-Q180AI	SD-210U-10	SD-221U-25	SD-230U-20
CF-H180AL	SD-210U-10	SD-221U-25	SD-230U-20
CF-H180AI	SD-210U-10	SD-221U-25	SD-230U-20
PCF-Q180AL	SD-210U-10	SD-221U-25	SD-230U-20
PCF-Q180AI	SD-210U-10	SD-221U-25	SD-230U-20

Endoscope	Hot biopsy forceps	Disposable hot biopsy forceps		Diathermic cutter
		Alligator jaws-step	Oval	Needle type
				
GIF-N180	-	-	-	-
GIF-Q180	FD-1L-1	FD-210U	FD-230U	KD-1L-1
GIF-H180	FD-1L-1	FD-210U	FD-230U	KD-1L-1
CF-Q180AL	FD-2U-1	FD-210U	FD-230U	-
CF-Q180AI	FD-2U-1	FD-210U	FD-230U	-
CF-H180AL	FD-2U-1	FD-210U	FD-230U	-
CF-H180AI	FD-2U-1	FD-210U	FD-230U	-
PCF-Q180AL	FD-1U-1	FD-210U	FD-230U	-
PCF-Q180AI	FD-1U-1	FD-210U	FD-230U	-

EMC information

This model is intended for use in the electromagnetic environments specified below. The user and the medical staff should ensure that it is used only in these environments.

○ Magnetic emission compliance information and recommended electromagnetic environments

Emission standard	Compliance	Guidance
RF emissions CISPR 11	Group 1	This instrument uses RF (Radio Frequency) energy only for its internal function. Therefore, its RF emissions are very low and are not likely to cause any interference in nearby electronic equipment.
Radiated emissions CISPR 11	Class B	This instrument's RF emissions are very low and are not likely to cause any interference in nearby electronic equipment.
Main terminal conducted emissions CISPR 11		
Harmonic emissions IEC 61000-3-2	Class A	This instrument's harmonic emissions are low and are not likely to cause any problem in the typical commercial power supply connected to this instrument.
Voltage fluctuations/flicker emissions IEC 61000-3-3	Complies	This instrument stabilizes its own radio variability and has no affect such as flicker in lighting apparatus.

○ Electromagnetic immunity compliance information and recommended electromagnetic environments

Immunity test	IEC 60601-1-2 test level	Compliance level	Guidance
Electrostatic discharge (ESD) IEC 61000-4-2	Contact: $\pm 2, \pm 4, \pm 6$ kV Air: $\pm 2, \pm 4, \pm 8$ kV	Same as left	Floors should be made of wood, concrete, or ceramic tile that hardly produces static. If floors are covered with synthetic material that tends to produce static, the relative humidity should be at least 30%.
Electrical fast transient/burst IEC 61000-4-4	± 2 kV for power supply lines ± 1 kV for input/output lines	Same as left	Mains power quality should be that of a typical commercial (original condition feeding the facilities) or hospital environment.
Surge IEC 61000-4-5	Differential mode: $\pm 0.5, \pm 1$ kV Common mode: $\pm 0.5, \pm 1, \pm 2$ kV	Same as left	Mains power quality should be that of a typical commercial or hospital environment.
Voltage dips, short interruptions and voltage variations on power supply input lines IEC 61000-4-11	$< 5\% U_T$ ($> 95\%$ dip in U_T) for 0.5 cycle <hr/> $40\% U_T$ (60% dip in U_T) for 5 cycle <hr/> $70\% U_T$ (30% dip in U_T) for 25 cycle <hr/> $< 5\% U_T$ ($> 95\%$ dip in U_T) for 5 seconds	Same as left	Mains power quality should be that of a typical commercial or hospital environment. If the user of this instrument requires continued operation during power mains interruptions, it is recommended that this instrument be powered from an uninterruptible power supply or a battery.
Power frequency (50/60 Hz) magnetic field IEC 61000-4-8	3 A/m	Same as left	It is recommended to use this instrument by maintaining enough distance from any equipment that operates with high current.

NOTE

U_T is the AC mains power supply prior to application of the test level.

○ **Cautions and recommended electromagnetic environment regarding portable and mobile RF communications equipment such as cellular phones**

Immunity test	IEC 60601-1-2 test level	Compliance level	Guidance
			Formula for recommended separation distance ($V_1=E_1=3$ according to the compliance level)
Conducted RF IEC 61000-4-6	3 Vrms (150 kHz – 80 MHz)	3 V (V_1)	$d = \left[\frac{3.5}{V_1} \right] \sqrt{P}$
Radiated RF IEC 61000-4-3	3 V/m (80 MHz – 2.5 GHz)	3 V/m (E_1)	$d = \left[\frac{3.5}{E_1} \right] \sqrt{P}$ 80 MHz – 800 MHz $d = \left[\frac{7}{E_1} \right] \sqrt{P}$ 800 MHz – 2.5 GHz

NOTE

- Where “P” is the maximum output power rating of the transmitter in watts (W) according to the transmitter manufacturer and “d” is the recommended separation distance in meters (m).
- This instrument complies with the requirements of IEC 60601-1-2: 2001. However, under electromagnetic environment that exceeds its noise level, electromagnetic interference may occur on this instrument.
- Electromagnetic interference may occur on this instrument near a high-frequency electrosurgical equipment and/or other equipment marked with the following symbol:



○ Recommended separation distance between portable and mobile RF communications equipment and this instrument

Rated maximum output power of transmitter P (W)	Separation distance according to frequency of transmitter (m) (calculated as $V_1=3$ and $E_1=3$)		
	150 kHz – 80 MHz	80 MHz – 800 MHz	800 MHz – 2.5 GHz
	$d = 1.2\sqrt{P}$	$d = 1.2\sqrt{P}$	$d = 2.3\sqrt{P}$
0.01	0.12	0.12	0.23
0.1	0.38	0.38	0.73
1	1.2	1.2	2.3
10	3.8	3.8	7.3
100	12	12	23

NOTE

The guidance may not apply in some situations. Electromagnetic propagation is affected by absorption and reflection from structures, objects and people. Portable and mobile RF communications equipment such as cellular phones should be used no closer to any part of this instrument, including cables than the recommended separation distance calculated from the equation applicable to the frequency of the transmitter.



©2005 OLYMPUS MEDICAL SYSTEMS CORP. All rights reserved.
No part of this publication may be reproduced or distributed without the
express written permission of OLYMPUS MEDICAL SYSTEMS CORP.

OLYMPUS is a registered trademark of OLYMPUS CORPORATION.

Trademarks, product names, logos, or trade names used in this
document are generally registered trademarks or trademarks of each
company.



OLYMPUS®

Manufactured by



OLYMPUS MEDICAL SYSTEMS CORP.

2951 Ishikawa-cho, Hachioji-shi, Tokyo 192-8507, Japan
Fax: (042)646-2429 Telephone: (042)642-2111

Distributed by

OLYMPUS AMERICA INC.

3500 Corporate Parkway, P.O. Box 610 Center Valley, PA
18034-0610, U.S.A.
Fax: (484)896-7128 Telephone: (484)896-5000

OLYMPUS SURGICAL & INDUSTRIAL AMERICA INC.

One Corporate Drive, Orangeburg, N.Y. 10962, U.S.A.
Fax: (845)398-9444 Telephone: (845)398-9400

OLYMPUS LATIN AMERICA, INC.

5301 Blue Lagoon Drive, Suite 290 Miami, FL 33126-2097, U.S.A.
Fax: (305)261-4421 Telephone: (305)266-2332



OLYMPUS MEDICAL SYSTEMS EUROPA GMBH

(Premises/Goods delivery) Wendenstrasse 14-18, 20097 Hamburg, Germany
(Letters) Postfach 10 49 08, 20034 Hamburg, Germany Telephone: (040)237730



KEYMED LTD.

KeyMed House, Stock Road, Southend-on-Sea, Essex SS2 5QH, United Kingdom
Fax: (01702)465677 Telephone: (01702)616333

OLYMPUS MOSCOW LIMITED LIABILITY COMPANY

117071, Moscow, Malaya Kaluzhskaya 19, bld. 1, fl.2, Russia
Fax: (095)958-2277 Telephone: (095)958-2245

OLYMPUS (BEIJING) SALES & SERVICE CO.,LTD.

Room 1202, NCI Tower, A21 Jianguomenwai Avenue Chaoyang
District Beijing 100022 PRC
Fax: (10)6569-3545 Telephone: (10)6569-3535

OLYMPUS KOREA CO.,LTD.

8F, Hyundai Marines Bldg., 646-1, Yeoksam-Dong, Kangnam-Gu, Seoul 135-080 Korea
Fax: (02)6255-3499 Telephone: (02)1544-3200

OLYMPUS SINGAPORE PTE LTD.

491B, River Valley Road #12-01/04, Valley Point Office Tower, Singapore 248373
Fax: 6834-2438 Telephone: 6834-0010

OLYMPUS AUSTRALIA PTY. LTD.

31 Gilby Road, Mount Waverley, VIC., 3149, Australia
Fax: (03)9543-1350 Telephone: (03)9265-5400

