

Aestiva/5

Operation Manual - Part 1

Software Revision 4.X

System Controls, Operation, Checkout



User Responsibility

This Product will perform in conformity with the description thereof contained in this Operation manual and accompanying labels and/or inserts, when assembled, operated, maintained, and repaired in accordance with the instructions provided. This Product must be checked periodically. A defective Product should not be used. Parts that are broken, missing, plainly worn, distorted, or contaminated should be replaced immediately. Should repair or replacement become necessary, Datex-Ohmeda recommends that a telephonic or written request for service advice be made to the nearest Datex-Ohmeda Customer Service Center. This Product or any of its parts should not be repaired other than in accordance with written instructions provided by Datex-Ohmeda and by Datex-Ohmeda trained personnel. The Product must not be altered without the prior written approval of Datex-Ohmeda. The user of this Product shall have the sole responsibility for any malfunction which results from improper use, faulty maintenance, improper repair, damage, or alteration by anyone other than Datex-Ohmeda.

CAUTION

U.S. Federal law restricts this device to sale by or on the order of a licensed medical practitioner. Outside the U.S.A., check local laws for any restriction that may apply.

Datex-Ohmeda products have unit serial numbers with coded logic which indicates a product group code, the year of manufacture, and a sequential unit number for identification.

AAA F 12345



This alpha character indicates the year of product manufacture and when the serial number was assigned; “D” = 2000, “E” = 2001, “F” = 2002, etc. “I” and “O” are not used.



Aestiva, S/5, PSVPro, Tec 5, Tec 6 and **Tec 7** are registered trademarks of Datex-Ohmeda Inc.

Other brand names or product names used in this manual are trademarks or registered trademarks of their respective holders.

1/Introduction

How to use this manual	1-2
What is an Aestiva?	1-2
Ventilators and monitors	1-3
Symbols used in the manual or on the equipment	1-5

2/System Controls and Menus

Anesthesia system controls	2-2
Breathing system controls	2-5
Vaporizer controls	2-9
Ventilator controls	2-11
Optional features	2-11
Control panel	2-11
How to set controls	2-14
How to use the menu	2-15
Menu map	2-16
More about menu functions	2-17
How to change menu settings	2-18
Optional flowmeter and suction regulators	2-19
Suction regulator controls	2-20
External flowmeter controls	2-20
Optional CO ₂ Bypass mode operation	2-21

3/Operation and Tutorial

Turn On the system	3-2
Set the alarm loudness	3-3
Show or hide alarm limits and units	3-5
Adjust patient data for Heliox	3-7
Turn the volume alarms on or off	3-8
Set alarm limits	3-9
Set an audible alarm for circuit leaks	3-11
Set Cardiac Bypass	3-12

Start mechanical ventilation	3-14
Stop mechanical ventilation	3-15
Set the ventilation mode	3-16
Set ventilator controls	3-18
Optional features	3-18
Ventilator controls.	3-19
Volume Control mode.	3-20
Pressure Control mode.	3-20
SIMV mode	3-20
PSVPro mode	3-21
Set inspiratory pause (volume mode)	3-22
Set SIMV and PSVPro controls	3-24
Silence alarms	3-26
Reading the pressure waveform (Paw)	3-27
Scales	3-27
Measure circuit compliance	3-30
Show the service settings	3-31
Optional Passive AGSS operation	3-33
Optional Active AGSS operation	3-34
Connecting Active AGSS with a flow indicator	3-35
Connecting Active AGSS without a flow indicator	3-36

4/Preoperative Checklist

Every day before the first patient	4-2
Every time a different clinician uses the system	4-3
Before every patient	4-3

Appendix - Preoperative Tests

Test Intervals	A-2
Every day before the first patient	A-3
Inspect the System	A-3
Minimize alarms (optional)	A-5

Pipeline and cylinder tests A-5

Flow control tests A-7

Vaporizer back pressure test A-8

Power failure test A-9

Precase steps A-11

Every time a different clinician uses the system A-12

 Low-pressure leak test A-12

Before every patient A-16

 Inspect the system A-16

 Minimize alarms (optional) A-18

 Breathing system tests A-19

 Monitor and ventilator tests A-21

Index

Warranty

Aestiva

1 Introduction

In this section

How to use this manual	1-2
What is an Aestiva?.....	1-2
Symbols used in the manual or on the equipment	1-5

How to use this manual

The Aestiva comes with several user manuals. This manual describes the controls and how to use them.

Section 1 shows the different models and supplies information about the symbols used on the equipment.

Section 2 shows control locations.

Section 3 tells you how to use the controls.

Section 4 is a two-page, preoperative checklist.

The appendix provides complete instructions for the preoperative tests shown on the checklist.

The Aestiva/5 7900 can be equipped with several optional ventilation functions. References made in this manual to Heliox mode, and SIMV and PSVPro modes, are only applicable to systems equipped with these functions.

Use this manual together with Part 2, which includes setup, troubleshooting, calibration, and maintenance procedures.

What is an Aestiva?

The Aestiva is a flexible, accessible and intuitive anesthesia delivery system. A wide selection of frames, gases, and vaporizers give you full control of the system configuration.

Options include pendant mounted systems, extra gas cylinders or vaporizers, and left or right-hand breathing systems.

Model	2 Vap. Trolley	3 Vap. Trolley	Pendant
Number of vaporizers	2	3	2
Number of gases	2 or 3	2, 3, or 4	2 or 3
Optional gases (Heliox and CO ₂ are cylinder only)	Air or Heliox; CO ₂	Air, Heliox, CO ₂ (up to two)	Air or Heliox; CO ₂
Breathing system and ventilator display mounting	Left or right side	Left or right side	Left or right side
Total number of cylinders (maximum 2 per gas)	Up to 4	Up to 5	Up to 2

Ventilators and monitors

The system uses a microprocessor-controlled ventilator with internal monitors, electronic PEEP, multiple modes of ventilation, and a pressure waveform display. Built-in connectors and communication software permit optional cardiovascular and respiratory gas monitoring.

Aestiva

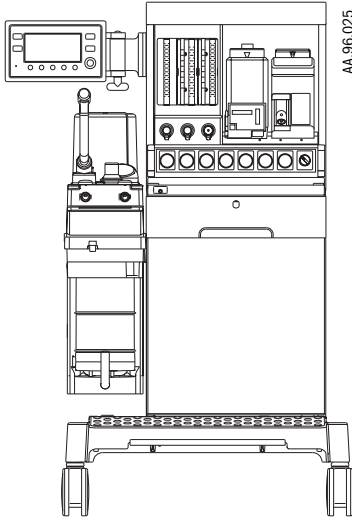

Two vaporizer positions, left-hand configuration with basic display mount.

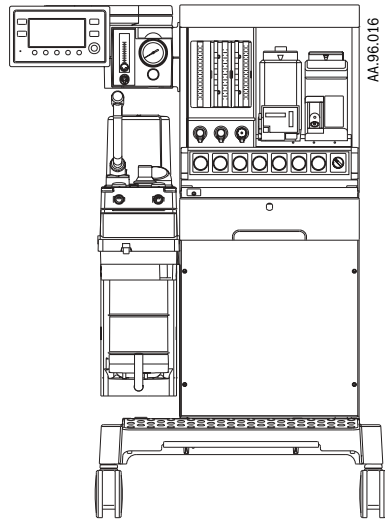

Two vaporizer positions, left-hand configuration with arm display mount.

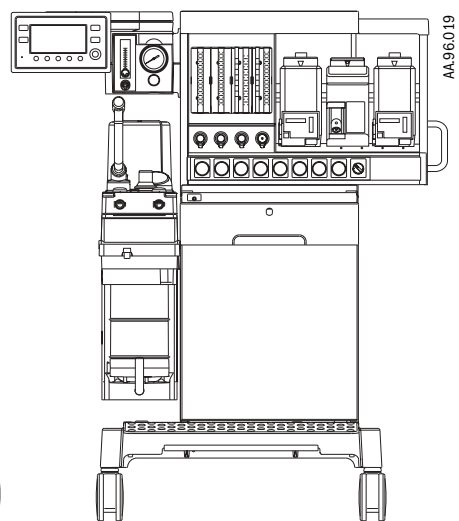

Three vaporizer positions, left-hand configuration with arm display mount.

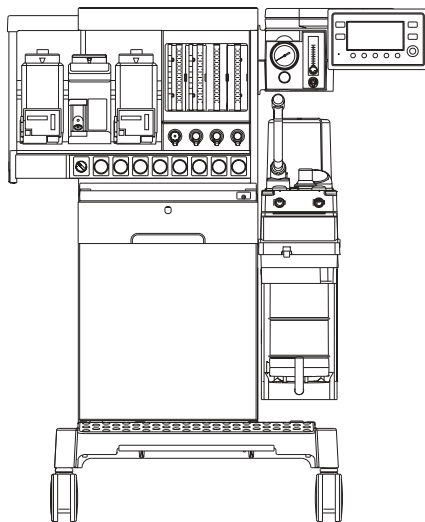

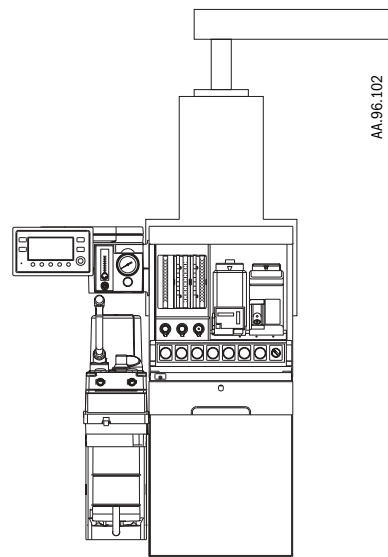

Three vaporizer positions, right-hand configuration with arm display mount.



Pendant with arm display mount.

Figure 1-1 • Aestiva systems























Symbols used in the manual or on the equipment

 Warnings and  Cautions tell you about dangerous conditions that can occur if you do not follow all instructions in this manual.

Warnings tell about a condition that can cause injury to the operator or the patient.

Cautions tell about a condition that can cause damage to the equipment. Read and follow all warnings and cautions.

Other symbols replace words on the equipment or in Datex-Ohmeda manuals. No one device or manual uses all of the symbols. These symbols include:

	On (power)		Not autoclavable
	Off (power)		Type B equipment
	Standby		Type BF equipment
	Standby or preparatory state for part of the equipment		Type CF equipment
	“ON” only for part of the equipment		Caution, ISO 7000-0434
	“OFF” only for part of the equipment		Attention, refer to product instructions, IEC 601-1
	Direct current		This way up
	Alternating current		Dangerous Voltage
	Protective earth ground		Earth ground
	Electrical input		Electrical output
	Pneumatic inlet		Pneumatic outlet

 Frame or chassis ground

 Alarm silence button

 Equipotential

 Variability

 Variability in steps

 Plus, positive polarity

 Minus, negative polarity

 Lamp, lighting, illumination

 Movement in one direction

 Movement in two directions

 Lock

 Unlock

REF Stock Number

SN Serial Number



Systems with this mark agree with the European Council Directive (93/42/EEC) for Medical Devices when they are used as specified in their Operation and Maintenance Manuals. The xxx is the certification number of the Notified Body used by Datex-Ohmeda's Quality Systems.

 Read top of float



Vacuum inlet



Suction bottle outlet

O₂+ O₂ Flush button



Cylinder



Isolation transformer



Linkage system



Risk of Explosion



Low pressure leak test

134° C Autoclavable

R Bag position/ manual ventilation

u Open drain (remove liquid)

q Inspiratory flow

t O₂ sensor connection

r Mechanical ventilation

U Close drain

Q Expiratory flow

 End case



The primary regulator is set to pressure less than 345 kPa.



The primary regulator is set to pressure less than 414 kPa.



CE European Union Representative

Aestiva

2 System Controls and Menus

In this section	Anesthesia system controls	2-2
	Breathing system controls	2-5
	Vaporizer controls	2-9
	Ventilator controls	2-11
	Optional flowmeter and suction regulators	2-19
	Optional CO ₂ Bypass mode operation	2-21

Anesthesia system controls

⚠ WARNING Explosion Hazard. Do not use Aestiva systems with flammable anesthetic agents.

⚠ WARNING Do not use antistatic breathing tubes or masks. They can cause burns if you use them near high frequency surgical equipment.

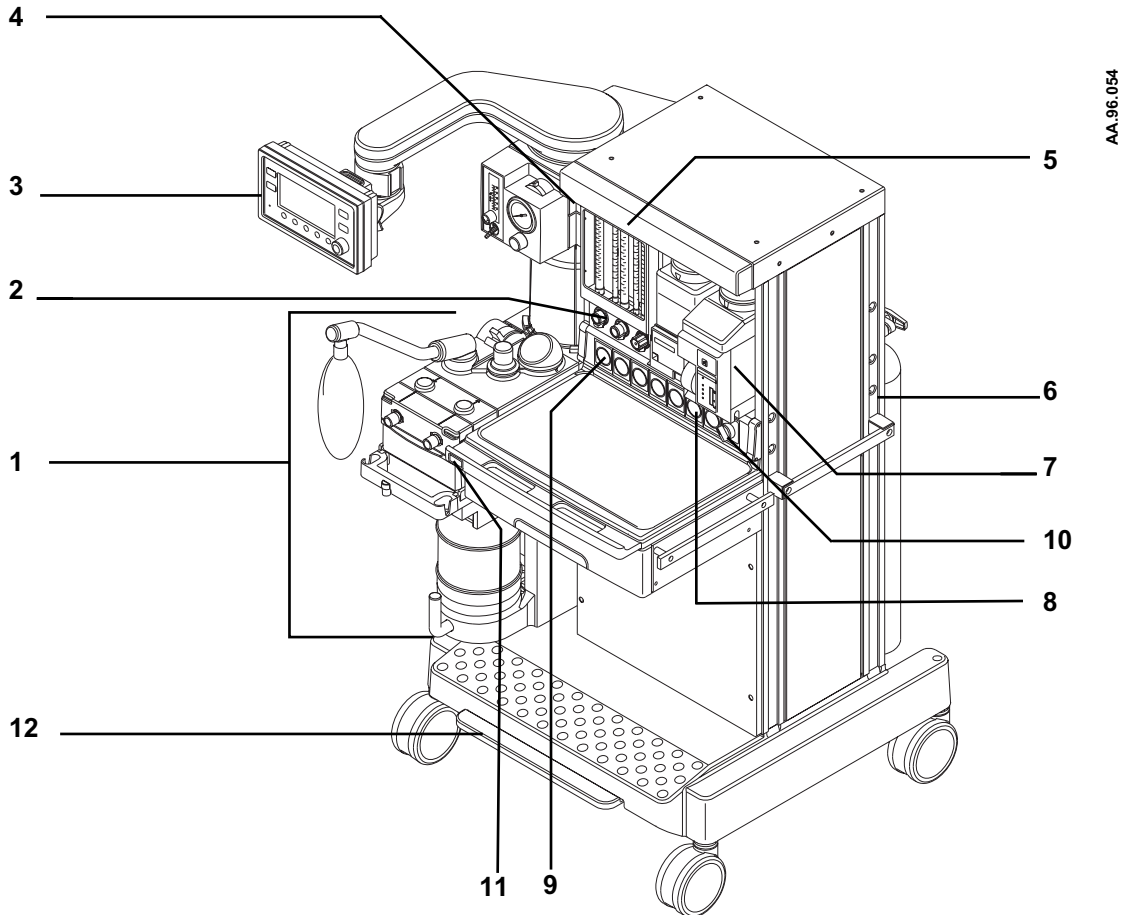

1. Breathing system (Figure 2-3)
2. Flow controls
3. Ventilator/monitoring display (Figure 2-5)
4. Light switch and Gooseneck lamp connector (some models)
5. Light (some models)
6. Dovetail rails
7. Vaporizers (Figure 2-4)
8. Gauge (cylinder pressure)
9. Gauge (pipeline pressure)
10. System switch
11. Flush button
12. Brake

Figure 2-1 ■ Aestiva (front view)

Figure 2-1 shows these controls on the front of the Aestiva.

Item	Description
System switch	Set the switch to on to permit gas flow and to turn on the monitoring.
<div data-bbox="943 499 1279 695"> </div>	
AA.96.103	
Flow controls	Turn the control counterclockwise to increase the flow and clockwise to decrease. The system switch must be on.
<div data-bbox="878 846 1338 999"> </div>	
AA.96.105	
O ₂ flush	Push O ₂ Flush to supply high flows of O ₂ to the breathing system.
<div data-bbox="959 1161 1224 1276"> </div>	
AA.96.106	
Light switch	Turns the light on and off.
<div data-bbox="902 1360 1312 1486"> </div>	
AA.96.107	
Brake	Push down to lock. Lift to release.
<div data-bbox="906 1612 1305 1749"> </div>	
AA.96.100	

The circuit breakers are on the rear panel of the Aestiva.

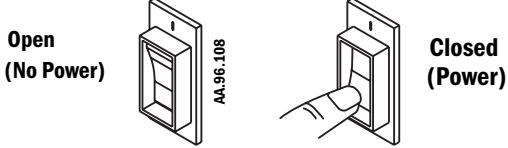
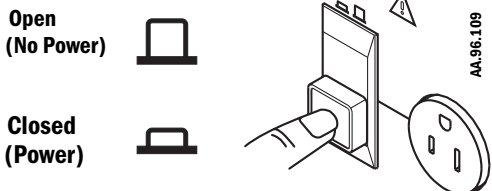
Item	Description (Figure 2-2)
Circuit Breakers	System circuit breaker
	
	Outlet circuit breakers
	

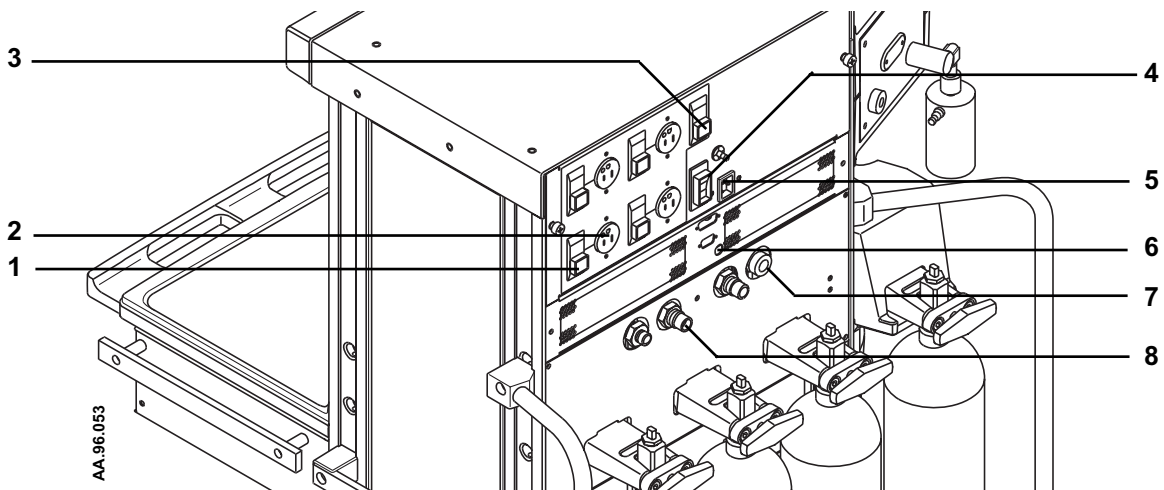

1. Circuit Breaker for Electrical Outlet
2. Electrical Outlet
3. Circuit Breaker for Total Outlet Current
4. Circuit Breaker for Mains Inlet
5. Mains Inlet
6. Ventilator fuse
7. Pneumatic Outlet
8. Pipeline Connection

Figure 2-2 ▪ Aestiva rear view

Breathing system controls

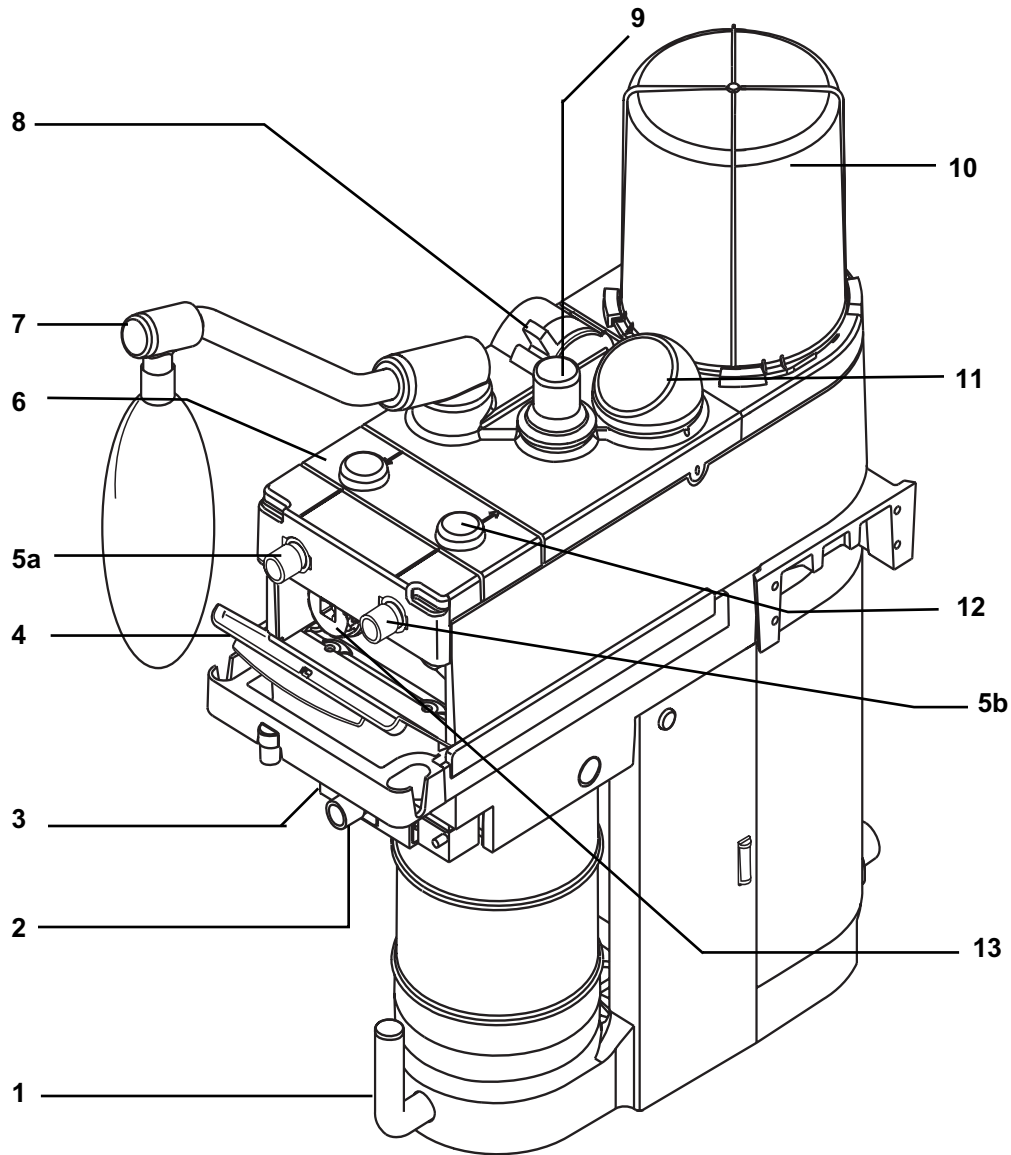

AB.23.003

1. Canister release
2. Auxiliary common gas outlet (optional)
3. Outlet switch (Auxiliary Common Gas Outlet)
4. Door
5. Flow sensor / patient connection (circuit connections)
 - a. Inspiratory (Circle circuit module) or to-fro connection (Mapleson/Bain circuit module)
 - b. Expiratory (Circle circuit module) or fresh gas connection (Mapleson/Bain circuit module)
6. Breathing circuit module (Circle)
7. Bag arm
8. Bag/Vent switch
9. APL valve
10. Bellows
11. Pressure gauge
12. Check valves
13. O₂ sensor

Figure 2-3 • Breathing system parts

Item	Description
Bag/Vent switch	When you first turn on the system, mechanical ventilation is always off. To start mechanical ventilation, move the switch from Bag to Vent.

Mechanical ventilation On (gas to bellows)

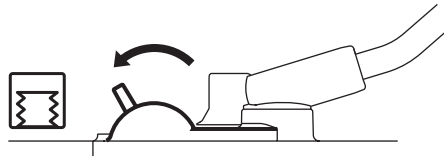

AB.23.059

Mechanical ventilation Off (gas to bag arm)

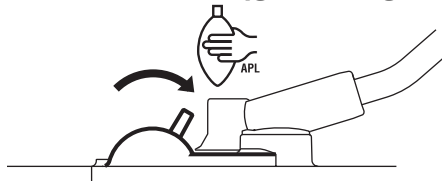

AB.23.060

APL valve	Limits breathing system pressure during manual ventilation. The scale shows approximate pressures. Above 30 cmH ₂ O, you will feel clicks as the knob turns.
-----------	---

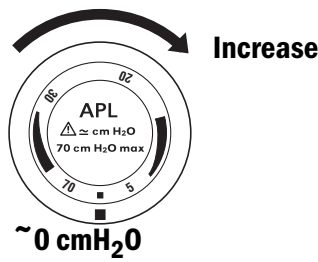

AB.23.064

Bag arm	One arm is adjustable (push in and turn). The other is not.
---------	---

Adjustable

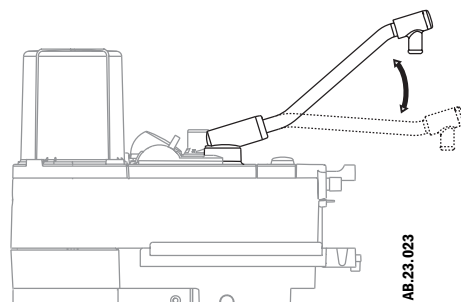

AB.23.023

Not adjustable

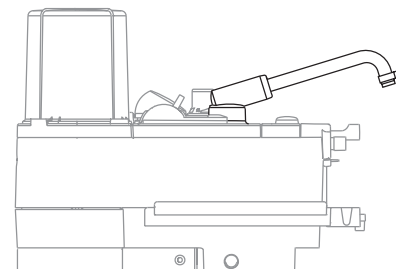

AB.23.024

Item	Description
Canister release	Open to replace soda lime or remove the canisters. Note, this also opens the breathing system.

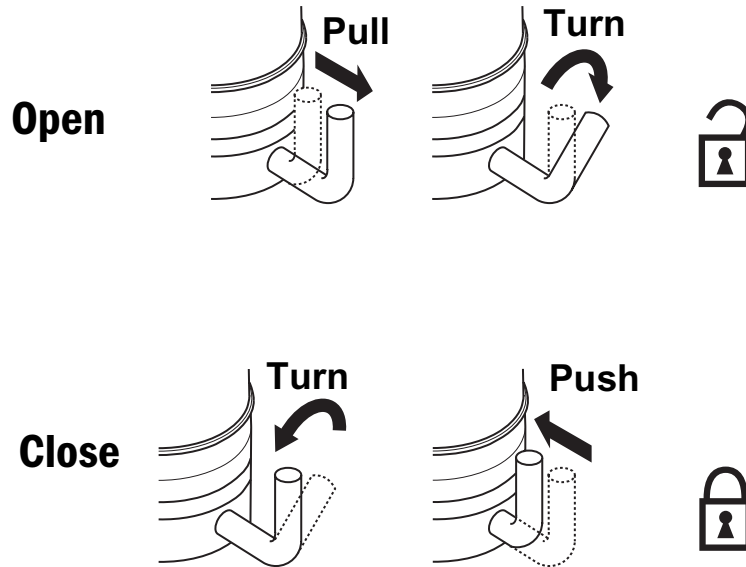

AB.23.061

CO₂ bypass (optional) Pulling and turning the canister release opens the canisters and activates the CO₂ bypass mode. The CO₂ bypass seals the breathing circuit when the canisters are open. This permits continued ventilation and rebreathing of exhaled gases.

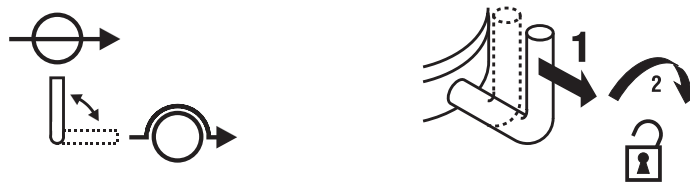

AB.23.179

Drain plug Unscrew the plug to remove condensate.

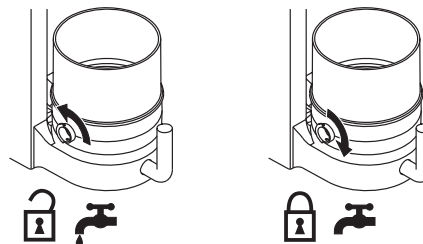

AB.23.062

Item	Description
Outlet switch (optional)	Sends fresh gas to the selected outlet when the system has an auxiliary common gas outlet. Monitoring and ventilation turn off when the auxiliary outlet is selected.

Breathing system selected

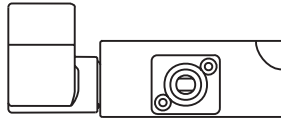

Auxiliary outlet selected

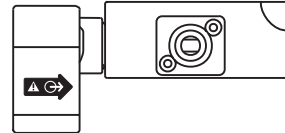

AB.23.063

Vaporizer controls

Refer to the description in this section and the vaporizer operation and maintenance manual for more detailed information on the vaporizer.

Figure 2-4 shows these controls.

Item	Description
Lock lever	Turn the lever fully clockwise to lock the vaporizer in position.
Concentration control and release	Push the release and turn the concentration control to set the agent concentration. The Tec 6 concentration control does not turn as long as the warm-up indicator is on.
Alarm Silence Switch (Tec 6 only)	Push to silence alarms. Hold for four seconds to start the speaker and light all indicators (alarm test).

Item	Description
Indicators (Tec 6 only)	All indicators come on at the start. The warm-up indicator goes off after approximately ten minutes when the operational indicator comes on. Other indicators come on during malfunctions.

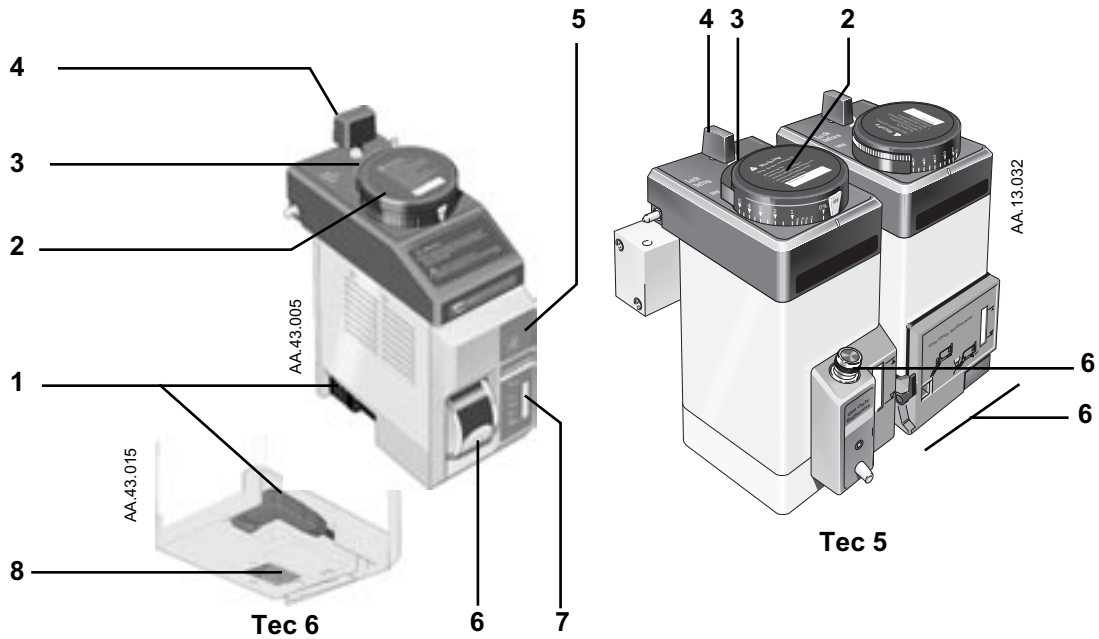

1. Power Cable (Only the Tec 6 Vaporizer)
2. Concentration Control
3. Concentration Control Release
4. Lock lever
5. Alarm Silence Switch (Tec 6 only)
6. Filler Port Controls
7. Indicators (Tec 6 only)
8. Battery Cover (Tec 6 only)

Figure 2-4 • Vaporizer controls

Ventilator controls

Optional Features The Aestiva 7900 can be equipped with several optional ventilation functions. References made in this manual to Heliox mode, and SIMV and PSVPro modes, are only applicable to systems equipped with these functions.

Control panel Ventilator controls include:

- Touch keys
- Menu screens
- A control knob

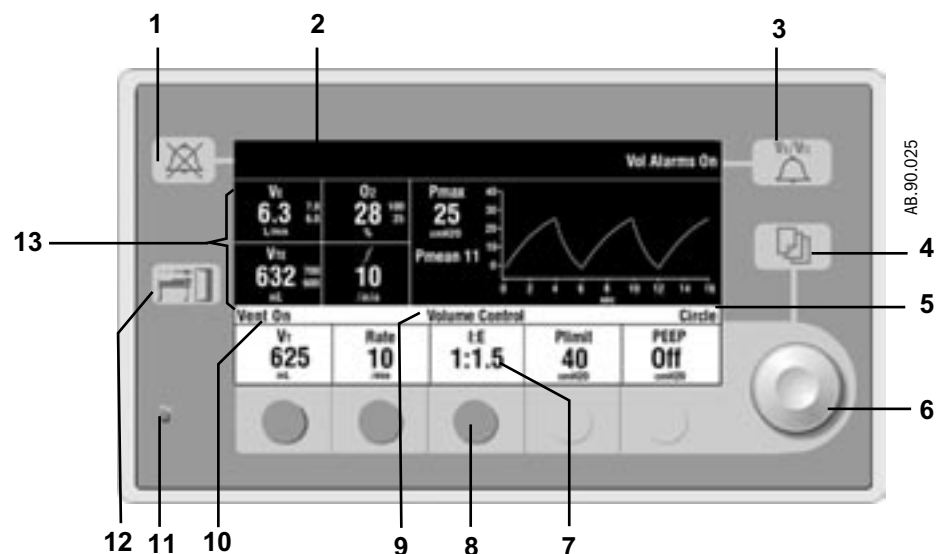

1. Alarm silence (key)
2. Alarm message (display)
3. Volume alarms On/Off (key)
4. Menu key
5. Breathing circuit module (display)
6. Control knob
7. Control setting
8. Selection key
9. Ventilation mode (display)
10. Ventilator status (On or Off)
11. Mains indicator
12. End Case (key)
13. Measured values

Figure 2-5 ▪ SmartVent controls and monitored data

All but two of the controls for the ventilator are located on the Ventilation/Monitoring display. The two controls are:

- The system switch, which powers the ventilator.
- The Bag/Vent switch, which starts and stops mechanical ventilation.

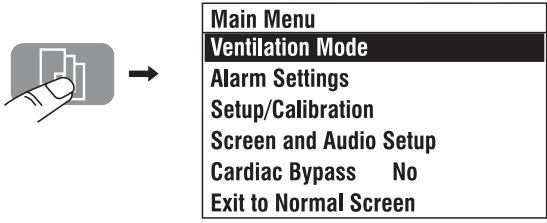
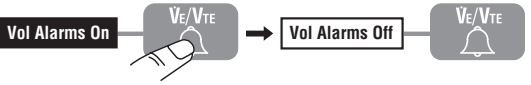
Item	Description
Menu key	Shows the main menu. <div data-bbox="844 640 1388 861">  </div>
Alarm silence key and indicator	<p>Silences most alarms for 120 seconds.</p> <p>Pushing the key when no alarm is active pre-silences low and medium priority alarms, except Minimum Monitoring, for 90 seconds.</p> <p>The "No O2 Pressure" alarm cannot be silenced.</p>
Volume alarm key and status	<p>Turns volume alarms on and off.</p> <div data-bbox="852 1386 1380 1470">  </div>

AB.90.036

AB.29.004

Item	Description
End Case key	<p>End Case helps to prevent false alarms when no patient is connected. It:</p> <ul style="list-style-type: none"> ▪ Puts the apnea and volume alarms into Standby. ▪ Returns user selections to the most common settings: Cardiac bypass off; Alarm limits shown; and Heliox mode off. ▪ Sets the PEEP to 0 cmH₂O (default value). ▪ Sets Plimit to one of two values: facility default or 40 cmH₂O. ▪ Forces the circuit Leak Audio to On. <p>Mechanical ventilation must be off (set the Bag/Vent switch to Bag or select the auxiliary common gas outlet).</p> <div style="display: flex; align-items: center; justify-content: center;">  <div style="margin-left: 10px;"> <p style="writing-mode: vertical-rl; transform: rotate(180deg);">AB.29.006</p> </div> </div>

How to set controls

The bottom of the screen shows control settings.

Notes:

- The ventilator will not allow the setting of values it cannot supply. A reject tone will sound or a message will appear on the screen.
- If the incorrect key is pushed, wait ten seconds or push the correct key.
- If the new setting is not saved, the ventilator continues to use the old setting.

Step 1

Push the selection key below the setting.

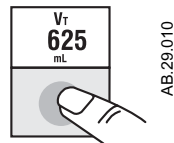

Step 2

Turn the knob to change the setting.

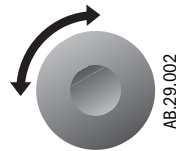

Step 3

Push the knob or the key to save the change.

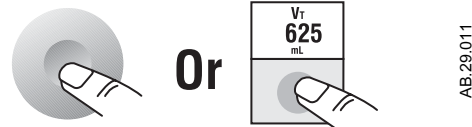

How to use the menu

Screens go back to the normal display 25 seconds after the last action.

During a calibration or other procedure, the screen shows the instructions.

Step 1

Push the Menu key to see the main menu.

AB29.013

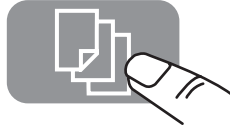

Step 2

Turn the knob to select an option (highlight).

AB.90.036

Main Menu
Ventilation Mode
Alarm Settings
Setup/Calibration
Screen and Audio Setup
Cardiac Bypass No
Exit to Normal Screen

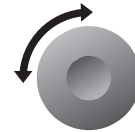

Step 3

Push the knob to show the next screen.

AB90.037

Main Menu
Ventilation Mode
Alarm Settings
Setup/Calibration
Screen and Audio Setup
Cardiac Bypass No
Exit to Normal Screen



AB.90.045

Setup/Calibration
SIMV/PSVPro Setup
O ₂ Sensor Cal
Inspiratory Pause Off
Heliox Mode Off
About Ventilator ...
Go to Main Menu

Menu map



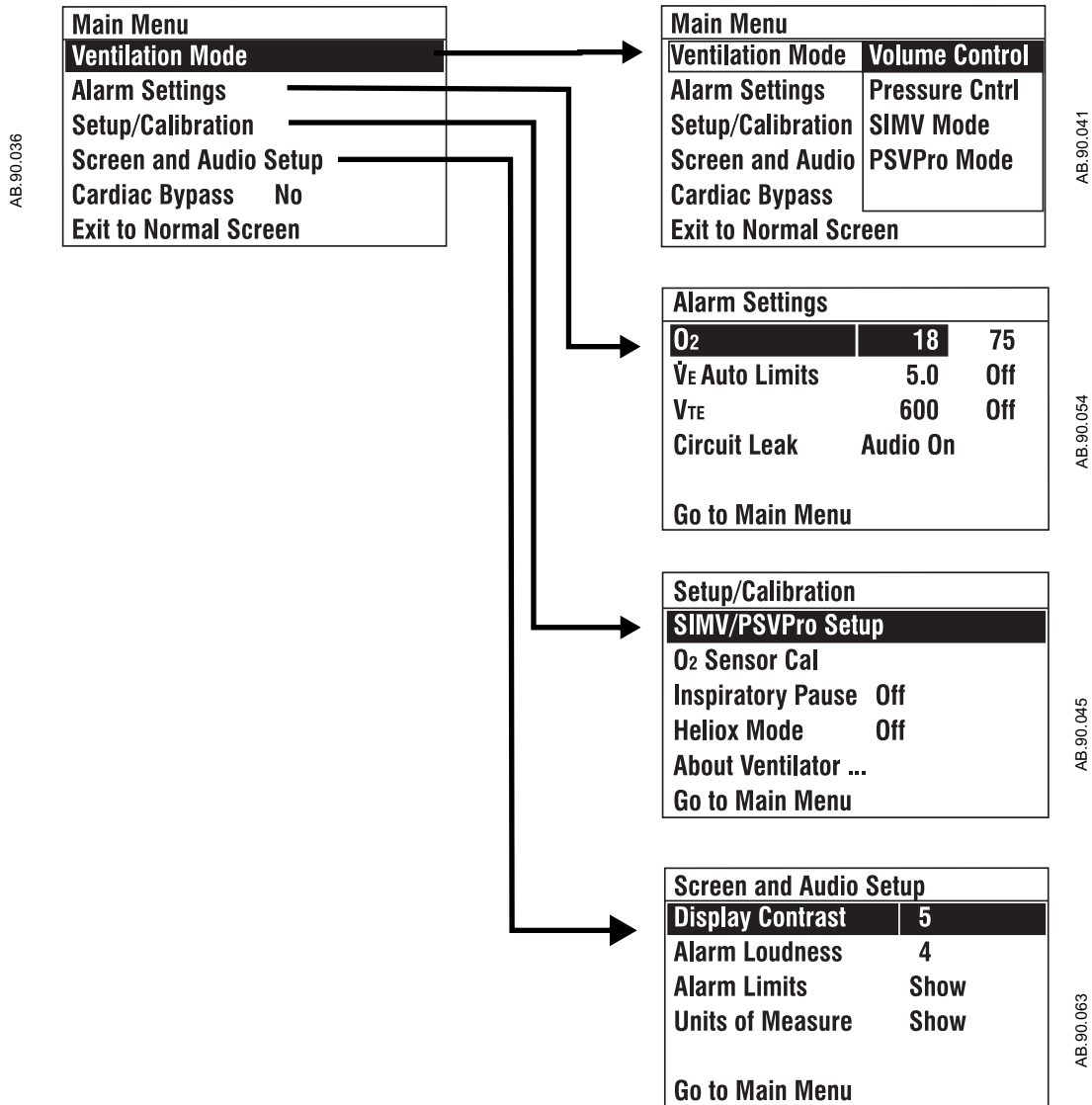

Figure 2-6 shows the menu map. The table tells you about some of the options.



Note: If the Alarm Settings page shows V_E Auto Limits during mechanical ventilation, the system automatically calculates alarm limits.

Figure 2-6 • Menu map

More about menu functions

Menu	Option	Function
Main	Cardiac Bypass (In Progress/No)	Turns off volume and apnea alarms when these are not appropriate (e.g., during heart lung bypass).
Alarm Settings	Circuit Leak (Audio On/Off)	Turns off the alarm tone for circuit leaks. You must set the low \dot{V}_E alarm first. Select Audio off if the circuit has a known leak (e.g., an uncuffed endotracheal tube).
Setup/ Calibration	SIMV/PSVPro Setup	Shows additional ventilation settings for SIMV and PSVPro modes.
	O ₂ Sensor Cal	Shows menu for O ₂ sensor calibration.
	Inspiratory Pause	Adds an inspiratory pause time to volume control breaths.
	Heliox mode (On/Off)	Tells the ventilator if heliox is in use.
	About Ventilator...	Shows service level settings: software version; if facility defaults or the control settings from the previous case are used when the system is first turned on; altitude; and drive gas (O ₂ or Air).
Screen and Audio	Alarm Limits (Show/Hide)	<p>'Show' displays alarm limits next to the data on the screen.</p> <div style="display: flex; justify-content: space-around; align-items: center;"> <div style="text-align: center;">  <p>Show Limits</p> </div> <div style="text-align: center;">  <p>Hide Limits</p> </div> </div>
	Units of Measure (Show/Hide)	<p>'Show' displays units under the data on the screen.</p> <div style="display: flex; justify-content: space-around; align-items: center;"> <div style="text-align: center;">  <p>Show Units</p> </div> <div style="text-align: center;">  <p>Hide Units</p> </div> </div>

How to change menu settings

This example changes alarm limits.

The screen goes back to the normal display 25 seconds after the last action.

Step 1

Select the desired menu.



AB.90.038

Main Menu
Ventilation Mode
Alarm Settings
Setup/Calibration
Screen and Audio Setup
Cardiac Bypass No
Exit to Normal Screen

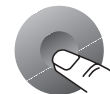
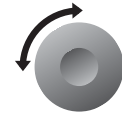

Step 2

Turn, then push the knob to select an option.

AB.90.054

Alarm Settings		
O₂	18	75
\dot{V}_E Auto Limits	5.0	Off
V _{TE}	600	Off
Circuit Leak	Audio On	
Go to Main Menu		

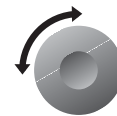

AB.90.055

Alarm Settings		
O₂	18	75
\dot{V}_E Auto Limits	5.0	Off
V _{TE}	600	Off
Circuit Leak	Audio On	
Go to Main Menu		



Step 3

Turn the knob to change the setting.

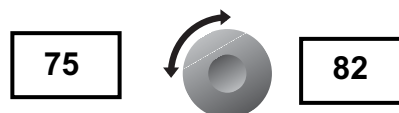

Step 4

Push the knob to save the change.



Optional flowmeter and suction regulators

These options are available:

- An external O₂ flowmeter
- Continuous suction regulators (3 Mode models)
- A venturi suction regulator (2 Mode models)

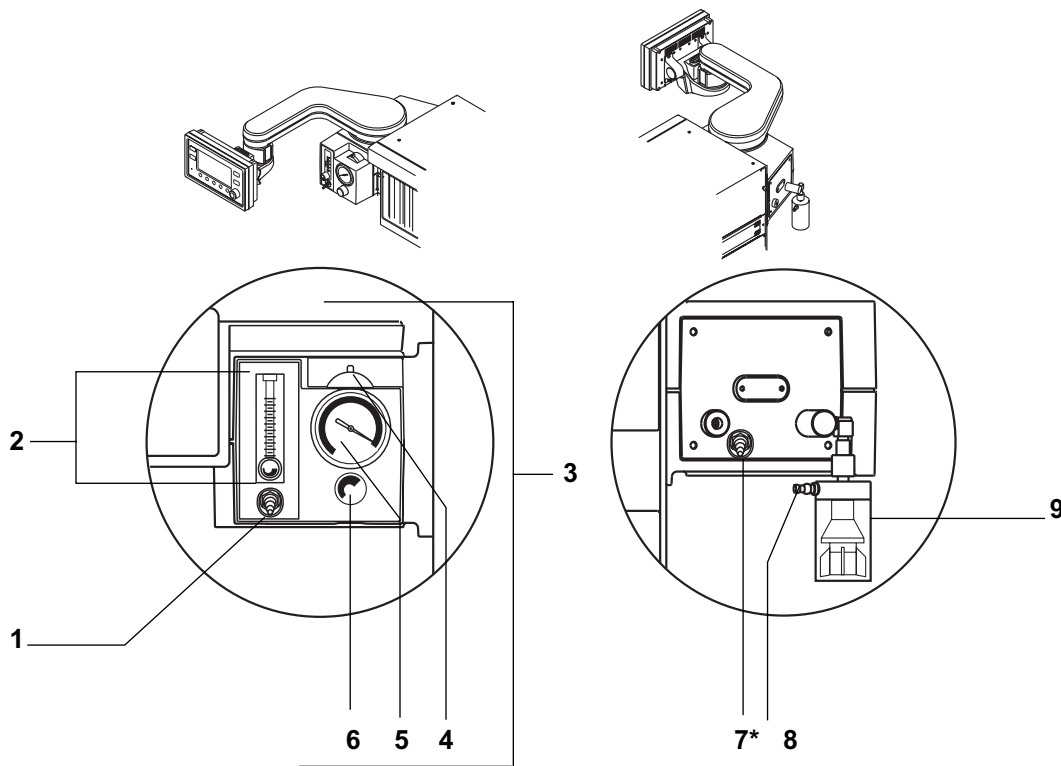

* Only non-venturi regulators have this connection.
Venturi regulators generate vacuum from system gas supplies.

1. Flowmeter outlet
2. External O₂ flowmeter
3. Suction regulator
4. Suction mode switch (On/Off/MAX)
5. Vacuum gauge
6. Suction adjustment
7. Vacuum inlet (non-venturi models only)
8. Collection bottle connection
9. Overflow safety trap

Figure 2-7 ▪ Controls and connectors for flowmeters and suction regulator

AA.96.168

Suction regulator controls

Item	Description
------	-------------

Mode switch:

With a continuous suction regulator (3 Modes):

- MAX: for maximum suction, set the switch to MAX.
- On (|): for adjustable suction, set the switch to On (|) or I.
- Off (O): to turn Off suction, set the switch to O.

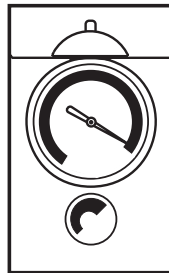

AA.96.169

With a venturi regulator (2 Modes):

- On (|): for adjustable suction, set the switch to On (|) or I.
- Off (O): to turn Off suction, set the switch to O.

With the mode switch set to "I", turn the control clockwise to increase suction and counterclockwise to decrease it.



AA.96.170

Increase



Decrease



External flowmeter controls

Turn the control counterclockwise to increase the O₂ flow and clockwise to decrease.

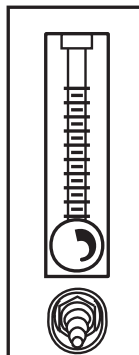

AA.96.171

Increase



Decrease



Optional CO₂ Bypass mode operation

Pulling and turning the canister release opens the canisters and activates the optional CO₂ bypass mode. The CO₂ bypass seals the breathing circuit when the canisters are open. This permits continued ventilation and rebreathing of exhaled gases.

When the canisters are open, the medium priority alarm message “No CO₂ Absorption” is displayed. The alarm is downgraded to low priority after silencing.

Close the absorber canisters to activate the Absorber mode. Closing the canisters directs exhaled gas flow through the absorber, removing CO₂. Do the breathing system tests as soon as possible after returning to Absorber mode.

When operating in CO₂ Bypass mode, water condensate may collect in the bypass assembly. The water drains automatically when the canisters are closed.

Datex-Ohmeda strongly recommends using CO₂ monitoring when using the CO₂ Bypass device.

Systems which have the optional CO₂ Bypass mode installed have the following label at the canister release.



Aestiva

3 Operation and Tutorial

⚠ WARNING In addition to volume apnea and low airway pressure alarms, other ventilator alarms are included to indicate potential hazard conditions. All alarms that occur should be investigated to ensure adequate patient safety.

In this section This section describes specific tasks. Use it as a step-by-step guide or a training tool.

Turn On the system	3-2
Set the alarm loudness	3-3
Show or hide alarm limits and units	3-5
Adjust patient data for Heliox	3-7
Turn the volume alarms on or off	3-8
Set alarm limits.	3-9
Set an audible alarm for circuit leaks	3-11
Set Cardiac Bypass	3-12
Start mechanical ventilation	3-14
Stop mechanical ventilation	3-15
Set the ventilation mode	3-16
Set ventilator controls	3-18
Set SIMV and PSVPro controls.	3-24
Silence alarms	3-26
Reading the pressure waveform (Paw)	3-27
Measure circuit compliance.	3-30
Show the service settings.	3-31
Optional Passive AGSS operation	3-33
Optional Active AGSS operation	3-34

Turn On the system

Step 1

Connect the power cord to a wall outlet. The mains indicator comes on when AC Power is connected.

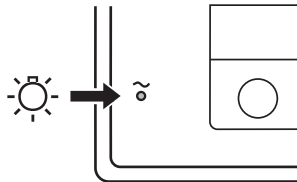

AB.29.007

Step 2

Set the system switch to On (I).



AA.96.104

Step 3

The display shows the power-up screen, and the system does a series of self tests.

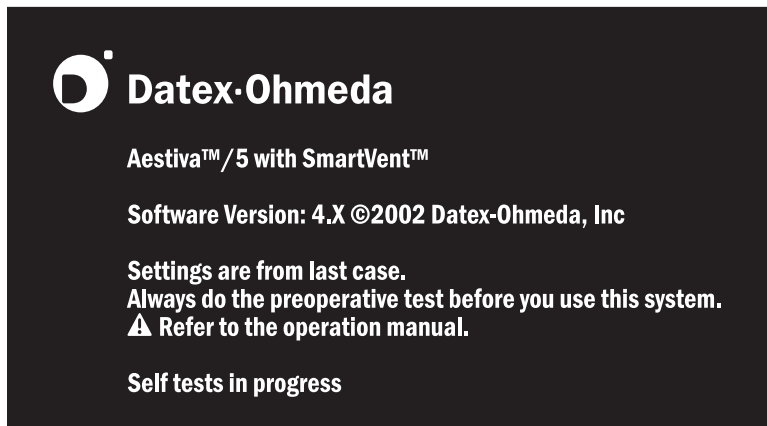

AB.90.018

Step 4

When the self tests pass, the display shows the normal screen.

If a test fails, the screen shows an alarm. Refer to the troubleshooting section.

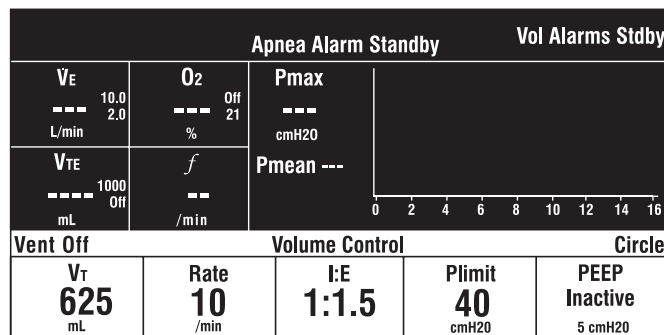

AB.90.021

Set the alarm loudness

Step 1

Select the Screen and Audio Setup menu.

- Push the menu key.
- Turn, then push the knob to select Screen and Audio.

AB.29.013



AB.90.036

Main Menu	
Ventilation Mode	
Alarm Settings	
Setup/Calibration	
Screen and Audio Setup	
Cardiac Bypass	No
Exit to Normal Screen	

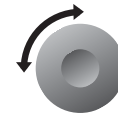

AB.90.039

Main Menu	
Ventilation Mode	
Alarm Settings	
Setup/Calibration	
Screen and Audio Setup	
Cardiac Bypass	No
Exit to Normal Screen	



Step 2

Turn, then push the knob to select alarm loudness.

AB.90.063

Screen and Audio Setup	
Display Contrast	5
Alarm Loudness	4
Alarm Limits	Show
Units of Measure	Show
Go to Main Menu	

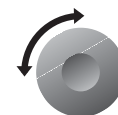

AB.90.043

Screen and Audio Setup	
Display Contrast	5
Alarm Loudness	4
Alarm Limits	Show
Units of Measure	Show
Go to Main Menu	

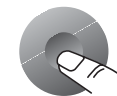

Step 3

Turn, then push the knob to adjust the volume.

- The volume range is 1 to 5 (loudest).
- As the volume is changed, the system sounds test tones.
- Push the knob to save the change.

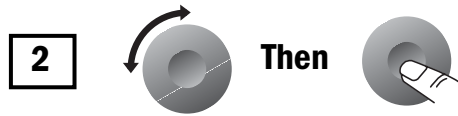

Show or hide alarm limits and units

To simplify the displays, hide alarm limits and units of measurement. If the alarm limits are hidden, the screen automatically shows the limits when:

- An alarm occurs.
- Volume alarms are off or the auxiliary common gas outlet is selected (monitoring off).
- An individual alarm limit is set to Off.

When the system is set to Standby, alarm limits go back to Show.

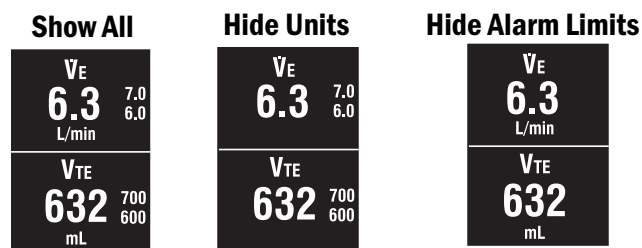

AB.90.033

Step 1

Select the Screen and Audio Setup menu.

- Push the menu key.
- Turn, then push the knob to select Screen and Audio Setup.



AB90.036

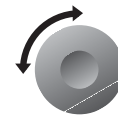
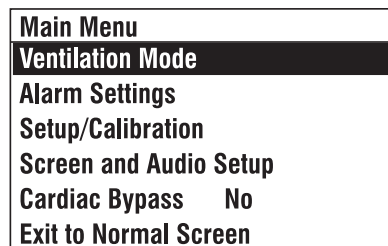

AB90.039

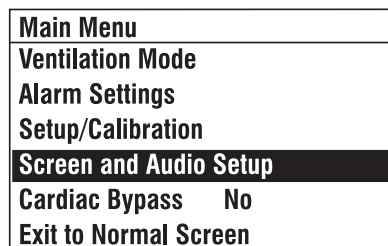

Step 2

Turn, then push the knob to select Alarm Limits or Units of Measure.

AB90.063

Screen and Audio Setup	
Display Contrast	5
Alarm Loudness	4
Alarm Limits	Show
Units of Measure	Show
Go to Main Menu	

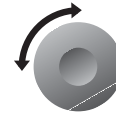

AB90.044

Screen and Audio Setup	
Display Contrast	5
Alarm Loudness	4
Alarm Limits	Show
Units of Measure	Show
Go to Main Menu	

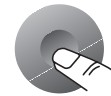

Step 3

Turn, then push the knob to select Show or Hide. Push the knob to save the change.

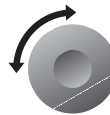
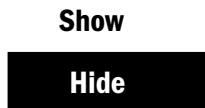

Then



Adjust patient data for Heliox

The Aestiva 7900 can be equipped with several optional ventilation functions. References made in this manual to Heliox mode, and SIMV and PSVPro modes, are only applicable to systems equipped with these functions.

When the Heliox mode is selected, the system automatically corrects measurements for the lower density of Heliox (compared to air).

WARNING

The Heliox mode must be set correctly for accurate volume monitoring and delivery.

Step 1

Select the Setup/Calibration menu.

- Push the menu key.
- Turn, then push the knob to select Setup/Calibration.

AB.29.013



AB.90.036

Main Menu
Ventilation Mode
Alarm Settings
Setup/Calibration
Screen and Audio Setup
Cardiac Bypass No
Exit to Normal Screen

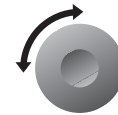

AB.90.037

Main Menu
Ventilation Mode
Alarm Settings
Setup/Calibration
Screen and Audio Setup
Cardiac Bypass No
Exit to Normal Screen



Step 2

Turn, then push the knob to select Heliox Mode.

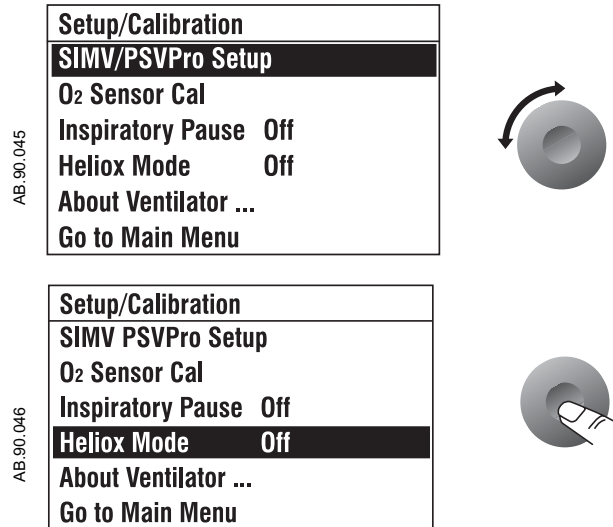

Step 3

Turn, then push the knob to select on or off. You must push the knob to save the change

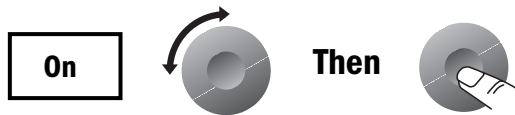

Turn the volume alarms on or off

WARNING

Do not turn volume alarms off with a spontaneously breathing patient, the system will not alarm for low volume.

The volume alarm key (\dot{V}_E/V_{TE}) turns volume alarms on and off. When the alarms are off, a large X covers the limits.

Use this control to prevent false alarms if you switch to manual ventilation at lower tidal volumes.



AB.29.014

Use the End Case key (on control panel) to prevent apnea alarms between patients.

Set alarm limits

Note: If the Alarm Settings page shows \dot{V}_E Auto Limits during mechanical ventilation, the system is set to automatically calculate \dot{V}_E limits.

Step 1

Select the Alarm Settings menu.

- Push the menu key.
- Turn, then push the knob to select Alarm Settings.

AB.29.013



AB.90.036

Main Menu	
Ventilation Mode	
Alarm Settings	
Setup/Calibration	
Screen and Audio Setup	
Cardiac Bypass	No
Exit to Normal Screen	

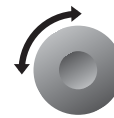

AB.90.038

Main Menu	
Ventilation Mode	
Alarm Settings	
Setup/Calibration	
Screen and Audio Setup	
Cardiac Bypass	No
Exit to Normal Screen	



Step 2

Turn, then push the knob to select a limit.

AB.90.054

Alarm Settings		
O₂	18	75
\dot{V}_E Auto Limits	5.0	Off
V _{TE}	600	Off
Circuit Leak	Audio On	
Go to Main Menu		

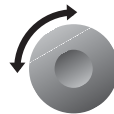

AB.90.055

Alarm Settings		
O₂	18	75
\dot{V}_E Auto Limits	5.0	Off
V _{TE}	600	Off
Circuit Leak	Audio On	
Go to Main Menu		



Step 3

Turn, then push the knob to change the limit.

- Push the knob to save the change.
- The screen returns to the normal display 25 seconds after the last change.



Set an audible alarm for circuit leaks

The patient circuit leak alarm is activated if less than half of the inspired volume returns through the expiratory flow sensor during mechanical ventilation. To prevent nuisance alarms from a known leak (e.g., an un-cuffed endotracheal tube), set the audio to Off. Normal volume and apnea monitoring does not change.

Note: This alarm is the first stage in detecting a circuit disconnect. The audible leak alarm cannot be turned off unless volume alarms are on, and the low \dot{V}_E limit is set to a value other than off.

Step 1

Select the Alarm Settings menu.

- Push the menu key.
- Turn, then push the knob to select Alarm Settings.

AB.29.013



AB.90.036

Main Menu
Ventilation Mode
Alarm Settings
Setup/Calibration
Screen and Audio Setup
Cardiac Bypass No
Exit to Normal Screen

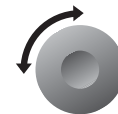

AB.90.038

Main Menu
Ventilation Mode
Alarm Settings
Setup/Calibration
Screen and Audio Setup
Cardiac Bypass No
Exit to Normal Screen



Step 2

Turn, then push the knob to select circuit leak audio.

AB.90.054

Alarm Settings		
O ₂	18	75
\dot{V}_E Auto Limits	5.0	Off
V _{TE}	600	Off
Circuit Leak	Audio On	
Go to Main Menu		

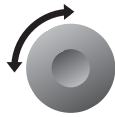

AB.90.056

Alarm Settings		
O ₂	18	75
\dot{V}_E Auto Limits	5.0	Off
V _{TE}	600	Off
Circuit Leak	Audio On	
Go to Main Menu		



Step 3

Turn, then push the knob to change the setting. You must push the knob to save the change.

Audio On

↻

Audio Off

➡

Then

➡



Set Cardiac Bypass

Set Cardiac Bypass to In Progress to prevent volume and apnea alarms when the patient is on cardio-pulmonary bypass.

When Cardiac Bypass In Progress is selected, the display shows:

- Cardiac Bypass
- Apnea Alarm Off
- Vol Alarms Off

Note: The mechanical ventilation must be off. When the mechanical ventilation is turned back on, Cardiac Bypass returns to the No Bypass setting and alarms become active.

Step 1

Select the Cardiac Bypass menu item:

- Push the menu key.
- Turn, then push the knob to select Cardiac Bypass In Progress.

AB.29.013



AB.90.036

Main Menu
Ventilation Mode
Alarm Settings
Setup/Calibration
Screen and Audio Setup
Cardiac Bypass No
Exit to Normal Screen

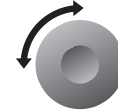

AB.90.040

Main Menu
Ventilation Mode
Alarm Settings
Setup/Calibration
Screen and Audio
Cardiac Bypass No
Exit to Normal Screen



AB.90.068

Main Menu
Ventilation Mode
Alarm Settings
Setup/Calibration
Screen and Audio
Cardiac Bypass In Progress
Exit to Normal Screen

Step 2

Push the knob again to return to No.



AB.90.040

Main Menu
Ventilation Mode
Alarm Settings
Setup/Calibration
Screen and Audio
Cardiac Bypass No
Exit to Normal Screen

Start mechanical ventilation

- ⚠ WARNING** Make sure the patient circuit is correctly assembled and the control settings are correct before you start or stop ventilation.

Mechanical ventilation is off when you first turn on the system.

Step 1

Make sure the control settings are OK.

OK?

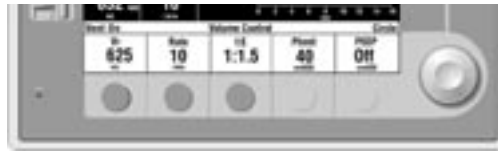

AB.90.025

Step 2

Turn off the auxiliary common gas outlet (some models).

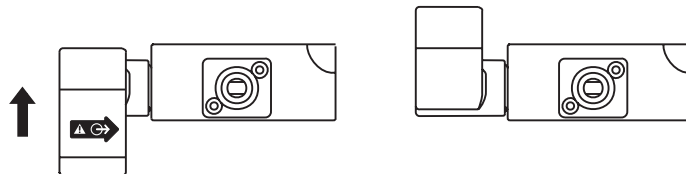

AB.23.065

Step 3

Set the Bag/Vent switch back to Vent.

- If mechanical ventilation is not available, a message tells you what to do. For example “To start mech vent set the Bag/Vent switch to Bag and back to Vent.”

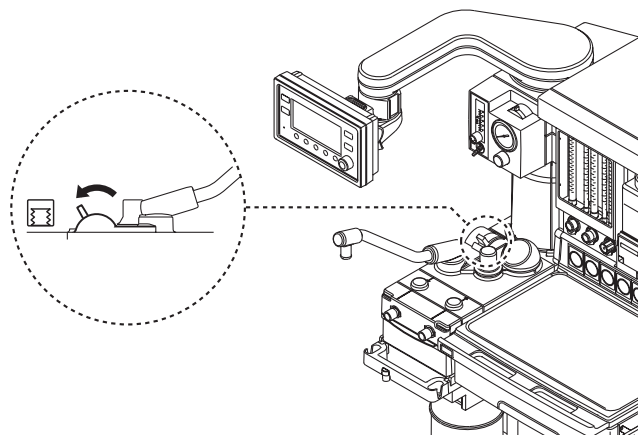

AA.96.110

Stop mechanical ventilation

⚠ WARNING Make sure the patient circuit is correctly assembled and the control settings are correct before you start or stop ventilation.

Step 1

Make sure control settings are OK.

OK?

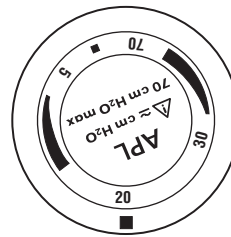

AB.23.066

Step 2

Set the Bag/Vent switch to Bag.

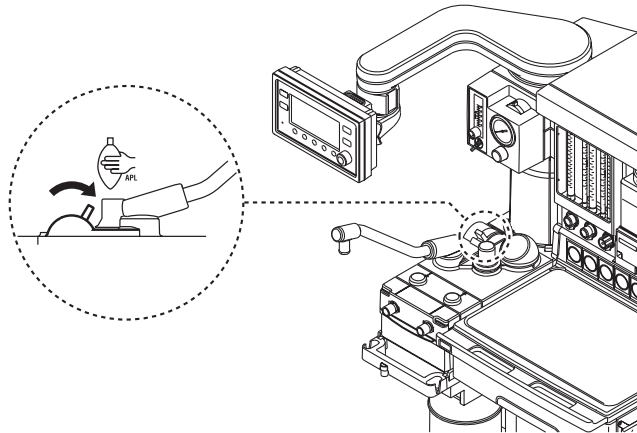

AA.96.111

Set the ventilation mode

Text below the waveform shows the ventilation mode:

- Pressure controlled modes supply a set pressure during inspiration.
- Volume controlled modes supply a set tidal volume.

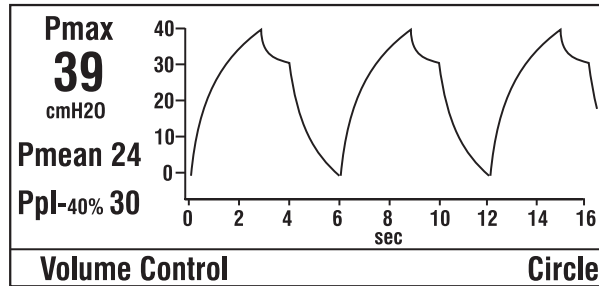

AB.90.092

Step 1

Select the Ventilation Mode.

- Push the menu key.
- Push the knob to select Ventilation Mode.

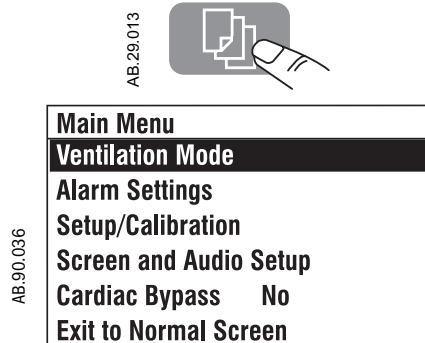

Step 2

Turn, then push the knob to change the mode. Push the knob to save the change.

Volume Control

Pressure Cntrl

SIMV Mode

PSVPro Mode



Note PSVPro is pressure supported ventilation with apnea backup.

Step 3

Set the highlighted control parameter. Each mode has one parameter that must be set (VT for Volume and SIMV, P_{inspired} for Pressure, and P_{support} for PSVPro).

- Turn, then push the knob to set the value.
- Until a value is set, the ventilator shows “---”. If any other key is pressed at this time, a tone will sound.

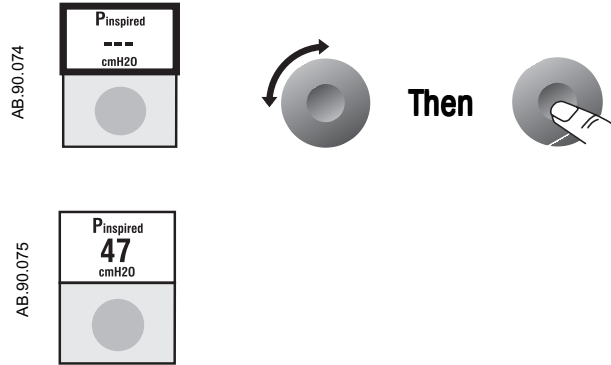

Set ventilator controls

Optional features

The Aestiva 7900 can be equipped with several optional ventilation functions. References made in this manual to Heliox mode, and SIMV and PSVPro modes, are only applicable to systems equipped with these functions.

The ventilator controls present are based on the ventilation mode.

Messages appear on the screen if:

- You try to set a value the system cannot supply.
- You change a setting but do not save it: "Push knob to confirm change Turn knob to change setting".

Step 1

Push the selection key.

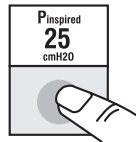

AB.90.076

Step 2

A tone sounds and a box flashes around the setting.



AB.90.077

Step 3

Turn the knob to set the value.



AB.90.078

Step 4

Push the knob to save the setting.

- A tone sounds.
- The flashing stops.



AB.90.079

Ventilator controls

Flow Trigger Level This parameter sets the minimum flow detected by the ventilator which triggers the ventilator to deliver a mechanical breath to a spontaneously breathing patient. Only active in SIMV and PSVPro modes.

I:E This control sets the inspiratory to expiratory ratio of mechanical breaths supplied to the patient.

Insp. Termination Level This parameter sets the percentage of the peak inspiratory flow where the ventilator stops a pressure supported breath. Only active in SIMV and PSVPro modes.

PEEP This control sets the positive end expiratory pressure. This is only available during mechanical ventilation, but the control can be set at any time.

 **WARNING** Do not use a separate mechanical PEEP valve; incorrect operation and patient injury can result.

Pinspired This control sets the amount of pressure delivered to the patient in each pressure controlled breath.

Plimit This control sets the maximum (and sustained) airway pressures tolerated in the patient's breathing system.

- If the high airway pressure limit is reached, inspiration stops and exhalation starts.
- The limit is an absolute value. There is no offset for PEEP pressure.

Note: Pmax is the peak sensed airway pressure; Plimit is the airway pressure limit set with front panel controls.

Psupport This control sets the delivered pressure during pressure support ventilation. Only active in SIMV and PSVPro modes.

Rate This control permits you to set the frequency of mechanical breaths delivered to the patient. It also establishes the apnea delay time in the PSVPro mode.

Tinspired This control sets the time in seconds for each timed inspiration. Only active in SIMV and PSVPro modes.

Trigger Window This control sets the range as a percent of the exhalation phase within which the patient may trigger the next mechanical breath. Only active in SIMV and PSVPro modes.

VT This control sets the tidal volume delivered to the patient in the Volume Control and SIMV modes.

Volume Control mode The figure and table below show Volume Control settings.

Vent On	Volume Control			Circle
V _T 625 mL	Rate 10 /min	I:E 1:1.5	Plimit 40 cmH ₂ O	PEEP Off cmH ₂ O

AB.90.025

Settings	VT	Rate	I:E	Plimit	PEEP
Range	20 - 1500	4 - 100	2:1 - 1:8	12 - 100	Off, 4 - 30
Increments	varies*	1 bpm	0.5	1 cmH ₂ O	1 cmH ₂ O

*Increments of 1 mL from 20 to 50, 5 mL from 50 to 100, 10 mL from 100 to 300, 25 mL from 300 to 1000, 50 mL from 1000 to 1500

Pressure Control mode The figure and table below show Pressure Control settings.

Vent On	Pressure Ctrl			Circle
Pinspired 34 cmH ₂ O	Rate 10 /min	I:E 1:1.5	Plimit 40 cmH ₂ O	PEEP Off cmH ₂ O

AB.90.064

Settings	Pinspired	Rate	I:E	Plimit	PEEP
Range	5 - 60	4 - 100	2:1 - 1:8	12 - 100	Off, 4 - 30
Increments	1 cmH ₂ O	1 bpm	0.5	1 cmH ₂ O	1 cmH ₂ O

SIMV mode The figure and table below show SIMV settings.

Vent On	SIMV Mode			Circle
V _T 625 mL	Rate 4 /min	Tinspired 1.5 sec	Psupport 10 cmH ₂ O	PEEP 5 cmH ₂ O

AB.90.071

Settings	VT	Rate	Tinspired	Psupport	PEEP
Range	20 -1500	2 - 60	0.2 - 5.0	Off, 2-40	Off, 4 - 30
Increments	varies*	1 bpm	0.1 s	1 cmH2O	1 cmH2O

*Increments of 1mL from 20 to 50, 5 mL from 50 to 100, 10 mL from 100 to 300, 25 mL from 300 to 1000, 50 mL from 1000 to 1500

PSVPro mode

PSVPro is pressure supported ventilation with apnea backup.

The figure below shows PSVPro settings. In this mode the Pinspired, Rate, and Tinspired parameters are not active, but they may be changed.

Vent On		PSVPro Mode			Circle
Pinspired 20 cmH2O	Rate 10 /min	Tinspired 1.5 sec	Psupport 10 cmH2O	PEEP 5 cmH2O	

AB.90.087

During backup ventilation, the ventilator will ventilate the patient using the SIMV-PC + PSV mode. All parameters shown are active in this mode.

Vent On		SIMV-PC + PSV			Circle
Pinspired 20 cmH2O	Rate 10 /min	Tinspired 1.5 sec	Psupport 10 cmH2O	PEEP 5 cmH2O	

AB.90.086

Settings	Pinspired	Rate	Tinspired	Psupport	PEEP
Range	5 - 60	2 - 60	0.2 - 5.0	Off, 2-40	Off, 4 - 30
Increments	1 cmH2O	1 bpm	0.1 s	1 cmH2O	1 cmH2O

Set inspiratory pause (volume modes)

You can only use inspiratory pause in Volume Control or SIMV modes. In pressure modes, Inspiratory Pause displays a message “No Pause Δ ”.

When Pause is on, the inspiratory volume stays in the patient’s lungs for the set pause time at the end of inspiration.

Pause can be set from Off to 60 percent of inspiratory time in increments of five percent. Minimum pause time is 400 ms.

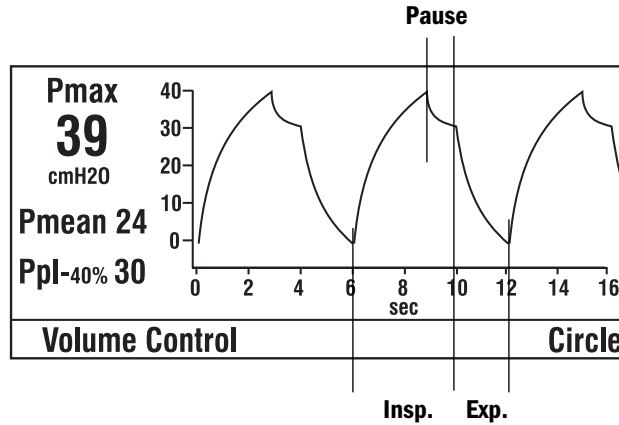

AB.90.092

Step 1

Select the Setup/Calibration menu.

- Push the menu key.
- Turn, then push the knob to select the Setup/Calibration menu.

AB.29.013



AB.90.036

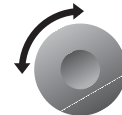
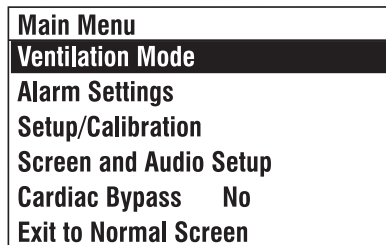

AB.90.037

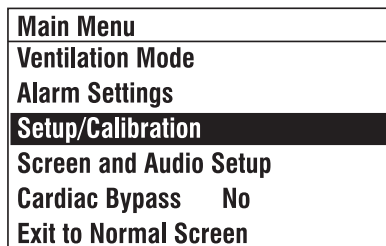

Step 2

Turn, then push the knob to select Inspiratory Pause.

AB.90.083

Setup/Calibration	
SIMV/PSVPro Setup	
O ₂ Sensor Cal	
Inspiratory Pause	40% of T_i
Heliox Mode	Off
About Ventilator ...	
Go to Main Menu	

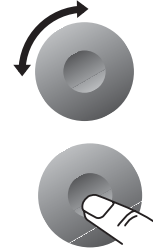

Step 3

Turn, then push the knob to change the setting. You must push the knob to save the change.

20% of T_i

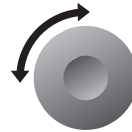

Then



Set SIMV and PSVPro controls

The SIMV and PSVPro modes allow the user to set additional ventilator controls. The Pinspired, Rate, Tinspired, Psupport and PEEP controls can be set using the selection keys. The Plimit, Trigger Window, Flow Trigger Level, and Inspiratory Termination Level may be set through the Setup/Calibration menu.

Step 1

Select the SIMV/PSVPro Setup menu.

- Push the menu key.
- Turn, then push the knob to select Setup/Calibration.

AB.29.013



AB.90.036

Main Menu
Ventilation Mode
Alarm Settings
Setup/Calibration
Screen and Audio Setup
Cardiac Bypass No
Exit to Normal Screen

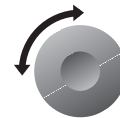

AB.90.037

Main Menu
Ventilation Mode
Alarm Settings
Setup/Calibration
Screen and Audio Setup
Cardiac Bypass No
Exit to Normal Screen



Step 2

Push the knob to select SIMV/PSVPro Setup.

AB.90.045

Setup/Calibration
SIMV/PSVPro Setup
O ₂ Sensor Cal
Inspiratory Pause Off
Heliox Mode Off
About Ventilator ...
Go to Main Menu



⚠ WARNING

Most anesthetic agents will cause patients to have reduced ventilatory responses to carbon dioxide and to hypoxemia. Therefore, triggered modes of ventilation may not produce adequate ventilation.

⚠ WARNING

The use of neuromuscular blocking agents will reduce the patient's breathing response, which will interfere with triggering.

Step 3

Turn, then push the knob to select a setting.

AB.90.073

SIMV/PSVPro Setup	
Plimit (cmH₂O)	40
Trigger Window (%)	20
Flow Trigger Level (L/min)	1.0
Insp. Termination Level (%)	25
Go to Setup/Calibration Menu	

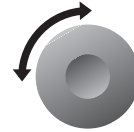

Step 4

Turn, then push the knob to change the setting. You must push the knob to save the change.

40

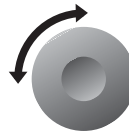

Then



Silence alarms

The alarm silence key silences current alarms for 120 seconds. When no alarm is active, holding down the alarm silence key for one second pre-silences low or medium priority alarms for 90 seconds. Minimum monitoring cannot be pre-silenced.

- The screen shows the time remaining in the silence period.
- Pushing the alarm silence key while an alarm is silenced will reset the countdown time to 120 seconds.
- High priority alarms always cause an audible tone and must be silenced individually.



AB.29.004

Alarm tones identify the alarm priority:

- High Priority: 10 tones, 10 seconds pause, (repeat)...
- Medium Priority: 3 tones, 25 seconds pause, (repeat)...
- Low Priority: single tone.

Alarms appear at the top of the screen. The highest priority alarm will be shown in Area 1, the next highest priority alarm in area 2. If all areas are used, the lowest priority alarms cycle in area 4.

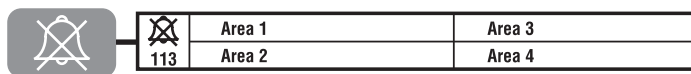

AB.90.072

Note: Error mode messages may appear. Refer to 'Alarms and Troubleshooting' in Part 2 of the Operation Manual for more information.

- Minimum Monitoring: Monitoring data is available but a failure prevents mechanical ventilation.
- Minimum System Shutdown: Monitoring and ventilation are not possible.

Reading the pressure waveform (Paw)

Different points on the waveform are instantaneous values for measured pressures. The horizontal axis indicates the time scale for the rate, I:E ratio, and inspiratory pause (volume control setting). The vertical axis indicates the pressure.

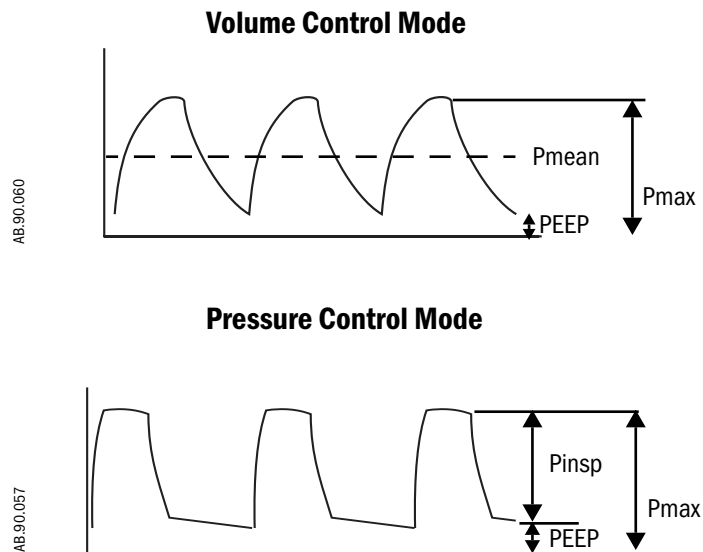

Scales

The display automatically adjusts time and pressure scales to fit the control settings.

The time scale changes with the set Rate:

- 25 or less breaths per minute - time scale is 0 to 16 seconds
- 26 to 75 breaths per minutes - time scale is 0 to 8 seconds
- 76 or more breaths per minutes - time scale is 0 to 4 seconds
- On a change, existing pressure data is erased and new waveform data starts at time = 0

The pressure scale changes with the P_{limit} setting:

- 12 to 40 P_{limit}, y-axis range is -5 to 40
- 41 to 60 P_{limit}, y-axis range is -5 to 60
- 61 to 100 P_{limit}, y-axis range is -5 to 100
- When the pressure scale changes, existing pressure data is erased and new waveform data starts at time = 0

Example Volume Control

- PEEP: Off
- Maximum sensed inspiratory pressure (Pmax): 25
- Mean positive airway pressure (Pmean): 11

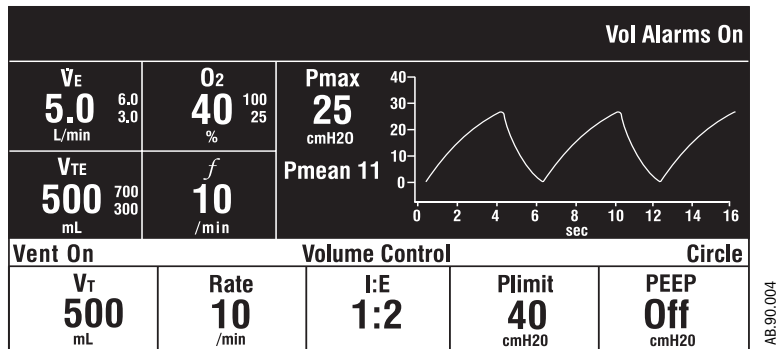

Figure 3-1 • Paw waveform in Volume Control mode

Example Pressure Control

- Pmax: 34
- Upper pressure limit (Plimit): 40
- PEEP: 10

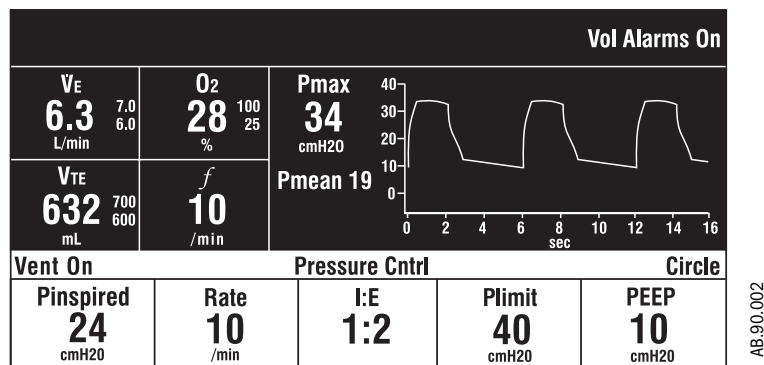
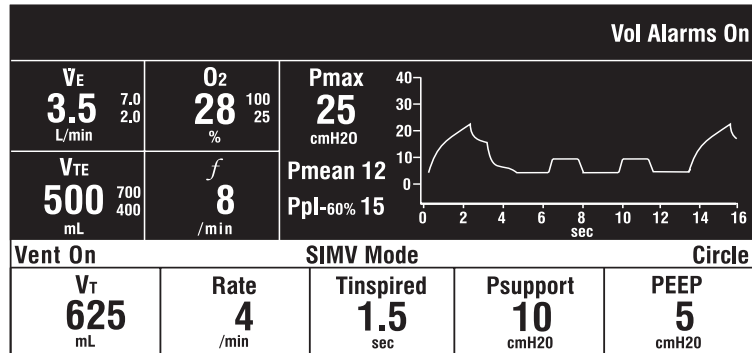

Figure 3-2 • Paw waveform in Pressure Control mode

Example SIMV

- Plateau pressure (Ppl): 15
- Inspiratory time (Tinspired): 1.5
- Inspiratory Pause: 60



AB.90.028

Figure 3-3 • Paw waveform in SIMV mode.

Example PSVPro

- PEEP: 5
- Pressure support: 10
- Mean positive airway pressure (Pmean): 7

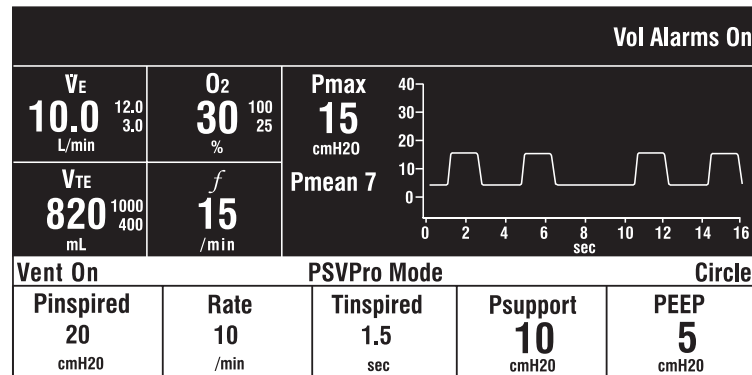

AB.90.087

Figure 3-4 • Paw waveform in PSVPro mode.

Measure circuit compliance

To measure compressible volume in patient tubes:

1. Set the ventilator to volume control mode.
2. Set a tidal volume (V_T) of 500 mL
3. Set a rate of 10 breaths/min.
4. Set an I:E ratio of 1: 1
5. Set the P_{limit} control to 30 cmH₂O.
6. Occlude the patient connection of the Y piece. Do not contaminate a clean patient connection.
7. Turn on mechanical ventilation.
8. Monitor the exhaled tidal volume V_{TE} and P_{max} (measured peak airway pressure).

The V_{TE} measures the gas needed to fill the patient circuit at the measured pressure.

The example shows how tubing compliance factor can be calculated.

$$V_{TE}/(P_{max} - 2.5^1 \text{ cmH}_2\text{O}) = \text{Compliance factor in mL per cmH}_2\text{O}$$

Example:

$$P_{max} = 21 \text{ cmH}_2\text{O}$$

$$V_{TE} = 24 \text{ mL}$$

$$24/(21 - 2.5) = 1.3 \text{ mL/cmH}_2\text{O}$$

This factor can be used to calculate the approximate gas compression in patient tubes.

For example, if the patient is requiring 30 cmH₂O to ventilate, 30 X 1.3 = 39 mL of gas is compressed in the tubes each breath. This gas (39 mL) is part of the set tidal volume but it does not reach the patient.

¹ Force of the Bellows.

Show the service settings

The About Ventilator screen shows ventilator settings that can only be changed by an approved service representative.

Item	Use
Software Version	If you call for service, a representative may ask for this.
Facility defaults or last settings	Tells you if the system saves the current settings when you turn it off or goes back to facility defaults.
Altitude	Used for gas calculations. If the altitude is not correct, O ₂ calibration can fail.
Drive gas (O ₂ or Air)	Tells you which gas the ventilator uses to drive the bellows. This gas comes from the same supply (pipeline or cylinder) that the anesthesia machine uses. If this gas comes from a cylinder, the cylinder empties faster than you would expect from the flowmeter settings.

Step 1

Select the Setup/Calibration menu.

- Push the menu key.
- Turn, then push the knob to select Setup/Calibration.

AB.29.013



AB.90.036

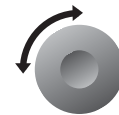
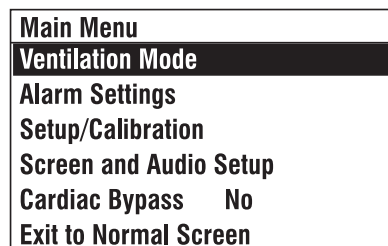

AB.90.037

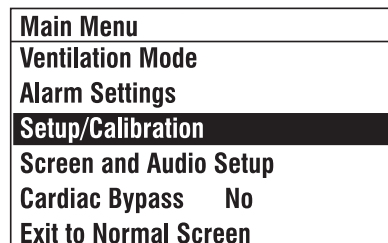

Step 2

Turn, then push the knob to select About Ventilator.

AB.90.045

Setup/Calibration	
SIMV/PSVPro Setup	
O ₂ Sensor Cal	
Inspiratory Pause	Off
Heliox Mode	Off
About Ventilator ...	
Go to Main Menu	

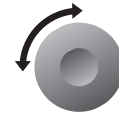

AB.90.047

Setup/Calibration	
SIMV PSVPro Setup	
O ₂ Sensor Cal	Start
Inspiratory Pause	20%
Heliox Mode	Off
About Ventilator ...	
Go to Main Menu	



AB.90.051

About Ventilator ...	
Software Version	4.0
Facility defaults used	@ powerup
Altitude	300 m
Drive Gas	O ₂
Go to Setup/Calibration Menu	

Optional Passive AGSS operation

The Aestiva/5 7100 Passive AGSS consists of a two-liter reservoir to minimize rapid pressure changes. It contains both positive and negative pressure relief valves to protect the breathing system. The outlet is a 30 mm male taper swivel connector (a) at the rear of the breathing system.

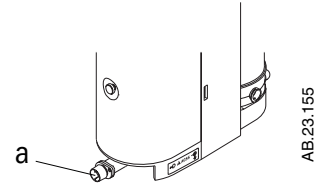

AB.23.155

The connector also has a capped hose barb that may be used for scavenging the sample from a gas monitor.

Passive AGSS (Anesthesia Gas Scavenging System) is intended primarily for use in operating room environments which have no dedicated vacuum system for waste gas disposal. The disposal system generally consists of large diameter tubing and/or duct directly linking the passive AGSS with the building exterior. The tubing should be as large in diameter and as short as needed for the particular application.

Passive AGSS may also be used with a non-recirculating ventilation system for waste gas disposal. The tubing connection from passive AGSS to the non-recirculating ventilation system should be an open connection, essentially at atmospheric pressure, such as to an exhaust grill.

Passive AGSS may also be used as a protective interface to an externally mounted active AGSS such as the Datex-Ohmeda adjustable Waste Gas Scavenging Interface Valve Assembly.

Optional Active AGSS operation

Versions There are at least three versions of the optional active AGSS (Anesthesia Gas Scavenging System) available for Aestiva depending on the hospital's type of waste gas disposal system.

The low flow system is for use with high vacuum disposal systems. It requires a minimum vacuum pressure at the wall of 300 mmHg (12 inHg). The extract flow is restricted to a nominal of 36 L/min or slightly higher at higher vacuum pressures. A flow indicator on the side of the breathing system indicates when the unit is in operation.

The high flow system is for use with low vacuum (blower type) disposal systems with nominal extract flow in the range of 50 to 80 L/min. A flow indicator on the side of the breathing system indicates when the unit is in operation.

The third type is for hospital supplied venturi/ejector systems having their own extract flowmeter. This will operate satisfactorily with a minimum extract flow of 30 L/min to 100 L/min, but there is no built-in flow indicator.

All three versions are constant extract flow, air brake designs with a two-liter reserve volume to capture peak exhaust flows that briefly exceed the extract flow. The disposal system normally entrains room air through the air brake, located underneath the breathing system and AGSS reservoir, but will spill from this port during extended periods of high exhaust flow.

Datex-Ohmeda AGSR assembly

The Datex-Ohmeda adjustable Anesthesia Gas Scavenging Receiver (AGSR) assembly may be externally mounted on the dovetail rail behind the breathing system, or on the back of the articulating arm. The AGSR is an active AGSS with adjustable extract flow. It may be useful with a low flow, high vacuum disposal system without the capacity for a constant 36 L/min extract flow. Refer to the instructions provided with the device. It is for use only with the Aestiva/5 internal passive AGSS.

Connecting Active AGSS with a flow indicator

To use the optional active AGSS on a system which has a flow indicator (on either the left or right side of the breathing system), connect it as follows.

Step 1

Connect the proper hose to the AGSS outlet connector (f) on the rear of the base of the breathing system.

Step 2

Attach the other end to the hospital disposal system.

Note: To scavenge gas from a gas monitor, connect tubing from the monitor to the 3.18 mm (1/8 inch) hose barb (g) in the breathing system base.

Step 3

With the AGSS operating, verify that the flow indicator ball (d) on the flow indicator (a) rises to the green zone (c), indicating adequate flow.

Note: The ball in the upper red zone (b) indicates excessively high extraction flow or a blocked filter. The ball in the lower red zone (e) indicates extraction flow rate is too low.

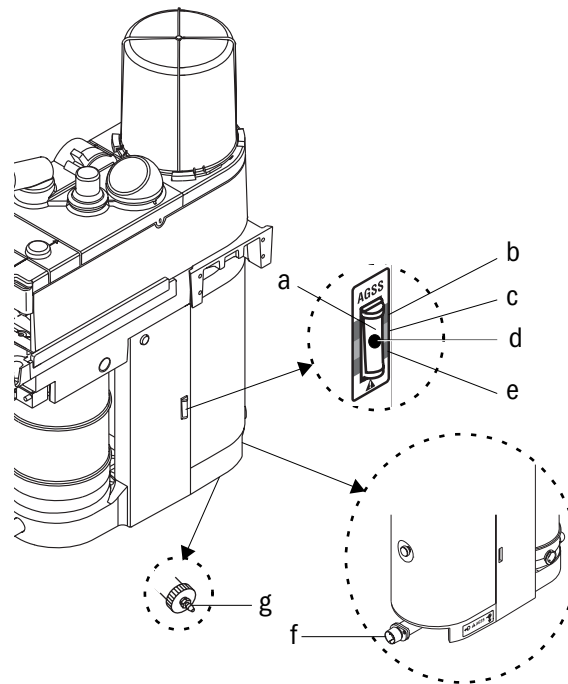

AB.23.155 AB.23.162 AB.23.174 AB.23.165

Step 4

Before you use the system, complete the Preoperative Test procedure. Refer to the Appendix "Preoperative Tests".

Connecting Active AGSS without a flow indicator

The active AGSS option without a flow indicator is for use only with hospital disposal systems having their own visual indicator of disposal flow rate.

The recommended nominal disposal system flow rate is 36 L/min but will operate satisfactorily between 30 and 100 L/min.

To use the optional active AGSS installed on the system which does not have a flow indicator, connect it as follows.

Step 1

Connect a nominal 1/2 inch ID hose to the AGSS outlet hose connector (a) on the rear of the breathing system base.

- The hose should be flexible and reinforced to help prevent kinking and crushing.

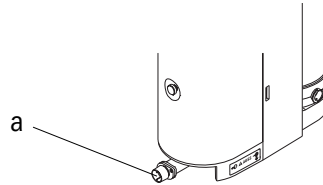

AB.23.155

Step 2

Attach the other end of the hose to the hospital disposal system.

Step 3

Before you use the system, complete the Preoperative Test procedure. Refer to the Appendix "Preoperative Tests".

4 Preoperative Checklist

In this section

This section is a checklist of the necessary preoperative tests under different conditions. For step-by-step instructions, refer to the appendix “Preoperative Tests.”

WARNING

Do not use this system unless you have read each component’s operation and maintenance manual and understand:

- The system connections
- The warnings and cautions
- How to use each system component
- How to test each system component

WARNING

Before you use this system:

- Complete the tests in this section
- Test all other system components

WARNING

If a test failure occurs, do not use the system. Have an approved service representative repair the system.

Every day before the first patient	4-2
Every time a different clinician uses the system	4-3
Before every patient	4-3

**Every day
before the first patient**

- Inspect the system. Look for damage, necessary drugs and equipment, correct breathing circuit setup, and hazardous conditions.
- Turn on the system.
- Set the ventilator controls to decrease alarms.
- Do the pipeline and cylinder tests. Look for sufficient pressures and no high pressure leaks (cylinders).
- Do the flow control tests:
 - Minimum flows: O₂ 25-75 mL/min, all other gases no flow.
 - Link system: Increase N₂O flow to drive up O₂ flow. Decrease O₂ flow to drive down N₂O flow. The O₂ flow is ≥ nominal 25%.
 - O₂ supply failure alarm. Alarm operates when O₂ pressure is decreased below set limit. Air flow continues. All other gases stop.
- Do the vaporizer back pressure tests:
 - Set the O₂ flow to 6 L/min.
 - Turn On one vaporizer at a time.
 - Make sure that the O₂ flow stays above 5 L/min.
- Do a low-pressure leak test.
- Do the alarm tests:
 - Make sure all monitors operate correctly.
 - Make sure the O₂ sensor operates correctly. It shows approximately 21% O₂ in room air and 100% O₂ after two min in pure O₂.
 - Make sure these ventilator alarms operate correctly: high and low O₂; low minute volume; high airway pressure; apnea and low airway pressure; sustained airway pressure.

**Every time a different
clinician uses the system**

- Do a low-pressure leak test.

Before every patient

- Look for damage, necessary drugs and equipment, correct breathing circuit setup, and hazardous conditions.

- Check vaporizer installation:

- Make sure the top of each vaporizer is horizontal (not on crooked).
- Make sure each vaporizer is locked and cannot be removed.
- Make sure the alarms and indicators operate correctly (Tec 6 vaporizer).
- Make sure you cannot turn on more than one vaporizer at the same time.

- Do the breathing system tests:

- Make sure the one way valves and auxiliary equipment (humidifier, etc.) operate correctly.
- With a circle breathing-circuit module, push the drain button for ≥ 10 sec to remove condensate.
- Ventilator circuit leak test.
- Bag/Manual circuit leak test.
- Bag/Manual circuit APL valve test.
- Circuit leak test.

- Set the appropriate controls and alarm limits for the case.

Aestiva

Appendix - Preoperative Tests

In this section

- Test Intervals A-2
- Every day before the first patient A-3
- Precase steps. A-11
- Every time a different clinician uses the system A-12
- Low-pressure leak test A-12
- Before every patient A-16
- Breathing system tests A-19
- Monitor and ventilator tests A-21

Test Intervals

The preoperative tests are done at one of three intervals:

1. Every day before the first patient
2. Every time a different clinician uses the system
3. Before each patient



WARNING

Do not use this system unless you have read each component's operation and maintenance manual and understand:

- All system connections
- All of the warnings and cautions
- How to use each system component
- How to test each system component

Before you use this system:

- Complete all of the tests in this section
- Test all other system components

If a test failure occurs, do not use the equipment. Have an approved service representative repair the equipment.

Every day before the first patient

Inspect the System

 **WARNING** Make sure that the breathing circuit is correctly connected and not damaged.

 **CAUTION** The total weight on each accessory shelf must be less than 23 kg.
Systems without accessory shelves have a weight limit on the top surface of 23 kg.

Make sure that:

1. The equipment is not damaged.
2. All components are correctly attached.
3. The breathing circuit is correctly connected, not damaged, and contains sufficient absorbent.
4. The vaporizers are locked in position and contain sufficient agent.
5. Pipeline gas supplies are connected and the pressures are correct.
6. Cylinder valves are closed on models with cylinder supplies.

 **WARNING** Do not leave gas cylinder valves open if the pipeline supply is in use. Cylinder supplies could be depleted, leaving an insufficient reserve supply in case of pipeline failure.

7. Models with cylinder supplies have a cylinder wrench attached to the system.
8. The necessary emergency equipment is available and in good condition.
9. Equipment for airway maintenance, tracheal intubation, and IV administration is available and in good condition.
10. Applicable anesthetic and emergency drugs are available.
11. With the optional O₂ flowmeter and suction regulators, turn the devices On and make sure that:
 - The O₂ flowmeter provides sufficient flow.
 - The suction regulator provides adequate suction.

Note: system gas supplies must be connected. Non-venturi suction regulators must be connected to a vacuum source.

12. On trolley model, make sure the casters are not loose and the brake is set and prevents movement.

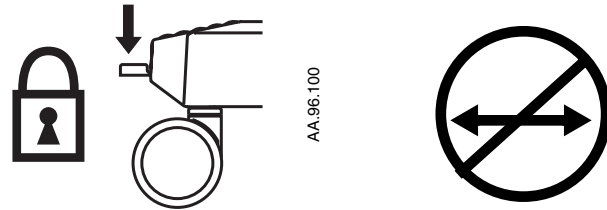

13. Connect the power cord to a wall outlet. The mains indicator comes On when AC Power is connected.

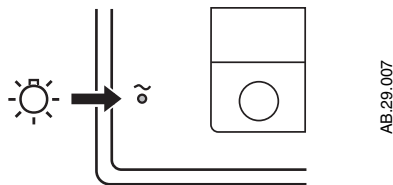

- If the indicator is not on, the system does not have mains (electrical) power. Use a different outlet. Close the circuit breaker or replace or connect the power cable. Refer to Figure 2-2.

14. Set the system switch to On.



Minimize alarms (optional)

Set the ventilator controls to decrease the number of alarms:

1. Control Keys:
 - Volume alarms: Off
 - Plimit: 100 cmH₂O
2. Alarm menu:
 - Low O₂: 21%
 - High O₂: Off
 - Bag/Vent switch: Bag

Pipeline and cylinder tests



CAUTION

To prevent damage:

- Open the cylinder valves slowly.
- Do not force the flow controls.

If your system does not use cylinder supplies, do not do steps 2 and 3.

1. Disconnect the pipeline supplies and close all cylinder valves.
If the pipeline and the cylinder pressure gauges are not at zero:
 - Connect an O₂ supply.
 - Turn On the system, if it is not already on.
 - Set the flow controls to mid range.
 - Make sure that all gauges but O₂ go to zero.
 - Disconnect the O₂ supply.
 - Make sure that the O₂ gauge goes to zero. As pressure decreases, alarms for low O₂ supply pressure should occur.
2. Make sure that the cylinders are full:
 - Open each cylinder valve.
 - Make sure that each cylinder has sufficient pressure. If not, close the applicable cylinder valve and install a full cylinder.
3. Test one cylinder at a time for high-pressure leaks:
 - Set the system switch to Standby, which stops the O₂ flow.
 - Disconnect all accessories from the pneumatic outlets.
 - Turn Off the auxiliary O₂ flowmeter.
 - Open the cylinder.
 - Record the cylinder pressure.

- Close the cylinder valve.
- Record the cylinder pressure after one minute. If the pressure decreases more than 690 kPa (100 psig) there is a leak:
 - Install a new cylinder gasket and tighten the tee handle as shown in the Setup section of the Setup, maintenance and troubleshooting manual.
 - Do this step again. If the leak continues, do not use the system.
- Repeat step 3 for all cylinders.
- Close cylinder valves.

⚠ WARNING

Do not leave gas cylinder valves open if the pipeline supply is in use. Cylinder supplies could be depleted, leaving an insufficient reserve supply in case of pipeline failure.

4. Connect the pipeline supplies.
5. Turn on the system.
6. Use the chart below to check pipeline pressure:

ANSI (USA and Intl.), Australian, Canadian, French, Japanese 345 kPa (50 psig)

ISO, Italian, Scandinavian, South African, Spanish, Swiss 414 kPa (60 psig)

Austrian, German 500 kPa (75 psig)

7. Connect equipment to the pneumatic outlets as appropriate.

Flow control tests

⚠ WARNING The Link system cannot replace an O₂ monitor. Sufficient O₂ in the fresh gas may not prevent hypoxic mixtures in the breathing circuit.

Nitrous oxide (N₂O) flows through the system during this test. Use a safe and approved procedure to collect and remove it.

Incorrect gas mixtures can cause patient injury. If the Link system does not supply O₂ and N₂O in the correct proportions, do not use the system.

To perform the flow control tests:

1. Connect the pipeline supplies or slowly open the cylinder valves.
2. Turn all flow controls fully clockwise (minimum flow).
3. Turn on the system.
4. Do not use the system if low battery or other ventilator failure alarms occur.
5. Make sure the O₂ flowtube shows approximately 25 to 75 mL/min. The other flowtubes must show no gas flow.

⚠ WARNING Keep the Link system engaged during steps 6 and 7:

- Adjust only the test control (N₂O in step 6 and O₂ in step 7).
 - Test the flows in sequence (N₂O then O₂).
 - If you adjust the test control too far, set the flow controls to their initial positions and do the step again.
 - The O₂ sensor used in steps 6 and 7 must be correctly calibrated.
6. Test the N₂O flow control:
 - Turn the N₂O and O₂ flow controls fully clockwise (minimum flow).
 - Slowly turn the N₂O flow control counterclockwise.
 - Make sure that the O₂ flow increases.
The measured O₂ concentration must be ≥21% through the full range.

7. Test the O₂ flow control:
 - Set the N₂O flow to 9.0 L/min.
 - Set the O₂ flow to 3 L/min or higher.
 - Slowly turn the O₂ flow control clockwise.
 - Make sure that the N₂O flow decreases.
The measured O₂ concentration must be ≥21% through the full range.
8. Set the flow controls to mid range and make sure that the flowtube floats move smoothly.
9. Stop the O₂ supply. Disconnect the pipeline supply or close the cylinder valve.
10. Make sure that:
 - The low O₂ supply alarm occurs.
 - N₂O, CO₂, Heliox, and O₂ flows stop. The O₂ flow stops last.
 - Air flow continues.
 - Gas supply alarms occur on the ventilator if the ventilator uses O₂ as the drive gas.
11. Turn all of the flow controls fully clockwise (minimum flow).
12. Reconnect the pipeline supplies.

Vaporizer back pressure test

WARNING

Anesthetic agent comes out of the common gas outlet during this test. Use a safe, approved procedure to remove and collect the agent.

CAUTION

To prevent damage, turn the flow controls fully clockwise (minimum flow or Off) before you turn On the system.

1. Turn the system On. Alarms can occur.
2. Set the O₂ flow to 6 L/min.
3. Make sure that the O₂ flow stays constant and the float moves freely.
4. Adjust the vaporizer concentration from 0 to 1% one click at a time. The O₂ flow must not decrease more than 1 L/min through the full range.

If the O₂ flow decreases more than 1 L/min:

- Install a different vaporizer and try this step again.
- If the O₂ flow decreases less than 1 L/min with a different vaporizer, the malfunction is in the first vaporizer.

- If the O₂ flow also decreases more than 1 L/min with a different vaporizer, the malfunction is in the Aestiva. Do not use the Aestiva system until it is serviced.
5. Complete steps 3 and 4 for each vaporizer.

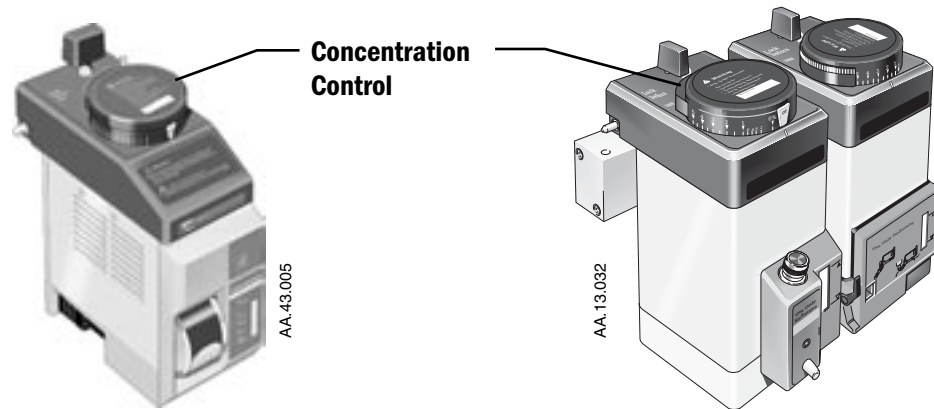

Power failure test

1. Unplug the power cord with the system turned On.
2. Make sure that the power failure alarm comes on.
3. Connect the power cable again.
4. Make sure the alarm cancels.

Alarm tests

1. Connect a test lung to the patient connection.
2. Set the Bag/Vent switch to Vent.
3. Set the controls:
 - Ventilation Mode: Volume control (Select from main menu)
 - Ventilator:
 - Tidal Vol: 400 ml
 - Rate: 12
 - I:E Ratio: 1:2
 - Plimit: 40 cmH₂O
 - PEEP: Off
 - Anesthesia Machine
 - O₂ flow: minimum flow (25-75 mL/min)
 - All other gases: Off
 - Push flush to fill the bellows.
4. Make sure that:
 - Mechanical ventilation starts.
 - A subatmospheric pressure alarm does not occur.
 - The ventilator displays the correct data.
 - The bellows inflate and deflate during mechanical ventilation.
5. Set the O₂ flow control to 5 L/min.
6. Make sure that:
 - The end expiratory pressure is approximately 0 cmH₂O.
 - The ventilator displays the correct data.
 - The bellows inflate and deflate during mechanical ventilation.
7. Test the O₂ monitor and alarms:
 - Make sure the sensor measures approximately 21% O₂ in room air.
 - Set the low O₂ alarm to 50%. Make sure a low O₂ alarm occurs.
 - Set the low O₂ alarm back to 21% and make sure that alarm cancels.
 - Put the O₂ sensor back in the circuit.
 - Set the High O₂ alarm to 50%.
 - Push the flush button to fill the breathing system.
 - Make sure the high O₂ alarm comes On.
 - Set the high O₂ alarm back to 100% and make sure that alarm cancels.
 - After 2 min. in pure O₂, the sensor measures approximately 100% O₂.
8. Test the low minute volume alarm:
 - Go to the alarms menu.
 - Set the alarm limit for low minute volume to 6.0 L/min.

- Make sure that a low minute volume alarm occurs.
 - Go to the alarms menu.
 - Set the low minute volume alarm to Off.
9. Test the high airway pressure alarm:
- Set Plimit to less than the peak airway pressure.
 - Make sure that the high airway pressure alarm occurs.
 - Set Plimit to the correct level.
10. Test the apnea and low airway pressure alarms:
- Remove the test lung from the patient connection.
 - Other alarms such as low minute volume can occur.
 - Make sure that the low airway pressure and apnea alarms occur. The apnea alarm occurs after 30 sec.
11. Test the sustained airway pressure alarm:
- Set the controls:

APL Valve	Closed
-----------	--------

Bag/Vent switch:	Bag
------------------	-----

- Mechanical ventilation stops when the Bag/Vent switch is set to Bag.
- Close the patient connection and push the O₂ Flush button.
- Make sure that the sustained pressure alarm occurs after approximately 15 seconds at the sustained pressure limit (6-30 cmH₂O varies with pressure limit).

Precase steps

1. Before the first case, do a low-pressure leak test. Refer to “Every time a different clinician uses the system.”
2. Do the last two sections of tests in “Before every patient”:
 - Breathing system tests
 - Monitor and ventilator tests

Every time a different clinician uses the system

The following tests must be performed every time a different clinician uses the anesthesia system.

⚠ WARNING

Do not use a system with a low-pressure leak. Anesthetic gas will go into the atmosphere, not into the breathing circuit.

Low-pressure leak test

Negative low-pressure leak test

1. Turn on the auxiliary common gas outlet (AUX some models).

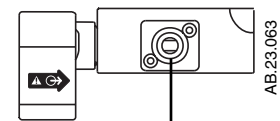
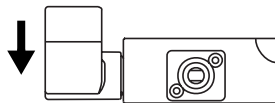

AUX

AB.23.063

2. Or, access the common gas outlet (CGO).

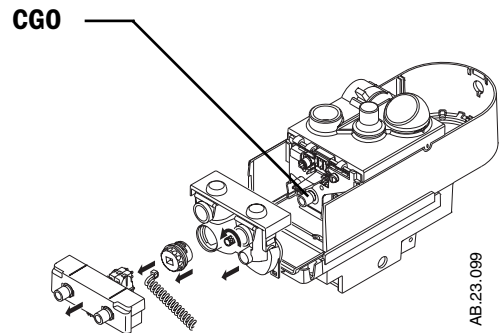
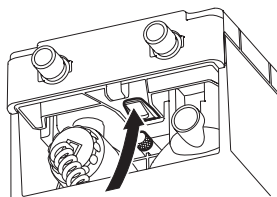

AB.23.099

3. Test the leak test device:

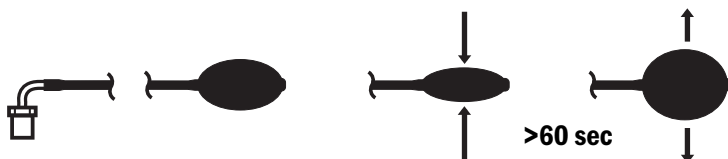

AB.23.063

- Put your hand on the inlet of the leak test device. Push hard for a good seal.
 - Remove all air from the bulb.
 - If the bulb inflates in less than 60 seconds, replace the leak test device.
4. Set the system switch to Standby.
 5. Turn off all vaporizers.
 6. Test the anesthesia machine for low-pressure leaks:
 - Turn the flow controls one and a half turns counterclockwise.
 - Connect the test device to the common or auxiliary gas outlet.
 - Compress and release the bulb until it is empty.
 - The vacuum causes the floats to move. This is usual. If the bulb inflates in 30 seconds or less, there is a leak in the low-pressure circuit. Refer to the Troubleshooting table (Part 2 of this manual).
 - Disconnect the test device.
 7. Test each vaporizer for low-pressure leaks:
 - Set the vaporizer to 1%
 - Repeat step 6. If there is a low-pressure leak, refer to the Setup, Maintenance and Troubleshooting Manual.
 8. Keep the test device with the system.
 9. Turn all flow controls fully clockwise (minimum flow). Do not over tighten.

 **WARNING** Agent mixtures from the low-pressure leak test stay in the system. Always flush the system with O₂ after the low-pressure leak test (1 L/min for one minute).

 **WARNING** Turn off all vaporizers at the end of the low-pressure leak test.

10. Remove all condensate from the breathing circuit module.
11. Assemble the breathing system.
12. Flush the system with O₂:
 - Turn on the system.
 - Set the O₂ flow to 1 L/min.
 - Continue the O₂ flow for one minute.
 - Turn the O₂ flow control fully clockwise (minimum flow).
 - Set the system switch to Standby.

**ISO 5358 or BSI
low-pressure leak test**

⚠ CAUTION: You can only do a positive pressure test at the common gas outlet.

1. Access the common gas outlet (CGO).

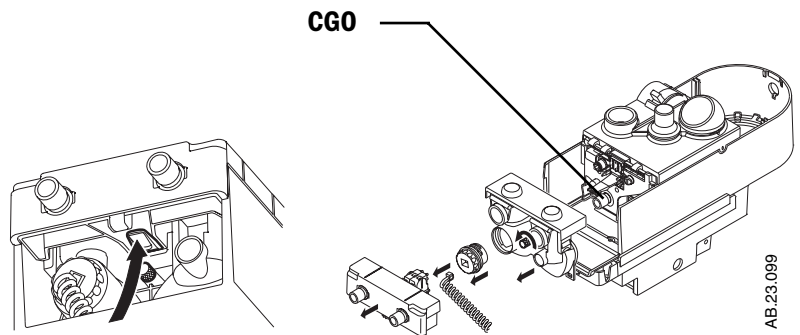

2. Connect the leak test device to the common gas outlet with a section of tubing.

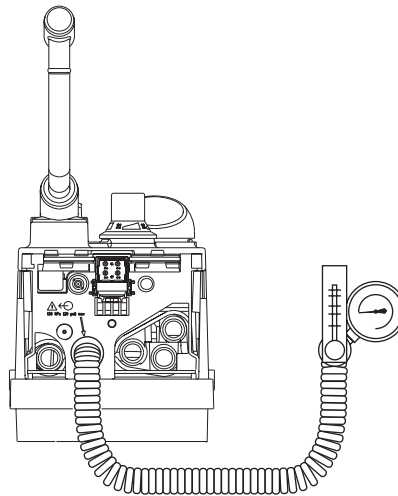

- Turn off the auxiliary common gas outlet.
 - Set the Outlet switch to common gas outlet.
 - Keep the flow tube vertical for accurate results.
3. Fully close all flow controls.
 4. Fully open the needle valve on the test device.

⚠ CAUTION If the needle valve is not fully open, this test can damage the pressure gauge on the test device.

5. Open the Air or N₂O flow control and set a total flow of 0.4 L/min through the flowmeter on the test device.
6. Make sure that the pressure gauge on the test device reads zero and that all other flow controls are fully closed.

7. Close the needle valve on the test device until the test gauge reads:

BSI	20 kPa
ISO 5358	3 kPa

8. If the flow through the test device is less than 0.35 L/min (ISO) or 0.3 L/min (BSI), there is a low-pressure leak in the anesthesia machine. Refer to the Setup, Maintenance and Troubleshooting Manual.
9. Repeat this low-pressure leak test for each vaporizer:
 - Set the applicable vaporizer to 1% and do steps 2 through 8.
 - Fully open the needle valve on the test device to decrease the back pressure.
 - Turn the vaporizer off.

⚠ WARNINGS Agent mixtures from the low-pressure leak test stay in the system. Always flush the system with O₂ after the low-pressure leak test (1 L/min for one minute).

Turn all vaporizers Off at the end of the low-pressure leak test.

10. Remove all condensate from the breathing circuit module.
11. Assemble the breathing system.
12. Flush the system with O₂:
 - Turn the system On.
 - Set the O₂ flow to 1 L/min.
 - Continue the O₂ flow for one minute.
 - Turn the O₂ flow control fully clockwise (minimum flow).
 - Set the system switch to Standby.

Before every patient

Inspect the system

Before each case, perform the following anesthesia system checks.

 **WARNING** Make sure that the breathing circuit is correctly connected and not damaged.

 **CAUTION** The total weight on each accessory shelf must be less than 23 kg.
Systems without accessory shelves have a weight limit on the top surface of 23 kg.

Make sure that:

1. The equipment is not damaged.
2. All components are correctly attached.
3. The breathing circuit is correctly connected, not damaged, and contains sufficient absorbent.
4. The vaporizers are locked in position and contain sufficient agent.
5. Pipeline gas supplies are connected and the pressures are correct.
6. Cylinder valves are closed on models with cylinder supplies.

 **WARNING** Do not leave gas cylinder valves open if the pipeline supply is in use. Cylinder supplies could be depleted, leaving an insufficient reserve supply in case of pipeline failure.

7. Models with cylinder supplies have a cylinder wrench attached to the system.
8. The necessary emergency equipment is available and in good condition.
9. Equipment for airway maintenance, tracheal intubation, and IV administration is available and in good condition.
10. Applicable anesthetic and emergency drugs are available.

11. On trolley model, make sure the casters are not loose and the brake is set and prevents movement.

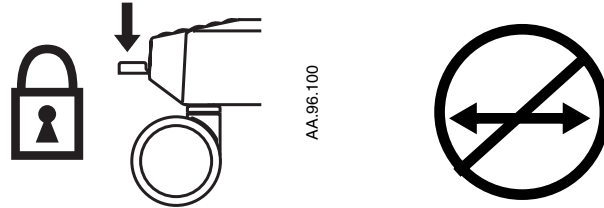

12. Connect the power cord to a wall outlet. The mains indicator comes on when AC Power is connected.

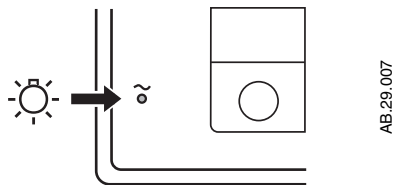

- If the indicator is not on, the system does not have mains (electrical) power. Use a different outlet. Close the circuit breaker or replace or connect the power cable. Refer to Figure 2-2.

13. Set the system switch to On.



Minimize alarms (optional)

Set the ventilator controls to decrease the number of alarms:

1. Control Keys:
 - Volume alarms: Off
 - Plimit: 100 cmH₂O
2. Alarm menu:
 - Low O₂: 21%
 - High O₂: Off
3. Bag/Vent switch: Bag

After you have finished testing, set the Plimit back to a clinically appropriate value.

Vaporizer installation



WARNING

Use only the Tec 5, Tec 6, and Tec 7 vaporizers.

Do not use a vaporizer that lifts off the manifold when the lock lever is in the locked position.

Do not use this anesthesia system if you can turn on more than one vaporizer at the same time.

Tec 6 vaporizers will not align correctly unless the power cable goes through the channel on the bottom of the vaporizer. Do not put the power cable on top of the manifold or between vaporizers.

The vaporizer storage bracket is not part of the vaporizer manifold. You cannot use a vaporizer while it is on the bracket.

1. If the top of a vaporizer is not horizontal, remove the vaporizer and reinstall it.
2. Set each vaporizer lock lever to the locked position.
3. Try to lift each vaporizer off of the manifold.
4. If a vaporizer lifts off the manifold, install it again and complete steps 1, 2, and 3. If the vaporizer lifts off a second time, do not use the system.

5. With a Tec 6 vaporizer:
 - Make sure that the vaporizer is under the Tec 6 electrical outlet.
 - Make sure that the vaporizer is connected to an electrical outlet.
 - Hold down the alarm silence switch for a minimum of four seconds.
 - Make sure all indicators come on and the alarm speaker starts.
 - Release the alarm silence switch.
 - Do not continue until the operational indicator comes on. The concentration control will not turn if the operational indicator is off.
6. Try to turn on more than one vaporizer at the same time:
 - Test each possible combination.
 - If more than one vaporizer turns on at the same time, remove the vaporizers, install them again, and complete steps 1 through 6.

Breathing system tests

Refer to the applicable operation and maintenance manuals.

At a minimum:

1. Make sure that the auxiliary equipment (humidifier, etc.) operates correctly.
2. Absorbers with active scavenging have a flow tube on the side. Make sure that it shows a flow in the green (normal) region.
3. With a circle breathing module, push the drain button for 10 seconds or more to drain condensate into the absorber.

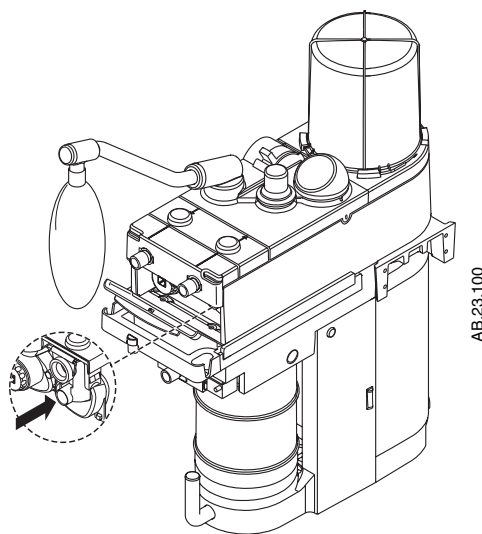

4. Make sure that the one-way valves (breathing circuit module) work correctly.
 - The inspiratory check valve rises during inspiration and falls at the start of expiration.
 - The expiratory check valve rises during expiration and fall at the start of inspiration.

Note: The Bain/Mapleson D circuit module does not have one-way valves.

⚠ WARNING Objects in the breathing system can stop gas flow to the patient. This can cause injury or death:

- On Circle systems, press the drain button for a minimum of 10 seconds to remove moisture buildup.
- Do not use a test plug that is small enough to fall into the breathing system.

⚠ WARNING Make sure that there are no test plugs or other objects caught in the breathing system.

5. Test the ventilator circuit for leaks:
 - Set the Bag/Vent switch to Vent.
 - Set all flow controls to minimum.
 - Set the system switch to Standby.
 - Close the breathing circuit at the patient connection. Use your hand or an approved test plug located in the handle of the breathing system.
 - Push flush to fill the bellows.
 - The pressure must not increase to more than 15 cmH₂O on the gauge.
 - If the bellows falls more than 100 mL/min, it has a leak. Refer to the troubleshooting procedure in the Setup, Maintenance and Troubleshooting manual.
 - Turn on the system.
6. Test the Bag circuit for leaks:
 - Set the Bag/Vent switch to Bag.
 - Close the APL valve.
 - Set the O₂ flow to 250 mL/min.
 - Close the patient connection (hand or test plug) and inflate the bag (flush) to 30 cmH₂O.

- Release the flush button. The pressure must not decrease. A pressure decrease large enough to see on the gauge indicates a leak. Look for and repair the leak (loose drain plug, open canister, breathing circuit assembly not pushed on completely).
 - If your system has CO₂ bypass, move the absorber canister release to the open position and do this test again to look for leaks in the bypass.
- Note:** If the message window shows “Close absorber canister”, you DO NOT have a CO₂ bypass. Close the canisters and do step 6 again.
7. Test the APL valve:
 - Fully close the APL valve.
 - Set the total fresh gas flow to 3.0 L/min and make sure that the value on the inspiratory pressure gauge is less than approximately 82 cmH₂O.
 - Fully open the APL valve.
 - Make sure that the value on the inspiratory pressure gauge decreases to approximately zero.
 - Push the flush button and make sure that the value on the inspiratory pressure gauge stays near zero.
 - Set the O₂ flow to minimum and make sure that the value on the inspiratory pressure gauge does not decrease below 0 cmH₂O.
 8. Remove your hand (or the test plug - step 5) from the patient connection.

Monitor and ventilator tests

1. Connect a test lung to the patient connection.
2. Set the Bag/Vent switch to Vent.
3. Set the controls:
 - Ventilation Mode: Volume control (Select from main menu)
 - Ventilator:
 - Tidal Vol: 400 ml
 - Rate: 12
 - I:E Ratio: 1:2
 - Plimit: 40 cmH₂O
 - PEEP: Off
 - Anesthesia Machine
 - O₂ flow: minimum flow (25-75 mL/min)
 - All other gases: Off
 - Push flush to fill the bellows.
4. Make sure that:
 - Mechanical ventilation starts.
 - A subatmospheric pressure alarm does not occur.

Note: With active gas scavenging, too much scavenging flow can cause subatmospheric alarms.

- The ventilator displays the correct data.
 - The bellows inflate and deflate during mechanical ventilation.
5. Set the O₂ flow control to 5 L/min.
 6. Make sure that:
 - The end expiratory pressure is approximately 0 cmH₂O.

Note: Positive end expiratory pressure when PEEP is Off, may indicate that the scavenging system is not removing enough gas.

 - The ventilator displays the correct data.
 - The bellows inflate and deflate during mechanical ventilation.
 7. Set the ventilator controls and alarm limits to clinically appropriate levels.
 8. If the system will not be used immediately, set the system switch to Standby and close all cylinder valves.
 9. Make sure that you have:
 - Equipment for airway maintenance, manual ventilation, tracheal intubation, and IV administration.
 - Applicable anesthetic and emergency drugs.
 10. Prepare the system:
 - Turn all vaporizers off.
 - Open the APL valve.
 - Set the Bag/Vent switch to Bag.
 - Set all flow controls to minimum.
 - Set sufficient patient suction.
 - Make sure that the breathing system is correctly connected and not damaged.

 WARNINGS

Make sure that the breathing circuit is correctly connected and not damaged.

Before you connect a patient, flush the anesthesia machine with 5 L/min of O₂ for at least one minute. This removes unwanted mixtures and by-products from the system.

A

- About ventilator
 - show service settings 2-17
- About Ventilator... 3-32
- AGSS
 - connecting 3-34, 3-35
 - operation, active 3-33
- Alarm
 - tone indicates priority 3-26
- Alarm limits
 - how to set 3-9
 - show or hide option 2-17
 - show/hide 3-5
- Alarm settings
 - menu function 2-17
- Alarm Settings menu 3-9, 3-11
 - cardiac bypass 3-13
- Alarm silence
 - function 2-12
 - location 2-11
- Alarm volume
 - adjust 3-3
- Alarms
 - silence 3-26
- Alarms messages
 - display area for 2-11
- Altitude 3-31
- APL valve
 - function 2-6
 - location 2-5
- Apnea alarm
 - off during cardiac bypass 3-12
- Audible alarm for circuit leaks 3-11
- Auxiliary gas outlet
 - location 2-5
 - On/off 2-5
 - Stops ventilation 3-14
- Auxiliary outlet
 - switch function 2-8

B

- Bag arm
 - adjust position 2-6
 - location 2-5
- Bag/Vent switch
 - function 2-6
 - how to stop mech vent 3-15
 - start mechanical ventilation 3-14

- Bag/vent switch
 - location 2-5
- Bellows
 - location 2-5
- Brake
 - function of 2-3
- Breathing circuit Module
 - location 2-5
- Breathing circuit module
 - display 2-11
- Breathing system
 - controls 2-5
- Breathing system tests A-19

C

- Canister release
 - function 2-7
 - location 2-5
- Cardiac bypass
 - function 2-17
 - how to use 3-12
- Check valves
 - location 2-5
- Circuit breakers
 - location 2-4
- Circuit compliance
 - how to measure 3-30
- Circuit leak audio 3-11
 - turn on or off 2-17
- CO2 bypass
 - function 2-7
- CO2 Bypass operation 2-21
- Control knob
 - location 2-11
- Control settings
 - display 2-11

D

- Default settings 3-31
- Drain plug
 - function 2-7
- Drive gas 3-31

E

- Electrical outlet
 - location 2-4

Aestiva

End case key
function 2-13
location 2-11

F

Flow control tests A-7
Flow controls 2-2
function of 2-3
Flow Sensor
location 2-5
Flowmeter (external O2)
controls 2-20
location 2-19

G

Gas machine
controls 2-2
Gauge
airway pressure 2-5
cylinder pressure 2-2
pipeline pressure 2-2
Gooseneck lamp
location 2-2

H

Heliox
adjust patient data for heliox 3-7
Heliox mode
function 2-17

I

I
E ratio 3-19
Inspiratory pause
function 2-17
how to set 3-22

L

Light
switch 2-2
turn on and off 2-3
Low pressure leak test A-12

M

Mains indicator
location 2-11

Mains inlet
location 2-4
Measured values
display 2-11
Mechanical ventilation
how to start 3-1, 3-14
how to stop 3-15
Menu
how to change menu settings 2-18
how to change settings 2-18
how to use 2-15
menu map 2-16
what different functions do 2-17
Menu key
function 2-12
location 2-11
Minimum system 3-26
Modes
Pressure Control 3-20
PSVPro 3-21
SIMV 3-20
Volume Control 3-20
Monitor and ventilator tests A-21

O

O2 flush
function of 2-3
O2 sensor
location 2-5
O2 sensor cal
function 2-17
Options 1-2

P

PEEP 3-19, 3-21
Pinspired 3-19
Pipeline and cylinder supplies A-5
Pipeline connection
location 2-4
Plimit 3-19
Pneumatic outlet
location 2-4
Power failure alarm A-9
Power-up screen 3-2
Preoperative checklist 4-1
Preoperative test
power failure test A-9

- Preoperative tests
 - before every patient A-16
 - breathing system tests A-19
 - Every day A-3
 - Every time a different clinician uses the system A-12
 - flow controls A-7
 - monitor and ventilator tests A-21
 - pipeline and cylinder supplies A-5
 - recommended intervals A-2
 - vaporizer back pressure A-8
 - vaporizer installation A-18
 - ventilator alarms A-10
- Pressure control ventilation 3-16
- Pressure waveform 3-27
 - Pressure control 3-28
 - PSVPro 3-29
 - scales 3-27
 - SIMV 3-29
 - Volume control 3-28
- Psupport 3-19
- PSVPro
 - controls 3-24
- R**
- Rate 3-19
- S**
- Screen and audio
 - menu option 2-17
- Screen and Audio menu 3-3, 3-5
- Service settings
 - how to show 3-31
- Setup/calibration
 - menu options 2-17
- Setup/Calibration menu 3-7, 3-22, 3-31
- Shelf weight limit A-3
- Show/hide
 - alarm limits 3-4
 - units 3-4
- SIMV
 - controls 3-24
- Software version 3-31
- Suction regulator
 - controls 2-20
 - location 2-19
- System switch 2-2
 - function of 2-3
 - turn on 3-2
- T**
- Tidal volume 3-20
- Tinspired 3-19
- U**
- Units
 - show/hide option 2-17
- V**
- Vap. alarm silence
 - tec 6 key 2-9
- Vap. concentration control
 - function 2-9
- Vap. Lock lever
 - function 2-9
- Vaporizer
 - controls 2-9
- Vaporizer back pressure test A-8
- Vaporizer installation A-18
- VE auto limits 3-9
- Ventilation mode
 - display 2-11
 - how to set 3-16
- ventilator 3-18
- Ventilator alarm tests A-10
- Ventilator controls 3-19
 - how to set 2-14, 3-18
 - location 2-11
- Ventilator fuse
 - location 2-4
- Ventilator status
 - display 2-11
- Volume alarm key
 - function 2-12
 - location 2-11
- Volume alarms
 - how to turn on and off 3-8
- Volume control ventilation 3-16
- Vt comp off 3-26

Warranty

This Product is sold by Datex-Ohmeda under the warranties set forth in the following paragraphs. Such warranties are extended only with respect to the purchase of this Product directly from Datex-Ohmeda or Datex-Ohmeda's Authorized Dealers as new merchandise and are extended to the Buyer thereof, other than for the purpose of resale.

For a period of twelve (12) months from the date of original delivery to Buyer or to Buyer's order, but in no event for a period of more than two years from the date of original delivery by Datex-Ohmeda to a Datex-Ohmeda Authorized Dealer, this Product, other than its expendable parts, is warranted against functional defects in materials and workmanship and to conform to the description of the Product contained in this User's Reference manual and accompanying labels and/or inserts, provided that the same is properly operated under the conditions of normal use, that regular periodic maintenance and service is performed and that replacements and repairs are made in accordance with the instructions provided. This same warranty is made for a period of thirty (30) days with respect to expendable parts. The foregoing warranties shall not apply if the Product has been repaired other than by Datex-Ohmeda or in accordance with written instructions provided by Datex-Ohmeda, or altered by anyone other than Datex-Ohmeda, or if the Product has been subject to abuse, misuse, negligence, or accident.

Datex-Ohmeda's sole and exclusive obligation and Buyer's sole and exclusive remedy under the above warranties is limited to repairing or replacing, free of charge, at Datex-Ohmeda's option, a Product, which is telephonically reported to the nearest Datex-Ohmeda Customer Service Center and which, if so advised by Datex-Ohmeda, is thereafter returned with a statement of the observed deficiency, not later than seven (7) days after the expiration date of the applicable warranty, to the Datex-Ohmeda Customer Service and Distribution Center during normal business hours, transportation charges prepaid, and which, upon Datex-Ohmeda's examination, is found not to conform with above warranties. *Datex-Ohmeda shall not be otherwise liable for any damages including but not limited to incidental damages, consequential damages, or special damages.*

There are no express or implied warranties which extend beyond the warranties hereinabove set forth. Datex-Ohmeda makes no warranty of merchantability or fitness for a particular purpose with respect to the product or parts thereof.

Datex-Ohmeda

Corporate Office



Datex-Ohmeda Division
Instrumentarium Corp.
PO Box 900
FIN-00031 Helsinki
Finland
Tel 358 10 394 11
Fax 358 9 146 3310

North America

United States

Customer Service, Technical Support and Distribution Center

Datex-Ohmeda, Inc.
PO Box 7550
Madison, WI 53707-7550, USA
Tel 1 800 345 2700
Fax 1 608 221 4384

Equipment Service Center

Datex-Ohmeda, Inc.
Spacelabs Medical
22011 SE 51st Street
Issaquah, WA 98029, USA
Tel 1 800 287 7108
Fax 1 425 657 7232

Canada

Datex-Ohmeda (Canada) Inc.
1093 Meyerside Drive, Unit 2
Mississauga, Ontario
L5T 1J6
Canada
Tel 1 800 268 1472
Tel 1 905 565 8572
Fax 1 905 565 8592

Asia/Pacific

China

Datex-Ohmeda Pte Ltd Beijing
Representative Office
Room B1007-1008, COFCO Plaza
No. 8 Jianguomennei Avenue
Beijing 100005, PR China
Tel (86-10) 65269773
Fax (86-10) 65260653

Datex-Ohmeda Pte. Ltd.
Room 1708, Yunlong Mansion
No. 122 Luoguo Street
Chengdu 610017, PR China
Tel 86 28 661 4424
Fax 86 28 676 2703

Datex-Ohmeda Pte. Ltd.
Room 1602, GIE Tower
403 Huan Shi Dong Road
Guangzhou, 510095, PR China
Tel 86 20 8732 2521
Fax 86 20 8732 2518

Datex-Ohmeda Pte. Ltd.
Room 2509, Lippo Plaza
No. 222 Huaihai Road (M)
Shanghai 200021, PR China
Tel 86 21 5382 5657
Fax 86 21 5382 1619

Datex-Ohmeda Pte. Ltd.
Room 809, Truroll Plaza
Wusheng Road
Wuhan 430033, PR China
Tel 86 27 8571 2536
Fax 86 27 8571 2655

India

Datex-Ohmeda (India) Pvt. Ltd.
Block EP & GP, Sector V
Plot XI-16, Salt Lake City
Calcutta 700091
India
Tel 91 33 357 4002
Fax 91 33 357 4001

Indonesia

Datex-Ohmeda Pte. Ltd.
Wisma Danamon Aetna Life 19th Floor
Jln. Jend Sudirman Kav. 45-46 Jakarta
12930, Indonesia
Tel 62 21 575 0864
Fax 62 21 575 0865

Japan

Datex-Ohmeda K. K.
TRC Annex 9F
6-1-1 Heiwajima
Ohta-ku, Tokyo 143-0006
Japan
Tel 81 3 5763 6801
Fax 81 3 5763 6838

Datex-Ohmeda K. K.
Technical Center
TRC A Bldg. AE 4-8
6-1-1 Heiwajima
Ohta-ku, Tokyo 143-0006
Japan
Tel 81 3 5763 6850
Fax 81 3 5763 6852

Korea

Datex-Ohmeda Pte. Ltd.
10th Floor, Sam Sung Building
36 - 1, Yoido-Dong, Youngdeungpo-Ku
Seoul, Korea
Tel 82 2 786 7421
Fax 82 2 786 7420

Malaysia

Datex-Ohmeda Pte. Ltd.
Level 2 Bangunan O' Connor
13 Jalan 223
46100 Petaling Jaya
Selangor, West Malaysia
Tel 60 3 754 7872
Fax 60 3 757 6948

Singapore

Datex-Ohmeda Pte. Ltd.
152 Beach Road
#12-05/07 Gateway East
Singapore 189721
Tel 65 391 8618
Fax 65 291 6618

Taiwan and Philippines

Datex-Ohmeda Pte. Ltd.
2nd Floor, No. 85, Chien-Kuo North Road,
Sec. 2
Taipei, Taiwan
Republic of China
Tel 886-2 2515 0457
Fax 886-2 2501 9136

Thailand

Datex-Ohmeda Pte. Ltd.
12th Floor (Unit F) Grand Amarin Tower
1550 New Petchburi Road,
Makasan, Rajathevi,
Bangkok 10320, Thailand
Tel 66 2 2071012/13
Fax 66 2 207 1014

Vietnam

Datex-Ohmeda Pte. Ltd.
522G Nguyen Tri Phuong St.
Ho Chi Minh City, Dist. 10 Vietnam
Tel 848 865 5875
Fax 848 862 5501

Australia

Datex-Ohmeda Pty. Ltd.
Unit 1
149 Arthur Street
Locked Bag 356
NSW 2140 Homebush
Australia
Tel +61-2-9735 7222
Fax +61-2-9746 1796

Europe

CIS/Baltics

Datex-Ohmeda
Regional Head Office
PO Box 70071
GR-16610 Glyfada - Athens
Greece
Tel +30 10 962 5136-7
Fax +30 10 962 3687

France

Datex-Ohmeda S.A.S.
ZAC de Sans-Souci
1211 Chemin de la Bruyère
F-69760 Limonest
France
Tel 33 (0) 4 78 66 62 10
Fax 33 (0) 4 78 43 26 58

Germany

Datex-Ohmeda GmbH
Dr. Alfred-Herrhausen-Allee 24
D-47228 Duisburg
Germany
Tel 49 2065 691-0
Fax 49 2065 691-236

Italy

Datex-Ohmeda S.p.A.
Via Cassanese 100
20090 Segrate, Milan
Italy
Tel 39 2 21693431
Fax 39 2 26926226

Netherlands

Datex-Ohmeda B.V.
DE Wel 18
3871 MV Hoelvelaken
Netherlands
Tel +31 33 25 41 222
Fax +31 33 25 41 223

Spain

Datex-Ohmeda S.L.
C/Manuel Tovar 26
28034 Madrid
Spain
Tel 34 1 334 26 00
Fax 34 1 358 12 84

United Kingdom

Datex-Ohmeda Ltd.
Ohmeda House
71 Great North Road
Hatfield Hertfordshire
AL9 5EN England
Tel 44 1707 263570
Fax 44 1707 260191

Latin America, Caribbean

Datex-Ohmeda
9155 South Dadeland Blvd.
Suite 1218
Miami, FL 33156, USA
Tel 1 305 670 8540
Fax 1 305 670 2316

Middle East

Datex-Ohmeda
Regional Head Office
PO Box 70071
GR-16610 Glyfada - Athens
Greece
Tel +30 10 962 5136-7
Fax +30 10 962 3687

The addresses listed on this cover are current as of 6/03. For any location changes,
please visit our website at www.datex-ohmeda.com and click on the Contacts button.

Datex-Ohmeda, Inc.
PO Box 7550
Madison WI 53707-7550
USA
Tel 608 221 1551
Fax 608 222 9147
www.datex-ohmeda.com

Aestiva/5
Operaton Manual, English
1006 0938 000
10 03 C 02 13 07
Printed in USA
©Datex-Ohmeda, Inc. All rights reserved