

# Dash<sup>®</sup> 3000/4000 Patient Monitor Service Manual

2000966-035

Revision A



**GE Medical Systems**  
*Information Technologies*

---

[gemedicalsystems.com](http://gemedicalsystems.com)

NOTE: Due to continuing product innovation, specifications in this manual are subject to change without notice.

Listed below are GE Medical Systems *Information Technologies*' trademarks. All other trademarks contained herein are the property of their respective owners.

900 SC, ACCUSKETCH, AccuVision, APEX, AQUA-KNOT, ARCHIVIST, Autoseq, BABY MAC, C Qwik Connect, CardioServ, CardioSmart, CardioSys, CardioWindow, CASE, CD TELEMETRY, CENTRA, CHART GUARD, CINE 35, CORO, COROLAN, COROMETRICS, Corometrics Sensor Tip, CRG PLUS, DASH, Digistore, Digital DATAQ, E for M, EAGLE, Event-Link, FMS 101B, FMS 111, HELDIGE, IMAGE STORE, INTELLIMOTION, IQA, LASER SXP, MAC, MAC-LAB, MACTRODE, MANAGED USE, MARQUETTE, MARQUETTE MAC, MARQUETTE MEDICAL SYSTEMS, MARQUETTE UNITY NETWORK, MARS, MAX, MEDITEL, MEI, MEI in the circle logo, MEMOPOINT, MEMOPOINT C, MINISTORE, MINNOWS, Monarch 8000, MULTI-LINK, MULTISCRIPTOR, MUSE, MUSE CV, Neo-Trak, NEUROSCRIPT, OnlineABG, OXYMONITOR, Pres-R-Cuff, PRESSURE-SCRIBE, QMI, QS, Quantitative Medicine, Quantitative Sentinel, RAC RAMS, RSVP, SAM, SEER, SILVERTRACE, SOLAR, SOLARVIEW, Spectra 400, Spectra-Overview, Spectra-Tel, ST GUARD, TRAM, TRAM-NET, TRAM-RAC, TRAMSCOPE, TRIM KNOB, Trimline, UNION STATION, UNITY logo, UNITY NETWORK, Vari-X, Vari-X Cardiomatic, VariCath, VARIDEX, VAS, and Vision Care Filter are trademarks of GE Medical Systems *Information Technologies* registered in the United States Patent and Trademark Office.

12SL, 15SL, Access, AccuSpeak, ADVANTAGE, BAM, BODYTRODE, Cardiomatic, CardioSpeak, CD TELEMETRY®-LAN, CENTRALSCOPE, Corolation, EDIC, EK-Pro, Event-Link Cirrus, Event-Link Cumulus, Event-Link Nimbus, HI-RES, ICMMS, IMAGE VAULT, IMPACT.wf, INTER-LEAD, IQA, LIFEWATCH, Managed Use, MARQUETTE PRISM, MARQUETTE® RESPONDER, MENTOR, MicroSmart, MMS, MRT, MUSE CardioWindow, NST PRO, NAUTILUS, O<sub>2</sub>SENSOR, Octanet, OMRS, PHi-Res, Premium, Prism, QUIK CONNECT V, QUICK CONNECT, QT Guard, SMART-PAC, SMARTLOOK, Spiral Lok, Sweetheart, UNITY, Universal, Waterfall, and Walkmom are trademarks of GE Medical Systems *Information Technologies*.

© GE Medical Systems *Information Technologies*, 2000. All rights reserved.

# CONTENTS

## 1

<b>INTRODUCTION</b> .....	<b>1-1</b>
Manual Information .....	1-3
Revision History .....	1-3
Manual Purpose .....	1-3
Intended Audience .....	1-3
Safety Information .....	1-4
Responsibility of the Manufacturer .....	1-4
General .....	1-4
Warnings, Cautions, and Notes .....	1-5
Equipment Symbols .....	1-6
Service Information .....	1-8
Service Requirements .....	1-8
Equipment Identification .....	1-8

## 2

<b>EQUIPMENT OVERVIEW</b> .....	<b>2-1</b>
Components .....	2-3
The Monitoring System .....	2-3
The Patient Monitor .....	2-3
Optional RAC 2A Module Housing .....	2-6
Optional Wireless LAN System .....	2-7
Technical Specifications .....	2-8
Performance Specifications .....	2-8
ECG .....	2-9
Invasive Blood Pressure (BP) .....	2-10
Noninvasive Blood Pressure (NBP) .....	2-11
Pulse Oximetry (SPO <sub>2</sub> ) .....	2-12
Cardiac Output (CO) .....	2-12
Respiration .....	2-13
Temperature (TEMP) .....	2-13
Carbon Dioxide (CO <sub>2</sub> ) .....	2-13
Analog Output .....	2-15
Defibrillator Synchronization Pulse .....	2-15
Battery .....	2-16
Paper Recorder .....	2-16
RF Wireless LAN .....	2-16
Environmental Specifications .....	2-17
Physical Specifications .....	2-17
Certification .....	2-18
Warranty .....	2-19

# 3

**INSTALLATION . . . . . 3-1**

- Connections . . . . . 3-3
  - Back Panel Connections . . . . . 3-3
  - Front Panel Indicators . . . . . 3-5
  - Power Up . . . . . 3-5
- Ethernet Communication . . . . . 3-6
  - Overview . . . . . 3-6
  - Twisted Pair . . . . . 3-6
  - Concentrator . . . . . 3-6
  - Node . . . . . 3-7
  - Segment and Branch . . . . . 3-7
  - Repeater . . . . . 3-7
  - Bridge . . . . . 3-8
  - Twisted Pair Cabling (10BaseT) . . . . . 3-8
  - Symbol PC Card (Wireless LAN) . . . . . 3-8

# 4

**MAINTENANCE . . . . . 4-1**

- Maintenance Schedule . . . . . 4-3
  - Manufacturer Recommendations . . . . . 4-3
  - Manufacturer Responsibility . . . . . 4-3
- Visual Inspection . . . . . 4-4
- Cleaning . . . . . 4-5
  - Cleaning Precautions . . . . . 4-5
  - Cleaning the Display . . . . . 4-5
  - Exterior Cleaning . . . . . 4-5
  - Cleaning the Print Head . . . . . 4-6
- Battery Maintenance . . . . . 4-7
  - Charging . . . . . 4-7
  - Conditioning the Batteries . . . . . 4-7
  - Replacing the Batteries . . . . . 4-8
  - Disposal . . . . . 4-8
- Electrical Safety Tests . . . . . 4-9
  - General . . . . . 4-9
  - Recommendations . . . . . 4-9
  - Wall Receptacle Test . . . . . 4-11
  - Ground (Earth) Integrity . . . . . 4-11
  - Ground (Earth) Wire Leakage Current Tests . . . . . 4-13
  - Enclosure Leakage Current Test . . . . . 4-15
  - Patient (Source) Leakage Current Test . . . . . 4-17
  - Patient (Sink) Leakage Current Test  
(Mains Voltage on the Applied Part) . . . . . 4-19
  - Test Completion . . . . . 4-20
  - Hi-Pot (Dielectric Withstand) Test . . . . . 4-21
  - DAS Assembly AC Hi-Pot Test . . . . . 4-22
  - Processor/Power Management PCB Hi-Pot Test . . . . . 4-23
  - AC Mains Hi-Pot Test . . . . . 4-24
- Checkout Procedures . . . . . 4-25
  - Manufacturer Recommended Test Equipment . . . . . 4-25
  - Monitor Power-up Tests . . . . . 4-26
  - ECG Tests . . . . . 4-27

Respiration Tests .....	4-30
Temperature Tests .....	4-31
Cardiac Output Tests .....	4-32
Invasive Blood Pressure Tests .....	4-34
Pulse Oximetry Tests .....	4-36
Noninvasive Blood Pressure Tests .....	4-38
Analog Output and Defibrillator Synchronization Tests .....	4-40
Battery Tests .....	4-43
Graph Test .....	4-43
Graph Speed Test .....	4-43
Display Test .....	4-44
Speaker Test .....	4-44
Network Test .....	4-44
RF LAN Test (option) .....	4-44
RAC 2A Module Housing Test .....	4-45
Completion .....	4-45
PM Form .....	4-45
Repair Log .....	4-46

# 5

<b>TROUBLESHOOTING .....</b>	<b>5-1</b>
Service Menus .....	5-3
Boot Loader Service Menu .....	5-3
Main Menu Service Mode Menu .....	5-4
Review Errors .....	5-8
Error Log Information .....	5-9
Error Logs .....	5-9
Battery Alarms and Messages .....	5-10
Alarm Conditions .....	5-10
Error Message .....	5-11
Power Source Tests .....	5-12
Wall Receptacle .....	5-12
Power Cord and Plug .....	5-13
Data Acquisition Tests .....	5-14
ECG Functions .....	5-14
Lead Fail Functions .....	5-15
Pace Detect Functions .....	5-16
Invasive Blood Pressure Functions .....	5-17
Respiration Functions .....	5-19
Noninvasive Blood Pressure Functions .....	5-21
Wireless LAN Troubleshooting .....	5-22
Service Tips .....	5-24
Fault/Symptom Analysis .....	5-24
Acquisition PCB Symptoms .....	5-25
Processor PCB Symptoms .....	5-25
Troubleshooting Software Updates - Problems and Solutions .....	5-26
Error Messages .....	5-29

# 6

<b>CONFIGURATION</b> .....	<b>6-1</b>
Loading Software .....	6-3
Intended Use .....	6-3
Software Loading/Updating Methods .....	6-3
Software Compatibility .....	6-4
Monitor Software Files .....	6-5
Maintain Patient Monitoring .....	6-5
Problems While Loading Software .....	6-6
Record Defaults .....	6-6
Load Software From Diskette .....	6-7
About the Procedure .....	6-7
Connect the PC to the Monitor .....	6-7
Software Diskettes .....	6-8
Update Program Start-up .....	6-9
Setup Monitor To Accept Download Files .....	6-11
Download Files to the Monitor .....	6-12
Load Software Over The Network .....	6-13
About the Procedure .....	6-13
Network Update Diskettes .....	6-13
Copy Files .....	6-13
Download Files to the Monitor .....	6-15
Complete the Software Download .....	6-17
Activate Software .....	6-17
Configuring a Monitor .....	6-19
General .....	6-19
Main Menu Selections .....	6-21
Set Unit Name .....	6-21
Set Bed Number .....	6-21
Patient-Monitor Type .....	6-22
Set Graph Locations .....	6-23
Admit Menu .....	6-24
Boot Code Selections .....	6-25
Set Defib Sync Voltage and Pulse Width .....	6-25
Set Line Frequency .....	6-25
Set CIC and QS Protocol .....	6-25
Set MUSE Protocol .....	6-26
Transcutaneous Pace Blank Length .....	6-26
Set Country Selection .....	6-27
Wireless LAN .....	6-27
Completion .....	6-27
Advanced User Procedures .....	6-28
Procedures .....	6-28
Set Time and Date .....	6-28
Change Software Level .....	6-29
Change Ethernet Address .....	6-30
Review Errors .....	6-30
Transferring Error Logs .....	6-34
General .....	6-34
Access the COPY LOGS Menu .....	6-35
Select the Care Unit .....	6-35
Select the Monitoring Device .....	6-35

Select the Error Log Date ..... 6-36  
 Copy Error Logs ..... 6-36  
 Eject Floppy ..... 6-36

# 7

**CALIBRATION ..... 7-1**  
 Hardware Calibration ..... 7-3  
 NBP, ECG, BP, and End-tidal CO2 Software Calibration ..... 7-4  
     NBP Calibration ..... 7-4  
     ECG or BP Calibration ..... 7-7  
     End-tidal CO2 Calibration ..... 7-8

# 8

**FIELD REPLACEABLE UNITS AND UPGRADES ..... 8-1**  
 Disassembly Guidelines ..... 8-3  
     Tools Required ..... 8-3  
     Before Disassembly ..... 8-3  
     Hardware Assemblies ..... 8-3  
     PCB Assemblies ..... 8-3  
     After Reassembly ..... 8-5  
 Handle Assembly ..... 8-7  
     Removing the Handle Assembly ..... 8-7  
     Replacing or Upgrading the Dash 3000 Alarm Light Option ..... 8-8  
 Display Assembly Components ..... 8-9  
     Removing the Display Assembly from the Main Unit ..... 8-9  
     Replacing the Backlight Inverter PCB ..... 8-13  
     Replacing the Key Pad Assembly ..... 8-14  
     Replacing the LCD Color Display ..... 8-15  
     Replacing or Upgrading the Dash 4000 Alarm Light Option ..... 8-16  
     Replacing the Dash 4000 Front Panel PCB ..... 8-17  
     ..... 8-17  
 Main Unit Components ..... 8-18  
     DAS and NBP Assemblies ..... 8-18  
     Main and/or Power Supply Assemblies, Speaker or  
         RF LAN Upgrade ..... 8-21  
         Processor/Power Management PCB and Battery Assembly ..... 8-22  
         Power Supply Assembly ..... 8-24  
         Speaker ..... 8-25  
         RF LAN Upgrade Instructions ..... 8-26  
 Optional DDW Writer Replacement/Upgrade ..... 8-36  
     Replacement ..... 8-36  
     Upgrade ..... 8-36

# 9

**ASSEMBLY DRAWINGS ..... 9-1**

- Introduction ..... 9-3
- Theory Of Operation ..... 9-4
  - General Monitor Block Theory ..... 9-4
  - Components ..... 9-5
  - Overall Monitor Block Diagram ..... 9-5
  - User Interface ..... 9-6
  - Power Supply ..... 9-8
  - Data Acquisition System (DAS) ..... 9-8
  - Processor/Power Management Subsystem ..... 9-13
  - Optional Thermal Printer ..... 9-20
  - Speaker ..... 9-20
  - Handle Subassembly ..... 9-20
  - Interfaces ..... 9-20
  - Setup and Configuration ..... 9-21
- Electrical Diagram ..... 9-22
- Dash 3000 Exploded Views, PN 420000-xxx ..... 9-23
- Dash 3000 Display Bezel Assembly, PN 419031-001 ..... 9-28
- Dash 3000 Display Bezel Parts List, PN 419031-001 ..... 9-29
- Dash 3000 Display Bezel Part List , PN 419031-003 ..... 9-31
- Dash 4000 Parts List PN 2004323-xxx ..... 9-34
- Dash 4000 Display Assembly, PN 2004272-001 ..... 9-36
- Dash 4000 Display Bezel Parts List, PN 2004272-001 ..... 9-37
- Field Replaceable Units (FRU's) ..... 9-38
  - Dash 3000 FRUs ..... 9-38
  - Dash 4000 FRUs ..... 9-38
- Port Connections ..... 9-40
  - Invasive Blood Pressure Cable Connector ..... 9-40
  - Pulse Oximetry (SpO2) Cable Connector ..... 9-41
  - Temperature/CO Cable Connector ..... 9-41
  - Capnostat III (CO2) Cable Connector ..... 9-42
  - NBP Connector ..... 9-43
  - ECG Cable Connector ..... 9-43
  - Input Power Requirements ..... 9-44
  - Network Interface ..... 9-44
  - Auxiliary Communication ..... 9-45
  - Defib Sync ..... 9-45
  - Peripheral Expansion Interface ..... 9-46



# 1 INTRODUCTION

INTRODUCTION:

---

*For your notes*

# Manual Information

## Revision History

Each page of this manual has the document part number and revision letter at the bottom of the page. The revision letter identifies the document's update level. The revision history of this document is summarized below.

<b>Revision History</b>		
<b>Revision</b>	<b>Date</b>	<b>Comment</b>
A	27 November 2000	Initial release of this manual.

## Manual Purpose

This manual supplies technical information for service representatives and technical personnel so they can maintain the equipment to the assembly level. Use it as a guide for maintenance and electrical repairs considered field repairable. Where necessary the manual identifies additional sources of relevant information and technical assistance.

See the operator's manual for the instructions necessary to operate the equipment safely in accordance with its function and intended use.

## Intended Audience

This manual is intended for service representatives and technical personnel who maintain, troubleshoot, or repair this equipment.

# Safety Information

## Responsibility of the Manufacturer

GE Medical Systems *Information Technologies* is responsible for the effects of safety, reliability, and performance only if:

- Assembly operations, extensions, readjustments, modifications, or repairs are carried out by persons authorized by GE Medical Systems *Information Technologies*.
- The electrical installation of the relevant room complies with the requirements of the appropriate regulations.
- The equipment is used in accordance with the instructions for use.

## General

This device is intended for use under the direct supervision of a licensed health care practitioner.

This device is not intended for home use.

Federal law restricts this device to be sold by or on the order of a physician.

Contact GE Medical Systems *Information Technologies* for information before connecting any devices to the equipment that are not recommended in this manual.

Parts and accessories used must meet the requirements of the applicable IEC 601 series safety standards, and/or the system configuration must meet the requirements of the IEC 60601-1-1 medical electrical systems standard.

Periodically, and whenever the integrity of the device is in doubt, test all functions.

The use of ACCESSORY equipment not complying with the equivalent safety requirements of this equipment may lead to a reduced level of safety of the resulting system. Consideration relating to the choice shall include:

- use of the accessory in the PATIENT VICINITY; and
- evidence that the safety certification of the ACCESSORY has been performed in accordance to the appropriate IEC 60601-1 and/or IEC 60601-1-1 harmonized national standard.

If the installation of the equipment, in the USA, will use 240V rather than 120V, the source must be a center-tapped, 240V, single-phase circuit.

## Warnings, Cautions, and Notes

The terms danger, warning, and caution are used throughout this manual to point out hazards and to designate a degree or level or seriousness. Familiarize yourself with their definitions and significance.

Hazard is defined as a source of potential injury to a person.

**DANGER** indicates an imminent hazard which, if not avoided, will result in death or serious injury.

**WARNING** indicates a potential hazard or unsafe practice which, if not avoided, could result in death or serious injury.

**CAUTION** indicates a potential hazard or unsafe practice which, if not avoided, could result in minor personal injury or product/property damage.

**NOTE** provides application tips or other useful information to assure that you get the most from your equipment.

## Equipment Symbols

Some of the following symbols appear on the equipment.



**ATTENTION:** Consult accompanying documents before using the equipment.

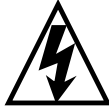

In Europe, this symbol means dangerous or high voltage. In the United States, this symbol represents the caution notice below:

To reduce the risk of electric shock, do **NOT** remove cover (or back). Refer servicing to qualified personnel.



Defibrillator-proof type CF equipment; type CF equipment is specifically designed for applications where a conductive connection directly to the heart is established. The paddles indicate the equipment is defibrillator proof.



Defibrillator-proof type BF equipment; type BF equipment is suitable for intentional external and internal application to the patient, excluding direct cardiac application. Type BF equipment is type B equipment with an F-type isolated (floating) part. The paddles indicate the equipment is defibrillator proof.



Type B equipment; type B equipment is suitable for intentional external and internal application to the patient, excluding direct cardiac application.



Equipotentiality



Alternating current (AC)

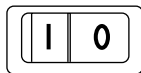

Power; **I** = ON; **O** = OFF

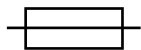

Fuse

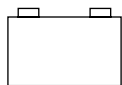

Battery

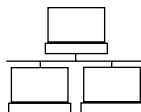

Indicates the Ethernet connection for the monitor.

**PRESS**



Press to open.



814A

**Power**



815A

**Graph Go/Stop**



816A

**NBP Go/Stop**



817A

**Function**



818A

**Silence Alarm**



Classified by Underwriters Laboratories Inc. with respect to electric shock, fire, mechanical and other specified hazards, only in accordance with UL 2601-1, CAN/CSA C22.2 No. 601.1, IEC 60601-1, and, if required, IEC 60601-2-27, IEC 60601-2-30, IEC 60601-2-34, IEC 60601-1-1.

# Service Information

## Service Requirements

Follow the service requirements listed below.

- Refer equipment servicing to GE Medical Systems *Information Technologies*' authorized service personnel only.
- Any unauthorized attempt to repair equipment under warranty voids that warranty.
- It is the user's responsibility to report the need for service to GE Medical Systems *Information Technologies* or to one of their authorized agents.
- Failure on the part of the responsible individual, hospital, or institution using this equipment to implement a satisfactory maintenance schedule may cause undue equipment failure and possible health hazards.
- Regular maintenance, irrespective of usage, is essential to ensure that the equipment will always be functional when required.

## Equipment Identification

Every GE Medical Systems *Information Technologies* device has a unique serial number for identification. A sample of the information found on a serial number label is shown below.

**D 0 XX 0005 G XX**

**Month  
Manufactured**

A = January  
 B = February  
 C = March  
 D = April  
 E = May  
 F = June  
 G = July  
 H = August  
 J = September  
 K = October  
 L = November  
 M = December

**Year  
Manufactured**

0 = 2000  
 1 = 2001  
 2 = 2002  
**(and so on)**

**Product Code**

Two-character product descriptor

**Product  
Sequence  
Number**

Manufacturing number (of total units manufactured)

**Division**

F = Cardiology  
 G = Monitoring

**Device Characteristics**

One or two letters that further describe the unit, for example:  
 P = prototype not conforming to marketing specification  
 R = refurbished equipment  
 S = special product documented under Specials part numbers  
 U = upgraded unit



# 2 EQUIPMENT OVERVIEW

*For your notes*

# Components

## The Monitoring System

The Dash 3000/4000 patient monitor can function by itself with a built-in writer, or it can be cabled in with the Unity Network via Ethernet. Optional components are, if using Wireless LAN or cabled to Ethernet, a Centralscope central station and the Clinical Information Center.

## The Patient Monitor

This device is designed to monitor a fixed set of parameters including ECG, noninvasive blood pressure, impedance respiration, SpO<sub>2</sub>, and temperature. Invasive pressure and EtCO<sub>2</sub> are optional features. Additional specialized features include cardiac output, cardiac calculations, pulmonary calculations, dose calculations, PA wedge (PA wedge is only available with the invasive pressure option), and SAM module interface.



Dash 3000 Monitor

001A



Dash 4000 Monitor

051A

## Right Side View

All of the patient cable connectors are located on the right side of the monitor. A Trim Knob control provides single control operation of virtually all monitor functions.

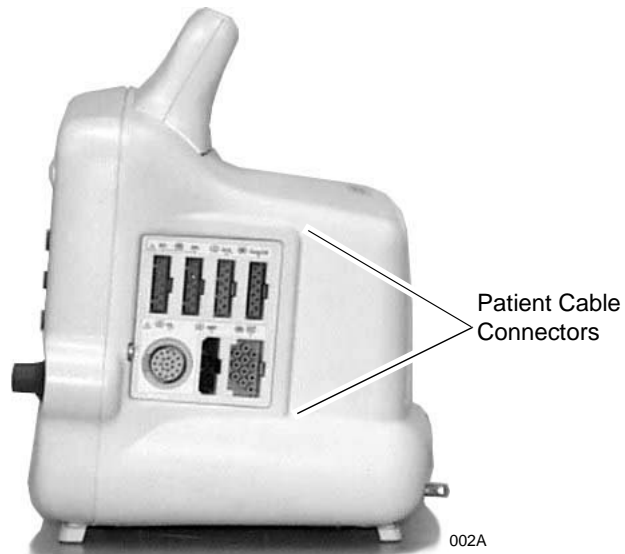

## Left Side View

On the left of the monitor, you can find the built-in writer and the battery compartment.

Optional Built-in Writer—  
The built-in, 4 channel  
writer is located in the  
center of the left side of the  
monitor.

Battery Compartment—  
The battery packs are  
located in this  
compartment.

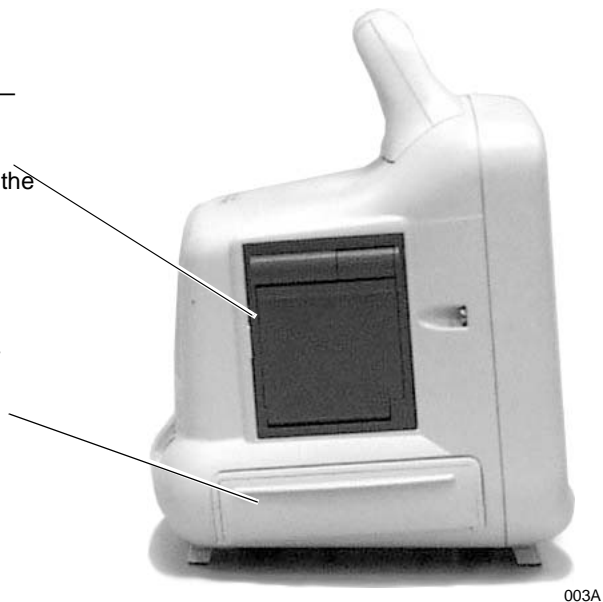

## Back View

On the back of the monitor you will find all connectors for equipment and network.

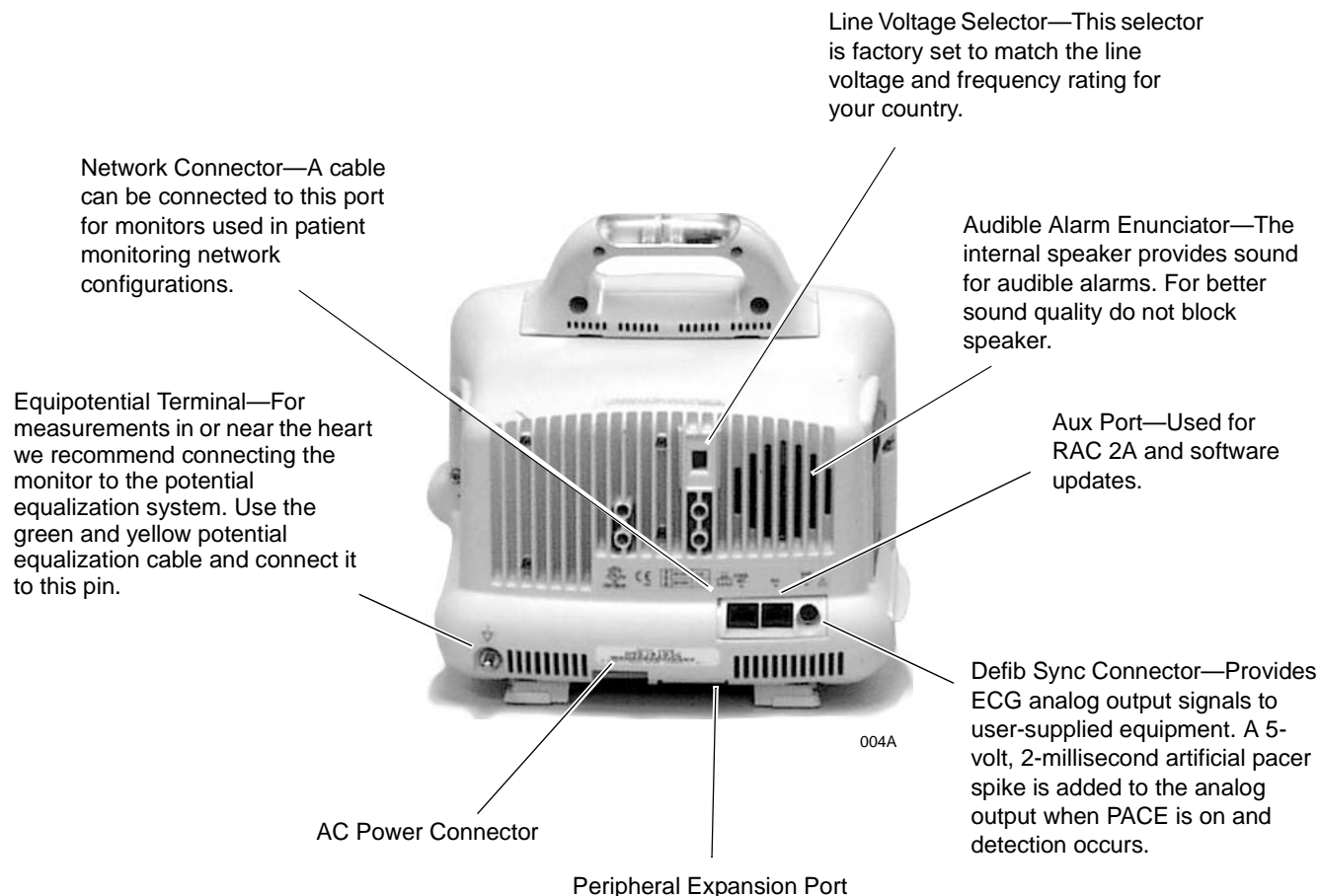

## Optional Alarm Indicator

An optional alarm indicator can be built into the handle of the Dash 3000 monitor or into the display bezel of the Dash 4000 monitor. When activated, the LED indicator flashes red for CRISIS and WARNING patient status alarms and yellow for all other alarms.

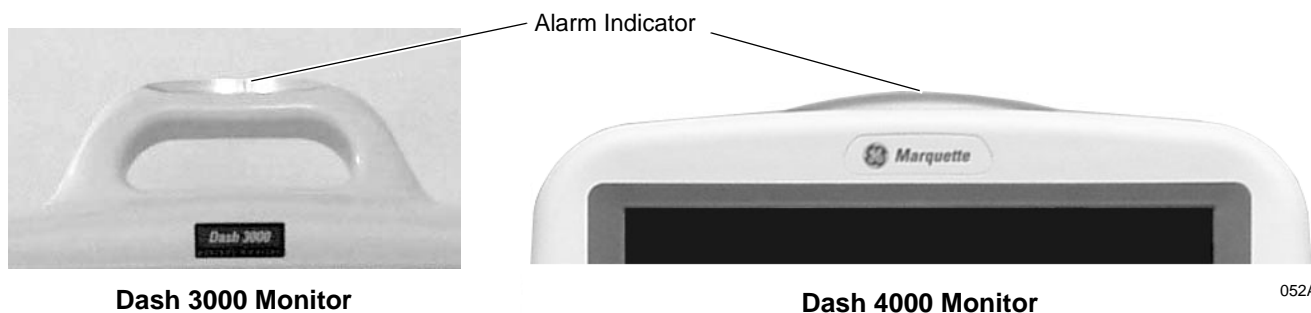

## Optional RAC 2A Module Housing

The RAC 2A module housing currently supports the SAM module.



006A

An integral power supply is used to run the RAC 2A and support the needed voltages.

## Optional Wireless LAN System

The flexibility of the GE Medical Systems *Information Technologies* Unity Network is increased by using the Wireless LAN system. The Wireless LAN system allows the user to roam from one access point to another, maintaining a strong, seamless connection to the Unity network.

The monitor, with its optional built-in Wireless LAN, functionally performs the same as a monitor connected directly to the Unity network. It can be viewed at the central station and by other GE Medical Systems *Information Technologies*' monitors on the network (i.e. Dash 3000/4000, Eagle 4000, and Solar patient monitors). Monitors with Wireless LAN sends and receives patient data via the access points of the Unity network.

**NOTE:** Wireless patient monitors that are moved from room to room must have the monitor type configured as Rover or Rover/Combo monitoring.

## Access Points

To integrate the wireless network with the wired network, one or more access points are necessary. An access point connects the wireless monitor to the wired network infrastructure within the building, and acts as a bridge between the wired and wireless networks. The areas covered by each access point overlap to insure continuous coverage.

**NOTE:** The monitor will only work with a Symbol Access Point. The monitor will not communicate directly with a Wireless LAN device from Aironet.



# Technical Specifications

Due to continual product innovation, specifications are subject to change without notice. The following specifications are accurate as of the date of this publication, and pertain to the Dash 3000/4000 Patient Monitor.

## Performance Specifications

### Display

Size:	Dash 3000: 8.4-inch diagonal Dash 4000: 10.4-inch diagonal
Type: Color:	Active-Matrix Liquid Crystal Display (LCD)
Resolution:	640 by 480 pixels
Number of traces:	6 (maximum)
Number of seconds/trace:	Dash 3000: 4.9 at 25 mm/sec Dash 4000: 5.9 at 25 mm/sec
Sweep speed: All waveforms	6.25, 12.5 or 25 mm/sec (with erase bar)
Waveform display options:	Individual 6 waveforms, individual 3 waveforms, full, and full grid modes
Information window:	Displays non-real-time information without obstructing the display of real-time information
Display organization:	Prioritized by parameter

### Controls

Standard:	Trim Knob control plus 5 hard keys: Power, NBP Go/Stop, Function, Silence Alarm, and Graph Go/Stop
-----------	--

### Alarms

Categories:	Patient Status and System Status
Priorities:	4 levels — Crisis, Warning, Advisory, and Message
Notification:	Audible and visual
Setting:	Default and individual
Silencing:	1 minute, current alarm only



Pause:	5 minutes (adult); 3 minutes (neonatal); 5, 15 minutes, permanent (OR mode)
Volume:	Default 70%, 70 dB measured at 1 meter

## ECG

5 Leadwire cable:	I, II, III, V, aVR, aVL, and aVF
10 Leadwire cable (12SL option):	V2, V3, V4, V5 and V6
Leads analyzed simultaneously:	I, II, III, and V (multi-lead mode)
Lead fail:	Identifies failed lead
Alarms:	User-selectable upper and lower heart rate limits
Input specifications: Voltage range: Signal width: Heart rate range: Accuracy: Input impedance: Common mode: Differential: Common mode rejection:	 $\pm 0.5$ mV to $\pm 5$ mV 40 ms to 120 ms (Q to S) 30 to 300 BPM $\pm 1\%$ or $\pm 1$ BPM, whichever is greater  >10 M $\Omega$ at 50/60 Hz >2.5 M $\Omega$ from dc to 60 Hz 90dB minimum at 50 Hz or 60 Hz
Output specifications: Frequency response: Display: Diagnostic: Monitoring: Moderate: Maximum: Paper Recorder: Diagnostic: Monitoring: Moderate: Maximum: Linearity deviation: Noise:	   0.05 to 40 Hz 0.05 to 40 Hz 0.05 to 25 Hz 5 to 25 Hz  0.05 to 100 Hz 0.05 to 40 Hz 0.05 to 25 Hz 5 to 25 Hz $\pm 3\%$ (maximum) <30 $\mu$ V (referred to input)
ST segment measurement: Measurement point: Measurement range: Measurement accuracy:	 Adjustable from 0 to 120 ms past the J-point (default: 60 ms adult, 30 ms neonatal) -12.0 to +12.0 mm $\pm 10\%$ or 0.5 mm, whichever is greater
Pacemaker detection/rejection: Input voltage range: Input pulse width: Rise time: Over/under shoot: Baseline drift:	 $\pm 2$ mV to $\pm 700$ mV 0.1 ms to 2 ms 10 $\mu$ s to 100 $\mu$ s 2 mV (max) <0.5 mV/hour with a $\pm 700$ -mV, 2-ms pacemaker pulse applied

## Invasive Blood Pressure (BP)

Number of channels:	2
Transducer sites:	Arterial (ART), femoral artery (FEM), pulmonary artery (PA), central venous (CVP), right atrial (RA), left atrial (LA), intracranial (ICP), and special (SP)  In neonatal mode: umbilical artery catheter (UAC) and umbilical venous catheter (UVC)
Transducer requirements: Excitation voltage: Transducer output:	5.0 Vdc $\pm$ 0.1% 5 $\mu$ V/mmHg
Input specifications: Range: Offset:	-25 mmHg to 300 mmHg $\pm$ 150 mmHg
Output specifications: Frequency response: Zero balance range: Zero balance accuracy: Zero balance drift: Accuracy:  Alarms:	dc to 50 Hz $\pm$ 150 mmHg $\pm$ 1 mmHg $\pm$ 1 mmHg over 24 hours $\pm$ 2% or $\pm$ 1 mmHg, whichever is greater (exclusive of transducer)  User-selectable upper and lower limits for systolic, diastolic, and mean pressures

## Noninvasive Blood Pressure (NBP)

Measurement technique:	Oscillometric
Displayed parameters:	Systolic, diastolic, and mean pressures, pulse rate, time of last measurement
Measurement modes:	Manual, auto, and stat in adult and OR modes; manual and auto in neonatal mode
NBP pressure range: Systolic pressure range Adult: Pediatric: Neonatal: Diastolic pressure range Adult: Pediatric: Neonatal: Mean pressure range Adult: Pediatric: Neonatal:	30 to 275 mmHg 30 to 235 mmHg 30 to 135 mmHg 10 to 220 mmHg 10 to 220 mmHg 10 to 110 mmHg 20 to 260 mmHg 20 to 260 mmHg 20 to 125 mmHg
Cuff pressure range: Adult: Pediatric: Neonatal:	0 to 275 mmHg 0 to 235 mmHg 0 to 135 mmHg
Pressure accuracy: Static: Clinical:	$\pm 2\%$ or $\pm 3$ mmHg, whichever is greater $\pm 5$ mmHg average error 8 mmHg standard deviation
Heart rate detection:	30 to 200 beats per minute
Total cycle time:	20 to 40 seconds typical (dependent on heart rate and motion artifact)
Automatic cycle times:	0 to 8 hours
Auto zero:	Zero pressure reference prior to each cuff inflation
Tubing length: Adult: Neonatal:	12 feet 8 feet
Automatic cuff deflation:	Cycle time exceeding 3 minutes (90 seconds neonatal), power off, or cuff pressure exceeds 294 mmHg ( $\pm 6$ mmHg) adult, 147 mmHg ( $\pm 3$ mmHg) neonatal
Cuff sizes: Disposable: Reusable:	Large adult, adult, small adult, pediatric, small pediatric, and infant Thigh, large adult, adult, child, and infant
Alarms:	User-selectable upper and lower limits for systolic, diastolic, and mean pressures

## Pulse Oximetry (SPO2)

Parameters monitored:	Arterial oxygen saturation (SpO2) and peripheral pulse rate (PPR)
SpO2 range:	50 - 100%
PPR range:	30 - 300 beats per minute
Accuracy: SpO2: PPR:	Actual accuracy depends on probe. Please reference manufacturer's specifications. ± 2% (70 - 100% SpO2) ±1 standard deviation ± 3% (50 - 69% SpO2) ±1 standard deviation ± 3 beats per minute
Alarms:	User-selectable upper and lower limits for SpO2 and PPR

## Cardiac Output (CO)

Availability:	Included in 7020 and 7025 software packages. Not available in 7015 software package.
Input specifications: Probe type: Catheter manufacturers: Catheter sizes: Abbott catheter sizes: Arrow catheter sizes: Baxter catheter sizes: Ohmeda catheter sizes: Other catheter sizes: Injectate volume:	In-line or bath probe Abbott, Arrow, Baxter, Ohmeda, or other 5.5F (75 cm), 7F (85 cm), 7.5F (110 cm), and 8F (110 cm) 5, 6, 7, or 7.5F 5, 6, 7, 7.5 or 8F 5, 7, or 7.5F Cardiac coefficient entered manually 3, 5, or 10 cc
Output specifications: Parameters displayed: Range: Cardiac output: Blood temperature: Injectate temperature: Accuracy: Cardiac output: Blood temperature: Injectate temperature: Frequency response:	Cardiac output, blood temperature, injectate temperature, trial number 0.2 - 15 liters per minute 30 - 42°C 0 - 30°C ±5% (liters of blood/min) ±0.2°C ±0.3°C dc to 15 Hz ±2 Hz

## Respiration

Measurement technique:	Impedance variation detection
Range: Respiration rate: Base impedance: Detection sensitivity:	0 - 200 breaths per minute 100 - 1000 $\Omega$ at 52.6 kHz excitation frequency 0.4 to 10 $\Omega$ variation
Accuracy: Respiration rate	$\pm 1$ BrPM
Waveform display bandwidth:	0.1 to 1.8 Hz ( $-3$ dB)
Alarms:	User-selectable upper and lower respiration rate limits, and user-selectable apnea limit

## Temperature (TEMP)

Number of channels:	2
Input specifications: Probe type: Temperature range: Resolution:	YSI Series 400 or 700 thermistor (determined by input cable) 0°C to 45°C (32°F to 113°F) $\pm 0.1^\circ\text{C}$
Output specifications: Parameters displayed: Accuracy: Alarms:	T1, T2 (independent of source) $\pm 0.1^\circ\text{C}$ for YSI series 400 probes; $\pm 0.3^\circ\text{C}$ for YSI series 700 probes User-selectable upper and lower limits for T1, T2

## Carbon Dioxide (CO2)

Information displayed:	Inspired and expired carbon dioxide concentrations in %, mmHg or kPa, respiration rate, continuous CO2 waveform
Measurement technique:	Non-dispersive infrared absorption, dual wavelength ratiometric
Sensor type:	Novamatrix Medical Systems' Capnostat III
Patient interface:	Compatible with Novamatrix Medical Systems' Capnogard monitoring product
Airway adaptors Types: Dead space/chamber volumes: Adult reusable: Adult disposable: Neonatal:	Adult reusable (standard), adult disposable, neonatal   <5 cc <5 cc <0.5 cc

EQUIPMENT OVERVIEW: Technical Specifications

CO2 measurement specifications:	
Measurement range:	
Pi CO2/Fi CO2:	0 to 100 mmHg/0 to 13%
Pe CO2/Fe CO2:	0 to 100 mmHg/0 to 13%
RR:	0 to 120 breaths/min
Accuracy:	±5% of reading or ±2 mmHg, whichever is greater
Display update interval:	2 sec
CO2 waveform sweep speed:	Selectable 6.25, 12.5, or 25 mm/sec
CO2 averaging:	Selectable from single breath, 10 sec, or 20 sec
CO2 measurement stability:	Accuracy maintained over 8 hours
Resolution:	1 mmHg
Noise:	2% of reading or 0.5 mmHg (maximum), whichever is greater
60 Hz interference:	<0.5 mmHg at 38 mmHg
Step response time:	
Adult:	<60 ms (10-90%)
Neonatal:	<50 ms (10-90%)
Interference:	
N2O gas:	±5% of reading or ±2 mmHg (maximum), whichever is greater, with N2O compensation enabled
O2 gas:	±5% of reading or ±2 mmHg (maximum), whichever is greater, with O2 compensation enabled
Barometric pressure:	±2 mmHg (maximum) from 500 to 800 mmHg
Water vapor:	±1.5% of reading or ±0.5 mmHg (maximum), whichever is greater
Anesthetic agent:	±0.5 mmHg (maximum) for concentration of no more than 5% of halogenated agents
Airway adapter variability:	±3% of reading or ±1.5 mmHg (maximum), whichever is greater, with same or different adapter; not applicable after adapter zero
Warm-up time:	Less than 15 seconds to initial CO2 indication, full specification within 120 seconds; waveform immediate upon power up
Calibration:	
Factory settings:	Factory calibration settings stored in nonvolatile memory within the sensor; 15 second adaptor calibration when switching airway types
Verification:	Zero and span performance check with on-cable verifier
Respiration rate specifications:	
Range (for 5% step size):	0-120 breaths per minute
Accuracy:	±1 breath per minute
Resolution:	±1 breath per minute
Barometric pressure sensor specifications:	
Range:	425 to 817 mmHg (56 to 109 kPa)
Accuracy:	±25 mmHg
Alarms:	User-selectable upper and lower limits for CO2 and RR.

## Analog Output

ECG: Gain: DC offset: Noise: Frequency response: Time delay:	1 V/mV $\pm 10\%$ $\pm 100$ mV (max) $< 5$ mVp-p (0-300 Hz) 0.05 Hz to 100 Hz +7/-0 Hz 40 ms monitoring filter, 35 ms diagnostic filter
Blood pressure: Gain: DC offset: Noise: Frequency response: Time delay:	10 mV/mmHg $\pm 2\%$ $\pm 20$ mV (max) $< 5$ mVp-p (0-300 Hz) dc to 50 Hz +2/-0 Hz 40 Hz filter, 37 ms

## Defibrillator Synchronization Pulse

Marker out: Time delay:  Amplitude (selectable in Service menu): +5 V selection: +12 V selection:  Pulse width:  Output impedance: Current limit:	35 ms (maximum), R-wave peak to leading edge of pulse.  3.5 V (min) at 1 mA sourcing; 0.5 V (max) at 5 mA sinking. 11.0 V (min) at 1 mA sourcing; 0.75 V (max) at 5 mA sinking.  10 ms $\pm 10\%$ or 100 ms $\pm 10\%$ (selectable in Service menu).  50 $\Omega$ nominal 15 mA nominal, both sourcing and sinking.
Marker in: Input threshold: Input hysteresis: Maximum input voltage: Input impedance: Pulse width:	$V_{IH} = \pm 2.5$ V (min); $V_{IL} = \pm 1.5$ V (max) 650 mV typical $\pm 30$ V (with respect to ground on pin 3) 10 k $\Omega$ (min) for $-25$ V $< V_{IN} < 25$ V 1.0 ms (min), $V_{IN} > 2.5$ V

## Battery

Battery type:	Exchangeable Lithium-Ion
Number of batteries:	2
Battery weight:	0.36 kg (0.8 lbs) each
Voltage:	11.1 V (nominal)
Capacity:	3.9 Ah
Charge time:	Less than 4 hours each
Run time:	4 to 5 hrs

## Paper Recorder

Method:	Thermal dot array
Horizontal resolution:	480 dots/in at 25 mm/sec
Vertical resolution:	200 dots/in
Number of waveform channels:	4
Paper width:	50 mm (1.97 in)
Paper length:	30 m (100 ft)
Paper speed:	0.1, 0.5, 1, 5, 10, 12.5, 25, and 50 mm/sec ( $\pm 2\%$ )

## RF Wireless LAN

Transmission technique:	Frequency hopping spread spectrum
Frequency:	Country dependent, specific settings received from access point. Within 2400 to 2500 MHz range.
Frequency hopping characteristics:	Country dependent, specific settings received from access point. IEEE 802.11 compliant
Radio data rate:	1 and 2 Mbps
Radio output power:	160 mW (including antenna gain)
1 Mbps range:	Open environment: over 850 ft. (260) Typical hospital environment: between 150 and 200 ft. (45 to 60 m)
2 Mbps range:	Open environment: over 425 ft. (130) Typical hospital environment: between 100 and 150 ft. (30 to 45 m)
Modulation:	Binary GFSK
Applicable standards:	US: FCC Part 15 Class B Europe: ETS 300 328 and ETS 300 826



## Environmental Specifications

NOTE: The system may not meet its performance specifications if stored or used outside the manufacturer's specified temperature and humidity range.	
Power requirements: 90-132VAC 190-264 VAC	50/60 Hz 2.0A 50/60 Hz 1.0A
Power consumption:	75 watts (fully loaded)
Cooling:	Convection
Heat dissipation:	240 Btu/hr (max)
Battery operation time: General:	Battery age will affect operating time.
Operating conditions: Ambient temperature: While charging batteries: Capnostat III sensor Relative humidity: Vibration: Altitude:	0 to 40°C (32 to 104°F) 0 to 35°C (32 to 95°F) 10° to 40° C (50° to 104°F) 5 to 95% at 40°C MIL-STD 810E, Method 514.4, Category 1 -610 to 4, 570 m (-2,000 to 15,000 ft)
Storage conditions (Do not exceed): Maximum: Minimum: CO2 Sensor: Batteries:	70°C (158°F) at 95% relative humidity -40°C (-40°F) at 15% relative humidity -30 to 65°C (-22 to 149°F) -20 to 60°C (-4 to 140°F)
Equipment Type:	Portable per IEC 60601-1

## Physical Specifications

Height:	Dash 3000 Dash 4000	26 cm (10.25 inches) 27.38 cm (10.78 inches)
Width:	Dash 3000 Dash 4000	28 cm (11.0 inches) 29.26 cm (11.5 inches)
Depth:	Dash 3000 Dash 4000	20 cm (8 inches) 24.26 cm (9.55 inches)
Weight (without batteries)	Dash 3000 Dash 4000	5.08 kg (11.2 lbs) 5.53 kg (12.2 lbs)

## Certification

### Safety

UL 2601-1 classified.
UL classified for CAN/CSA C22.2 No. 601.1
IEC 60601-1 and EN 60601-1 Certified
CE marking for Council Directive 93/42/EEC concerning medical devices
Radio and Telecommunication Terminal Equipment Directive

### Electromagnetic Compatibility Compliance (EMC)

The Dash 3000/4000 system meets the requirements of EN 60601-1-2 (1993–04) Medical Electrical Equipment, Part 1: General Requirements for Safety, 2. Collateral Standard: Electromagnetic compatibility—Requirements and tests.

#### Exceptions

**SpO<sub>2</sub> Parameter** — EN 60601-1-2 clause 36.202.1—IMMUNITY:  
Radiated Immunity:

- The level of compliance is 1 volt per meter. If operating under the conditions defined in EMC Standard EN60601-1-2 (Radiated Immunity 3 volts per meter), field strength above 1 volt per meter may cause waveform distortions and erroneous numeric data at various electromagnetic interference (EMI) frequencies.

**CO<sub>2</sub> Parameter** — EN 60601-1-2 clause 36.202.1—IMMUNITY:  
Radiated Immunity:

- The level of compliance is 1 volt per meter. If operating under the conditions defined in EMC Standard EN60601-1-2 (Radiated Immunity 3 volts per meter), field strength above 1 volt per meter may cause waveform distortions and erroneous numeric data at various electromagnetic interference (EMI) frequencies.

#### Recommendations

Review the AAMI EMC Committee technical information report (TIR-18) titled Guidance on electromagnetic compatibility of medical devices for clinical/biomedical engineers - Part 1: Radiated radio-frequency electromagnetic energy. This TIR provides a means to evaluate and manage the EMI environment in the hospital.

The following actions can be taken:

- managing (increasing) distance between sources of EMI and susceptible devices.
- managing (removing) devices that are highly susceptible to EMI
- lower power from internal EMI sources under hospital control (i.e. paging systems)
- labeling devices susceptible to EMI
- educate staff (nurses and doctors) to be aware of, and to recognize,

potential EMI related problems

## Warranty

Standard:	One year. Other options are available. Contact your sales representative for more information.
-----------	--



# 3 INSTALLATION

INSTALLATION:

---

*For your notes*

# Connections

## Back Panel Connections

On the back of the monitor you will find all connectors for equipment and network.

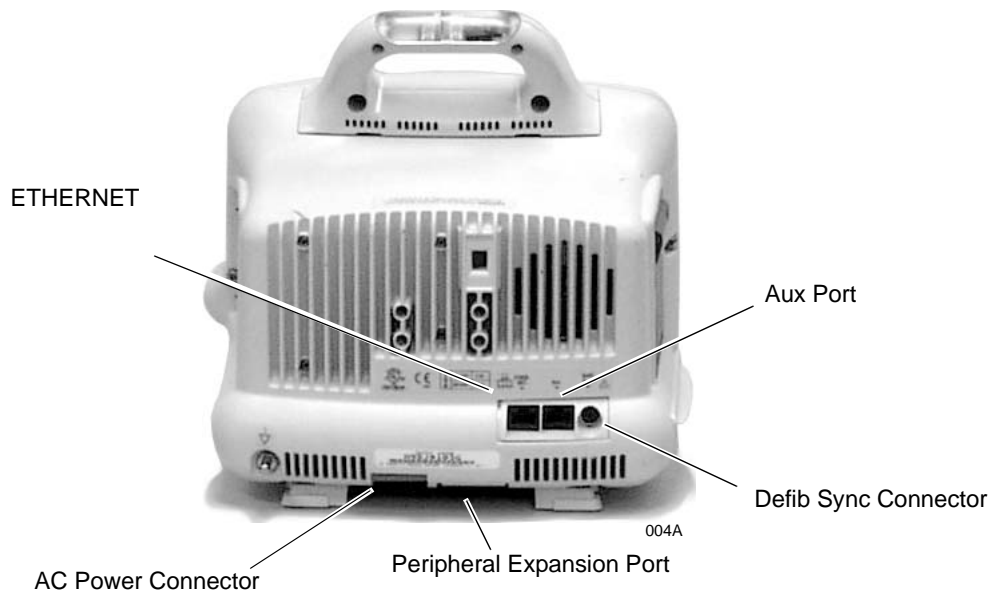

## ETHERNET

The **ETHERNET** connector provides an ANSI/IEEE 802.3 10BaseT Ethernet standard interface to the Unity Network.

## RAC 2A Housing Connectors

The RAC 2A module housing connects to the monitor via a standard category 5 patch cable (PN 418335-002) which plugs into the AUX port on the monitor and to the Auto Port on the back of the RAC 2A module housing.

The RAC 2A module housing does not have an Analog Output connector.

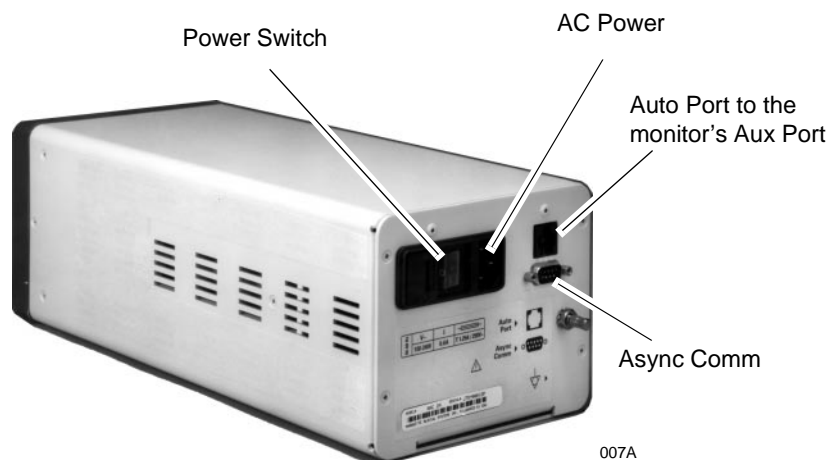

## Defib Sync

The connector provides ECG analog output signals to user-supplied equipment.

---

---

**CAUTION**

Equipment damage. Connect all peripheral equipment before plugging the power cord into an AC outlet. Otherwise, connectors may be damaged.

---

---

## AC Power

Use this connector to apply power to the monitor. The monitor will be powered at all times when using AC power (there is no AC power switch). The monitor is preset at the factory for a specific AC voltage. Before applying power, be sure the power requirements match your power supply. Refer to the label on the back of the unit for the voltage and current requirements.



## Front Panel Indicators

Power and battery indicators are located on the front panel of the monitor.

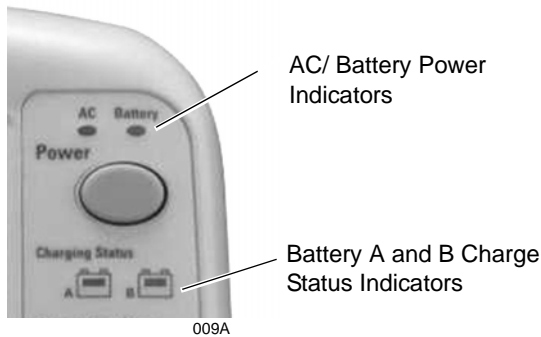

**Dash 3000 Monitor's Front Panel**

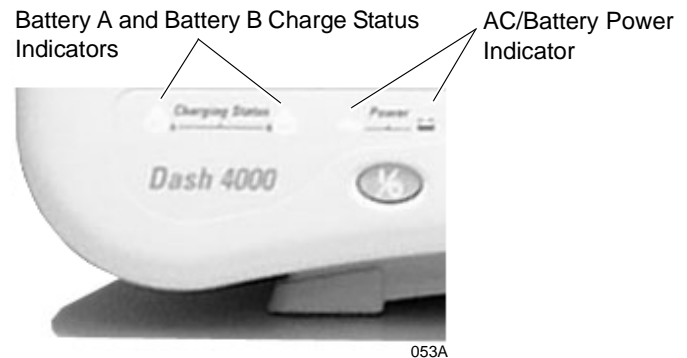

**Dash 4000 Monitor's Front Panel**

### AC Power Indicator

The indicator illuminates green when AC power is applied to the monitor. The indicator is not illuminated when the monitor is not powered.

### Battery Power Indicator

The indicator illuminates yellow when the monitor is battery powered. The indicator is not illuminated when the monitor is not powered or when AC power is applied.

### Battery Charging/Ready Indicators

An icon for each battery pack indicates its charging status. The battery icon illuminates yellow when the respective battery is being charged. If both batteries are present and require charging, then both icons will illuminate even though they will be charged sequentially. The battery icon illuminates green when the respective battery is fully charged.

When the monitor is operating under battery power the battery icons will not be illuminated. The icons are also not illuminated when the respective battery is either not being charged, not installed, or has failed.

---



---

#### **NOTE**

No specific information is given to distinguish a failed battery pack condition from a condition where the battery is not installed or is not being charged.

---



---

## Power Up

After making all connections, plug the power cord into an AC wall outlet.

When all cables are properly connected, press the power button to turn the monitor on. All four front panel indicators will illuminate until the power-up sequence is complete. After approximately 10 seconds you should see a display on the screen.

# Ethernet Communication

## Overview

Ethernet is a local area network used as the main link of the GE Medical Systems *Information Technologies*' Unity network, a comprehensive information communication system. The Unity network offers the high rate of communication of 10 megabits per second. The Ethernet connector connects to an Ethernet transceiver directly or via a transceiver cable. This local area network links all patient monitors, central stations, and other GE Medical Systems *Information Technologies*' equipment throughout the hospital. Depending on the construction of the hospital, thick-net, thin-net, or twisted pair cabling is used.

## Twisted Pair

Twisted pair is the most popular cabling because it is easy to install and flexible to work with. It uses the star topology with a concentrator as the hub of the segment. Each of the network devices is connected directly to the concentrator so longer lengths of cable are required. A maximum of 100 meters or 328 feet is the longest length of twisted pair cable used. The number of devices is limited to the amount of connectors at the concentrator.

## Concentrator

The concentrator is simply a transceiver that passes all network data between any two branches in the LAN. Note that the concentrator passes all network data between the two branches, regardless of whether or not one node is sending data to another node on the same branch.

To implement the star topology, each network device is connected to a concentrator. The concentrator functions as a central hub and simply passes all network data between each network device in the star segment. Typically, the concentrator supports 8 to 12 network devices and may be linked to other concentrators to form larger networks.

## Node

Each network device or node is assigned an address number and requires a transceiver to interface between the network device and the network. For thick-net and thin-net cabling a transceiver and a serial drop cable connects to the main trunk. The serial drop cable is sometimes referred to as an AUI (attachment unit interface) transceiver cable. For twisted pair cabling, the transceiver is connected directly to the network device.

## Segment and Branch

Some Ethernet systems are comprised of smaller, stand-alone Ethernet systems (called branches or segments) that are connected by bridges, concentrators, or repeaters. Many nodes on the Ethernet network may be serviced by one segment or branch. Each segment may support many patient monitors, central stations, and auxiliary devices.

For example, one segment may connect all the patient monitors and central stations in the ICU (Intensive Care Unit) and another may connect the monitoring system in the CCU (Critical Care Unit). Each segment could be a fully-functioning stand-alone system if they were not connected to each other. However, with a bridge or repeater to connect the ICU (one segment) with the CCU (the other segment), information can pass between any of the nodes (patient monitors and central stations) on either branch similar to a patient transfer from one unit to another.

A section is a single length of twisted pair cable with a RJ-45 connector on each end. A section goes from one twisted pair transceiver to the concentrator. A segment is comprised of all the sections of twisted pair cable connected in a star formation to one concentrator.

## Repeater

A repeater is used to extend the length of cabling when the distance required exceeds the length of the cable specifications. It is simply a transceiver that passes all network data between any two segments. Note that the repeater passes all network data between the two segments, regardless of whether or not the one node is sending data to another node on the same segment.

## Bridge

A bridge is more selective than a repeater with the data that it passes between segments. It also acts as a transceiver between two segments, but it only passes signals if a node on one of the segments is attempting to communicate with a node on the other segment. Since the majority of communication on the network occurs within a single segment, the bridge does not pass all of the data from one segment to the other. This lowers the amount of data traffic passing between segments, and makes the network more efficient than a system that is connected with repeaters.

## Twisted Pair Cabling (10BaseT)

Twisted pair is an IEEE 802.3 local area network that uses flat and small diameter cable containing four pairs of twisted wires to connect devices. Twisted pair operates at the same speed as thin-net and thick-net (10 megabits/second), but the cable distances extended up to 100 meters (328 feet).

A twisted pair transceiver passes data back and forth between the network device and the LAN. It is attached directly to the network device at the at the 15-pin D-type connector. The twisted pair cable is connected from the RJ-45 connector at the transceiver and the RJ-45 connector at the concentrator.

**NOTE:** Some devices (like Octacomm/Solar 8000M patient monitor) have 10BaseT standard meaning that the RJ-45 connector is part of the product and the twisted pair transceiver is not required.

## Symbol PC Card (Wireless LAN)

The Symbol PC card, installed in the monitor, uses a 2.4 GHz frequency band and a Frequency Hopping spread spectrum (FHSS). The Frequency Hopping spread spectrum meets IEEE 802.11 standards.

Two diversity antennas, installed in the handle of the monitor, radiates the RF energy through the air to a Symbol Access Point. The Symbol Access Point also uses a 2.4 GHz frequency band and the Frequency Hopping spread spectrum.

**NOTE:** Refer to the Wireless LAN (Symbol Access Point) Installation and Service Manual for detailed information on the Symbol Access point.

**NOTE:** The following is required for the monitor to roam from access point to access point while maintaining Wireless LAN communication with the Unity Network.

- Installation of the RF LAN (Wireless LAN) option.
- Configuration and verification of the monitor's RF LAN operation.
- Activation of the RF LAN by disconnecting the monitor's Ethernet cable.

# 4 MAINTENANCE

MAINTENANCE:

---

*For your notes*

# Maintenance Schedule

## Manufacturer Recommendations

To ensure the monitor is always functional when required, qualified service personnel should perform the following regular maintenance.

- **Visual Inspection:** Perform a visual inspection upon receipt of the equipment, every 12 months thereafter, and prior to servicing the unit.
- **Cleaning:** Clean the unit upon receipt of the equipment, every 12 months thereafter, and each time the unit is serviced.
- **Conditioning the Batteries:** Condition the batteries once every two months or as needed.
- **Calibrating the NBP, BP, ECG, and End-tidal CO2 Software:** Calibrate the software upon receipt of the equipment, every 12 months thereafter, and each time the unit is opened for service.
- **Electrical Safety Tests:** Perform safety tests upon receipt of the equipment, every 12 months thereafter, and each time the unit is serviced.
- **Checkout Procedure:** Perform the checkout upon receipt of the equipment, every 12 months thereafter, and each time the unit is serviced.
- **Clearing the Stored Patient Data Memory:** Admit and discharge a test patient every 12 months to clear the monitor's stored patient data memory.

## Manufacturer Responsibility

---

---

### CAUTION

Failure on the part of all responsible individuals, hospitals or institutions, employing the use of this device, to implement the recommended maintenance schedule may cause equipment failure. The manufacturer does not, in any manner, assume the responsibility for performing the recommended maintenance schedule, unless an Equipment Maintenance Agreement exists. The sole responsibility rests with the individuals, hospitals, or institutions utilizing the device.

---

---

## Visual Inspection

The monitor and its components should be carefully inspected prior to installation, once every 12 months thereafter and each time the equipment is serviced.

- Carefully inspect the equipment for physical damage to the case, the display screen, and the keypad. Do not use the monitor if damage is determined. Refer damaged equipment to qualified service personnel.
- Inspect all external connections for loose connectors or frayed cables. Have any damaged connectors or cables replaced by qualified service personnel.
- Inspect the display face for marks, scratches, or other damage. Physical damage to a CRT display face may pose an implosion hazard. Have the CRT replaced by qualified service personnel if necessary.
- Safety labels and inscription on the device are clearly legible.



# Cleaning

## Cleaning Precautions

Use one of the following approved solutions:

- Cidex solution, or
- Sodium hypochlorite bleach (diluted), or
- Mild soap (diluted)
- Lint-free cloth
- Dust Remover (compressed air)

To avoid damage to the equipment surfaces, *never* use the following cleaning agents:

- organic solvents,
- ammonia based solutions,
- acetone solution,
- alcohol based cleaning agents,
- Betadine solution,
- a wax containing a cleaning substance, or
- abrasive cleaning agents.

## Cleaning the Display

To clean the display, follow the recommendations of the display's manufacturer. In general you will need to use a soft, clean, lint-free cloth dampened with a glass cleaner.

---

---

### CAUTION

To avoid getting liquid into connector openings, do not spray glass cleaning or general cleaning solutions directly onto the product's surface.

---

---

## Exterior Cleaning

Clean the exterior surfaces with a clean, lint-free cloth and one of the cleaning solutions listed in the table above.

- Wring the excess solution from the cloth. Do not drip any liquid into open vents, switches, plugs, or connectors.
- Dry the surfaces with a clean cloth or paper towel.

## Cleaning the Print Head

Heavy usage causes debris to build up on the print head. This build can cause the printed images to appear distorted. It is recommended that this procedure be performed when necessary, depending on usage.

### Materials Required

A nonabrasive material/cloth and isopropyl alcohol are all that are necessary to perform this procedure.

This procedure should be performed in the order listed.

### Procedure

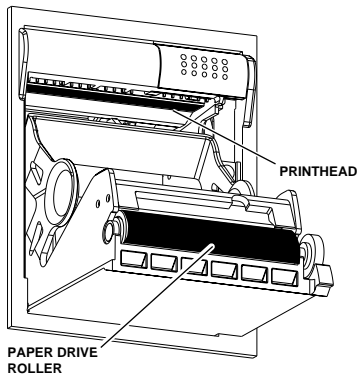

1. Disconnect the power cord from the mains source.
2. Open the writer door to expose the print head.
3. Remove paper roll.
4. Locate print head shown in figure at left. A flashlight may help illuminate the print head for closer examination.
5. Wipe print head with alcohol and a nonabrasive material/cotton swab in an side to side motion. Continue wiping until the cloth/swab wipes clean.
6. Wipe paper drive roller clean of any bits of paper and debris with alcohol and a nonabrasive material.

# Battery Maintenance

## Charging

The battery is charged whenever the monitor is connected to AC power, regardless whether the monitor is turned on or turned off.

## Conditioning the Batteries

A battery conditioning cycle occurs when the following has been completed.

1. The battery is fully charged without interruption.
2. The battery is discharged until the monitor shuts down.
3. The battery is charged until the battery status light turns green in color.

## Frequency Guidelines

To maintain useful life, use the following guidelines to condition a battery:

- Once every two months,
- When the run time of the battery becomes noticeably shorter,
- When the predicted run times become noticeably inaccurate, or
- When the associated battery is requesting a conditioning cycle (i.e., the CHECK BATT STATUS error message is displayed in the ECG waveform area and CONDITION is displayed for BATTERY QUALITY in the Battery Status information window).

## Recommendations

Conditioning a battery is best done on an external charger (see instructions included with the charger). However, a conditioning cycle can also be run on the monitor.

## Procedure

To condition a battery on the monitor, follow this procedure:

1. Disconnect the monitor from the patient and remove it from service.
2. Insert the battery in need of conditioning in one of the battery slots in the monitor, and leave the other slot **EMPTY**.
3. Apply AC power to the monitor and allow the battery to charge uninterrupted until the Charging Status indicator on the front panel turns green.
4. Remove AC power and allow the monitor to run from the battery until it shuts off.
5. Apply AC power again to the monitor and allow the battery to charge uninterrupted until the Charging Status indicator on the front panel turns green.
6. This battery is now conditioned and the monitor can be returned to service.

## Replacing the Batteries

1. Open the battery door. The battery door is on the left side of the monitor, along the bottom.
2. In the middle is a retainer. Turn this *away* from the battery you are replacing.
3. Remove the faulty batteries.

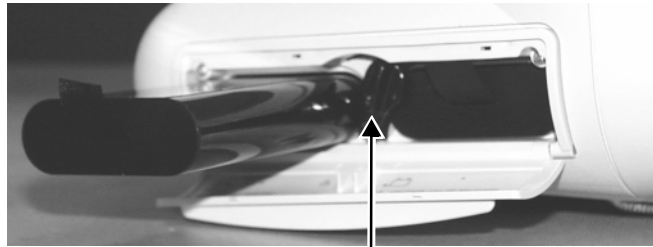

Retainer

4. Replace with a new battery. The monitor uses two exchangeable lithium-ion batteries. Install the battery with the connection pins facing down and inserted first.



5. Close the battery cover. The retainer needs to be straight up for the door to close.
6. Verify that the monitor operates correctly:
  - Confirm that the Battery IDs with a battery icon displays in the lower right corner of the monitor.
  - Verify that the Battery LEDs illuminate either green or amber.

## Disposal

When the battery no longer holds a charge, it should be replaced. The batteries are recycleable. Remove the old battery from the monitor and follow your local recycling guidelines.

---

---

### WARNING

Explosion Hazard. DO NOT incinerate the battery or store at high temperatures.

---

---

# Electrical Safety Tests

## General

Electrical safety tests provide a method of determining if potential electrical health hazards to the patient or operator of the device exist.

These instructions are intended for every component in the system. If the Tram-rac housing does not have its own power supply, it should remain connected to the monitor throughout the safety tests.

Record the date and results on the “Maintenance/Repair Log” included at the end of this chapter.

## Recommendations

GE Medical Systems *Information Technologies* recommends that you perform all safety tests presented in this chapter:

- upon receipt of the device (monitor and its associated equipment),
- every twelve months thereafter, and
- each time the main enclosure is disassembled or a circuit board is removed, tested, repaired, or replaced.

---

---

### CAUTION

Failure to implement a satisfactory maintenance schedule may cause undue equipment failure and possible health hazards. Unless you have an Equipment Maintenance Contract, GE Medical Systems *Information Technologies* does not in any manner assume the responsibility for performing the recommended maintenance procedures. The sole responsibility rests with the individual or institution using the equipment. GE Medical Systems *Information Technologies* service personnel may, at their discretion, follow the procedures provided in this manual as a guide during visits to the equipment site.

---

---

## Test Conditions

Electrical safety tests may be performed under normal ambient conditions of temperature, humidity, and pressure.

## Test Equipment

The manufacturer recommended test equipment required to perform electrical safety tests is listed below. Equivalent equipment may be substituted as necessary.

<b>Required Tools/Special Equipment</b>	
<b>Item</b>	<b>Part Number</b>
Leakage Current Tester 120 V (or equivalent)	DALE 600
240 V (or equivalent)	DALE 600E
Multimeter	–

**Wall Receptacle Test** Before starting the tests, the wall receptacle from which the monitoring device will get electrical power must be checked. This test checks the condition of the wall receptacle to ensure correct results from leakage tests.

For international wall receptacles, refer to the internal standards agencies of that particular country. Use a digital multimeter to ensure the wall receptacle is wired properly.

If other than normal polarity and ground is indicated, corrective action must be taken before proceeding. The results of the following tests will be meaningless unless a properly wired wall receptacle is used.

## Ground (Earth) Integrity

Listed below are two methods for checking the ground (earth) integrity, “Ground Continuity Test” and “Impedance of Protective Earth Connection.” These tests determine whether the device's exposed metal and power inlet's earth (ground) connection has a power ground fault condition.

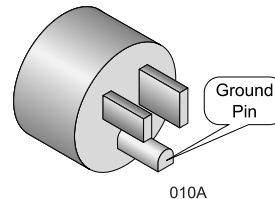

Perform the test method below that is required by your Country/Local governing safety organization.

## Ground Continuity Test

Completion of this test is checked by the following steps:

1. Disconnect the DUT (device under test) from the wall receptacle.
2. Connect the negative(-) lead of the ohm meter to the protective earth terminal (ground pin in power in-let connector) or the protective earth pin in the MAINS PLUG (ground pin in power cord). Refer to the US 120Vac power cord figure on the left.
3. Set the Ohm meter to the milliohm ( $m\Omega$ ) range.
4. Connect the positive (+) lead of the Ohm meter to all exposed metal surfaces on the DUT. If the metal surfaces are anodized or painted scrape off a small area in a inconspicuous area for the probe to make contact with the metal.
5. Resistance should read to pass:
  - 0.1 ohm or less without power cord
  - 0.2 ohms or less with power cord

## Impedance of Protective Earth Connection

This test unlike a ground continuity test will also stress the ground system by using special ground bond testers i.e. Kikusui (model 872 or TOS 6100) or Associated Research model HYAMP® Jr. Model 3030D.

This test normally is only required as a manufacturing production test to receive safety agency compliance (i.e. IEC601-1).

Some country agency's do require this test after field equipment repairs (i.e. Germany's DIN VDE 0751 standards).

Consult your country/local safety agency if in question.

Compliance is checked by the following steps:

1. A current not less than 10A and not exceeding 25A from a current source with a frequency of 50 or 60 Hz with a no-load voltage not exceeding 6 V is passed for at least 5 s through the protective earth terminal or the protective earth pin in the mains plug and each accessible metal part which could become live in case of failure in basic insulation.
2. The voltage drop between the parts described is measured and the impedance determined from the current and voltage drop. It shall not exceed the values indicated.

for equipment without a power supply cord the impedance between the protective earth terminal and any accessible metal part which is protectively earthed shall not exceed 0.1 ohms

For equipment with a power supply cord the impedance between the protective earth pin in the mains plug and any accessible metal part which is protectively earthed shall not exceed 0.2 ohms.

When taking this measurement move the unit's power cord around, no fluctuations in resistance should be observed.



## Ground (Earth) Wire Leakage Current Tests

Perform this test to measure current leakage through the ground (earth) wire of the equipment during normal operation.

1. Set the leakage tester switches as follows:
  - Selector knob - 1,
  - GND switch - OPEN,
  - Polarity switch - NORM,
  - Power switch - OFF.
2. Connect the DMM to the METER jacks on the leakage tester. Set the DMM to measure AC millivolts.
3. Connect the power cord of the device under test to the power receptacle on the rear of the leakage tester.

**NOTE:** The device under test is to be tested at its normal operating voltage.

4. Set the leakage tester power switch to ON.
5. Set the power switch of the device under test to ON.
6. Read the current leakage indicated on DMM. If the reading is greater than the appropriate specification below, the device under test fails and should be repaired and tested again.
  - 300 microamperes (0.3 volts on the DMM), and the device under test is powered from 100-120 V/50-60 Hz
  - 300  $\mu$ A (0.3 volts on the DMM), and the device under test is powered from a centered-tapped 200-240 V/50-60 Hz, single phase circuit
  - 500  $\mu$ A (0.5 volts on the DMM), and the device under test is powered from a non-center-tapped, 200-240 V/50-60 Hz, single-phase circuit

**NOTE:** Center-tapped and non-center-tapped circuits produce different leakage currents and the UL and IEC limits are different.

7. Set the polarity switch on the leakage tester to RVS (reverse).
8. Read the current leakage indicated on DMM. If the reading is greater than the appropriate specification below, the device under test fails and should be repaired and tested again.
  - 300 microamperes (0.3 volts on the DMM), and the device under test is powered from 100-120 V/50-60 Hz
  - 300  $\mu$ A (0.3 volts on the DMM), and the device under test is powered from a centered-tapped 200-240 V/50-60 Hz, single phase circuit
  - 500  $\mu$ A (0.5 volts on the DMM), and the device under test is powered from a non-center-tapped, 200-240 V/50-60 Hz, single-phase circuit

**NOTE:** Center-tapped and non-center-tapped circuits produce different leakage currents and the UL and IEC limits are different.

9. Set the leakage tester power switch to OFF.

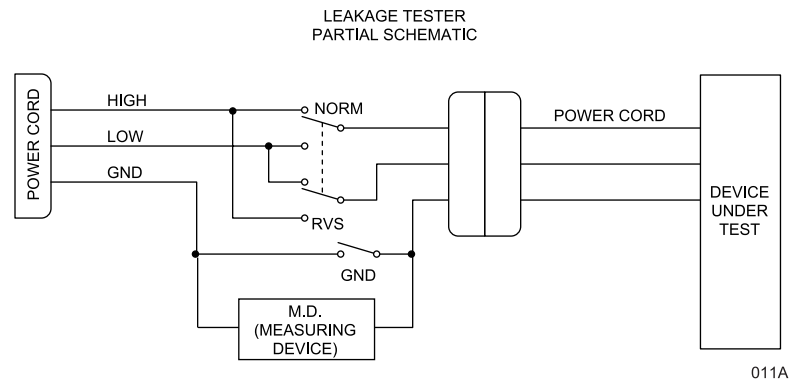

**NOTES:**The MD (measuring device) is the circuitry defined by the appropriate standard for measuring leakage current.

The measuring devices, defined by various standard organizations (IEC, UL, etc.), produce almost identical test measurement results.

## Enclosure Leakage Current Test

Perform this test to measure current leakage through exposed conductive surfaces on the device under test during normal operation.

1. Set the leakage tester switches as follows:
  - Selector knob - 2,
  - GND switch - OPEN, and
  - Polarity switch - NORM.
2. Connect a meter lead between the CHAS connector on the rear of the leakage tester and an unpainted, non-anodized chassis ground on the unit under test.
3. Set the leakage tester power switch to ON.
4. Read the current leakage indicated on DMM. If the reading is greater than the appropriate specification below, the device under test fails and should be repaired and tested again.
  - 300 microamperes (0.3 volts on the DMM), and the device under test is powered from 100-120 V/50-60 Hz
  - 300  $\mu$ A (0.3 volts on the DMM), and the device under test is powered from a centered-tapped 200-240 V/50-60 Hz, single phase circuit
  - 500  $\mu$ A (0.5 volts on the DMM), and the device under test is powered from a non-center-tapped, 200-240 V/50-60 Hz, single-phase circuit

**NOTE:** Center-tapped and non-center-tapped circuits produce different leakage currents and the UL and IEC limits are different.

5. Set the polarity switch to RVS and observe the same meter readings as in the previous step.
6. Set the GND switch on the leakage tester to CLOSED.
7. Read the current leakage indicated on DMM. If the reading is greater than the appropriate specification below, and the device under test is powered from 100-240 V/50-60 Hz, the device under test fails and should be repaired and tested again.
  - 100 microamperes (0.1 volts on the DMM), and the device under test is powered from 100-240 V/50-60 Hz
8. Set the polarity switch to RVS and observe the same meter readings as in the previous step.
9. Set the leakage tester power switch to OFF and remove the meter lead connected in step 2.

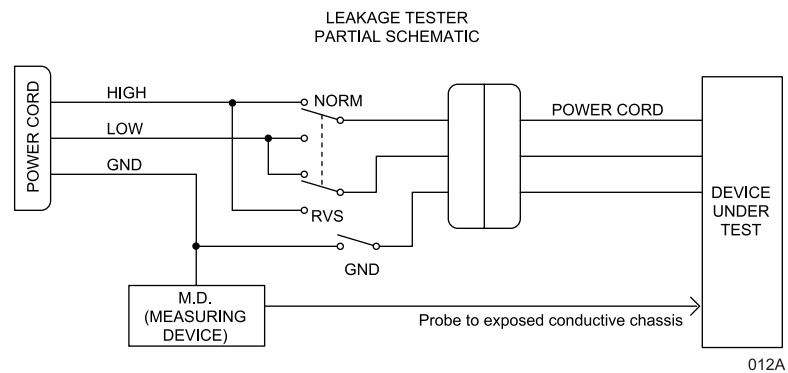

## Patient (Source) Leakage Current Test

### Test Equipment

Equipment required to perform these tests is listed below. Equivalent equipment may be substituted as necessary.

Name	Manufacturer	Part Number
ECG Test Body	GE Medical Systems <i>Information Technologies</i>	MT-3387
Temp/CO Test Body	GE Medical Systems <i>Information Technologies</i>	MT-3644

This procedure only applies to Class I (grounded/earthed) equipment, and measures the leakage current from the ECG and TEMP/CO connectors of the device to ground.

1. Set leakage tester switches as follows:
  - Selector knob – 3,
  - GND switch – GND OPEN,
  - Polarity switch – NORM,
  - Power switch – OFF.
2. Connect an ECG test body to the ECG connector of the DUT.
3. Connect a short length of cable between the ECG test body installed in the last step and the jacks on the top of the leakage tester.
4. Set the leakage tester power switch to ON.
5. Set the rear panel power switch of the device to ON.
6. Read the leakage current indicated on the DMM.

If the reading is greater than 50  $\mu\text{A}$  (0.05 volts on the DMM), the device under test fails this test and should be repaired and tested again.

**NOTE:** The AAMI and IEC single fault condition (ground open) is 50  $\mu\text{A}$ , whereas the normal condition (ground closed) is less.

7. Change the leakage tester polarity switch to the RVS position.
8. Read the leakage current indicated on the DMM.

If the reading is greater than 50  $\mu\text{A}$  (0.05 volts on the DMM), the device under test fails this test and should be repaired and tested again.

**NOTE:** The AAMI and IEC single fault condition (ground open) is 50  $\mu\text{A}$ , whereas the normal condition (ground closed) is less.

9. Change the GND switch to the CLOSED position.

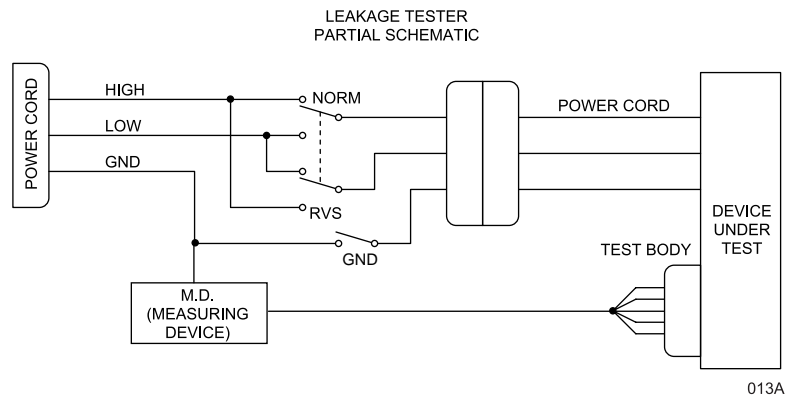

10. Read the leakage current indicated on the DMM.
11. If the reading is greater than 10  $\mu\text{A}$  (0.01 volts on the DMM), the device under test fails this test and should be repaired and tested again.
12. Change the leakage current switch to the RVS position.
13. Read the leakage current indicated on the DMM.
14. If the reading is greater than 10  $\mu\text{A}$  (0.01 volts on the DMM), the device under test fails this test and should be repaired and tested again.
15. Set the power switch of the leakage tester to OFF.
16. Repeat all previous steps for the TEMP/CO connector using the appropriate test body.

## Patient (Sink) Leakage Current Test (Mains Voltage on the Applied Part)

This procedure only applies to Class I (grounded/earthed) equipment, and measures the leakage current from a mains voltage source into the ECG and TEMP/CO connectors.

1. Set the leakage tester switches as follows:
  - Selector knob – 5,
  - GND switch – CLOSED,
  - Polarity switch – NORM.
2. Disconnect the test cable from the leakage tester PATIENT JACKS (TOP) and reconnect it to the PATN JACK connector on the front panel of the leakage tester.

---

---

### WARNING

The following step will cause high voltage (120 VAC to 240 VAC) to appear at the PATN JACK on the leakage tester. **Do not** touch the PATN JACK posts or ECG lead clips during this test as an electrical shock will occur.

---

---

3. Set power switch on the leakage tester to ON.
4. Read leakage current indicated on DMM.

If the reading is greater than the appropriate specification below, the device under test fails this test and should be repaired and tested again.

- 10  $\mu$ A, (0.01 volts on the DMM) at 120 VAC without the patient cable.
- 20  $\mu$ A (0.02 volts on the DMM) at 240 VAC without the patient cable.

**NOTE:** The 10 and 20  $\mu$ A limit are based on internal design standards.

- 50  $\mu$ A (0.05 volts on the DMM) at 120-240 VAC with the patient cable.

**NOTE:** The 50  $\mu$ A limit is common to all standards. AAMI ES-1 standard requires using the patient cable.

5. Change the leakage tester polarity switch to the RVS position.

6. Read the leakage current indicated on the DMM.

If the reading is greater than the appropriate specification below, the device under test fails this test and should be repaired and tested again.

- 10  $\mu\text{A}$  (0.01 volts on the DMM) at 120 VAC without the patient cable.
- 20  $\mu\text{A}$  (0.02 volts on the DMM) at 240 VAC without the patient cable.

**NOTE:** The 10 and 20  $\mu\text{A}$  limits are based on internal design standards.

- 50  $\mu\text{A}$  (0.05 volts on the DMM) at 120-240 VAC with the patient cable.

**NOTE:** The 50  $\mu\text{A}$  limit is common to all standards. AAMI ES-1 standard requires using the patient cable.

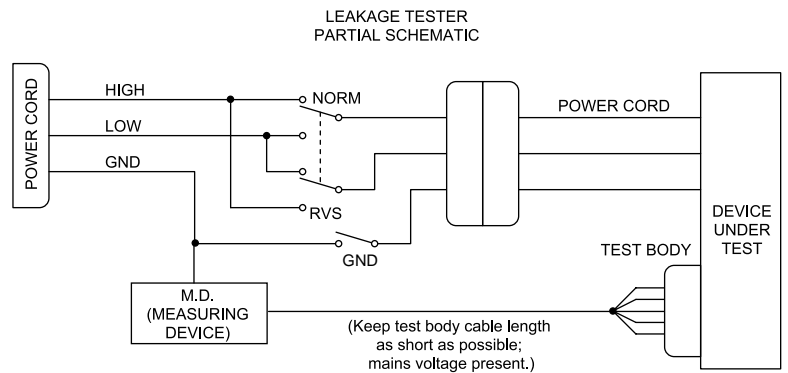

014A

7. Set the power switch on the leakage tester to OFF.
8. Repeat all previous steps for the TEMP/CO connector using the appropriate test body.

## Test Completion

Disconnect all test equipment from the device. Disconnect the device power cord plug from the leakage tester power receptacle. Disconnect the leakage tester from the wall receptacle.



## Hi-Pot (Dielectric Withstand) Test

The high potential (Hi-Pot) tests provide a method of checking patient isolation circuits and protect patients connected to the device under test from potential electrical health hazards. These tests are recommended for direct patient-connected medical devices to check the integrity of the patient isolation circuitry after any isolated component in the device has been repaired.

### Recommendations

The manufacturer recommends that hi-pot tests be performed whenever a circuit board in the patient-isolated DAS assembly of the device under test is removed, repaired, or replaced.

---



---

#### WARNING

Failure to perform hi-pot tests may cause undue equipment failure and possible health hazards. The manufacturer does not in any manner, unless an Equipment Maintenance Agreement exists, assume the responsibility for performing these recommended hi-pot tests. The sole responsibility rests with the individuals, hospitals or institutions utilizing this equipment. Manufacturer service representatives may, at their discretion, use this procedure as a helpful guide during visits to the equipment site.

---



---

### Test Conditions

These tests may be performed under normal ambient conditions of temperature, humidity, and pressure.

### Test Equipment

Equipment required to perform these tests is listed below. Equivalent equipment may be substituted as necessary.

Name	Manufacturer	Part Number
AC/DC Hi-Pot Generator	Hipotronics	AD125
ECG Test Body	GE Medical Systems <i>Information Technologies</i>	MT-3387
Aux/Ethernet Test Body	GE Medical Systems <i>Information Technologies</i>	MT-5265
Temp/CO Test Body	GE Medical Systems <i>Information Technologies</i>	MT-3644
Power Cord Hi-Pot Body	GE Medical Systems <i>Information Technologies</i>	MT-4542

### Preparation

Follow these steps in the same order in which they are listed.

- Set up the AC/DC Hi-Pot Generator in the following manner:
  - Power switch – ON,
  - VOLTAGE RANGE selector – MEDIUM (10 kVA),
  - RAISE VOLTAGE selector – 0 volts,
  - OUTPUT & CURRENT selector – 2 mA range, and
  - Allow the tester to warm up for 15 minutes before continuing with this test.
- Connect the ground pin on the power cord connector of the device under test to the ground of the AC/DC Hi-Pot Generator.

## DAS Assembly AC Hi-Pot Test

Perform the AC hi-pot tests for both the ECG and Temp/CO side panel connectors of the device under test. This only needs to be performed when the DAS assembly is opened.

---

---

### CAUTION

Never attempt to perform this test on any of the other front panel connectors of the device under test. Damage to the device under test may occur if this test is performed on any of the other front panel connectors.

---

---

1. Attach the black lead from the Hi-Pot generator to the ground prong of the power cord.
2. Install an ECG dead body plug (pn MT-3387) and the Temp/CO dead body plug (pn MT-3644) on the side panel. Connect the red high voltage lead from the Hi-Pot generator to the exposed lead of the ECG dead body plug. Jumper the exposed lead of the Temp/CO dead body plug to the black high voltage lead. Set the current limit to 1 mA on the Hi-Pot generator.

**NOTE:** During this test, watch the analog meter to ensure the current level never exceeds 1 mA. If it does, the unit has failed the test and must be repaired then tested again.

---

---

### WARNING

The following steps cause high voltage (4000 V AC) to appear at the test body.

---

---

3. Set the voltage switch to AC and the scale to 10KV. Turn ON the Hi-Pot generator and bring up the voltage to 4000 VAC RMS for a period of 60 seconds. The breakdown warning lamp or buzzer must not activate. Turn OFF the Hi-Pot generator.
4. Connect the red high voltage lead from the Hi-Pot generator to the exposed lead of the Temp/CO dead body plug. Jumper the exposed lead of the ECG dead body plug to the black high voltage lead. Repeat step three.
5. If the device under test fails, repairs must be made and the unit must be tested again.
6. This completes the AC hi-pot test for the DAS assembly.

## Processor/Power Management PCB Hi-Pot Test

This test is only required when you repair the isolated Ethernet or Aux circuitry. This test pertains to the Ethernet and Aux ports on the rear of the unit.

---

---

### CAUTION

Never attempt to perform this test on any of the other rear panel connectors of the monitor. Damage to the monitor may occur if this test is performed on any of the other rear panel connectors.

---

---

1. Attach the black lead from the Hi-Pot generator to the ground prong of the power cord.
2. Install the Dash AUX/Ethernet Hi-Pot test body (pn MT-5265) to the AUX and Ethernet connectors on the rear of the monitor. Connect the high voltage lead from the Hi-Pot generator to the exposed lead of the Ethernet port test body. Jumper the exposed lead of the AUX connector test body to the black high voltage lead.

**NOTE:** During this test, watch the analog meter to ensure the current level never exceeds 1 mA. If it does, the unit has failed the test and must be repaired and tested again.

---

---

### WARNING

The following step can cause high voltage (1500 VAC) to appear at the test body.

---

---

3. Set the voltage switch to AC and the scale to 10KV. Turn ON the Hi-Pot generator and bring up the voltage to 1500 VAC RMS for a period of 60 seconds. The breakdown warning lamp or buzzer must not activate. Turn OFF the Hi-Pot generator.
4. Connect the high voltage lead from the Hi-Pot generator to the exposed lead of the AUX test body. Jumper the exposed lead of the Ethernet lead dead body to the black high voltage lead. Repeat step three.
5. If the unit under test fails, repairs must be made and the unit must be tested again.
6. This completes the processor/power management PCB Hi-Pot test.

**AC Mains Hi-Pot Test** Perform the following steps to hi-pot the AC mains dielectric relative to ground. This applies only to actual board repair!

1. Set up the AC/DC Hi-Pot Generator in the following manner:
  - VOLTAGE RANGE selector - MEDIUM (10 kVA),
  - RAISE VOLTAGE selector - 0 volts,
  - OUTPUT & CURRENT selector - 5 mA range,
  - Power switch - ON, and
  - allow the tester to warm up for 15 minutes before continuing with this test.
2. Connect the ground pin on the power cord connector of the monitor to the BLACK ground of the AC/DC Hi-Pot Generator.
3. Connect the LINE and NEUTRAL to the RED lead of the hi-pot test.

---

---

**WARNING**

To avoid electric shock by accidentally shorting line voltage to ground, make and use a receptacle adapter that connects the LINE voltage and NEUTRAL together separate from any ground potential.

---

---

4. Slowly turn the RAISE VOLTAGE selector to 1500 volts.
5. Wait for 60 seconds. If the breakdown warning lamp illuminates or the buzzer activates before the time expires, then the unit has failed the test and should be repaired then tested again.
6. Slowly turn the RAISE VOLTAGE selector to 0 volts.
7. Set the HIGH VOLTAGE switch to OFF. The high voltage indicator should turn off.
8. If the unit under test fails, repairs must be made and the unit must be tested again.

This completes the AC mains hi-pot test.

# Checkout Procedures

These checkout procedures provide service personnel with a method to verify operational and functional performance of the monitor. Failure to attain any of the listed results indicates a potential malfunction of the monitor.

Perform the checkout procedures when you receive the monitor, every twelve months thereafter, and each time you service the unit.

The checkout procedures are based on the assumption that the tested monitor has known good cables and test equipment. It also requires that the user be familiar with the operation of all test equipment required for the checkout procedures. For more information concerning the operation of these components, refer to the respective operator manual(s).

## Manufacturer Recommended Test Equipment

The following table lists GE Medical Systems *Information Technologies*' recommended test equipment, adaptors, and cables you need to successfully complete the checkout procedures. The checkout procedures are written for the test equipment in the following table. If you use test equipment other than those GE Medical Systems *Information Technologies* recommends, you may need to slightly modify some test steps.

Description	Part Number	Qty
Multifunction Micro-simulator	MARQII	1
Cardiac Output Simulator II	900028-001	1
Patient cable, 5-leadwire, AHA	403061-001	1
Leadwire Set, 5-Leadwire, AHA	403066-005	1
BP Adapter	700095-001	2
Temperature Adaptor	402015-004	1
TEMP-to-Simulator Cable	6770031	1
CO Adaptor	900028-001	1
SpO <sub>2</sub> Simulator	408610-001	1
SpO <sub>2</sub> Simulator Cable, Nellcor	700232-004	1

## Monitor Power-up Tests

1. Remove the batteries and unplug the monitor from AC power to turn it off.
2. Restore the batteries to the monitor and plug the monitor into AC power to turn it on.
3. Verify all four front panel indicators illuminate on power up.
4. Verify the AC indicator stays illuminated.

**NOTE:** If the AC LED stays on, but the screen is blank, the monitor is likely in “standby mode” (battery charging). Press the POWER button to enter the normal mode.

- If the AC indicator is on, continue with the tests.
  - If either of the CHARGING STATUS indicators is yellow, wait for the battery(ies) to fully charge and the indicators to illuminate green. The batteries may take up to four hours to charge.
  - If the battery “fuel gauge” displays the word “ERROR,” the battery may be asleep. See “Error Message” on page 5-11.
5. Verify the optional alarm indicator lights both red and amber on power up.
  6. Verify an audio “Beep” sounds at the end of Boot up.
  7. Test all of the front panel keys and the Trim Knob control. Verify that an audio “Beep” sounds after each key press.
  8. Check battery power for both batteries.
    - Pull the AC plug and open the battery door. Verify one LED in the battery compartment is on (batteries must have more than 10% charge).
    - Pull that battery out and verify the other LED lights, thus indicating the unit is powered by the other battery.
    - Reinstall battery and plug in monitor.

## ECG Tests

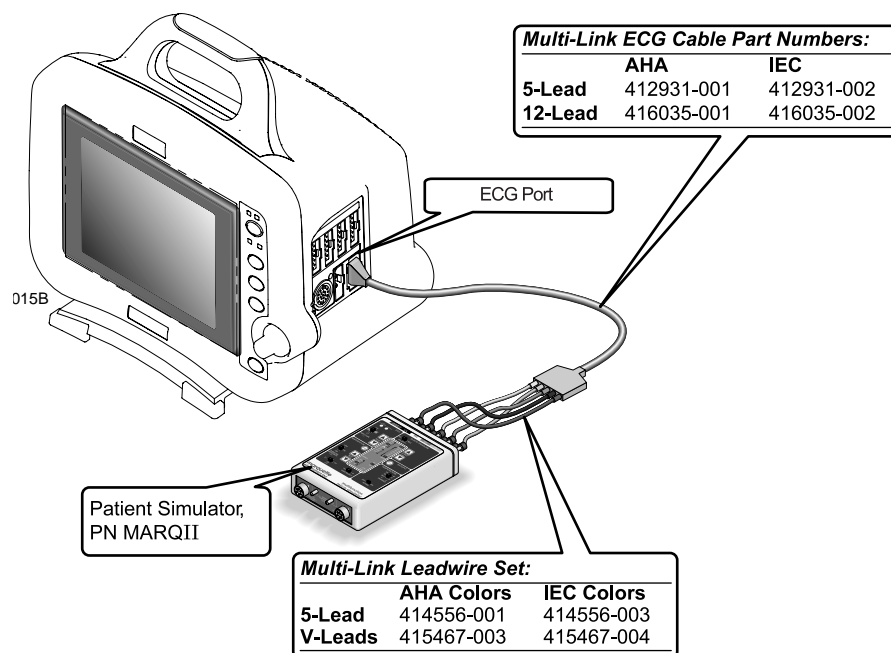

### 5 Lead ECG Test

Perform this test if the monitor acquires 5 lead ECG data.

1. Set up the patient simulator as follows.
  - Heart rate – 80 bpm.
  - Heart rate amplitude – 1.0 mV.
  - 5-lead ECG patient cable properly attached.
  - 2x gain for MARQI or MARQII simulator.
2. Attach the ECG patient cable and ECG leadwire set to the ECG/RESP connector on the monitor and the leadwire connectors on the top of the patient simulator.
3. Admit the patient simulator to the monitor.
4. Observe the following:
  - ECG lead II is displayed and is noise-free,
  - Heart rate of 80 ±1 bpm is displayed,
  - With QRS tones enabled, an audible tone sounds with each R-Wave (QRS complex).
5. Verify all six ECG leads are available to view and are noise-free.
6. Select DETECT PACE and set to PACE 2.
7. Select the VP2 pacemaker pulse on the simulator.
8. Observe the following while you view ECG leads I, II, III, aVL, aVF, and V5:
  - a “P” appears above the PVC count indicating pacemaker pulse detection is enabled, and
  - the heart rate still reads 80 ±1 bpm.

9. Disable pacemaker pulse detection on the monitor and return the simulator to these conditions:
  - Heart rate – 80 bpm,
  - Heart rate amplitude – 1.0 mV,
  - 5-lead ECG patient cable properly attached.
10. Select ECG lead II to view in the top trace position on the monitor display.
11. Disconnect the RA leadwire from the patient simulator.
12. Observe that:
  - a RA FAIL message appears on the display, and
  - lead III automatically displays in place of lead II in the top trace position.
13. Reconnect the RA leadwire to the patient simulator.
14. Inject a 1-millivolt calibration signal using the patient simulator and start a manual graph.
15. Observe that the calibration pulse properly displays and graphs.

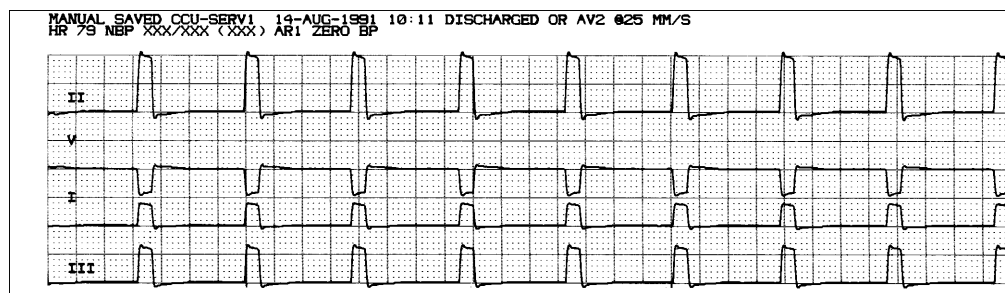

016A

16. This completes the 5 Lead ECG test. Continue to the next steps of these checkout procedures.

## 12SL and ACI-TIPI ECG Test

Perform this test if your monitor uses the 12SL ACI-TIPI ECG option.

1. Set up the patient simulator as follows:
  - Heart rate – 80 bpm.
  - Heart rate amplitude – 1.0 mV.
  - 12SL ECG patient cable (5-leads with V leads) properly attached.
  - 2x gain for MARQI or MARQII simulator.
2. Select *ECG* from the monitor menu. Then, select *12 Lead ECG Analysis*.
3. Verify that the monitor is displaying 10 noise-free leads.
4. Select *12LD ECG Now*. Wait for the monitor to acquire and analyze the data.
5. Select *Transmit-Print*.
6. Verify the 12SL ECG prints at the graph location assigned in the monitor's *Graph Setup* --> *12SL Graph Location*.
  - If there is no graph location is assigned, an error message appears on the bottom of the monitor's display.



7. Verify the ECG is transmitted to the MUSE Cardiovascular Information System. Verify the ECG prints out correctly as defined by the MUSE system.
  - If no MUSE system is connected , an error message appears on the bottom of the monitor's display.
8. Delete this test 12SL ECG from the MUSE system's edit list.

## Respiration Tests

1. With the ECG patient cable still connected to the ECG/RESP connector of the monitor, set up the patient simulator as follows:
  - Respiration (RESP) baseline impedance –  $750\Omega$ ,
  - RESP  $\Delta R$  –  $0.5\Omega$ ,
  - RESP lead select – I & II,
  - RESP rate (respirations per minute) – 30.
2. Set up the monitor as follows:
  - RESP waveform – on,
  - RESP waveform lead select – lead II (RESP waveform derived from ECG lead II).
3. Observe the following:
  - RESP parameter window appears on the monitor with a reading of  $30 \pm 2$  (respirations per minute),
  - RESP waveform appears distortion-free on the monitor.
4. Change the RESP waveform lead select of the monitor to lead I (RESP waveform derived from ECG lead I).
5. Observe the following:
  - RESP parameter window appears on the monitor with a reading of  $30 \pm 2$  (respirations per minute),
  - RESP waveform appears distortion-free on the monitor.
6. Disconnect the ECG patient cable from the ECG/RESP connector of the monitor. Proceed to the next steps in these checkout procedures.

## Temperature Tests

1. Set up the patient simulator for a temperature output of 37°C.
2. Attach the temperature adaptor cable to the TEMP/CO connector of the monitor.
3. Set the switch on the temperature adaptor to the 400 position.
4. Attach the temperature simulator cable from the SERIES 400 TEMPERATURE OUTPUT connector of the patient simulator to the T1 connector of the temperature adaptor.

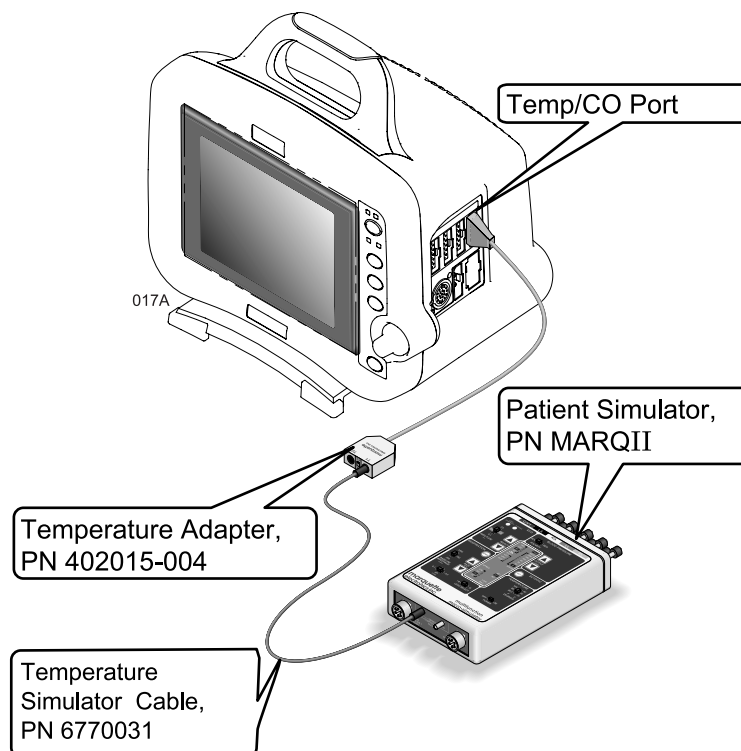

5. Verify a TEMP parameter window appears on the monitor display with a T1 reading of  $37.0^{\circ} \pm 0.4^{\circ} \text{ C}$ .
6. Move the temperature simulator cable from the T1 connector of the temperature adaptor to the T2 connector of the temperature adaptor.
7. Verify a T2 reading of  $37.0^{\circ} \pm 0.4^{\circ} \text{ C}$  in the TEMP parameter window on the monitor display.
8. Remove the temperature adaptor and temperature simulator cable from the monitor and patient simulator.

## Cardiac Output Tests

1. Connect the cardiac output (CO) cable adaptor to the TEMP/CO connector of the monitor.
2. Connect a simulator cable between the CO cable adaptor and the CO simulator.

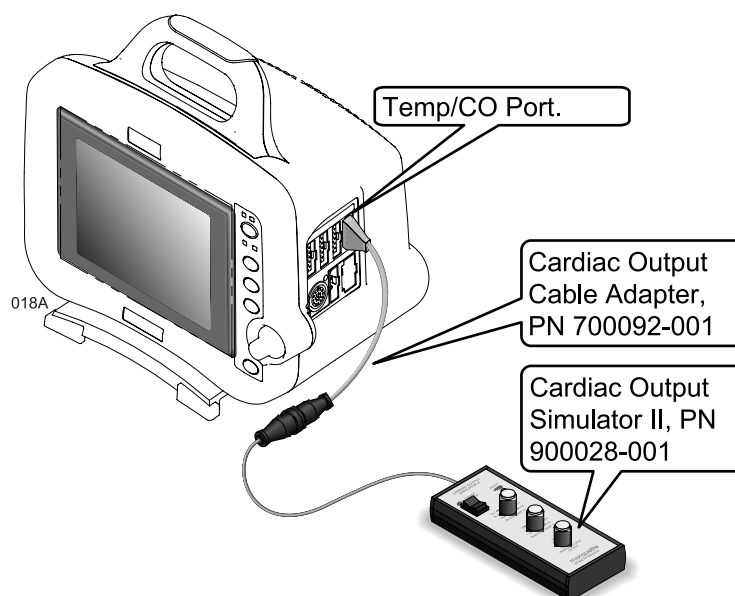

3. Set the CO simulator to output blood temperature (BT) readings, as found in the following table:

Simulator BT Setting	Monitor BT Reading Range
30.3°C	30.1 – 30.5
35.1°C	34.9 – 35.3
36.0°C	35.8 – 36.2
37.0°C	36.8 – 37.2
41.7°C	41.5 – 41.9

4. Verify a CO parameter window appears on the monitor display with correct BT readings as shown in the table above.
5. Set the CO simulator to output injectate temperature (IT) readings, as found in the following table:

<b>Simulator IT Setting</b>	<b>Monitor IT Reading Range</b>
0.0°C	-0.3 – +0.3
8.0°C	7.7 – 8.3
15.0°C	14.7 – 15.3
24.0°C	23.7 – 24.3
29.6°C	29.3 – 29.9

6. Verify correct IT readings appear on the monitor display, as shown in the table above.
7. Disconnect the CO cable adaptor from the TEMP/CO connector of the monitor. This completes the CO tests.

## Invasive Blood Pressure Tests

The invasive blood pressure (BP) tests provide a method of verification for both BP connectors (BP1 and BP2) of a monitor equipped with this optional function. Follow these steps:

1. Set up the patient simulator as follows:
  - Blood pressure (BP) polarity – POS,
  - BP output – 0 mmHg.

### BP1 Connector (AR1) Tests

1. Connect the BP simulator cable from the BLOOD PRESSURE 1 - 120/80 connector of the patient simulator to the BP1 (left-most BP) connector of the monitor.

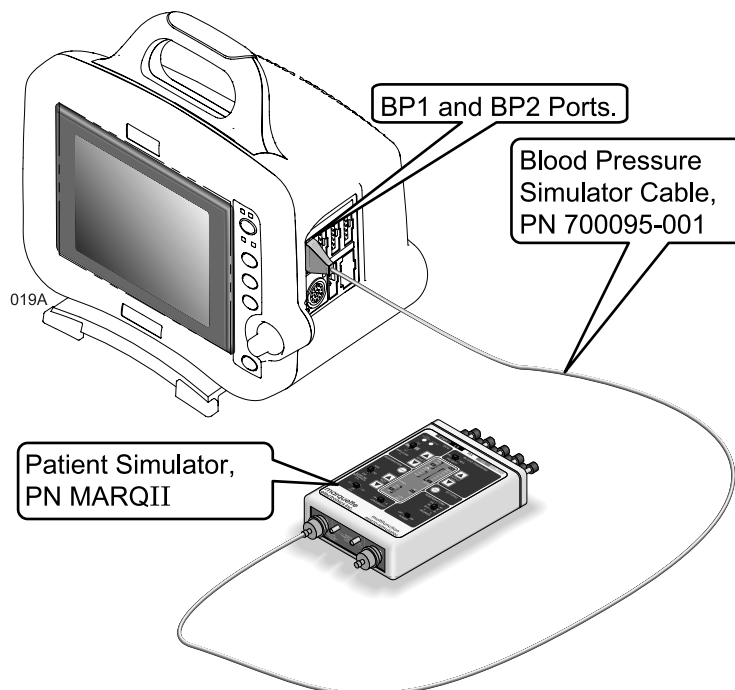

2. Verify the AR1 parameter window, waveform label, corresponding graticules, and waveform appear on the monitor display, along with a BP waveform requiring zero reference.
3. Press the **FUNCTION** key on the front panel of the monitor to zero-reference the AR1 BP waveform.
4. Change the patient simulator BP output to 200 mmHg.
5. Observe a reading of 200/200 (200)  $\pm$  4 mmHg in the AR1 parameter window on the monitor display.
6. Change the patient simulator BP output to WAVE (simulated BP waveform).
7. Set the AR1 BP waveform gain on the monitor to auto.

8. Observe a distortion-free AR1 BP waveform and a reading of approximately 120/80 (93) in the AR1 parameter window on the monitor display.
9. Disconnect the BP simulator cable from the BP1 connector of the monitor. Continue to the next step for the BP2 test.
10. Again, set up the patient simulator as follows:
  - BP polarity – POS,
  - BP output – 0 mmHg.

## BP2 Connector (PA2) Tests

1. Connect the BP simulator cable to the BP2 (right-most BP) connector of the monitor.
2. Verify a PA2 parameter window, waveform label and corresponding graticules appear on the monitor display, along with a PA2 BP waveform requiring zero reference.
3. Press the **FUNCTION** key on the front panel of the monitor to zero reference the PA2 BP waveform.
4. Change the patient simulator BP output to 200 mmHg.
5. Observe a reading of 200/200 (200)  $\pm$  4 mmHg in the PA2 parameter window on the monitor display.
6. Change the patient simulator BP output to WAVE (simulated BP waveform).
7. Set the PA2 BP waveform gain on the monitor to auto.
8. Observe a distortion-free PA2 BP waveform and a reading of approximately 120/80 (93) in the PA2 parameter window on the monitor display.
9. Remove the BP simulator cable from the BP2 connector of the monitor. This completes the BP tests.

## Pulse Oximetry Tests

1. Set the pulse oximetry (SpO<sub>2</sub>) simulator power switch to the off position.
2. Connect the Nellcor-style SpO<sub>2</sub> simulator cable between the SpO<sub>2</sub> connector of the monitor and the SpO<sub>2</sub> simulator.

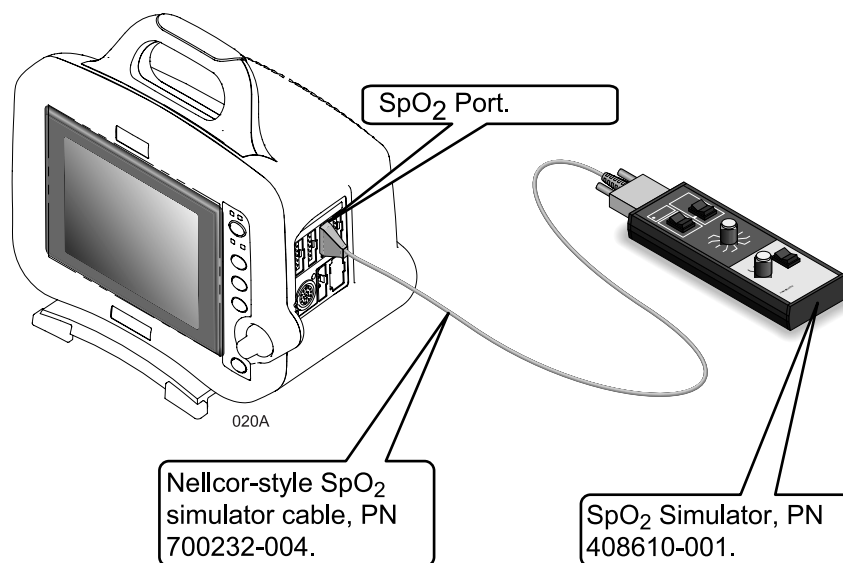

3. Set up the SpO<sub>2</sub> simulator as follows:
  - SPO<sub>2</sub> – 99% (using the white NELLCOR values),
  - PULSE RATE – 100 B/M (beats per minute),
  - MODE – NELLCOR,
  - Power switch – on.
4. Verify a SPO<sub>2</sub> parameter window and waveform label appear on the monitor display.
5. Verify the following appear on the monitor display:
  - Sinusoidal SpO<sub>2</sub> waveform,
  - SPO<sub>2</sub>% parameter reading of 97-102 (%),
  - PPR parameter reading of 97-103 (beats per minute).
6. Verify accuracy of the SPO<sub>2</sub>% values (these are the white NELLCOR values shown on the SpO<sub>2</sub> simulator) on the monitor display using the SpO<sub>2</sub> simulator settings from the following table:

SpO <sub>2</sub> Simulator Setting	Displayed SPO <sub>2</sub> % Value
99%	97 – 102
85.5%	83 – 88
68.4%	66 – 71



7. Verify accuracy of the PPR values on the monitor display using the SpO<sub>2</sub> simulator pulse rates from the following table.

<b>Simulator PULSE RATE</b>	<b>Displayed PPR Value</b>
70 B/M	68 – 72
100 B/M	97 – 103
160 B/M	156 – 164

8. Press the INTERFERENCE TEST button on the SpO<sub>2</sub> simulator for 30 seconds.
9. Verify the displayed SPO<sub>2</sub>% value remains 97–102%, or an interference detection message is displayed and XX is displayed in the SpO<sub>2</sub> parameter window in place of an SPO<sub>2</sub>% value.
10. Set the SpO<sub>2</sub> simulator power switch to the off position.
11. Disconnect the Nellcor-style SpO<sub>2</sub> simulator cable from the monitor SpO<sub>2</sub> connector. This completes the SpO<sub>2</sub> tests.

## Noninvasive Blood Pressure Tests

1. Attach the digital manometer, noninvasive blood pressure (NBP) cuff, tees and tubing, as shown in the illustration below, to the NBP connector of the monitor.

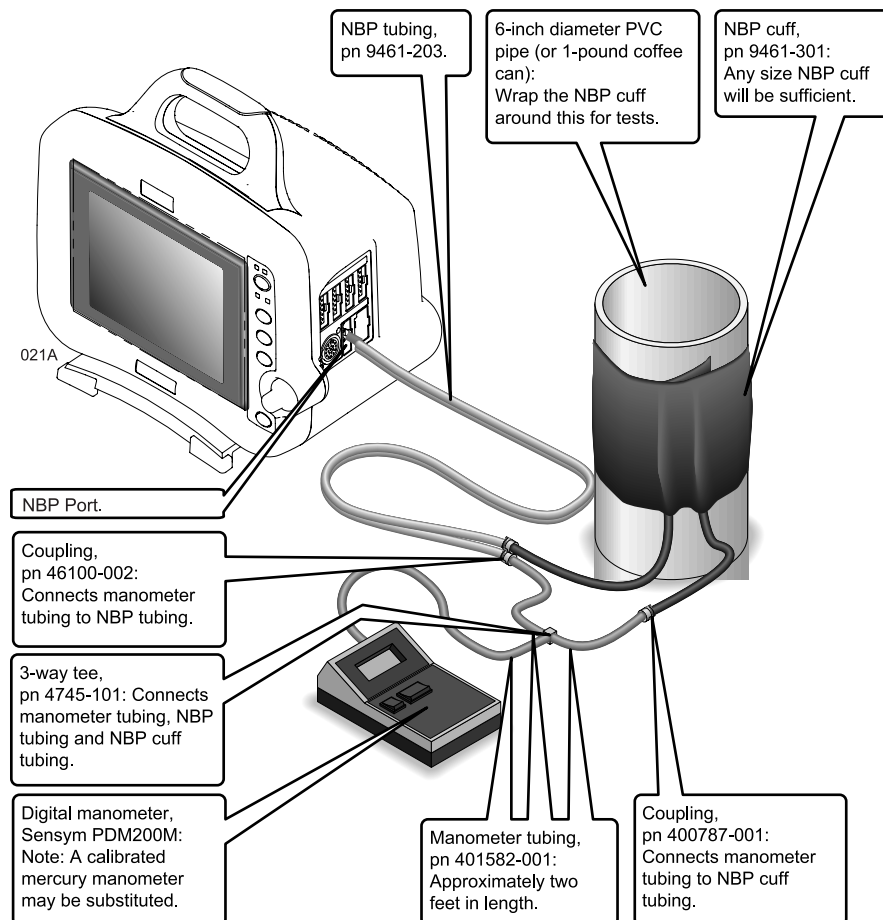

2. Set the digital manometer power switch to the on position.
3. Set the digital manometer range switch to 1000 mmHg.

To perform the noninvasive blood pressure (NBP) tests, version 1A software is assumed to be installed in the monitor.

Using the Trim Knob control, access the *SERVICE MODE* menu starting from the *MAIN* menu.

1. Select *MORE MENUS -> MONITOR SETUP -> SERVICE MODE ->*
2. Enter password using the Trim Knob control to select the day and month from monitor screen with leading zeros. (e.g. July 4 = 0407).

3. Select *CALIBRATE*-> *CALIBRATE NBP*-> *CHECK CAL OFF*-> *START*->.

The text on the menu item changes from *CHECK CAL OFF* to *CHECK CAL IN PROGRESS*.

Verify the readings in the NBP parameter window on the monitor display and readings on the digital manometer are equal ( $\pm 1$  mmHg) for at least one full minute. If the readings are not equal for at least one full minute, the NBP circuit requires calibration.

4. Select *CHECK CAL IN PROGRESS*-> *STOP*->.

The pneumatic control circuit of the monitor vents air pressure in the pneumatic circuit of the monitor to atmosphere and causes the NBP cuff to deflate.

5. Remove the NBP test setup apparatus from the monitor. The NBP tests are complete.

## Analog Output and Defibrillator Synchronization Tests



1. Use the figure at the left as a reference for connecting the oscilloscope to the DEFIB SYNC connector, located on the back panel of the monitor, for performing these tests.
2. Test the ECG, Arterial BP, and Marker Out signals from the DEFIB SYNC connector. They should closely resemble the waveforms in the figures below.

### DEFIB Sync Connector: ECG

**Signal Pin:** — 7  
**Ground Pin:** — 3  
**Probe Type:** — x10  
**Time/Division:** — 0.2S  
**Volts/Division:** — 0.5V

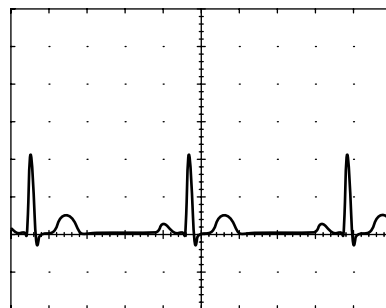

023A

### DEFIB Sync Connector: Arterial BP

**Signal Pin:** — 6  
**Ground Pin:** — 5  
**Probe Type:** — x10  
**Time/Division:** — 0.2S  
**Volts/Division:** — 0.2V

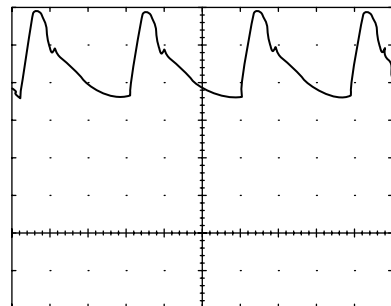

024A

There are two Marker Out traces shown below. The upper Marker Out figure references the frequency aspects of the signal. The lower Marker Out figure references the pulse width aspects of the signal.

**NOTE:** The Marker Out amplitude and the pulse width are configured in the boot menu as described in the configuration chapter. The following two graphs indicate an amplitude of 5V and a pulse width of 10ms.

DEFIB Sync Connector:  
Marker Out (Frequency)

**Signal Pin:** — 1  
**Ground Pin:** — 8  
**Probe Type:** — x10  
**Time/Division:** — 0.2S  
**Volts/Division:** — 1V

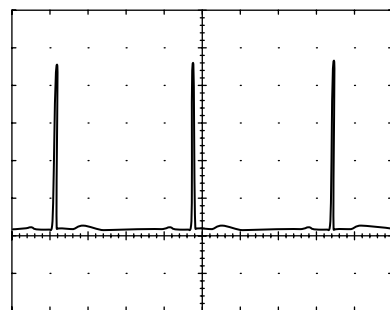

025A

DEFIB Sync Connector:  
Marker Out (Pulse Width)

**Signal Pin:** — 1  
**Ground Pin:** — 8  
**Probe Type:** — x10  
**Time/Division:** — 5mS  
**Volts/Division:** — 1V

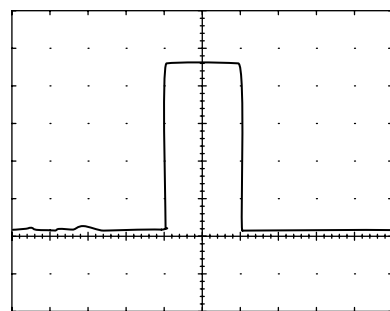

026A

## Verify Markers

3. Attach a jumper wire between pin-1 (Marker Out) and pin-2 (Marker In) of the DEFIB SYNC connector located on the back of the monitor. Verify negative spikes in each of the QRS Complex (ECG waveform) R-Waves on the monitor display, similar to those shown in the illustration below.

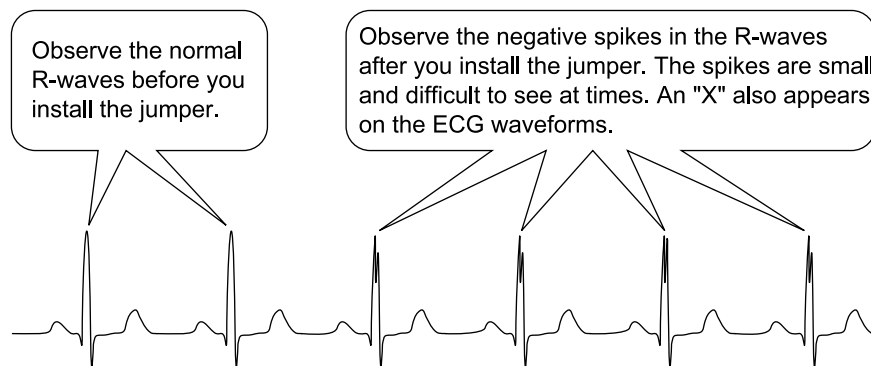

027A

4. Remove the jumper wire installed in the previous step, from the DEFIB SYNC connector. This completes the defibrillator synchronization tests.

## Battery Tests

1. Disconnect the power cord plug from the wall receptacle.
2. Verify the BATTERY front panel indicator illuminates. This indicates operation from the monitor's battery power.
3. Setup the patient simulator as follows:
  - ECG heart rate – 80 bpm,
  - ECG amplitude – 1.0 mV,
  - 5-lead patient cable attached.
4. Observe the following:
  - ECG Lead II is displayed and is noise-free,
  - Heart rate of 80 ±1 bpm is displayed,
  - With *QRS VOLUME* enabled, an audible tone sounds with each R-Wave.
5. Verify all six ECG leads are selectable for display on the monitor.
6. Connect the power cord plug to the wall receptacle.
7. Verify the AC front panel indicator illuminates. This indicates the monitor is operating from wall receptacle (AC) power.
8. Verify the **CHARGING STATUS** front panel indicator illuminates for a few minutes.
  - An amber glow indicates the monitor battery is charging.
  - A green glow indicates the monitor batteries are fully charged.

## Graph Test

Using the Trim Knob control, access the *SERVICE MODE* menu starting from the MAIN menu.

1. Select *MORE MENUS -> MONITOR SETUP -> SERVICE MODE ->*
2. Enter password using the Trim Knob control to select the day and month from monitor screen with leading zeros. (e.g. July 4 = 0407).
3. Select *GRAPH TEST PATTERN-> START->*.
4. Verify the following:
  - Fonts.
  - Shading.
  - Triangle Pattern.
  - No missing dots.
5. Select *GRAPH TEST PATTERN-> STOP->*.

## Graph Speed Test

Using the Trim Knob control, access the *GRAPH SETUP* menu starting from the MAIN menu.

1. Select *MORE MENUS -> MONITOR SETUP -> GRAPH SETUP ->*
2. Select *SPEED:25* (default).
3. Verify that all eight speeds work.

## Display Test

1. Hold the **NBP GO/STOP** and the **FUNCTION** keys and press the Trim Knob control *at the same time*.
2. Release the Trim Knob control immediately.
3. Continue holding the **NBP GO/STOP** and the **FUNCTION** keys.
4. Select “Video Test Screens.”
5. Test all screens:
  - White Screen.
  - Red Screen.
  - Blue Screen.
  - Green Screen.
  - Vertical Bars.

## Speaker Test

1. Change the alarm volume of the monitor to 100%.
2. Verify the speaker volume of the monitor changes accordingly.
3. Return the volume of the monitor to the level it was previously set to, before you changed it for this test.

## Network Test

1. Verify that the monitor is connected to the Unity-MC (Mission Critical) network.
2. Select *VIEW OTHER PATIENTS*.
3. Select *SELECT ANOTHER CARE UNIT*.
4. Verify that you can see at least one care unit.
5. Select a care unit.
6. Select *SELECT A BED TO VIEW*.
7. Select a bed.
8. Verify that the patient window appears on the monitor’s split-screen.

## RF LAN Test (option)

1. If the monitor has the Wireless LAN, disconnect the Ethernet cable and verify Wireless LAN communication still exist between beds,
2. Reconnect the Ethernet Cable.
3. Return to the *MAIN MENU*.



## RAC 2A Module Housing Test

Because the RAC 2A module housing has a separate power supply, perform electrical safety tests separate from the monitor.

### Electrical Safety

Refer to the Electrical Safety Tests section of this chapter and complete the following test.

1. Wall Receptacle Test
2. Ground (earth) Continuity Test,
3. Ground (earth) Wire Leakage Tests, and
4. Enclosure Leakage Current Test.

### Operation

To test the RAC 2A module housing for proper operation with your patient monitor complete the following steps:

1. Attach the communications interface cable to the Auto port on the RAC 2A housing and the AUX port of the monitor.
2. Install a SAM module into the RAC 2A module housing.
3. Apply power to the patient monitor and the RAC 2A module housing.
4. Operate the module and check for proper output displayed on the monitor.

## Checkout Procedures Completion

This completes all tests associated with the checkout procedures.

1. Discharge the test patient admitted during the “ECG Tests” on page 4-27.
2. Set all test equipment power switches to the off position.
3. Unplug the monitor from AC power.
4. Remove all test equipment from the monitor.

## PM Form

Due to continuing product innovation and because specifications in this manual are subject to change without notice, a PM form is not included with this manual. For the latest PM form regarding this product, contact GE Medical Systems *Information Technologies* Service.

If repairs/adjustments were made or any parts replaced, describe this in the area provided on the PM form.

Also include comments regarding any unusual environmental conditions that may affect the operation or reliability of the equipment in the area provided on the PM form.

On the following pages a repair log is included for your convenience to record the repair history of this product.

# Repair Log

<b>Unit Serial Number:</b>		
<b>Institution Name:</b>		
Date	Maintenance/Repair	Technician

# 5 TROUBLESHOOTING

*For your notes*

# Service Menus

There are two distinct service menus for the monitor. The *SERVICE MODE* menu is found in the monitor's Main Menu and is used for various functions like calibration, video tests, and downloading monitor interface software. The Boot Loader *SERVICE MENU* is found in the Boot Code and is used when downloading the Boot Code and main processor code.

Both service menus are generally used by qualified field engineers and factory service personnel to troubleshoot, repair, or download new software to the patient monitor.

---

---

**WARNING**

The Boot Loader *SERVICE MENU* and the *SERVICE MODE* menu is intended for qualified personnel only. It is possible to lose patient data, damage the operating software for this monitor, and even affect the Unity Network. Do not 'experiment' with any commands found in the service menus.

---

---

## Boot Loader Service Menu

Use the Boot Loader service menu when downloading new Boot Code or Main Code software to the patient monitor or when the patient monitor exhibits a serious failure. Activate the Boot Loader program as follows:

1. Hold down **NBP Go/Stop** and **Function** on the front panel.
2. Press and release the Trim Knob control.
3. Keep holding **NBP Go/Stop** and **Function** until the Boot Loader information appears on the display.

Following is a list of options in the boot code service menu;

**CHANGE INTERNET ADDRESS**—This menu selection allows changes to the Ethernet address, gateway address, and internet mask.

---

---

**WARNING**

Duplication of an Internet address on a network causes data loss and possible Unity Network problems. If you change the factory assigned Internet address, you must record all other Internet addresses used on your network to avoid duplication.

---

---

**SHOW INSTALL OPTIONS**—This menu lists the options installed on the monitor.

**SET CONFIGURATION**—This menu contains options for configuring the monitor. Refer to Boot Code Selections in the Configuration chapter of this manual.

**SERIAL DOWNLOAD MAIN**—This option is used when downloading

software from a laptop PC.

**SERIAL DOWNLOAD BOOT**—This option is used when downloading software from a laptop PC.

**SERIAL DOWNLOAD DAS MAIN**—This option is used when downloading software from a laptop PC.

**SERIAL DOWNLOAD DAS BOOT**—This option is used when downloading software from a laptop PC.

**SERIAL DOWNLOAD WRITER MAIN**—This option is used when downloading software from a laptop PC.

**SERIAL DOWNLOAD WRITER BOOT**—This option is used when downloading software from a laptop PC.

**VIDEO TEST SCREENS**—Various color screens for testing the display.

**BATTERY SIMULATION**—This option is for engineering use only.

**WAKE UP BATTERY**—This option is used when the battery is dead. See “Error Message” on page 5-11.

**OPTIONS MENU**—A unique password is required for each option. Contact your sales/service representative to obtain a password. You must provide your product serial number and Ethernet address. (The Ethernet address is displayed in the Boot Code banner information.)

## Main Menu Service Mode Menu

The **SERVICE MODE** menu option items provide the user access to several general and technical built-in software functions of the monitor. Only persons responsible for configuring and maintaining the monitor should access the service mode menu option items.

---

---

### WARNING

The Service Mode menu is intended for use only by qualified service technicians. Experimentation with service mode menu option items can be detrimental to the monitor. Lost patient data, damaged operating system software for the monitor, even network related problems are but a few examples of problems that can be induced as the result of tampering with service mode menu option items.

---

---

**Access the Service Mode** Access the *SERVICE MODE* menu starting from the MAIN menu.

1. Select *MORE MENUS* -> *MONITOR SETUP* -> *SERVICE MODE* ->
2. Enter password using the Trim Knob control to select the day and month from monitor screen with leading zeros. (e.g. July 4 = 0407).

MAIN MENU		REVIEW ERRORS	CALIBRATE	BATTERY SERVICE	PATIENT-MONITOR TYPE ADULT-ICU
MENU SETUP	MONITOR SETTINGS				GRAPH TEST PATTERN
					TIME AND DATE

## About Service Mode Menu Option Items

The Service Mode menu is used for initial setup and configuration as well as for troubleshooting. **ALWAYS** exercise caution when using any of these password-protected functions.

The service technician can use the Service Mode menu to:

- ◆ relay software information to design engineers;
- ◆ calibrate and troubleshoot NBP functions of the monitor;
- ◆ set admit menu options, software feature levels and operating mode of the monitor;
- ◆ configure the monitor unit name, bed number and Internet address for use on the network; **and**
- ◆ enter or change the time and date on the monitor.

**Do not** use *any* of these options unless specifically instructed to do so.

---



---

### WARNING

Some of the service mode menu option items are to be used only by qualified service technicians and others are for general use. Because of this, unnecessary tampering with service mode menu option items for experimentation purposes is not recommended by GE Medical Systems *Information Technologies* and may cause a malfunction of the monitor.

---



---

## Service Mode Menu Option Items

Following is a list of options in the main code service menu;

**REVIEW ERRORS**—This menu selection is for advanced troubleshooting by GE Medical Systems *Information Technologies*' engineers. Error log data can be transferred over the network to a central station and then loaded onto a diskette for review. (Review Errors is discussed in greater detail later in this chapter.)

**CALIBRATE**—For checkout or calibration of the noninvasive blood pressure, ECG analog output, BP analog output, CO<sub>2</sub> service, and SAM service menu functions of the monitor.

**BATTERY SERVICE**—This is a complete collection of battery data for troubleshooting the batteries.

**PATIENT-MONITOR TYPE**—Select the type of monitor desired, i.e adult, neonatal or operating room. Refer to Chapter 6, Configuration, for detailed procedures.

---

---

**WARNING**

Changing the patient-monitor type will default the admit function to STANDARD configuration. Different alarms and parameters are activated for each selection.

---

---

**NOTE:** The keypad/remote control is DIDCA programmed for specific monitor types. The error message *WARNING: REMOTE MISMATCHED WITH MONITORING MODE* displays if the monitor and keypad/remote control do not match.

**MENU SETUP**—This menu selection provides the following sub-menus: (Refer to Chapter 6, Configuration, for detailed procedures.)

- **ADMIT MENU: STANDARD**  
This menu selection allows you to determine the function of the patient monitor. The four variables include stationary or ambulatory (telemetry) patient monitoring with a monitor that always stays in one room (STANDARD) or a monitor that moves from room to room (*ROVER*).
- **SOFTWARE LEVEL**  
This menu selection displays the software feature level this monitor is using. It allows setting the level to a lower setting than the software feature level setting in Boot Code.
- **MONITOR DEFAULTS PASSWD**  
This menu selection allows you to set the monitor so that a password is *REQUIRED* or *NOT REQUIRED* for entry into the *MONITOR DEFAULTS* menu section. If selected, the password will be the same as the *SERVICE MODE MENU* password.

**MONITOR SETTINGS**—This menu selection provides the following sub-menus: (Refer to Chapter 6, Configuration, for detailed procedures.)

- **SET UNIT NAME**  
This menu selection allows changes to the care unit name. After initial setup, this name should not be changed or communication to the central station will be corrupted. Note that the care unit name must be registered exactly the same in the central station and the patient monitor.
- **SET BED NUMBER**  
This menu selection allows changes to the bed number. After initial setup, this number should not be changed or communication to the central station will be corrupted. Note that the bed number must be registered exactly the same in the central station and the patient monitor.
- **SET INTERNET ADDRESS**  
This menu selection allows changes to the internet (IP) address.



---

---

**WARNING**

Duplication of an internet (IP) address on a network causes lost data. If you change the factory assigned internet address, you must first record all other internet addresses used on your network to avoid duplication.

---

---

An incorrect internet address may also prevent the monitor from viewing other monitors on the network even though the unit names match. Whether or not this can occur depends on the network topology at the installed site.

**GRAPH TEST PATTERN**—This menu selection allows you to run a graph test pattern. The choices are *START* and *STOP*.

**TIME AND DATE**—This menu selection allows changes to the time and date and may affect the time and date for the entire monitoring network. (Refer to Chapter 6, Configuration, for detailed procedures.)

---

---

**WARNING**

Loss of patient history. This menu should rarely be used because patient histories will be lost.

---

---

## Review Errors

The REVIEW ERRORS menu is an advanced troubleshooting tool used by GE Medical Systems *Information Technologies*' engineering personnel. Some of the information recorded in the monitor error log can be useful for field service troubleshooting.

### About the Monitor Error Log

This section provides an introduction to error log usage and meaning. Because the information contained in the error log is engineering-oriented, the intent of the manual is to simply provide a general understanding of this monitor function.

### Downloading the Error Log

This section includes a method for downloading error log data over the network to a central station. Once downloaded to a central station, you can load the error log data onto floppy diskettes or review it on the central station.

### Accessing the Review Errors Menu Option Item

To access the error log and learn more about the REVIEW ERRORS menu option item, follow these steps:

1. Rotate and press the Trim Knob control to select REVIEW ERRORS from the Service Mode Menu.
2. The review errors menu option items include four possible selections; one each for viewing output or input errors along with one each for clearing output or input errors. Rotate and press the Trim Knob control to scroll to and select VIEW OUTPUT ERRORS from the Review Errors Menu.
3. The RUN TIME ERROR LOG pop-up window appears on the left side of the monitor display. One time-dated output software error appears in the pop-up window at a time.

Use the Trim Knob control to scroll through each logged error and peruse all of the parameters associated with each output software error. Rotate the Trim Knob control to move the cursor (>) to a position for viewing the NEXT or PREVIOUS error as well as the position that allows the user to QUIT viewing output errors.

Selecting QUIT closes the RUN TIME ERROR LOG pop-up window and returns to the Review Errors Menu.

4. The VIEW INPUT ERRORS menu causes a RUN TIME ERROR LOG pop-up window to appear on the monitor display. The pop-up window now displays input software errors and provides basically the same information as the VIEW OUTPUT ERRORS pop-up window provided. The appearance of both pop-up windows are similar, the difference being errors that are logged as input versus output to/from the monitor.
5. To clear out the stored run time error logs, use the Trim Knob control to select the CLEAR OUTPUT ERRORS or CLEAR INPUT ERRORS menu, respectively.

Immediately after you clear one of the error logs, a message appears on the upper right side of the display. The message verifies the actuation of the Trim Knob control for this function.

## Error Log Information

This part of the section describes in greater detail what information the error log contains and what can be learned from error logs.

An error log in the monitor can hold up to 50 events. As an event occurs, error information is stored in the log. Subsequent events are stored sequentially as they occur. When the 50-event limit is reached, subsequent errors replacing the oldest error(s) in the log.

A sample of the monitor error log pop-up window appears as follows:

When using the error log to troubleshoot a problem with the monitor, the following parameters from the pop-up window that are of greatest interest are:

- **PROCESS NAME**—The task that was operating when the event or problem occurred,
- **ERROR CODE**—A software code for the type of event or problem that occurred,
- **SEVERITY**—Indicates the level of impact of the event or problem on the system,
- **DATE**—The date the event or problem occurred,
- **TIME**—The time the event or problem occurred, *and*
- **ERROR NUMBER**—A sequential number used to identify each event or problem.
- **INPUT ERROR**—Additional information used to determine the cause of the error.

## Error Logs

Error logs contain more than just operating system errors. Many events that occur that might have an impact upon the system are entered into the log. These logs may be requested by Tech Support on occasion to aid in troubleshooting the monitor. The logs are developed to aid engineering for internal diagnostics of the monitor. Contact Tech Support if you need clarification of any of the error logs.

## Severity of the Error

Severity is a measure of how the event/error affected the system. There are three levels of severity. The following is a list of these levels accompanied by a brief description of each:

- **CONTINUE**—The event or error was logged, the task may or may not have completed, but the system was able to continue operating. Most error log entries have this severity level.
- **FATAL**—The event or error was logged, the task did not complete, and the system was unable to continue operating as recovery was not possible. This level of severity in an event or error is always followed by an automatic warm start.
- **FORCED RESTART**—The operating system restarted normally after a known condition, such as an Internet address change, patient discharge, etc.

# Battery Alarms and Messages

## Alarm Conditions

Battery alarms occur when the following conditions occur:

- Low Battery,
- Empty Battery,
- Battery Failures, or
- Charger Failures.

Messages Displayed in the ECG Waveform Area	Battery Alarm	Cause
<i>BATTERY LOW</i>	System <i>WARNING</i>	Critical Low Battery—Only 10 minutes per battery of run time remaining (10 minutes if one battery, 20 minutes if two batteries).
<i>POWERING DOWN</i>	System <i>WARNING</i>	Empty Battery—There is no battery run time remaining.
<i>CHECK BATTERY STATUS</i>	System <i>MESSAGE</i>	Battery Failure—A minor failure has occurred while using or charging the battery.
<i>BATTERY ERROR</i>	System <i>WARNING</i>	Battery Failure—A serious failure has occurred while using or charging the battery.
<i>CHECK BATT STATUS</i> <b>NOTE:</b> <i>INTERNAL CHARGER FAILED, CALL SERVICE</i> also appears in the Battery Status information window.	System <i>MESSAGE</i>	Charger Failure—Charger communications have failed.

Messages Displayed in the Battery Status Information Window	Battery Alarm	Cause
<i>INTERNAL CHARGER FAILED, CALL SERVICE</i> <b>NOTE:</b> <i>CHECK BATT STATUS</i> also appears in the ECG waveform area.	System <i>MESSAGE</i>	Charger Failure—Charger communications have failed.
<i>CONDITION</i>	None	Condition —The battery is requesting a conditioning cycle.

## Error Message

Message Displayed in the Battery Fuel Gauge Icon	Reason	Solution
<i>ERROR</i>	The battery is either asleep or faulty.	<p>Complete the following steps to “wake up” a monitor’s battery that has not been used for a period of time.</p> <ol style="list-style-type: none"> <li>1. Hold the <b>NBP Go/Stop</b> and the <b>Function</b> buttons and press the Trim Knob control at the same time.</li> <li>2. Release the Trim Knob control immediately.</li> <li>3. Continue holding the <b>NBP Go/Stop</b> and the <b>Function</b> buttons.</li> <li>4. Disconnect the monitor from the network.</li> <li>5. Select option 12, “<i>Wake up Battery.</i>”</li> <li>6. Place the “sleeping” battery in battery slot “A.”</li> <li>7. Select option 1, “<i>Wake up Lithium ion battery in Slot A.</i>”</li> </ol> <p><b>NOTE:</b> In some languages, slot “A” is identified as slot “1” and slot “B” is identified as slot “2.”</p> <p>If the battery will not “wake up” it is probably faulty and should be replaced.</p>

# Power Source Tests

## Wall Receptacle

Use this procedure to confirm AC power from the wall receptacle which the monitor is plugged into.

Use a digital multimeter (DMM) to verify the wall receptacle is wired correctly. This is accomplished by performing a:

- voltage measurement between all three connections of the wall receptacle;
- ground-to-neutral loop resistance measurement.

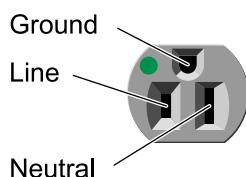

A standard wall receptacle consists of three connections: line, neutral and ground. The figure at left indicates the location of each on a 120 VAC wall receptacle commonly used in the United States. The location and shape of pins may be different on wall receptacles used in countries other than the United States.

Perform the following tests:

1. Use a DMM to measure the voltage between the three connections.
  - Select the AC voltage scale on the DMM.
  - Measure the voltage from line to neutral, line to ground, and neutral to ground and make sure these are correct. With a correctly wired wall receptacle used in the United States, the following readings should be obtained:

Line to neutral: 120 VAC

Line to ground: 120 VAC

Neutral to ground: < 3 VAC

Readings other than these indicate improper wiring. Have the wall receptacle checked by an electrician.

2. Use a DMM to measure the ground-to-neutral loop resistance.

---



---

### CAUTION

DO NOT check the ground-neutral loop resistance unless the wall receptacle is correctly wired.

---



---

- Select the milliohms ( $m\Omega$ ) scale on the DMM.
- Measure resistance across the power cord ground and neutral.
- Measure from the ground lug on the rear power connector to any exposed metal of the monitor. The resistance between the ground and neutral connections, after the ohmmeter is nulled, must be less than 100  $m\Omega$ . If not, have the wall receptacle checked by an electrician.

**Power Cord and Plug** Verify the power cord being used with the monitor is good. The following are a couple of things to check for in this regard:

- Failure of the power cord strain relief is very common. Often times users of the equipment pull on the power cord itself, rather than the power cord plug, to unplug the monitor from a wall receptacle. If in doubt, test for continuity through each conductor of the power cord connector and plug.
- Verify line, neutral, and ground conductors are properly connected to the power cord plug and are not short-circuited. Rewire and tighten these, or replace the power cord, as necessary.

# Data Acquisition Tests

## ECG Functions

1. Connect the MEI Multifunction Microsimulator (pn MARQII) and appropriate patient cables, to the ECG connector of the monitor. Turn the monitor and the patient simulator on.
2. Set the monitor to display leads I, II, III, and V simultaneously:
  - From the main menu, select DISPLAY OPTIONS.
  - Make sure the DISPLAY menu item shows INDIVIDUAL plus six waveforms. If it shows FULL, change it to INDIVIDUAL.
  - Select WAVEFORMS ON/OFF from the menu.
  - Set the displayed waveforms for the following ECG leads:

ECG 1	WAVEFORM 2	WAVEFORM 3	WAVEFORM 4
LEAD II	LEAD V	LEAD I	LEAD III

3. Set the patient simulator to output calibration (cal) pulses at 1.0 mV.
4. Measure the cal pulse (  ) amplitude. These should be (+/-20%):
  - Lead I: 0.5 mV
  - Lead II: 1 mV
  - Lead III: 0.5 mV
  - Lead V: -0.5 mV
5. It may be necessary to run a graph to accurately measure the cal pulses. Perform these steps to graph all four waveforms.
  - From the main menu, select GRAPH & ALARMS.
  - Select GRAPH CONTROL from the menu.
  - Set the graphed waveforms for the following ECG leads:

ECG 1	WAVEFORM 2	WAVEFORM 3	WAVEFORM 4
LEAD II	LEAD V	LEAD I	LEAD III

- Press the GRAPH GO/STOP front panel control on the monitor to start and stop a manual graph.
- Compare the printed graph with the sample shown below.

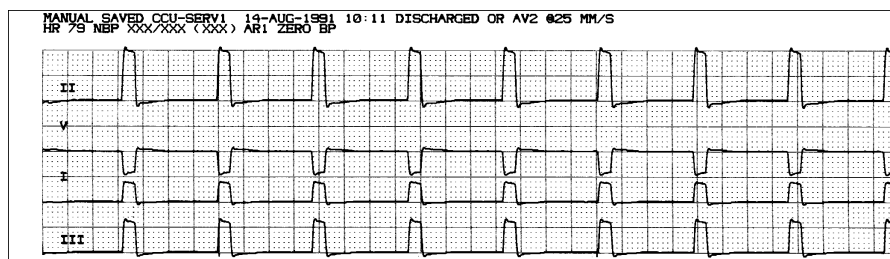



6. Change the patient simulator output from cal pulses to an 80-bpm ECG waveform.
  - The displayed ECG waveforms should be similar to those shown in the figure below.
  - If this is the case, the ECG functions of the acquisition PCB, as well as communication between the acquisition and processor PCBs function as designed.



### ECG Waveforms Display Incorrectly



1. If the calibration pulses are **not** correct, test the patient simulator using a working monitor. If the patient simulator functions as designed, calibrate the acquisition PCB. Refer to Chapter 5, "Calibration."
2. If displayed ECG waveforms contain a significant amount of noise (see figure at left), check the ECG patient cables.
3. Test the patient simulator and ECG patient cables on a working monitor to verify the ECG signal.
4. If the ECG signal, patient simulator and ECG patient cables are good, the acquisition PCB is suspect and you need to replace it.

### ECG Waveforms Do Not Display At All

1. Test the ECG patient cables on a working monitor.
2. Test the patient simulator on a working monitor.
3. Swap the acquisition PCB into a working monitor. If the symptoms follow the PCB into the working monitor, replace the acquisition PCB.
4. If none of these first three steps provide any results, swap the processor PCB and/or power supply PCB into a working monitor.

### Lead Fail Functions

1. With the monitor displaying leads I, II, III, and V from the patient simulator, remove the RA leadwire from the patient simulator.
2. The monitor should display a warning of a RA FAIL message. Lead fail detection functions properly if this is the case. Lead fail detection does not function properly if this is **not** the case. The acquisition PCB is suspect. Swap the PCB with a working monitor to verify the malfunction.
3. Reattach the RA leadwire to the patient simulator.

## Pace Detect Functions

1. With the monitor displaying leads I, II, III, and V, set the patient simulator to output a VP1 (ventricular pacemaker simulation #1) waveform.
2. Enable the pacemaker detection function of the monitor:
  - select ECG from the display main menu,
  - select DETECT PACE and set to PACE 2.
3. Verify the heart rate remains at approximately 80 bpm.
4. Select the VP2 output (ventricular pacemaker simulation #2) on the patient simulator.
5. Select and press RELEARN.

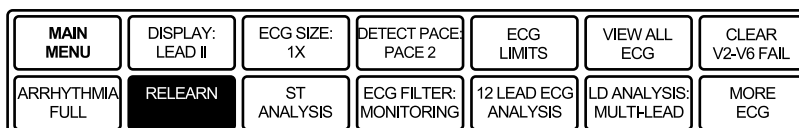

6. The heart rate number may disappear from the display for a few seconds and return to the screen shortly thereafter. Verify the heart rate is at approximately 80 bpm. Verify the pacemaker spikes display at the same amplitude.
7. Disable the pacemaker detection function of the monitor. Verify the displayed pacemaker spikes have a different amplitude than in the previous step.
8. Select the AVS output (A/V sequential pacemaker simulation) on the patient simulator.
9. Select and press RELEARN.
10. Verify the displayed pacemaker spikes are at different amplitudes.
11. Select and press RELEARN.
12. Enable the pacemaker detection function of the monitor once again.
13. Set ECG GAIN to X2.
14. Verify a stable heart rate display of approximately 80 bpm. Verify the pacemaker spikes are again at the same amplitude.
15. Disable the pacemaker detection function of the monitor.

### Pace Detect Functions Do Not Work Properly

If the pacemaker detection test results are not correct, as described above:

- Verify the patient simulator functions correctly by testing it on a working monitor,
- The acquisition PCB is suspect. Swap a working acquisition PCB into the monitor and perform this test to verify correct operation.

## Invasive Blood Pressure Functions

The invasive blood pressure (BP) test procedure requires the use of the following patient simulator: MEI Multifunction Microsimulator (pn. MARQII). If you need to use a different patient simulator, adjust the procedure steps/readings accordingly.

### Setup BP1

Connect the BLOOD PRESSURE 1 output of the patient simulator to the P1 patient connector on the side panel of the monitor.

### Setup BP2

Connect the BLOOD PRESSURE 2 output of the patient simulator to the P2 patient connector on the side panel of the monitor.

### Zero-Reference Both BP's

Properly zero-reference each BP input:

- Set the patient simulator BP output to 0 mmHg
- Press the FUNCTION front panel control on the monitor.

### Generate Dynamic BP Waveforms

Set the patient simulator BP output to WAVE.

Setup the BP scales on the monitor for auto gain:

- Select AR1 from the main menu of the monitor
- Select ART SCALES from the AR1 menu
- Select AUTO gain from the ART SCALES menu
- Return to the main menu of the monitor and setup auto gain for the PA2 waveform as you did for AR1.

### Verify Dynamic BP Results

Once the BP waveforms are setup as described above verify the following:

- Both the AR1 and PA2 BP waveforms are noise-free, as shown in the figure at the left.
- BP displayed parameters are within tolerance as indicated in the following list:

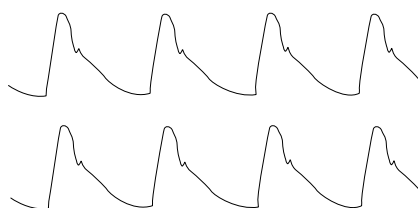

BP Parameter:	AR1	PA2
Systolic (mmHg):	116 – 124	28 – 32
Diastolic (mmHg):	78 – 82	9 – 11

**NOTE:** These tests are designed for use with a MEI Multifunction Microsimulator, pn. MARQII. Accuracy specifications of the patient simulator in combination with the monitor ( $\pm 2\%$  or 1 mmHg, whichever is greater) is how the parameter values listed above, were derived. Use of any other manufacturer patient simulator, and associated specifications, can potentially change these test results.

## Generate Static BP Waveforms

Set the patient simulator BP output to 200 mmHg, static pressure.

- Verify the BP1 channel is working correctly if systolic, diastolic, and mean pressure values for AR1 are displaying parameter readings between 194 and 206 mmHg. Remove the cable from BP1 and install it in BP2 and repeat the test.

## BP Waveforms Do Not Appear Correctly On The Display



1. If the BP waveforms displayed on the monitor appear noisy or distorted (example shown on the left), test the Patient simulator and simulator test cables and on a working monitor to determine the source of the problem.
2. If the static pressure test results were inaccurate, test the Patient simulator and simulator test cables and on a working monitor to determine the source of the problem.
3. If the patient simulator and associated test cables are determined to be functioning correctly, the acquisition PCB is suspect. Swap the acquisition PCB into a working monitor to determine if replacement is necessary.

## BP Waveforms Do Not Appear On The Display At All

1. If the AR1 or PA2 parameter labels, readings and associated waveforms do not display on the monitor, verify the patient simulator and associated test cables on a working monitor.
2. Inspect the BP side panel connectors on the monitor for bent or broken pins. If any pins are bent or broken, replace the DAS assembly.
3. Perform continuity tests between the side panel connectors of the monitor, front panel flex circuit assembly located behind the front panel connectors, and connection to the acquisition PCB.
4. If the patient simulator and associated test cables function correctly and the continuity tests yield no malfunction, the DAS assembly is suspect. Swap the DAS assembly into a working monitor to determine if a replacement is necessary.

## Respiration Functions

Connect the MEI Multifunction Microsimulator, pn. MARQII, and appropriate patient cables to the ECG/RESP side panel connector on the monitor.

1. Adjust the patient simulator to output a respiration waveform using the following settings:
  - Rate BPM – 30
  - Baseline Impedance Ohms – 750,
  - $\Delta R$  Ohms – 2.0.
2. Enable the respiration function of the monitor:
  - Select MONITOR SETUP from the main menu display on the monitor,
  - Select PARAMETERS ON/OFF from the monitor setup menu.

Next, turn and push the Trim Knob control to:

- scroll to and select RR in the parameters on/off pop-up window.
- toggle and select ON in the RR line of the parameters on/off pop-up window.

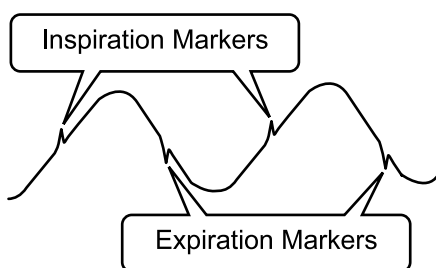

Verify the following:

- Respiration rate is displayed and accurate.
- Respiration waveform is displayed and noise-free.
- Markers appear in the displayed respiration waveform (see figure at left). These indicate the points at which the monitor senses inspiration and expiration for determination of the respiration rate.

### No Respiration Waveform or Rate Appear on the Display

If the respiration waveform or rate does not appear on the monitor display, perform the following steps to isolate the problem:

- Vary the baseline impedance on the patient simulator
- Vary the  $\Delta R$  on the patient simulator.
- Test the patient simulator and appropriate patient cables on a working monitor to determine the source of the problem.
- If none of the previous recommendations corrects the problem, the acquisition PCB is suspect. Swap the PCB into a working monitor to determine the source of the problem and replace as necessary.

### Markers do not Appear on Respiration Waveform; Respiration Rate is Inaccurate

If the markers on the respiration waveform do not appear on the display or the respiration rate count is inaccurate, try changing the respiration sensitivity level on the monitor. Use the Trim Knob control on the monitor to:

- Scroll to and select RR (respiration parameter) from the monitor main menu,
- Scroll to and select SENSITIVITY from the respiration parameter menu, and
- Scroll to and select a different sensitivity percentage (%) from the sensitivity menu

**NOTE:** Usually, a lower respiration sensitivity% level rectifies this problem.

### Respiration Functions Work Properly on Patient Simulator but not on Actual Patient



Refer to the *Operator's Manual* for detailed information regarding patient preparation relative to respiration monitoring functions. Achieving optimum results for respiration waveforms and accurate respiration rate detection by the monitor requires proper preparation for ECG electrode placement on the patient. An example of a noisy respiration waveform, usually due to bad patient preparation, is shown at the left.

**NOTE:** With patients that exhibit excessively high baseline chest impedance, proper respiration monitoring can be extremely difficult, if not impossible.

## Noninvasive Blood Pressure Functions

Perform the noninvasive blood pressure (NBP) Checkout Procedure found in the Maintenance chapter. This procedure determines whether or not the NBP functions of the monitor are working as designed or whether the monitor requires NBP calibration.

If, after performing the prescribed checkout procedure, it is determined that there are potential problems that NBP calibration does not cure, try the following:

1. If calibration is unsuccessful and cannot be properly performed, there could be leaks in the pneumatic circuit plumbing. The following steps assist you in determining this:
  - The NBP cuff and tubing is the easiest area to inspect for leaks and is also the most likely area for failure in this regard. Closely inspect these items for cracks or leaks. Test the NBP cuff and tubing on a working monitor to determine the source of the problem.
  - If the NBP cuff and tubing are determined to be good after testing them on a working monitor, the leaks are probably internal to the monitor. Disassemble the monitor and check inspect all internal tubing and connections in the pneumatic circuit plumbing.
2. If no leaks are found after performing the previous step, the NBP pump assembly is suspect. Swap the NBP pump assembly with one from a working monitor and/or replace as necessary.

## NBP Alarms Occur Continuously

If the monitor is not configured properly, a variety of NBP problems may occur. To determine monitor configuration, rotate then push the Trim Knob control to:

- Scroll to and select CUSTOMIZE MONITOR from the main menu of the monitor,
- Scroll to and select PATIENT-MONITOR TYPE from the customize monitor menu of the monitor.

Verify the configured monitor type matches the environment in which the monitor is being used. If it is set to a neonatal ICU when the monitor is used for the adult ICU application or vice versa, problems listed to the left may occur.

# Wireless LAN Troubleshooting

Problems may occur with network communications while the monitor is communicating over Wireless LAN. Following is a list of possible solutions when troubleshooting Wireless LAN.

- If the monitor can not be viewed at the central station or can not view other monitors, it may not be communicating with the internal RF card.
  1. Check the status of the Wireless LAN communication:
    - a. Select *REVISION AND ID* option from the Monitor Setup Menu.
    - b. There are three pages of software revision information. Select *NEXT* to display the second page of information.
    - c. Select *NEXT* twice to display the Hardware ID Display information window.
    - d. Verify the *WIRELESS LAN ID* shows the proper country, status, revision and date code. For example: US 02 V4.63 00022.
  2. If there is no *WIRELESS LAN ID*, the card may be disabled or inoperative. Verify the card is enabled:
    - a. Activate the Boot Code by holding down **NBP Go/Stop** and **Function**.
    - b. Press and release the Trim Knob control.
    - c. Keep holding **NBP Go/Stop** and **Function** until the Boot Code information appears on the display.
    - d. Select *Service Menu* -> *Set Configuration* -> *Configure Wireless LAN* -> *Enable / Disable Wireless LAN*.
  3. The monitor is configured with international roaming. The country abbreviation code (**US 02 V4.63 00022**) must match the country the monitor is in. If the code does not match:
    - ◆ Check to make sure the correct Access Point is installed.
    - ◆ Refer to the Wireless LAN (Symbol Access Point) Installation and Service Manual for details on proper Access Point installation.



- The most common cause of non-communication is an incorrect SSID. If the communication status in the Wireless LAN ID is 01 (US 01 V4.63 00022), the RF LAN card is not communicating with the Access Point. The SSID must match the Access Point's NET ID.
  1. To change the SSID status:
    - a. Activate the Boot Code by holding down **NBP Go/Stop** and **Function**.
    - b. Press and release the Trim Knob control.
    - c. Keep holding **NBP Go/Stop** and **Function** until the Boot Code information appears on the display.
    - d. Select *Service Menu* -> *Set Configuration* -> *Configure Wireless LAN* -> *Change SSID*.
  - NOTE:** For all standard installations, the SSID should be GEMS (default).
  2. If the status is 02, the RF LAN card is communicating with the Access Point and the network should be available.
    - ◆ Check the network connection to the Access Point.
    - ◆ Refer to the Wireless LAN (Symbol Access Point) Installation and Service Manual for details on proper Access Point installation.
- Intermittent communication may be caused if the monitor is out of range or there is RF interference.
  - ◆ If the monitor is out of range, add additional Access Points to extend the coverage area.
  - ◆ If there is RF interference, the source of the interference must be removed or shielded.

## Service Tips

### Fault/Symptom Analysis

This information is provided for the benefit of service technicians responsible for the maintenance and repair of the monitor. The symptoms covered in this part of the Troubleshooting section represent only a select number of faults that you may encounter and by no means are intended to cover every possible failure that may occur.

A systematic approach to the diagnosis of problems as well as a general understanding of the architecture, both hardware and software, of the monitor are essential to ensure successful troubleshooting of this device. The manufacturer recommends formal service training before repairs are attempted on the monitor. The Service Tips listed below combined with formal training should provide the service technician with skills necessary to service and repair a monitor, in the event of a malfunction.

Problem	Reason	Solution
<b>General Problems</b> <b>The unit is plugged in, but it does not switch to AC from Battery power.</b>	<ul style="list-style-type: none"> <li>■ The output voltage of the power supply is inadequate for the processor PCB to recognize.</li> </ul>	<ul style="list-style-type: none"> <li>■ Replace the power supply.</li> <li>■ Replace the processor/power management assembly.</li> </ul>
<b>Audio Problems</b> <b>Audio does not sound. Go to the Alarm Help Menu and select “Crisis.” Listen for the three-beep audio.</b>	<ul style="list-style-type: none"> <li>■ The speaker cable is loose or disconnected.</li> <li>■ The speaker failed.</li> <li>■ The audio circuit on the processor PCB failed.</li> </ul>	<ul style="list-style-type: none"> <li>■ Restore the cable connections.</li> <li>■ Replace the speaker.</li> <li>■ Replace the processor/power management assembly.</li> </ul>
<b>Optional Writer Problems</b> <b>No paper comes out, even though “Graphing” is displayed.</b>	<ul style="list-style-type: none"> <li>■ Graph locations are set incorrectly.</li> </ul>	<ul style="list-style-type: none"> <li>■ With the Trim Knob control, select MONITOR GRAPH SETUP, and GRAPH LOCATION. Verify that MANUAL, ALARM, and PRINT locations are set properly.</li> </ul>
<b>Paper comes out, but no graph data is shown.</b>	<ul style="list-style-type: none"> <li>■ The paper may be loaded incorrectly.</li> <li>■ Print head may be dirty or defective.</li> </ul>	<ul style="list-style-type: none"> <li>■ See the <i>Operator Manual</i> for correct paper installation.</li> <li>■ Clean the printhead (refer to the maintenance chapter of this manual).</li> <li>■ Perform a graph test. If problem persists, replace the writer assembly.</li> </ul>
<b>Saving Message</b>	<ul style="list-style-type: none"> <li>■ Writer is busy.</li> <li>■ Writer is no longer available.</li> </ul>	<ul style="list-style-type: none"> <li>■ When the graph is complete, the saved graph prints out.</li> <li>■ Check the graph locations. Set the correct graph locations if necessary.</li> </ul>
<b>Missing segments in the graph data.</b>	<ul style="list-style-type: none"> <li>■ Print head may be dirty or defective.</li> </ul>	<ul style="list-style-type: none"> <li>■ Clean the printhead (refer to the maintenance chapter of this manual).</li> <li>■ Perform a graph test. If problem persists, replace the writer assembly.</li> </ul>

Problem	Reason	Solution
<b>Optional Alarm Light</b>		
<b>The red or yellow lights do not light on boot up of the monitor.</b>	<ul style="list-style-type: none"> <li>■ Cable may be loose or disconnected.</li> <li>■ LEDs are burned out.</li> </ul>	<ul style="list-style-type: none"> <li>■ Restore the connection.</li> <li>■ Replace the alarm light assembly or PCB.</li> </ul>
<b>Defib Sync Problems</b>		
<b>“Buzz” signal comes out for ECG or BP.</b>	<ul style="list-style-type: none"> <li>■ BP is not zeroed.</li> <li>■ BP is not available.</li> <li>■ ECG leads fail.</li> </ul>	<ul style="list-style-type: none"> <li>■ Zero out the BP.</li> <li>■ Plug in a BP cable.</li> <li>■ Check patient connections.</li> </ul>
<b>Video Display Problems</b>		
<p><b>There are bars/strips of pixels missing on the display in rows/columns. Or only one row/column of pixels on the display is missing or never turned on. The remaining portion of the display functions properly.</b></p> <p><b>No display</b></p>	<ul style="list-style-type: none"> <li>■ Possible burned-out pixels.</li> <li>■ Display may be in standby mode.</li> <li>■ Backlight inverted may be defective.</li> </ul>	<ul style="list-style-type: none"> <li>■ Run the display tests in the boot loader.</li> <li>■ Replace the display assembly.</li> <li>■ Press the Power button. If display still does not appear within 10 seconds, replace the display assembly.</li> <li>■ Replace back light inverter.</li> </ul>

## Acquisition PCB Symptoms

Symptoms relative to patient signal acquisition such as missing parameter text and waveform(s) may be associated with acquisition PCB failure. It is important that you are able to distinguish the difference between the general format of the display, which is generated by the processor PCB, versus the patient signals and data that is associated with these patient signals, a function of data acquisition, which is generated by the acquisition PCB.

## Processor PCB Symptoms

Symptoms with battery operation, network communications, asynchronous communications, NBP control, PCMCIA communications, analog output, audio/sound generation, and video signals as well as other display-related problems all may be associated with processor PCB failure. All of these are functions controlled by microcontroller or graphics processing circuitry located on the Processor/Power Management PCB.

# Troubleshooting Software Updates - Problems and Solutions

The following is a list of problems commonly encountered during a software update with their solutions.

Problem	Possible Reason/Solution
<p><b>Centralscope central station contains the software, but the monitor cannot find it.</b></p>	<p>The Centralscope central station has loaded the monitor software onto its hard drive, but the monitor does not see the central station on the network. There are two ways to get the central station to broadcast across the network.</p> <ul style="list-style-type: none"> <li>■ If patient monitoring may be interrupted, press the CTRL, ALT, and DELETE (backspace) keys simultaneously to reboot the central station.</li> <li>■ If the central station is monitoring patients, do the following:               <ol style="list-style-type: none"> <li>1. At the central station, starting from the MAIN menu select <i>CENTRAL SETUP</i> -&gt; <i>SERVICE</i> -&gt;</li> <li>2. Enter Password <b>MEI CS 123</b>.</li> <li>3. Select <i>SERVICE MONITOR</i>.</li> <li>4. Type <i>ps eaglefs</i> (case sensitive) and press <b>ENTER</b>. Enabling the EAGLEFS program that teaches your central station how to broadcast the software on the network. The central station will respond in one of two ways:                   <ul style="list-style-type: none"> <li>■ If the central station is not running EAGLEFS, it will respond with: <i>INVALID PROCESS ID OR NAME</i>. Type <i>run eaglefs HDØ</i> (case sensitive) and press <b>ENTER</b>.</li> <li>■ If the central station lists EAGLEFS as a running process, go to the next step.</li> </ul> </li> <li>5. Press <b>MAIN MENU</b> on the front panel to exit the <i>SERVICE MONITOR</i> and go back to the monitor to download the software.</li> </ol> </li> </ul>

Problem	Possible Reason/Solution
<p><b>Monitor appears 'locked up' during a network download.</b></p>	<p style="text-align: center;">=====</p> <p style="text-align: center;"><b>CAUTION</b></p> <p style="text-align: center;">Do not power cycle or reboot the monitor if downloading the Boot Code is proceeding normally. The monitor will be rendered useless.</p> <p style="text-align: center;">=====</p> <p>If the packet or byte numbers stop advancing for at least two minutes, do the following:</p> <ol style="list-style-type: none"> <li>1. Check that all cables are properly connected.</li> <li>2. At the patient monitor: <ul style="list-style-type: none"> <li>■ Hold down <b>NBP Go/Stop</b> and <b>Function</b>.</li> <li>■ Press and release the Trim Knob control.</li> <li>■ Keep holding <b>NBP Go/Stop</b> and <b>Function</b> until the Boot Code information appears on the display.</li> </ul> </li> <li>3. Repeat the software update procedure for the aborted file from the beginning.</li> </ol>
<p><b>A:/&gt; prompt does not appear at the PC</b></p>	<p>Select the correct disk drive on the PC to get the <b>A:/&gt;</b> prompt. Many laptop PCs have a switch that allows a single disk drive to emulate two disk drives. Set the drive switch to A and then press the <b>CTRL, ALT, and DELETE</b> keys simultaneously to reboot the PC.</p>
<p><b>Monitor appears 'locked up' during a PC download</b></p>	<p style="text-align: center;">=====</p> <p style="text-align: center;"><b>CAUTION</b></p> <p style="text-align: center;">Do not power cycle or reboot the monitor if downloading the Boot Code is proceeding normally. The monitor will be rendered useless.</p> <p style="text-align: center;">=====</p> <p>If the packet or byte numbers stop advancing for at least two minutes, do the following:</p> <ol style="list-style-type: none"> <li>1. Check that all cables are properly connected.</li> <li>2. Press the <b>ESC</b> key on the PC and the update will continue.</li> <li>3. Select <b>ABORT</b> on the monitor or power cycle the monitor.</li> <li>4. Repeat the software update procedure for the aborted file from the beginning.</li> </ol>
<p><b>Software revision window does not list part numbers.</b></p>	<p>If the part numbers are not listed for the monitor interfaces in the software revision window, the software update has not been activated. power cycle the monitor and view the software revisions window again. If the part numbers are still missing, repeat the update procedure for each missing file.</p>

Problem	Possible Reason/Solution
<p><b>Waveforms do not appear at the central station.</b></p>	<p>If communication is corrupted, do the following:</p> <ol style="list-style-type: none"> <li>1. Check all cables for a good connection.</li> <li>2. Ensure that the central station software is correct.</li> <li>3. Ensure Ethernet addresses have been programmed correctly. Refer to the appropriate service manual.</li> <li>4. Ensure the Ethernet address has been programmed correctly at the patient monitor: <ul style="list-style-type: none"> <li>■ Hold down <b>NBP Go/Stop</b> and <b>Function</b>.</li> <li>■ Press and release the Trim Knob control.</li> <li>■ Keep holding <b>NBP Go/Stop</b> and <b>Function</b> until the Boot Code information appears on the display.</li> <li>■ The Ethernet address displays in the Boot Code banner information.</li> </ul> </li> <li>5. If the Ethernet address needs to be changed in Boot Code, a unique password is required to access <i>Change Ethernet Address</i> in the <i>Options Menu</i>.   Fax a password request to GE Medical Systems <i>Information Technologies</i>' Software Upgrade Coordinator at (414) 362-3250 to obtain a password. You will need to provide your product serial number and Ethernet address. (The Ethernet address displays in the Boot Code banner information.)</li> </ol>

## Error Messages

The following table describes error messages that may appear on the display and how to resolve the problem.

Message	Possible Reason/Solution
<p><i>“WARNING: The EEPROM data was found to be either INVALID or uninitialized. GE Marquette factory defaults will be stored in both the EEPROM and the monitor’s configuration memory. You will be required to re-enter the network configuration, re-enable any password protected features and restore all monitor settings and site-specific defaults.”</i></p>	<p>Following the EEPROM dump, restore data:</p> <ol style="list-style-type: none"> <li>1. Restore Ethernet address and IP address as requested by the Boot Code.</li> <li>2. Power cycle.</li> <li>3. If error message persists, replace processor pcb. If error message no longer occurs, re-enable any password protected features and restore all monitor settings and site-specific defaults via <i>SERVICE MENU -&gt; Set Configuration, and Options Menu.</i></li> </ol>
<p><i>“ERROR: THE INTERNAL BATTERY THAT MAINTAINS THE MONITOR’S DEFAULTS HAS FAILED!”</i>  <i>** SERVICE MAY BE REQUIRED **</i></p>	<p>Battery may be depleted.            Replace the processor pcb.</p>
<p><i>“WARNING: THIS VERSION OF BOOT CODE IS NOT COMPATIBLE WITH THE VERSION OF MAIN CODE CURRENTLY STORED IN FLASH. PLEASE UPDATE THE BOOT CODE.”</i></p>	<ol style="list-style-type: none"> <li>1. Power cycle.</li> <li>2. Reload Boot Code.</li> <li>3. If problems persists, replace processor pcb.</li> </ol>
<p><i>“Boot Flash test FAILED.”</i>  <i>“ERROR: The Boot Code stored in Flash is not valid. Main Code cannot be loaded until valid Boot Code exists.”</i></p>	<ol style="list-style-type: none"> <li>1. Power cycle.</li> <li>2. Reload Boot Code.</li> <li>3. If problems persists, replace processor pcb.</li> </ol>
<p><i>“Main Flash test FAILED.”</i>  <i>“ERROR: The Main Code stored in flash is not valid.”</i></p>	<ol style="list-style-type: none"> <li>1. Power cycle.</li> <li>2. Reload Main Code.</li> <li>3. If problems persists, replace processor pcb.</li> </ol>
<p><i>“Static RAM test FAILED.”</i>  <i>“ERROR: The SRAM memory test failed. Main Code will not be loaded unless this test passes. Reboot the monitor to repeat testing.”</i></p>	<p>Replace processor pcb.</p>
<p><i>“Real Time Clock FAILED - will not start.”</i>  <i>“WARNING: The real time clock chip is not running. Main Code cannot be loaded until this chip is started. Attempting to start real time clock...”</i>            Followed by either  <i>“The real time clock was started. Select Start Patient Monitoring to load and execute Main Code.”</i>            Or  <i>“ERROR: Unable to start the real time clock.”</i></p>	<p>If problem persists and error message displays, replace processor pcb.</p>





# 6 CONFIGURATION

CONFIGURATION:

---

*For your notes*

# Loading Software

## Intended Use

This section is for the purpose of loading manufacturer software into the monitor initially, reloading software when the possibility of corrupted software exists, or updating software with a new software revision.

## Software Loading/ Updating Methods

The process of loading or updating software in the monitor is described in this section. You can load manufacturer software into the monitor using either of these two methods:

### From Diskette

- Connect the monitor directly to a personal computer (PC) or PC laptop. Run the Update Program off of the update diskettes and download the software to the monitor via serial communication.

**NOTE:** You must use the cables included in the Download kit. See “Load Software From Diskette” on page 6-7.

### Over the Network

- For the monitor connected to a patient monitoring network, load the software from the update diskettes onto a Centralscope central station or a Clinical Information Center (CIC). The central station or CIC then acts as a network file server and you then download software to the monitor over the network.

---



---

### NOTES

It is recommended that you use AC power during the software download. If you use battery power and run out of power, you cannot complete the download procedure and may need to return the monitor to the manufacturer for service.

Each method of downloading software to the monitor is distinctly different. *Completely* read **all** of this part of the section prior to any attempt to load or update software. This is particularly important if this is a first attempt to load or update software in the monitor.

---



---

## Software Compatibility

Write down or print out software code part numbers from the *REVISION AND ID* window for each monitor in the system. To print the *REVISION AND ID* table from each monitor, use the Trim Knob control to select the following menu option items from the monitor's Main Menu:

*MONITOR SETUP*,  
*REVISION AND ID*,  
press the **Graph Go/Stop** key.  
*NEXT*, then  
press the **Graph Go/Stop** key.

If a previous revision of software resides in the monitor memory, update the monitor as necessary. Keep the monitor at current levels of manufacturer software to maintain the proper network communication and to provide the user with all of the latest operational features that the manufacturer offers.

The boot code components (main boot, DAS boot, etc.), which reside in various monitor memory locations, play a minor role with regard to actual patient monitoring functions. These boot codes are designed to be updated very infrequently — if ever.

**NOTE:** Boot code components of the monitor software should be updated only when absolutely necessary.

---

---

### CAUTION

If a failure occurs in the update process while loading one of the boot code components, full or partial patient monitoring capability is lost. The monitor is rendered useless and requires service by a manufacturer technical support engineer.

---

---

## Monitor Software Files

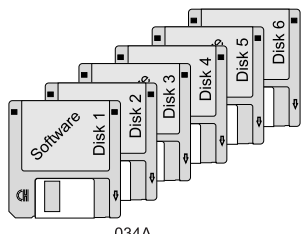

All software files for the monitor are contained on six diskettes included with a manufacturer software update kit. The functional characteristic of files that can be updated is listed below (in the order by which these must be downloaded to the monitor) along with the respective representation from the monitor REVISION AND ID table:

- Main processor op-code (MAIN SW REVISION),
- Acquisition processor op-code (DAS SW REVISION),
- Main processor boot code (MAIN BOOT SW REVISION), and
- Acquisition processor boot code (DAS BOOT SW REVISION).

## Maintain Patient Monitoring

**Do not** download new code with the monitor connected to a patient. Inform medical staff responsible for patients connected to the monitor that you are updating the equipment so they may take appropriate actions.

---

---

### WARNING

There is a temporary loss of monitoring functions throughout various parts of the patient monitoring system until the update is complete on each monitor in the system. Medical staff should be prepared to cover patients in need during these periods of lost monitoring functions.

---

---

To transfer a patient from one bed to another, refer to the “How To...” chapter of the *GE Marquette Unity Network User's Manual*, pn 403799-023. If one is available, have the medical staff transfer the patient to a spare monitor while you load or update software.

---

---

### CAUTION

Patient Histories, Trends, and Vitals are lost after the upgrade. Notify hospital staff to print out data before you start the upgrade.

---

---

## Problems While Loading Software

If problems result while loading software into the monitor:

- Restart the procedure from the beginning,
- For monitors connected to patient monitoring network, refer to the *GE Marquette Unity Network User's Manual*, pn 403799-023, or
- Contact manufacturer technical support at one of the following telephone numbers:

1-800-558-7044 — within the United States, or

1-407-575-5000 — outside of the United States.

## Record Defaults

Print or record the monitor defaults before you upgrade the software and re-enter the monitor defaults when you finish the upgrade. This data may be lost during the software upgrade.

# Load Software From Diskette

**About the Procedure** This procedure describes how to update software in the monitor from a PC or PC laptop floppy disk drive using update diskettes provided in the manufacturer software update kits.

This update procedure requires the following:

1. PC or PC laptop, to download software, with the following minimum requirements:
  - MS-DOS compatible,
  - 1.4M, 3.5-inch floppy disk drive, and
  - RS-232C serial port.
2. Download kit, pn 2000453-001, including:
  - Monitor cable assembly, pn 418335-002, and
  - PC cable assembly, pn 420915-013.
3. Manufacturer software update diskettes.

## Connect the PC to the Monitor

Connect the PC to the monitor by following these steps:

1. Attach the monitor cable assembly to the RJ-45 connector labeled AUX (RS-232) on the monitor's back panel.
2. Connect the PC cable assembly from the RS-232C to the D-type connector at the back of the PC.

## Software Diskettes

The software media consists of six 3.5-inch high density (HD) floppy diskettes.

Diskettes 1, 2, and 3 contain programs and files for downloading software to the monitor over the network. See “Load Software Over The Network” on page 6-13.

Diskette 4, used for this procedure, contains the update program utility along with update files for:

- Main processor boot code,
- DAS processor boot code, and
- Main processor operational code (part 1).

Diskette 5, also used for this procedure, contains the update program utility along with the update file for:

- Main processor operational code (part 2).
- DAS processor operational code.

Diskette 6, also used for this procedure, contains the update program utility along with the update file for:

- Main processor operational code (part 3).



## Update Program Start-up

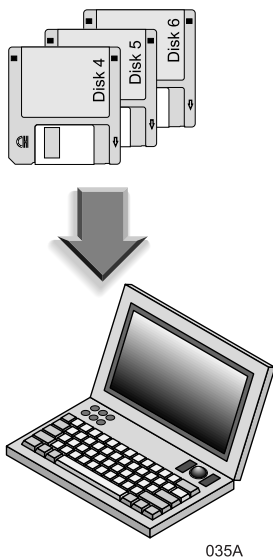

Start the update download program from an update diskette to begin loading software into the monitor by following these steps:

1. Apply power to the PC and wait for the `C:\>` prompt to appear on the PC display.

---

---

### CAUTION

The manufacturer recommends operating the PC (or PC laptop) on AC power for the duration of the update process. This prevents inadvertent power interruptions to the PC or PC laptop. Interruptions of power cause the update process to fail. While you download the boot code components, interruptions in the update process may result in monitor malfunction or the monitor rendered completely useless. The monitor may require factory service as a result.

---

---

2. If the PC used for this procedure automatically launches any version of Windows, perform the necessary steps to quit Windows and return to DOS.
  - Upgrade does not perform correctly under the simulated MS-DOS. Exit out of Windows to a DOS prompt.
  - Do not use Windows NT, since it does not allow an option to exit to DOS.
3. Compare the REVISION AND ID window with the file names from the tables on the next page. Only load the files that currently reflect earlier revisions, as compared with the REVISION AND ID printout, into the monitor. Generally, the main processor operational code (MAIN SW REVISION) or acquisition processor operational code (DAS SW REVISION) need to be updated. Depending on the vintage of the monitor, boot code may need to be updated as well but this is generally not the case.
4. Following is the order in which the update files are to be downloaded:
  - Main processor op-code (MAIN SW REVISION) and
  - DAS processor op-code (DAS SW REVISION).

Then, only if necessary:

- Main processor boot code (MAIN BOOT SW REVISION) and
- DAS processor boot code (DAS BOOT SW REVISION).

## Files on Diskette 4

Below is the list of update files typically found on Diskette 4.

— Diskette 4 —	
File Name	Description
42226900.2A1	MAIN BOOT
42227000.2A1	DAS BOOT
42222800.2A1	MAIN OP (1)

## Files on Diskette 5

Below is a list with the update files typically found on Diskette 5.

— Diskette 5 —	
File Name	Description
42223100.2A1	DAS OP
42222800.2A2	MAIN OP (2)

**NOTE:** The update file included on diskette 5 for other language update kits reflects a different file name than that shown in the list for each language of update kit ordered.

## Files on Diskette 6

Below is a list with the update files typically found on Diskette 6.

— Diskette 6 —	
File Name	Description
42222800.2A3	MAIN OP (3)
42222800.2A4	MAIN OP (4)

5. Insert the diskette containing the specific software to be loaded or updated in the monitor into the PC floppy disk drive.
6. Type **A:** at the **C:\>** prompt and press ENTER on the PC keyboard to change directories to the floppy drive. Then type **update** at the **A:\>** prompt and press ENTER on the PC keyboard to launch the update program. The UPDATE UTILITIES menu appears on the PC display.

**NOTE:** Some computers may have a RETURN key rather than an ENTER key.

7. Press F2 on the PC keyboard to select UPDATE BEDSIDE from the update utilities menu. The UPDATE BEDSIDE utilities menu appears on the PC display.

## Setup Monitor To Accept Download Files

The PC and the monitor communicate serially. The following steps describe how to download a specific file into monitor memory. In order to proceed, the monitor must be enabled to receive update files. Follow these steps to enable the monitor for download, then select and load a specific file to the monitor.

1. At the monitor, activate the BOOT LOADER program by following these steps:
  - Hold down the **NBP Go/Stop** and **Function** keys,
  - Press and release the Trim Knob control,
  - Hold down the **NBP Go/Stop** and **Function** keys until the BOOT LOADER menu appears on the monitor display.
2. In this step, one of two situations is present:
  - For a monitor **not connected** to a patient monitoring network, the BOOT LOADER takes approximately 30 seconds to activate and the SERVICE MENU appears on the monitor display. If this is the case, proceed to the next step.
  - For a monitor **connected** to a patient monitoring network, use the Trim Knob control to scroll to and select the number corresponding to Service Menu from the FILE SERVER SELECTION menu. The SERVICE MENU appears on the monitor display.
3. Decide which code to download to the monitor based on software revision comparisons made earlier in the procedure. Use the Trim Knob control to select the number corresponding to the Serial Download routine for the file requiring update.

**NOTE:** A warning message and prompt appears on the monitor display. Use the Trim Knob control to select YES to proceed with the download only if the selected code that currently resides in the monitor is an earlier version as compared to the software contained on the update diskettes.

---

---

### CAUTION

DO NOT update any of the boot code components unless absolutely necessary.

---

---

## Download Files to the Monitor

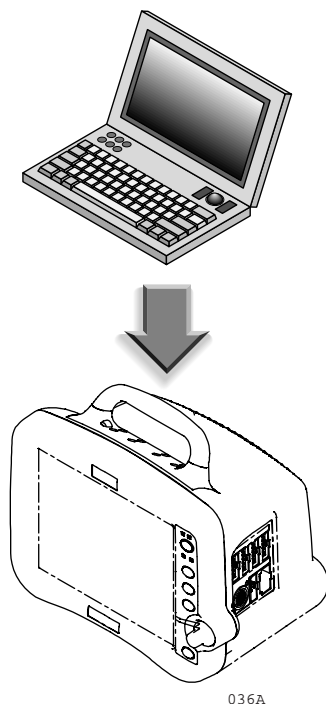

At this point, the monitor is ready to download files and the PC is set up to provide the files for download. Follow the next steps once the PC and monitor are set up for the download.

1. Moving back to the PC, find and select (highlight) the file requiring download from the UPDATE BEDSIDE utility menu list of files. If the list does not include the necessary file, eject the diskette from the floppy drive and insert the correct diskette. Press HOME on the PC keyboard to refresh the UPDATE BEDSIDE utility menu list.

Use the up/down arrow keys on the PC keyboard to scroll through the list of files contained on the update diskettes.

2. To begin the process of downloading the selected file, press ENTER on the PC keyboard.

---



---

### CAUTION

During the process of updating the software into the monitor, the update download program first erases all of the memory locations associated with each file. Problems in the download process may render the monitor useless.

**Do not** interrupt the download process once it has begun. If you encounter problems that render the monitor useless, contact the appropriate technical support group listed in the beginning of this manual.

---



---

The monitor indicates a warning if the file name from the PC does not match the file name residing in the monitor memory.

---



---

### CAUTION

**DO NOT** reboot or power down the monitor while you download boot code files. This renders the monitor useless and requires factory service.

---



---

## Verify PC-to-Monitor Communication

Messages appear on the monitor and PC displays indicating how the update is going. Verify the RECEIVED bytes advance. When the selected file has finished downloading, the monitor returns to the BOOT LOADER program and displays the SERVICE MENU, and the PC sounds an audible indication (a “beep”) and indicates a completed download process on the PC display. The monitor automatically restarts itself after any main processor code (MAIN SW REVISION or MAIN BOOT SW REVISION) is finished loading.

## Errors During Download Process

For most errors, simply press ENTER on the PC or repeat the download procedure. If the byte numbers stop advancing for more than two minutes. See “Problems While Loading Software” on page 6-6.

## Repeat Steps For Each File Requiring Update

Perform steps in “Setup Monitor To Accept Download Files” and “Download Files to the Monitor” for each file that requires an update before you proceed to the next steps.

# Load Software Over The Network

**About the Procedure** This section of the procedure provides instructions to load the contents of update diskettes 1, 2, and 3 to a Centralscope central station or Clinical Information Center (CIC) system hard disk drive, initiate the central station as a file server from the monitor, and download software to the monitor over the patient monitoring network.

**NOTE:** This method can only be used to update monitors connected to a patient monitoring network. If the monitor requiring update is not connected to the network or is connected to a network without central stations, you cannot use this procedure to update the monitor. See “Load Software From Diskette” on page 6-7 for an alternate procedure.

## Network Update Diskettes

Diskettes 1, 2, and 3 are used for this procedure and contain the control files for specifying which software component you need to download (listed in order by which these files must be downloaded to the monitor):

- Main processor operational code (MAIN.SCR) —this part of the update software includes monitor software in various languages, when available,
- DAS processor operational code (DASMAIN.SCR),
- Main processor boot code (BOOT.SCR), and
- DAS processor boot code (DASBOOT.SCR).

## Copy Files

The following steps describe how to copy files from update diskettes 1, 2, and 3 onto the Centralscope central station or CIC system hard disk drive. The Centralscope central station or CIC system acts as a file server for downloading update files to the monitor over the patient monitoring network.

1. Write down the Centralscope central station or CIC CARE UNIT NAME and CENTRAL NUMBER of that particular central station for use later in this procedure.
2. Insert diskette 1 from the Update Kit into the Centralscope central station or CIC floppy disk drive.
  - If you are downloading from a Centralscope central station, follow the instructions in the “Centralscope Central Station” section.
  - If you are downloading from a Clinical Information Center (CIC), follow the instructions in the “Clinical Information Center (CIC)” section.

## Centralscope Central Station

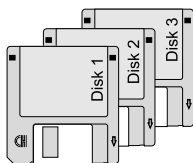

037A

1. At the Centralscope central station, execute the following menu sequence, starting from the Main Menu:

CENTRAL SETUP,  
SERVICE,  
PASSWORD (MEI CS 123),  
press ENTER,  
LOAD SOFTWARE (Wait 10 seconds), and  
FLOPPY.

2. Observe status messages in the upper left corner of the central station display. Verify the following messages:

LOADING FROM...FLOPPY, (then)  
LOADING DISK D3<version#> # 1 OF 3...

- NOTE:** The Centralscope central station may display status messages other than those described in these instructions. If, after 20 minutes, diskette 1 does not eject from the floppy drive, reboot the central station and start over.

3. When diskette 1 is completely loaded, the Centralscope central station automatically ejects the diskette and displays the message:

INSERT DISK D3<version#> #2 OF 3...

4. Follow the instructions on the screen to exchange diskettes in the disk drive as each one loads on the Centralscope central station hard drive.

5. When you finish loading diskette 3, the Centralscope central station automatically ejects the diskette and displays the message:

LOAD FROM FLOPPY COMPLETE.

## Clinical Information Center (CIC)

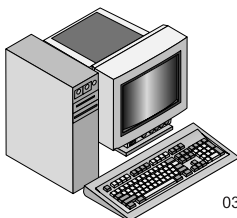
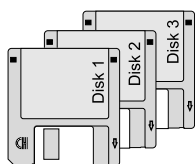

038A

1. At the Clinical Information Center, execute the following menu sequence, starting from the Main Menu:

SETUP CIC,  
then, select the SERVICE PASSWORD tab,  
Type password:mms\_com (lowercase with underscore)  
RETURN

2. At the C:\> prompt message, type:

A: cinstall xxx

Where xxx is the software version you are installing (such as V1A).

---



---

### NOTE

If you insert the wrong diskette, or type in the wrong version number, the screen displays an "Incorrect Disk" error message. Press CONTROL, C to restart the procedure.

---



---

3. Follow the instructions on the screen to exchange diskettes in the hard drive as each one loads on the Clinical Information Center hard drive.

4. When you finish loading the diskettes, the Clinical Information Center displays the message:  

INSTALL COMPLETE.
5. Click on the "X" in the upper right hand corner of each screen to close out the download screen and the main screen.

## Download Files to the Monitor

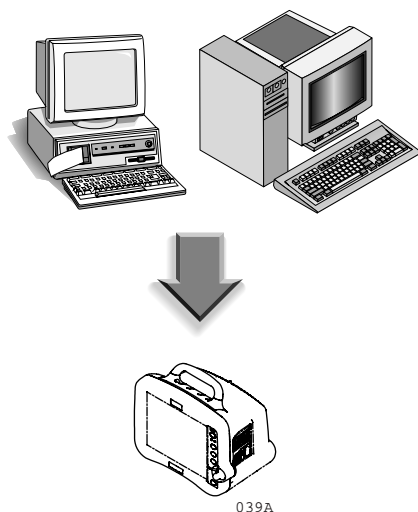

The following steps describe how to download files from the network to the monitor.

**NOTE:** Verify the monitor is on the network by selecting LIST NETWORK from the Service Monitor menu of the central station or CURRENT TELEMETRY LISTINGS from the SERVICE menu of the CIC system

1. At the monitor, start the BOOT LOADER program by following these steps:
  - Hold down the **NBP Go/Stop** and **Function** keys,
  - Press and release the Trim Knob control, and
  - Hold the **NBP Go/Stop** and **Function** keys until the BOOT LOADER menu appears on the monitor display.
2. Use the Trim Knob control to select the following at the FILE SERVER SELECTION menu:
  - In the menu list, identify and scroll to the central station which has the update files stored on it (this should have been noted or written down earlier in the procedure). This central station acts as a file server to download files to the monitor over the network.
  - Select the number corresponding to the central station that contains the update files.
3. Use the Trim Knob control to scroll to and select the number from the DIRECTORY SELECTION menu corresponding to:
 

/update.net/dash3000/<version#>
4. Compare the revision of the file to be updated with the software revision of the corresponding area of the monitor. Perform the following steps only if a file existing in the monitor is older than the update files just copied onto the central station hard drive.

5. From the SCRIPT NAME SELECTION menu list, use the Trim Knob control to scroll to and select the number corresponding to the file (script) requiring update. This list of files appears in the SCRIPT NAME SELECTION menu (listed in sequential order for each script to be loaded):

\*MAIN.SCR,  
\*BOOT.SCR,  
DASMAIN.SCR, and  
DASBOOT.SCR.

\*Monitor reboots after it loads these scripts.

Download only the files that require update based on a comparison of file revisions you made previously. Once you select a file, the monitor begins the download process.

6. The monitor should display the part number, version, and date of the file to be downloaded.

**NOTE:** A warning message and prompt appears on the monitor display. Use the Trim Knob control to scroll to and select YES if the file selected for download is correct.

---

---

#### CAUTION

DO NOT reboot or power down the monitor while you download the boot code components (BOOT.SCR, DASBOOT.SCR, etc.). This renders the monitor useless and manufacturer factory service is required.

---

---

7. The order in which the files are updated in the monitor is important. If an update of the main processor operational code (MAIN.SCR) or main processor boot code (BOOT.SCR) components is required, the monitor reboots automatically upon completion of each of those updates.
8. Messages appear on the display to indicate how the update is going.
9. For most errors, simply repeat the previous steps. If the byte numbers stop advancing for more than two minutes, start the procedure over or call technical support.
10. Perform the previous steps for each software file as required. This should be based on comparison of revisions made earlier in this procedure.
11. When the update is complete, use the Trim Knob control to scroll to and select the number corresponding to Start Patient Monitoring.



# Complete the Software Download

## Activate Software

1. Hold the NBP GO/STOP and the FUNCTION buttons and press the Trim Knob *at the same time*.
2. Release the Trim Knob and NBP GO/STOP and the FUNCTION buttons.

***If the screen remains blank***, the monitor is in “Standby Mode.” Press the POWER button to activate the monitor.

***If the screen brings up the display***, your monitor is okay.

3. Re-enter the monitor defaults that you wrote down or recorded at the beginning of this procedure. If you need any assistance, see the *Operator’s Manual*.

## Setup Graph Locations

To configure (set up) the proper graph locations for a monitor that has a stand-alone writer attached to it, connect the monitor to the network then follow these steps:

Use the Trim Knob control to scroll to and select the following menu options selection sequence. Starting from the Main Menu, scroll to and select:

MONITOR SETUP  
GRAPH SETUP  
GRAPH LOCATION

## Select a Writer

From the GRAPH LOCATION menu, use the Trim Knob control to scroll to and select:

- MANUAL GRAPH LOCATION (the monitor may take up to a minute to poll the network for available writers), then choose one of the manual graph locations from that list of writers;
- ALARM GRAPH LOCATION, then choose one of the alarm graph locations from that list of writers;
- PRINT WINDOW LOCATION, then choose one of the print window locations from that list of writers; and finally,
- 12 LEAD PRINT LOCATION, then choose one of the 12 lead print locations from that list of writers.

## Test the Monitor

Connect a patient simulator to the monitor. Admit the monitor and generate waveforms with the simulator powered up. Perform the following steps to test the communication paths between the monitor and each selected writer.

- Press the **Graph Go/Stop** key on the monitor front panel. Verify the graph output arrives at the selected manual graph location. Press the **Graph Go/Stop** key again to stop the manual graph.
- With the simulator generate a condition (i.e. ASYSTOLE) to cause a fatal alarm. Verify the graph output arrives at the selected alarm graph location.
- Display a non-real-time window on the monitor display. Print the window. Verify the print output arrives at the selected print window location.
- Run a 12-lead analysis if enabled. Verify the print output arrives at the selected 12 lead print location.

## Verify Software Update

Verify the software downloaded successfully. Starting from the Main Menu, scroll to and select:

*MORE MENUS*

*MONITOR SETUP*

*REVISION AND ID*

Press the **Graph Go/Stop** key

Compare the displayed monitor software revisions with those previously printed or written down. Repeat the entire procedure if software revisions are not properly updated.

## Update All Monitors

Load or update software for each monitor as required. Update software to current revisions in all monitors for best monitor performance and operation.

# Configuring a Monitor

This section explains how to configure a patient monitor. The procedure addresses use in both types of patient monitoring system configurations:

- **Stand-alone patient monitor:** The monitor is not interconnected to other patient monitoring system devices, and
- **Networked patient monitor:** The monitor is interconnected to other patient monitoring system devices for the sake of sharing patient data.

The following procedure explains how to configure a patient monitor on the Unity Network. The monitor communicates with central stations, and other related equipment over the Unity Network. This network is essentially an Ethernet implementation.

## General

Use this procedure if you are:

- experiencing communication problems on the Unity Network, or
- adding a new monitor to the Unity Network.

## Gather Information

To configure a new monitor, you must first:

- know that the new monitor's software revision is compatible with the other monitors connected to the Unity Network.
- write down the exact care unit name from the upper left hand corner of the central station.
- write down the bed name for the new monitor.
- know if the monitor will be used for either stationary or ambulatory (telemetry) monitoring or both.
- know if the monitor will be moved from one Ethernet connection to another.

## Select Procedures

Choose and program the procedures listed below in the order presented. Each procedure is described on the next pages.

### **Main Menu Selections**

- Set Unit Name
- Set Bed Number
- Patient-Monitor Type
- Set Graph Locations
- Admit Menu

### **Boot Code Selections**

- Defib Sync Voltage
- Defib Sync Pulse Width
- Line Frequency
- CIC Protocol
- QS Protocol
- MUSE Protocol
- Defib Sync Voltage and Pulse Width
- Set Country Selection
- Configure Wireless LAN

After completing all necessary procedures, perform the “Checkout Procedure” found in Chapter 4, Maintenance.

# Main Menu Selections

## Set Unit Name

Up to seven characters are used to identify the care unit. These characters display at the top right of the screen immediately preceding the bed number.

Access *SET UNIT NAME* option, starting from the Main Menu.

1. Select *MORE MENUS -> MONITOR SETUP -> SERVICE MODE*.
2. Enter password using the Trim Knob control to select the day and month from monitor screen with leading zeros. (e.g. July 4 = 0407)
3. Select *MONITOR SETTINGS -> UNIT NAME*.

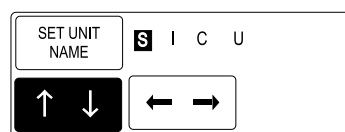

n4nA

4. Use the Trim Knob control to select and change each character. Up to seven characters may be entered.
5. Select *SET UNIT NAME* and press the Trim Knob control to exit.

## Set Bed Number

The bed number identifies a particular patient bed. Up to five characters are used to identify bed number. This number displays at the top right of the screen.

Access *SET BED NUMBER* option, starting from the Main Menu.

1. Select *MORE MENUS -> MONITOR SETUP -> SERVICE MODE*.
2. Enter password using the Trim Knob control to select the day and month from monitor screen with leading zeros. (e.g. July 4 = 0407)
3. Select *MONITOR SETTINGS -> UNIT NAME -> SET BED NUMBER*.

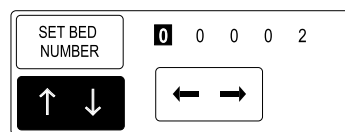

041A

4. Use the Trim Knob control to select and change each character. Up to five characters may be entered.
5. Select *SET BED NUMBER* and press the Trim Knob control to exit.

**Patient-Monitor Type** The *PATIENT-MONITOR TYPE* selection determines the type of monitor desired, i.e adult, neonatal or operating room. Different alarms and parameters are activated for each selection. This menu item is part of the *SERVICE MODE* menu.

---



---

**CAUTION**

Each time the patient-monitor type is changed, the *ADMIT MENU* function defaults to *STANDARD* configuration. Be aware that some alarms and parameters may be changed.

---



---

**NOTE:** The keypad/remote control is DIDCA programmed for specific monitor types. The error message *WARNING: REMOTE MISMATCHED WITH MONITORING MODE* displays if the monitor and keypad/remote control do not match.

Access *PATIENT-MONITOR TYPE* option, starting from the Main Menu.

1. Select *MORE MENUS -> MONITOR SETUP -> SERVICE MODE*.
2. Enter password using the Trim Knob control to select the day and month from monitor screen with leading zeros. (e.g. July 4 = 0407)
3. Select *PATIENT-MONITOR TYPE*. Be sure to read the information in the *ATTENTION* box before changing anything.

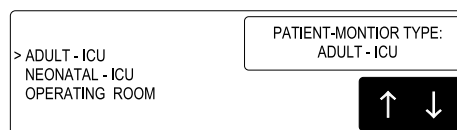

042A

4. Rotate Trim Knob control to select the type of environment the monitor will be used in.
5. Press Trim Knob control to exit. Your selection displays at the top of the screen after the time.

## Set Graph Locations

Access *MANUAL GRAPH LOCATION* option, starting from the Main Menu.

1. Select *MORE MENUS -> MONITOR SETUP -> GRAPH SETUP -> GRAPH LOCATION -> MANUAL GRAPH LOCATION*.
2. Using the Trim Knob control, choose the manual graph location from the list.
3. Select *ALARM GRAPH LOCATION*.
4. Using the Trim Knob control, choose the alarm graph location from the list.
5. Select *PRINT WINDOW LOCATION*.
6. Using the Trim Knob control, choose the print window location from the list.
7. Select *12 LEAD PRINT LOCATION*.
8. Using the Trim Knob control, choose the 12 lead print location from the list.

## Communication Confirmation

Confirm communication across the network.

1. Admit and generate a waveform at the monitor with a simulator.
2. Press **Graph Go/stop** and observe graph output at chosen locations.

## Problems?

If the writer or printer does not graph:

- Ensure the writer or printer is turned ON.
- Check all cables for a good connection.
- Check programmed alarms and manual graph locations at the monitor.

If you do not have a waveform at the central station:

- Ensure the central station software is compatible.
- Check all cables for a good connection.
- Check the programmed alarms and manual graph locations at the monitor.
- Ensure the care unit name is the same in the monitor and in the central station.
- Ensure the central station serial number and LAN address are programmed correctly.

## Admit Menu

The *ADMIT MENU* selection determines the function of the monitor. This menu item is part of the *SERVICE MODE* menu.

Before programming the *ADMIT MENU*, you must know if the monitor will be used for standard adult, neonatal, or operating room monitoring, and if the monitor will be moved from room to room. All combinations are explained below.

- STANDARD configures the monitor to stay in one room for stationary monitoring only. Monitors not connected to the Unity Network (Ethernet connection) must use STANDARD configuration only.
  - ROVER configures the monitor to move from room to room for stationary monitoring only.
  - COMBO configures the monitor to stay in one room for both stationary and ambulatory (telemetry) monitoring. This monitor displays all Tram module data combined with ECG data for ambulatory patients.
  - ROVER COMBO configures the monitor to move from room to room for both stationary and ambulatory (telemetry) monitoring.
1. Access *ADMIT MENU* option, starting from the Main Menu. Select *MORE MENUS* -> *MONITOR SETUP* -> *SERVICE MODE*.
  2. Enter password using the Trim Knob control to select the day and month from monitor screen with leading zeros. (e.g. July 4 = 0407)
  3. Select *MENU SETUP* -> *ADMIT MENU*.

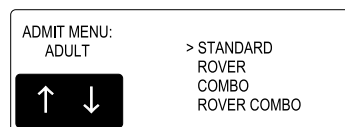

4. Use the Trim Knob control to select the function of the monitor.
5. Press Trim Knob control to exit.



## Boot Code Selections

### Set Defib Sync Voltage and Pulse Width

The monitor controls the analog out signal used to trigger a defibrillator. Refer to the defibrillator manufacturer's manual for the required pulse amplitude and duration.

Use the Boot Code *SERVICE MENU* to configure or change the MARKER OUT signal of the DEFIB SYNC connector.

Activate the Boot Code:

1. Hold down **NBP Go/Stop** and **Function**.
2. Press and release the Trim Knob control.
3. Keep holding **NBP Go/Stop** and **Function** until the Boot Code information appears on the display.
4. Select *SERVICE MENU*.
5. Select *SET CONFIGURATION* menu option.
6. In the *Configuration Menu*, select:
  - ◆ *1 Defib Sync Voltage:* and choose 5V or 12V amplitude.
  - ◆ *2 Defib Sync Pulse Width:* and choose 10 ms or 100 ms for pulse duration.

### Set Line Frequency

Use the Boot Code *SERVICE MENU* to configure or change the monitor line frequency to 50 or 60 Hz. The default is 60 Hz.

Activate the Boot Code:

1. Hold down **NBP Go/Stop** and **Function**.
2. Press and release the Trim Knob control.
3. Keep holding **NBP Go/Stop** and **Function** until the Boot Code information appears on the display.
4. Select *SERVICE MENU*.
5. Select *SET CONFIGURATION* menu option.
6. Select *Line Frequency* then choose 50 Hz or 60 Hz line frequency.

### Set CIC and QS Protocol

The CIC and QS Protocol default setting is *Seg50/51* (Segment 50/51) and should not be changed. However, future products may require Hilltop protocol. Use the Boot Code *SERVICE MENU* to change the *CIC Protocol* and *QS Protocol*.

## Set MUSE Protocol

The monitor transmits 12SL and ACI-TIPI data over the Unity Network to the MUSE and ST Guard. The formats used for this process are Hilltop and Segment 50/51. Since the Segment 50/51 format does not support 500 Hz ECG data or ACI-TIPI, records originally stored on the MUSE in Hilltop format cannot be displayed at the ST Guard.

Use the Boot Code *SERVICE MENU* to set the MUSE Protocol. The default setting is Hilltop.

Activate the Boot Code:

1. Hold down **NBP Go/Stop** and **Function**.
2. Press and release the Trim Knob control.
3. Keep holding **NBP Go/Stop** and **Function** until the Boot Code information appears on the display.
4. Select *SERVICE MENU*.
5. Select *SET CONFIGURATION* menu option.
6. Select *MUSE Protocol* then choose *Hilltop* or *Seg50/51*.
  - **Hilltop**—Sends 12SL records to the MUSE in Hilltop format. The ST Guard will not be able to retrieve 12SL records stored on the MUSE, but the 12SL records will contain 500 samples per second of ECG data.
  - **Seg50/51**—Sends 12SL records to the MUSE in Segment 50/51 format with MAC Rhythm statements. The 12SL records stored on the MUSE will be in the existing 240 samples per second format and ST Guard will be able to retrieve them from the MUSE. ACI-TIPI data will not be available at the MUSE if this protocol is selected.

## Transcutaneous Pace Blank Length

This menu option is reserved for future use and should not be changed.

## Set Country Selection

Select *DEFAULT* or *FRANCE* to choose a particular set of GE Medical Systems *Information Technologies*' factory defaults.

Activate the Boot Code:

1. Hold down **NBP Go/Stop** and **Function**.
2. Press and release the Trim Knob control.
3. Keep holding **NBP Go/Stop** and **Function** until the Boot Code information appears on the display.
4. Select *SERVICE MENU*.
5. Select *SET CONFIGURATION* menu option.
6. In the *Configuration Menu*, select *Country Selection* and choose language.

## Wireless LAN

Confirm the configuration of the optional Wireless LAN.

Activate the Boot Code:

1. Hold down **NBP Go/Stop** and **Function**.
2. Press and release the Trim Knob control.
3. Keep holding **NBP Go/Stop** and **Function** until the Boot Code information appears on the display.
4. Select *SERVICE MENU*.
5. Select *SET CONFIGURATION* menu option.
6. In the *Configuration Menu*, select *Configure Wireless LAN to Change SSIDs and Enable/Disable Wireless LAN*.

**NOTE:** Do not change the SSID. Enable the Wireless LAN option if the monitor has been upgraded to with Wireless LAN.

## Completion

The monitor is now ready for normal operation. At this time, perform the "Checkout Procedure" found in Chapter 4, Maintenance.

# Advanced User Procedures

The following procedures are for advanced users only. These procedures should rarely be used, and only experienced technicians should proceed.

## Procedures

The following procedures are discussed later in this chapter.

- Set Time and Date
- Change Software Level
- Change Ethernet Address
- Set Internet Address
- Reviewing Error Logs
- Transferring Error Logs
- Reviewing Event Logs

After completing any of the procedures, it is recommended to perform the “Checkout Procedure” found in Chapter 3, Maintenance.

## Set Time and Date

Change the time only when the system is switched to or from daylight savings time.

**NOTE:** When a monitor is first connected to the Unity Network, the time and date is automatically updated from the network time.

---

---

### WARNING

Loss of patient data history. Changing the time or date settings may result in the loss of patient data history. If one monitor’s time or date is changed, all monitors on the network ‘listen’ and follow suit within 3-5 seconds. Changing the time base of one monitor may cause some loss of patient data history for all the monitors on the network.

---

---

The following procedure explains how to use the *TIME AND DATE* option in the monitor *SERVICE MODE* menu.

1. Access the *TIME AND DATE* menu starting from the Main Menu. Select *MORE MENUS* -> *MONITOR SETUP* -> *SERVICE MODE*.
2. Enter password using the Trim Knob control to select the day and month from monitor screen with leading zeros. (e.g. July 4 = 0407)
3. Select *SET TIME* and use the Trim Knob control to change the time. The time displays as a 24-hour military clock.
4. Select *SET DATE* and use the Trim Knob control to change the date.

## Change Software Level

### Lower Level

The highest software feature level (7015, 7020, 7025) of the patient monitor is programmed into the serial EEPROM of the processor PCB. You may only change the feature level to a lower level than the level programmed at the factory through the Main Code.

1. Access the *SOFTWARE LEVEL* option starting from the Main Menu. Select *MORE MENUS -> MONITOR SETUP -> SERVICE MODE*.
2. Enter password using the Trim Knob control to select the day and month from monitor screen with leading zeros. (e.g. July 4 = 0407)
3. Select *MENU SETUP -> SOFTWARE LEVEL*.
4. Use the Trim Knob control to select the software level.
5. Press the Trim Knob control to exit. Your selection displays at the top of the screen following the time.

### Higher Level

If you want to change the software to a higher level, it must be done in Boot Code using a unique password.

Fax a password request to GE Medical Systems *Information Technologies*' Software Upgrade Coordinator at (414) 362-3250 to obtain a password. You must provide your product serial number and Ethernet address. (The Ethernet address displays in the Boot Code banner information.)

Activate the Boot Code program as follows:

1. Hold down **NBP Go/Stop** and **Function** on the front panel.
2. Press and release the Trim Knob control.
3. Keep holding **NBP Go/Stop** and **Function** until the Boot Code information appears on the display.
4. Select *Service Menu -> Option Menu -> Change Software Level*.

## Change Ethernet Address

The Ethernet address is an identification number assigned to each device on the Unity Network. It must be done in Boot Code using a unique password only if it has been corrupted. Contact your sales/service representative and provide them with the serial number and Ethernet address of the unit to obtain a password.

---

---

### WARNING

Lost Data. Duplication of an Ethernet address on a network will cause lost data. If you change the factory assigned Ethernet address, you must first record all *other* Ethernet addresses used on your network to avoid duplication.

---

---

Activate the Boot Code program as follows:

1. Hold down **NBP Go/Stop** and **Function** on the front panel.
2. Press and release the Trim Knob control.
3. Keep holding **NBP Go/Stop** and **Function** until the Boot Code information appears on the display.
4. Select *Service Menu -> Option Menu -> Change Ethernet Address*.

## Review Errors

This procedure describes how to review the error logs of a monitor. The error logs may also be transferred over the network to a central station and copied onto diskette for further review or sent to GE Medical Systems *Information Technologies*' personnel for review. The transferring procedure "Copying Error Log Files" is described later in this chapter.

---

---

### WARNING

This procedure is intended for use by service personnel with advanced troubleshooting skills.

---

---

Some of the information recorded in the error logs is useful for field troubleshooting. The details included here serve as an introduction to the error logs and provide basic information about what you can learn from them.

1. Access *REVIEW ERRORS* starting from the Main Menu. Select *MORE MENUS -> MONITOR SETUP -> SERVICE MODE*.
2. Enter password using the Trim Knob control to select the day and month from monitor screen with leading zeros. (e.g. July 4 = 0407)
3. Select *REVIEW ERRORS*.

The menu provides four error log choices, two for viewing error logs and two for clearing the error logs.

## View Output/Input Errors

1. Select *VIEW OUTPUT ERRORS* or *VIEW OUTPUT ERRORS* to view one error in the log of errors.

The error log in a monitor holds 50 errors that can be accessed with the *NEXT* or *PREVIOUS* command. The errors display one error at a time in the upper right corner of the screen. Watch the error number category to keep track of which error you are viewing.

The *VIEW OUTPUT ERRORS* provides a list of output software errors; the *VIEW INPUT ERRORS* provides a list of input software errors.

2. To clear all the errors in the error log, select *CLEAR OUTPUT ERRORS* or *CLEAR INPUT ERRORS* menu option. Be aware that once the clear menu option is executed, all selected errors in memory are erased.

## Useful Error Data

Below is sample error log followed by a description of parameters found in the error log.

RUN TIME ERROR LOG	
Status Register:	9032
Program Counter:	40002484
User Stack Pointer:	187158
Super Stack Pointer:	37FFE8
Heap Pointer:	1D5DF0
Process Name:	start
Error Code:	1BC0
Severity:	Continue
Date:	JUL 27 2000
Time:	15: 54 :19
Error Number:	8
422229-002 VER 2A 14JUN00	

049A

### Process Name

The name of the software task that was operating when the event/problem occurred.

## Error Code

The error log contains more than just operating system errors. Many events that have an impact upon the system are also entered into the log. The 700-series of error codes are really system initiated events. Listed below are some of the event/error codes you might find useful.

Definition of Error Codes	
Error Code	Description
400-4FF	Network errors were detected.
703	Diagnostic tests were completed.
70B	Internet address was changed. The network address for the monitor was changed. This should only be done by qualified service personnel.
70C	Video test was completed. This test should only be performed by qualified service personnel.
70E	Time was changed from this monitor. This helps determine how the system-wide time may have been altered.
70F	Date was changed from this monitor. This helps determine how the system-wide date was altered.
710	Incompatible software was detected. If the main processor software finds that the software operating on the communication software incompatible, it turns off the communication (network) controller and enters this data into the error log. When the monitor won't "talk" to the network, looking for this entry in the error log is one part of the troubleshooting process.

**NOTE:** The monitor may be referred to as a display or scope in the error code descriptions.



## **Severity**

Severity is a measure of how the event/error affected the system. There are three levels of severity.

*CONTINUE*—the event/error was logged, the task may have or may not have been finished, but the system was able to go on. Most log entries will have a severity of *CONTINUE*.

*FATAL*—the event/error was such that the task is not able to go on. Recovery was not possible. This always is followed by a WARM START.

*FORCED RESTART*—the system was restarted by a known condition (internet address change, video test, etc).

## **Date and Time**

The date and time the event/problem occurred.

## **Error Number**

A sequential number that is used to identify each event/problem.

# Transferring Error Logs

## General

The following procedure describes how to copy the patient monitor and parameter module error logs and then transfer them to a diskette at the Centralscope central station. To transfer error files from a Clinical Information Center (CIC), refer to the GE Medical Systems *Information Technologies*' Prism Information Field Service Manual.

A Centralscope or CIC central station can perform normal patient data display tasks and act as a remote terminal. The remote terminal function is useful for retrieving, viewing, and saving error logs from any GE Medical Systems *Information Technologies*' patient monitoring equipment communicating on the Unity Network. Through a series of menus, a device such as a monitor, another central station, or parameter module, can be selected in any Care Unit. Then a device error log for a particular day may be chosen.

Once the desired error log is selected it can be copied over the network to a floppy diskette in the central station's floppy diskette drive. Since the error logs are text files they can be read into other computers and using most text editors or word processing applications.

Use the following procedure to transfer error files from a Centralscope central station.

---

---

### CAUTION

This procedure is intended for use by service personnel with advanced troubleshooting skills. Do not "experiment" with these commands! The consequences of misuse include loss of patient data, corruption of the central station operating software, or disruption of the entire Unity Network.

---

---

## Access the *COPY LOGS* Menu

1. Beginning with the CentralScope central station Main Menu select *CENTRAL SETUP* -> *SERVICE*.
2. Enter password: **MEI CS 123**
3. Select *COPY LOGS*. The *COPY LOGS* menu displays.

PREVIOUS MENU	UNIT: CCU	DEVICE: BED-2				START COPY

048A

## Select the Care Unit

1. Select *UNIT*:
2. Using the Trim Knob control, change the displayed Care Unit name. When the desired Care Unit name displays, press the Trim Knob control.

PREVIOUS MENU	UNIT: CCU	ICU				START COPY
	↑ ↓					

044A

## Select the Monitoring Device

1. Select *DEVICE*:
2. Using the Trim Knob control, change the displayed device name. Note that only monitoring devices within the previously selected Care Unit show. When the desired monitoring device name displays, press the Trim Knob control.

PREVIOUS MENU	UNIT: CCU	DEVICE: BED-2				START COPY
		↑ ↓	BED-4			

045A

## Select the Error Log Date

1. Select *DATE*:
2. Using the Trim Knob control, change the error log date. Note that one of the selections is *ALL*, which retrieves all stored error logs from the specified device. When the desired date displays, press the Trim Knob control.

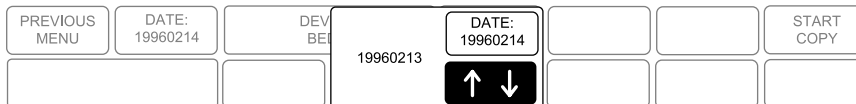

046A

## Copy Error Logs

Once the Care Unit, device, and date have been specified the final step is to begin copying the error logs to the floppy diskette.

1. Insert a PC-formatted, high-density floppy diskette into the floppy diskette drive of the central station.
2. Select *START COPY*. A new display appears that confirms the file source device.

Using the Trim Knob control, select the desired function. Press the Trim Knob control to start.



047A

Once the copy function begins the *START COPY* button changes to show the function: “copying.”

## Eject Floppy

Select this option to eject the floppy diskette from the central station’s disk drive.

*For your notes*



# 7 CALIBRATION

CALIBRATION:

---

*For your notes*



# Hardware Calibration

There are NO FIELD ADJUSTMENTS or calibration for the following hardware components:

- Processor PCB
- DAS PCB
- Power Supply PCB
- Display - color
- Writer Assembly

These adjustments are set and sealed during manufacture of the component or assembly. Breaking the seal of the adjustments voids the calibration.

# NBP, ECG, BP, and End-tidal CO<sub>2</sub> Software Calibration

Noninvasive blood pressure (NBP), ECG, Invasive Pressures (BP), and End-tidal CO<sub>2</sub> (optional) require software calibration.

Perform the NBP, ECG, BP, and End-tidal CO<sub>2</sub> software calibration upon receipt of the equipment, every 12 months thereafter, and each time the unit is opened for service. This ensures the pneumatic circuit plumbing has not developed any air leaks as a result of disassembly.

## NBP Calibration

### In General

The overall accuracy of noninvasive blood pressure (NBP) readings by the monitor depend on the following:

- the zero pressure reading, and
- the voltage span of the NBP sensor in the monitor.

This procedure provides a method of verifying these items are accurate and also checks the NBP pneumatic circuit plumbing for leaks.

The manufacturer recommends performing this procedure upon initially receiving the monitor, before it is used on a patient, and once each year thereafter. Also, perform the procedure each time the monitor is opened for service or repair, simply to verify the NBP pneumatic circuit plumbing did not develop inadvertent air leaks.

### Required Test Equipment

The following items are required to successfully complete the NBP calibration procedure. See “Noninvasive Blood Pressure Tests” on page 4-38 for setup guidelines.

- Voltmeter,
- Unterminated defib sync cable,
- Manometer (Sensym PDM200M or mercury manometer),
- NBP tube, pn 9461-203,
- NBP cuff, pn 9461-301 (any size works), and
- Something to wrap the NBP cuff around (PVC pipe or coffee can).

The table below lists items for connecting the NBP tube between the manometer and NBP cuff:

<b>Description</b>	<b>Part Number</b>	<b>Qty</b>
NBP cuff coupling	400787-001	1
NBP hose coupling	46100-002	1
NBP tee	4745-101	1
NBP tubing	401582-001	2

---



---

**WARNING**

When the NBP cuff is used in this procedure, it must be tightly wrapped around a rigid cylinder or pipe. **DO NOT** put the NBP cuff around a human arm during the calibration procedures due to the potential for injury.

---



---

## Calibration Procedure

Using the Trim Knob control, access the *SERVICE MODE* menu starting from the MAIN menu.

1. Select *MORE MENUS-> MONITOR SETUP-> SERVICE MODE*.
2. Enter password using the Trim Knob control to select the day and month from monitor screen with leading zeros. (e.g. July 4 = 0407).
3. Select *CALIBRATE-> CALIBRATE NBP-> CAL ZERO OFF-> START*.
4. The text on the menu item changes from *CAL ZERO OFF* to *CAL ZERO IN PROGRESS*.

When the process is complete, the menu item shows that it is *OFF* again.

To proceed with the Gain Calibration Test, setup the monitor and test equipment following the guidelines illustrated in the NBP Checkout Procedure, Chapter 4, Maintenance.

## Gain Calibration Test

1. Connect a cuff and manometer to the monitor.
2. Turn the digital manometer on and adjust the range switch to 1000 mmHg.
3. Select *CAL GAIN OFF*-> *CAL GAIN OFF*-> *START*.
4. The second line of text on the CAL GAIN menu item changes from *CAL GAIN HOLDING* to *CAL GAIN INFLATING*. The monitor starts pumping up the pressure bulb or cuff—the audible whirring sound of the NBP pump motors occurs and an increase in displayed pressures on both the monitor and the manometer can be observed.
5. The pump shuts off at about 250 mmHg, and the pressure drops slowly to about 240 mmHg before stabilizing. The second line of text on the *CAL GAIN* menu item changes from *INFLATING* back to *HOLDING*. If the pressure continues to drop at a rate of 1 mmHg or more for every five seconds, there is a leak in the NBP plumbing. If there is a leak in the NBP plumbing, repair it and restart this calibration procedure.
6. Select *ENTER CAL PRESSURE* and use the Trim Knob control to select a pressure value that is 1 mmHg lower than the current manometer reading. When the manometer falls to exactly the value that you selected in the pop-up window, press the Trim Knob control to enter the value.
7. Select *CHECK CAL OFF*-> *START*.
8. The text on the menu item changes from *CHECK CAL OFF* to *CHECK CAL IN PROGRESS*. Verify the pressure readings (shown as CUFF in the NBP parameter box) on the monitor and manometer are equal ( $\pm 1$  mmHg) for *at least* one full minute.

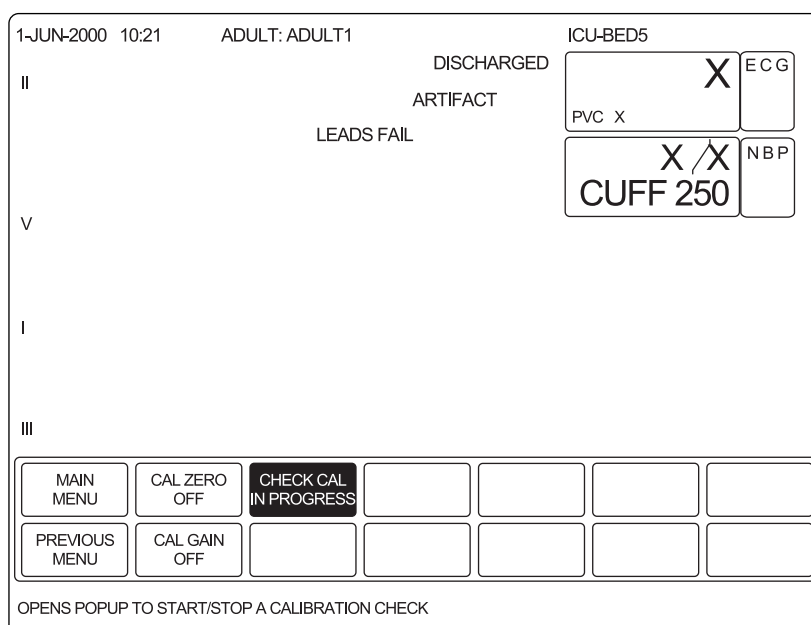

028B

9. Select *CHECK CAL IN PROGRESS* -> *STOP*. The monitor automatically releases pneumatic pressure in the entire plumbing circuit.

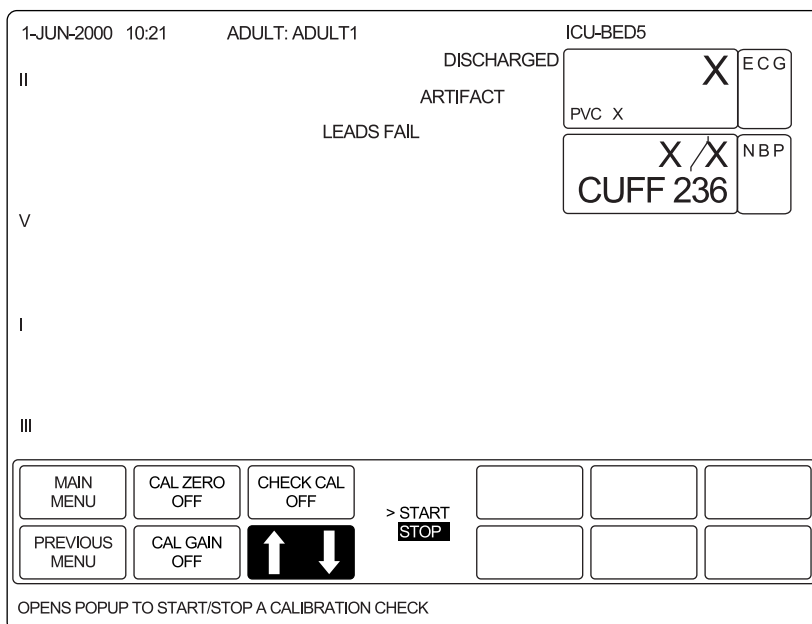

029A

10. Unplug the monitor from AC power source and remove the test apparatus from the monitor.

## ECG or BP Calibration

### Before you Begin

To complete the ECG or BP calibration, you must connect a voltmeter to the monitor.

1. Attach the analog output cable (pn 2000633-001) to the monitor.
2. Connect a precision voltmeter (such as HP34401A, or equivalent) to the port pin to be calibrated (ECG pin 7, BP pin 6, and GRND pin 3 or pin 4).



022A

3. Access the monitor's Service Mode
4. Calibrate the ECG or the BP parameters.

### ECG Calibration

Using the Trim Knob control, access the *SERVICE MODE* menu starting from the *MAIN* menu.

1. Select *MORE MENUS*-> *MONITOR SETUP*-> *SERVICE MODE*.
2. Enter password using the Trim Knob control to select the day and

month from monitor screen with leading zeros. (e.g. July 4 = 0407).

3. Select *CALIBRATE-> CAL ECG ANALOG OUT-> SET ECG LOW*.

Adjust the count for -9.0 volts on the meter and press the Trim Knob control.

4. Select *SET ECG HIGH*.

Adjust the count for -9.0 volts on the meter and press the Trim Knob control.

5. Select *SET ECG ZERO*.

Adjust the count for 0.0 volts on the meter and press the Trim Knob control.

6. Select *CONFIRM ECG CAL* to confirm or abort the calibration

## BP Calibration

Using the Trim Knob control, access the *SERVICE MODE* menu starting from the *MAIN* menu.

1. Select *MORE MENUS-> MONITOR SETUP-> SERVICE MODE*.

2. Enter password using the Trim Knob control to select the day and month from monitor screen with leading zeros. (e.g. July 4 = 0407).

3. Select *CALIBRATE-> CAL BP ANALOG OUT-> SET BP LOW*.

Adjust the count for -9.0 volts on the meter and press the Trim Knob control.

4. Select *SET BP HIGH*.

Adjust the count for -9.0 volts on the meter and press the Trim Knob control.

5. Select *SET BP ZERO*.

Adjust the count for 0.0 volts on the meter and press the Trim Knob control.

6. Select *CONFIRM BP CAL* to confirm or abort the calibration

## End-tidal CO2 Calibration

To calibrate the End-tidal CO2, see the CO2 chapter in the monitor's operator manual.

# 8 FIELD REPLACEABLE UNITS AND UPGRADES

**NOTE:** Field replaceable units (FRU's) are available for some assemblies. See Chapter 9, Assembly Drawings, for part numbers.

*For your notes*



# Disassembly Guidelines

## Tools Required

A standard set of hand tools is required for disassembly and assembly.

## Before Disassembly

Before you disassemble the monitor, you should ALWAYS:

- Remove AC power.
- Remove both batteries.
- Provide appropriate electrostatic discharge protection to prevent damaging the monitor.
- Be aware that the nonspecific disassembly instructions apply to all Dash monitors supported by this service manual. Disassembly for specific models of the Dash monitor are identified when required.

## Hardware Assemblies

When disassembling the monitor, observe the following guidelines:

- Remove the handle assembly, then remove the display assembly to access the field replaceable or upgradeable components of the display assembly and the main unit.
- Note the positions of wires, cables, and different sized screws; marking them if necessary to ensure they are replaced correctly.
- Save and set aside all hardware for re-assembly.

## PCB Assemblies

### Electrostatic Discharge (ESD) Precautions

All external connector inputs and outputs of the monitor are designed with protection from ESD damage. However, if the monitor requires service, exposed components and assemblies contained within are susceptible to ESD damage. This includes human hands, non-ESD protected work stations and/or improperly grounded test equipment.

The following guidelines help make a service workstation more resistant to the ESD damage:

- Discharge any static charge you may have built up before handling semiconductors or assemblies containing semiconductors.
- A grounded, antistatic wristband (3M part number 2046 or equivalent) or heel strap should be worn *at all times* while handling or repairing assemblies containing semiconductors.
- Use properly grounded soldering and test equipment.
- Use a static-free work surface (3M part number 8210 or equivalent) while handling or working on assemblies containing semiconductors.
- DO NOT remove semiconductors or assemblies containing semiconductors from antistatic containers (Velo-stat bags) until absolutely necessary.
- Make sure power to an assembly is turned off before removing or inserting a semiconductor.

- DO NOT slide semiconductors or electrical/electronic assemblies across any surface.
- DO NOT touch semiconductor leads unless absolutely necessary.
- Semiconductors and electrical/electronic assemblies should be stored only in antistatic bags or boxes.
- Handle all PCB assemblies by their edges.

These guidelines may not guaranty a 100% static-free workstation, but can greatly reduce the potential for failure of any electrical/electronic assemblies being serviced.

## After Reassembly

After reassembling the monitor, ALWAYS complete the calibration tests, checkout procedures, electrical safety tests, and regular maintenance procedures identified and described in this manual.

Recommended Calibration, Electrical Safety Tests, and Checkout Procedures			
Replacement or Upgrade Procedure	Calibration Tests	Checkout Procedures	Electrical Safety Tests
Alarm Light Option Backlight Inverter PCB	None	<ul style="list-style-type: none"> <li>“Monitor Power-up Tests” on page 4-26.</li> <li>“Display Test” on page 4-44.</li> <li>“5 Lead ECG Test” on page 4-27. Complete Steps “1.” through “4.”</li> </ul>	<ul style="list-style-type: none"> <li>“Wall Receptacle Test” on page 4-11.</li> <li>“Ground (Earth) Integrity” on page 4-11.</li> <li>“Ground (Earth) Wire Leakage Current Tests” on page 4-13.</li> <li>“Enclosure Leakage Current Test” on page 4-15.</li> <li>“Patient (Source) Leakage Current Test” on page 4-17.</li> <li>“Patient (Sink) Leakage Current Test (Mains Voltage on the Applied Part)” on page 4-19.</li> </ul>
Speaker	None	Complete ALL the Checkout Procedures identified in Chapter 4, Maintenance.	
Keypad Assembly LCD Color Display	None	<ul style="list-style-type: none"> <li>“Monitor Power-up Tests” on page 4-26.</li> <li>“Display Test” on page 4-44.</li> </ul>	
DAS Assembly	NBP on page 7-4.	<ul style="list-style-type: none"> <li>“ECG Tests” on page 4-27.</li> <li>“Respiration Tests” on page 4-30.</li> <li>“Temperature Tests” on page 4-31.</li> <li>“Cardiac Output Tests” on page 4-32.</li> <li>“Invasive Blood Pressure Tests” on page 4-34.</li> <li>“Pulse Oximetry Tests” on page 4-36.</li> <li>“Noninvasive Blood Pressure Tests” on page 4-38.</li> <li>See the CO2 chapter in the monitor’s operator manual to checkout the End-tidal CO2.</li> </ul>	
NBP Assembly	NBP on page 7-4.	<ul style="list-style-type: none"> <li>“Noninvasive Blood Pressure Tests” on page 4-38.</li> </ul>	

<b>Recommended Calibration, Electrical Safety Tests, and Checkout Procedures</b>			
<b>Replacement or Upgrade Procedure</b>	<b>Calibration Tests</b>	<b>Checkout Procedures</b>	<b>Electrical Safety Tests</b>
RF LAN Option	None	<ul style="list-style-type: none"> <li>• “Monitor Power-up Tests” on page 4-26.</li> <li>• “Network Test” on page 4-44.</li> <li>• “RF LAN Test (option)” on page 4-44.</li> </ul>	<ul style="list-style-type: none"> <li>• “Wall Receptacle Test” on page 4-11.</li> <li>• “Ground (Earth) Integrity” on page 4-11.</li> <li>• “Ground (Earth) Wire Leakage Current Tests” on page 4-13.</li> </ul>
Power Supply Assembly	None	<ul style="list-style-type: none"> <li>• “Monitor Power-up Tests” on page 4-26.</li> <li>• “Battery Tests” on page 4-43.</li> </ul>	<ul style="list-style-type: none"> <li>• “Enclosure Leakage Current Test” on page 4-15.</li> <li>• “Patient (Source) Leakage Current Test” on page 4-17.</li> </ul>
Processor/Power Management	ECG and BP on page 7-7.	<ul style="list-style-type: none"> <li>• “Monitor Power-up Tests” on page 4-26.</li> <li>• “Analog Output and Defibrillator Synchronization Tests” on page 4-40.</li> <li>• “Battery Tests” on page 4-43.</li> <li>• “Graph Test” on page 4-43.</li> <li>• “Graph Speed Test” on page 4-43.</li> <li>• “Display Test” on page 4-44.</li> <li>• “Speaker Test” on page 4-44.</li> <li>• “Network Test” on page 4-44.</li> <li>• “RF LAN Test (option)” on page 4-44.</li> <li>• “RAC 2A Module Housing Test” on page 4-45.</li> </ul>	<ul style="list-style-type: none"> <li>• “Patient (Sink) Leakage Current Test (Mains Voltage on the Applied Part)” on page 4-19.</li> </ul>
Writer (Recorder)	None	<ul style="list-style-type: none"> <li>• “Monitor Power-up Tests” on page 4-26.</li> <li>• “Graph Test” on page 4-43.</li> <li>• “Graph Speed Test” on page 4-43.</li> </ul>	

## Handle Assembly

---

---

**NOTE**

The alarm light is an option and may not be on your monitor.

---

---

### Removing the Handle Assembly

- Remove the two screws holding the handle to the monitor. Take care not to strain the cables if your monitor has the optional alarm light.



## Replacing or Upgrading the Dash 3000 Alarm Light Option

1. Remove the two screws holding the handle together.



2. Complete the following steps identified for your service procedure.

Alarm Light Replacement	Alarm Light Upgrade (FRU)
a. Remove the clear plastic cover.	a. Remove the blank plastic cover.
b. Disconnect the Alarm Light cable harness from the Alarm Light PCB.	b. Insert the Alarm Light PCB.
c. Replace the defective Alarm Light PCB.	

3. Connect the Alarm Light cable harness to the Alarm Light PCB and route the cables as shown.

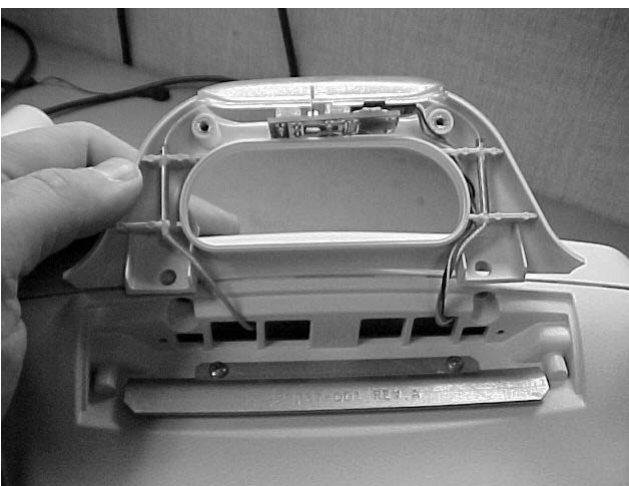

4. Replace the clear plastic cover and reassemble the handle.

## Display Assembly Components

### Removing the Display Assembly from the Main Unit

This procedure allows you to access the field replaceable or upgradeable components of the monitor's display assembly and the main unit.

1. Remove the handle assembly from the monitor. See "Removing the Handle Assembly" on page 8-7.
2. Place the monitor face down on a non-abrasive, static-free surface. Make sure the Trim Knob control hangs off the edge of the surface to avoid damage.
3. Remove the four screws to separate the display assembly from the main unit.

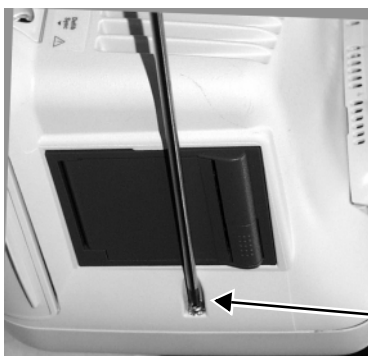

One screw on the left side of the unit...

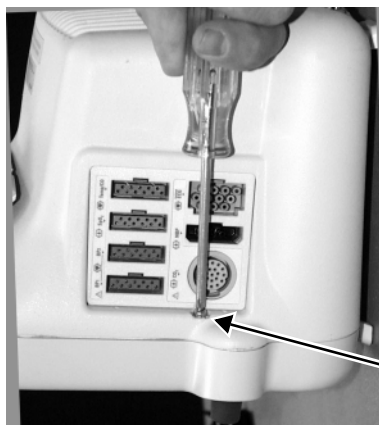

one screw on the right side of the unit...

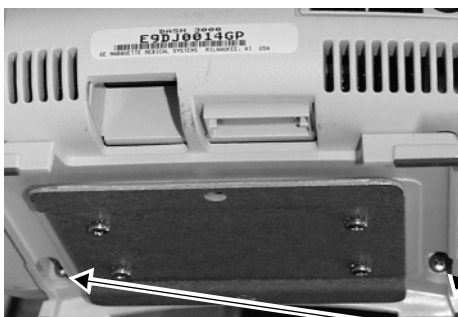

...and two screws on the bottom of the unit.

4. Remove the two screws attaching the flex circuit to the main unit's processor/power management PCB. Remove the flex connector by pulling on the flex connector strain relief.

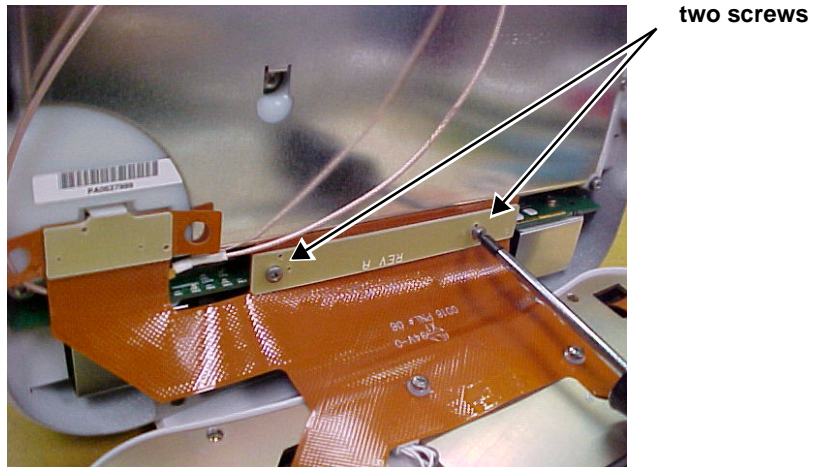

5. Remove the DAS connector by lifting the snap latch and tabs.

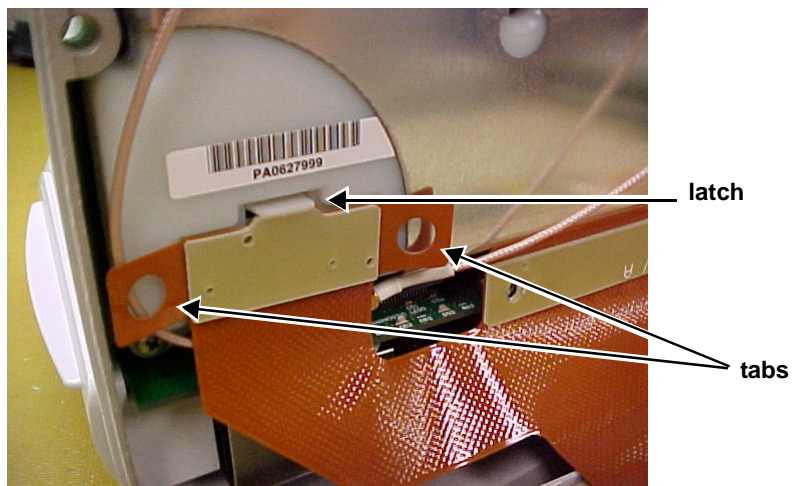

6. Place the display assembly face down on a non-static, non-abrasive surface. Make sure the Trim Knob control hangs off the edge of the surface to avoid damage

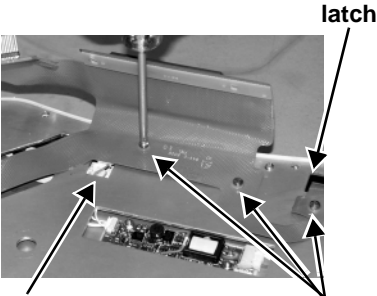
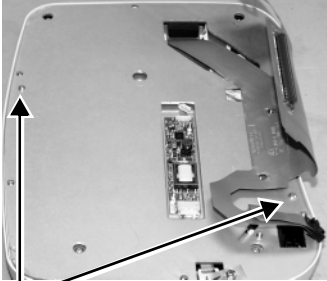
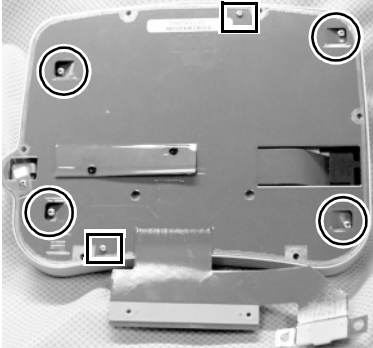
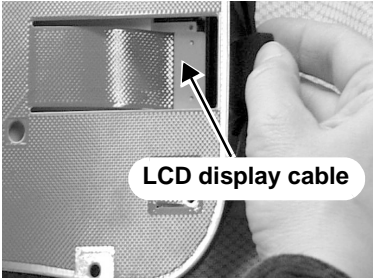
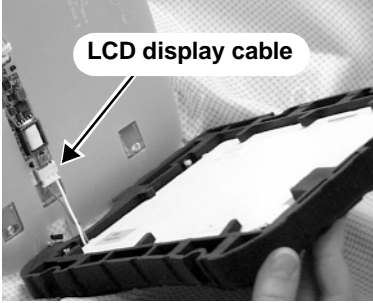
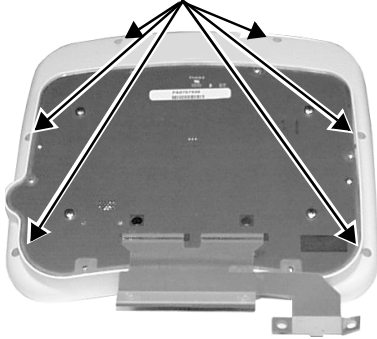
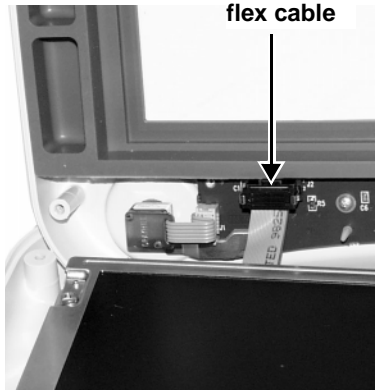

7. Complete the following steps for the monitor you are servicing.

<p><b>Dash 3000 with color display flex circuit</b></p>	<p><b>Dash 3000 with display shield flex circuit</b></p>	<p><b>Dash 4000</b></p>
<p>Remove the flex circuit and the display brackets.</p> <p>a. Remove the three screws and nylon washers holding the flex circuit to the back of the display bracket. Use a flat-head screw driver to unlock the latch and disconnect the flex circuit from the key pad assembly. Disconnect the cable harness from the Display Flex.</p>  <p><b>latch</b> <b>cable harness</b>    <b>three screws</b></p> <p>b. Remove the two screws holding the metal isolator bracket to the display bezel.</p>  <p><b>two screws</b></p> <p>c. Shift the metal isolator bracket to access the flex circuit display connection. Lift up the rubber flap over the flex circuit where it connects to the display and remove the connection.</p> <p>d. Remove the flex circuit from the display bracket.</p> <p>e. Remove the metal isolator bracket from the display bezel.</p>	<p>Separate the monitor bezel from the LCD display.</p> <p>a. Remove the four screws holding the display shield to the LCD display and the two screws holding the display shield to the monitor bezel.</p> <p>○ four larger screws □ two smaller screws</p>  <p>b. Remove the display assembly from the monitor bezel.</p> <p>c. Pull the LCD display isolator out of the way. Disconnect the LCD display cable.</p>  <p><b>LCD display cable</b></p> <p>d. Disconnect the LCD display cable from the backlight inverter PCB.</p>  <p><b>LCD display cable</b></p>	<p>Separate the front bezel from the transition bezel.</p> <p>a. Remove the six screws from the back of the transition bezel.</p> <p><b>six screws</b></p>  <p>b. Open the two halves of the display bezel.</p> <p>c. Disconnect the front panel PCB flex cable from the key pad assembly.</p>  <p><b>flex cable</b></p>

8. Replace or upgrade the display assembly components. See the following sections to service your monitor.
  - “Replacing the Backlight Inverter PCB” on page 8-13.
  - “Replacing the Key Pad Assembly” on page 8-14.
  - “Replacing the LCD Color Display” on page 8-15.
  - “Replacing or Upgrading the Dash 4000 Alarm Light Option” on page 8-16.
  - “Replacing the Dash 4000 Front Panel PCB” on page 8-17.

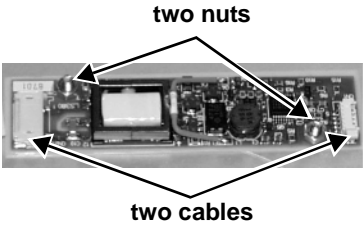
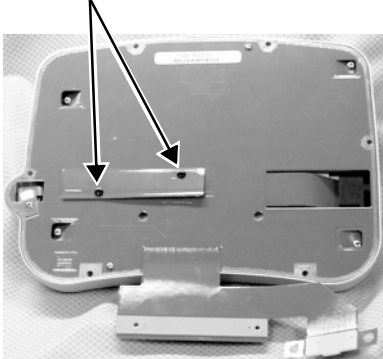
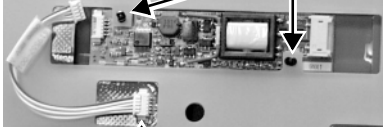
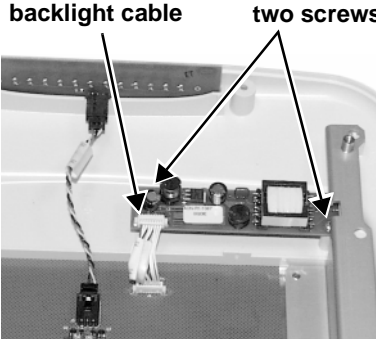

# Replacing the Backlight Inverter PCB

Complete the following steps for the monitor you are servicing.

Dash 3000 with color display flex circuit	Dash 3000 with display shield flex circuit	Dash 4000
<p>1. Remove the handle assembly. See page 8-7.</p> <p>2. Remove the display assembly from the main unit. See page 8-9.</p>		
<p>3. Remove and replace the backlight inverter. Follow the steps for the monitor you are servicing.</p>		
<p>a. Disconnect the two backlight cables. Remove the two nuts anchoring the backlight inverter PCB to the backlight assembly.</p> <hr/> <p><b>CAUTION</b></p> <p>Be careful when removing the nuts that you do not make contact with the board components. These components may crack or break off and make the PCB useless.</p> <hr/>  <p>two nuts</p> <p>two cables</p> <p>b. Replace the defective backlight inverter PCB and inspect the insulator inverter for pinholes. Prepare the insulator if required.</p> <p>c. To reduce future backlight failures, use a defect-free insulator and use nylon washers (one each) between the insulator inverter and the backlight inverter PCB.</p>	<p>a. Flip over the display shield flex circuit. Remove the male end of the two snap rivets.</p> <p><b>plastic snap rivets (male end)</b></p>  <p>b. Flip over the display shield flex circuit. Disconnect the display shield cable from the backlight inverter PCB.</p> <p><b>plastic snap rivets (female end)</b></p>  <p><b>display shield cable</b></p> <p>c. Use a screw driver to remove the female end of the two snap rivets. Do not re-use these rivets.</p> <p>d. Replace the defective backlight inverter PCB.</p>	<p>a. Remove the LCD color display. See page 8-15.</p> <p>b. Disconnect the backlight cable. Remove the two screws anchoring the backlight inverter PCB to the front panel PCB.</p>  <p><b>backlight cable</b>      <b>two screws</b></p> <p>c. Replace the defective backlight inverter PCB.</p>
<p>4. Reassemble the display assembly.</p>		

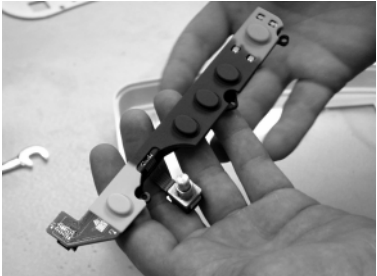
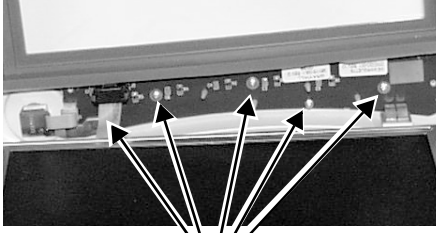

# Replacing the Key Pad Assembly

Complete the following steps for the monitor you are servicing.

Dash 3000 with color display flex circuit	Dash 3000 with display shield flex circuit	Dash 4000
<ol style="list-style-type: none"> <li>1. Remove the handle assembly. See page 8-7.</li> <li>2. Remove the display assembly from the main unit. See page 8-9.</li> </ol>		
<ol style="list-style-type: none"> <li>3. Remove the display assembly from the display bezel.</li> </ol> 	<ol style="list-style-type: none"> <li>3. Go to step "4."</li> </ol>	<ol style="list-style-type: none"> <li>3. Go to step "4."</li> </ol>
<ol style="list-style-type: none"> <li>4. Remove the rubber knob from the Trim Knob control shaft.</li> <li>5. Use an 11mm wrench or nutdriver to remove the nut holding the Trim Knob control's shaft to the display bezel.</li> </ol> 		
<ol style="list-style-type: none"> <li>6. Remove the three screws holding the key pad assembly to the display bezel.</li> </ol>  <p>three screws</p>	 <p>Keypad Assembly FRU</p>	<ol style="list-style-type: none"> <li>6. Remove the five screws holding the key pad assembly to the front bezel.</li> </ol>  <p>five screws</p>
<ol style="list-style-type: none"> <li>7. Place the new key pad assembly in the display bezel. Make sure the washer tab fits in the retaining slot of the Trim Knob control's shaft and replace the 11mm nut.</li> <li>8. Fasten the new key pad with the screws removed earlier.</li> <li>9. Reassemble the display assembly.</li> </ol>		

# Replacing the LCD Color Display

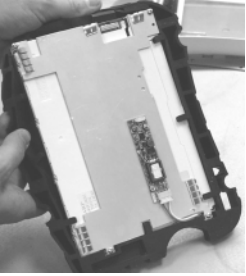
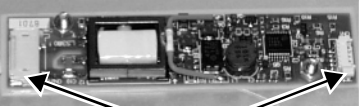
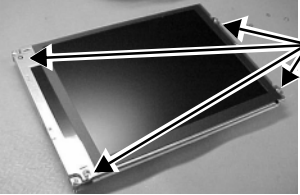
Complete the following steps for the monitor you are servicing.

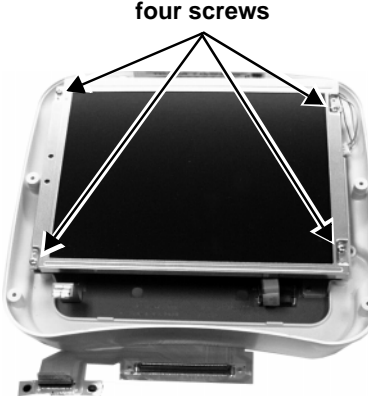
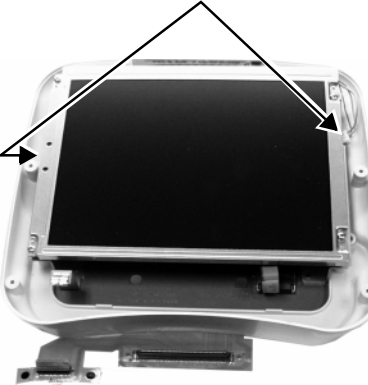
Dash 3000 with color display flex circuit	Dash 3000 with display shield flex circuit	Dash 4000
<p>1. Remove the handle assembly. See page 8-7.</p> <p>2. Remove the display assembly from the main unit. See page 8-9.</p>		
<p>3. Remove the LCD display. Follow the steps for the monitor you are servicing.</p>		
<p>a. Remove the display assembly from the display bezel.</p>  <p>b. Peel back and remove the rubber display isolator from around the display.</p>  <p>c. Disconnect the two backlight cables.</p>  <p style="text-align: center;">two cables</p> <p>d. Remove the four nuts anchoring the display ground plate to the LCD display.</p>  <p style="text-align: right;">four nuts</p>	<p>a. Peel back and remove the rubber display isolator from around the display.</p> 	<p>a. Remove the four screws anchoring the display to the display brackets.</p>  <p style="text-align: center;">four screws</p> <p>b. Disconnect the LCD display PCB cable from the back of the display. Disconnect the backlight inverter PCB cable from the backlight inverter.</p>  <p style="text-align: center;">two cables</p>
<p>4. Replace the defective LCD display and reassemble the display assembly.</p>		

## Replacing or Upgrading the Dash 4000 Alarm Light Option

You must disassemble most of the display assembly to replace or upgrade the alarm light option.

1. Remove the handle assembly. See page 8-7.
2. Remove the display assembly from the main unit. See page 8-9.
3. Remove the LCD color display. See step “3.” on page 8-15.
4. Complete the following steps identified for your service procedure.

Alarm Light Replacement	Alarm Light Upgrade (FRU)
<ol style="list-style-type: none"> <li>a. Remove the clear plastic cover.</li> <li>b. Disconnect the Alarm Light cable from the front panel connector.</li> <li>c. Replace the defective Alarm Light PCB.</li> </ol>	<ol style="list-style-type: none"> <li>a. Remove the blank plastic cover.</li> <li>b. Insert the Alarm Light PCB into the slot.</li> <li>c. Connect the Alarm Light cable to the front panel connector.</li> </ol>

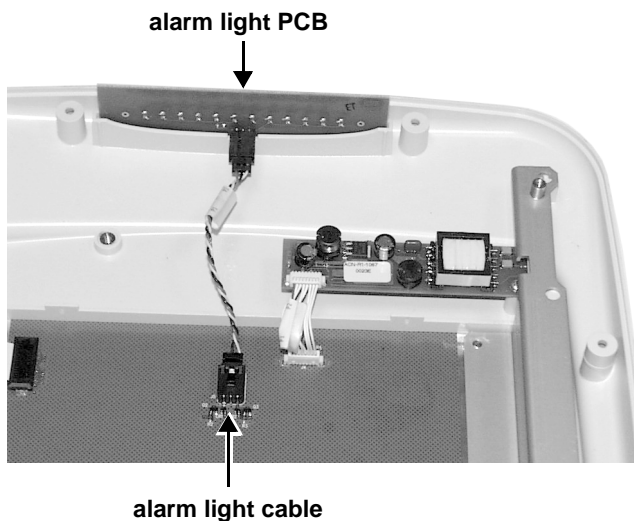

5. Replace the clear plastic cover and reassemble the display assembly.

## Replacing the Dash 4000 Front Panel PCB

You must disassemble the entire display assembly to replace the front panel PCB.

1. Remove the handle assembly. See page 8-7.
2. Remove the display assembly from the main unit. See page 8-9.
3. Remove the LCD color display. See step “3.” on page 8-15.
4. Remove the backlight inverter PCB. See step “3.” on page 8-13.
5. Disconnect the Alarm Light cable from the front panel PCB. See step “4.” on page 8-16.
6. Remove the four screws anchoring the front panel PCB to the rear display mounting brackets. Remove the two screws anchoring the front panel PCB to the transition bezel.

 four larger screws

 two smaller screws



7. Replace the defective front panel PCB.
8. Reassemble the display assembly.

## Main Unit Components

### DAS and NBP Assemblies

1. Remove the four screws anchoring the Data Acquisition System (DAS) assembly in place.

---

---

#### CAUTION

*Carefully* remove the DAS assembly so that you **do not** hit the components on the processor/power management PCB.

---

---

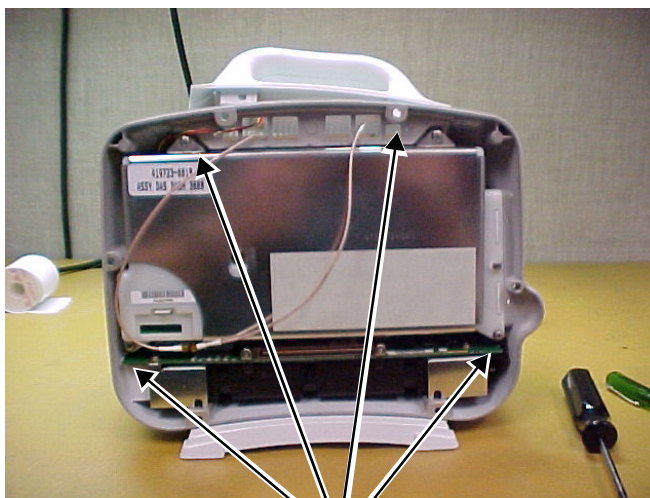

DAS assembly screws

2. Remove the DAS assembly by first pulling the *left* side out 1/4-inch, then sliding the whole assembly out of the monitor. Use needle nose pliers to remove both coax connectors from the PC card.

***If you need to replace the main assembly, the power supply assembly, and/or the speaker***, go to “Main and/or Power Supply Assemblies, Speaker” later in this chapter.

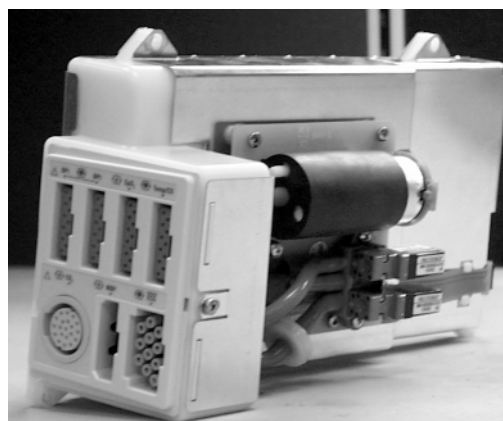



3. Remove the four screws and remove the NBP assembly from the cover of the DAS assembly.
4. Remove the tube going into the NBP assembly.

**Screws holding the NBP PCB to the DAS assembly.**

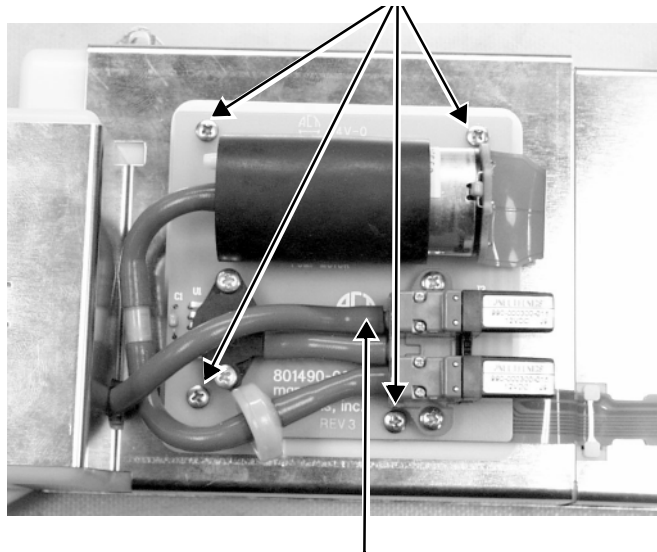

**Tube going to the NBP assembly.**

5. Using a small, flat-blade screwdriver, remove the connector from the NBP assembly to the DAS assembly.

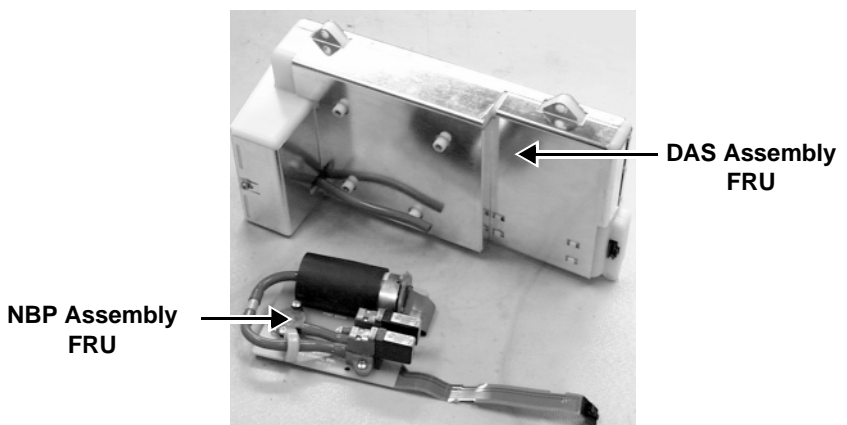

6. ***If you need to replace the DAS assembly***, attach the NBP assembly to the new DAS assembly.

***If you need to replace the NBP assembly***, attach the new NBP assembly to your unit's DAS assembly.

7. Reassemble the DAS and NBP assemblies. Make sure you do not forget:
- the four mounting screws,
  - the tube connection, and
  - the flex connector.

Reassemble the monitor in reverse order.

## Main and/or Power Supply Assemblies, Speaker or RF LAN Upgrade

1. *If your unit has the writer option*, remove the writer by unscrewing the two captive screws inside the writer.

---

---

### CAUTION

Make sure you approach the screw from *below* the top bar on the paper roll holder so that you do not damage the unit.

---

---

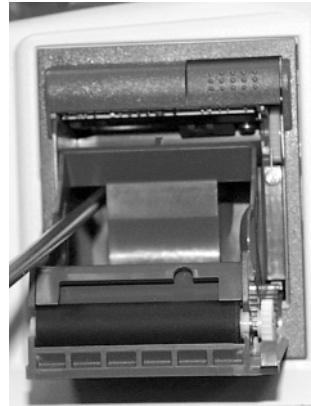

2. Unscrew the thumb screw anchoring the writer cable to the main assembly and disconnect the flex cable from the processor/power management PCB.

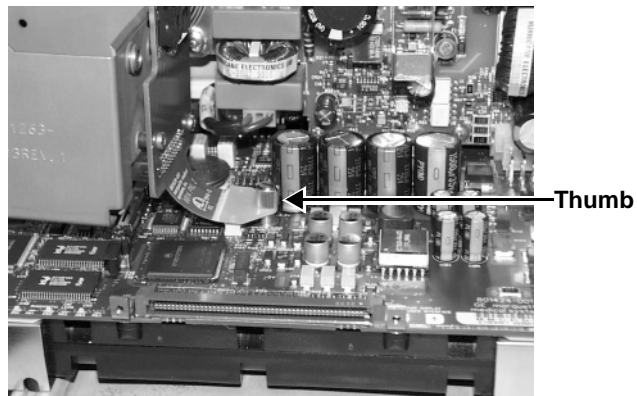

3. Remove the speaker harness and the optional alarm light cable harness from the top of the writer board.
4. Remove the handle of the monitor and set aside.

5. Remove the writer bracket from the frame.

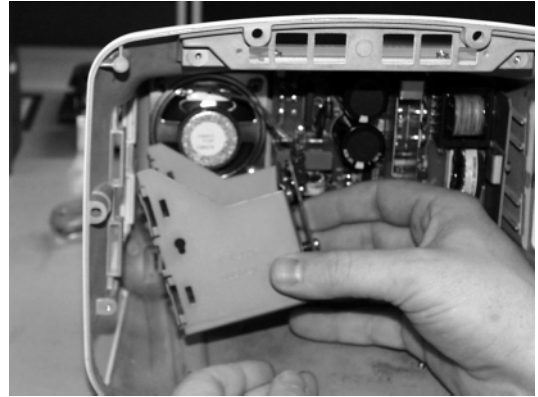

6. *If you need to replace the speaker*, go to “Speaker.”

Follow these steps to replace the processor/power management PCB and Battery assembly.

1. Remove the three screws anchoring the battery door assembly to the rear housing. Remove the battery door assembly.

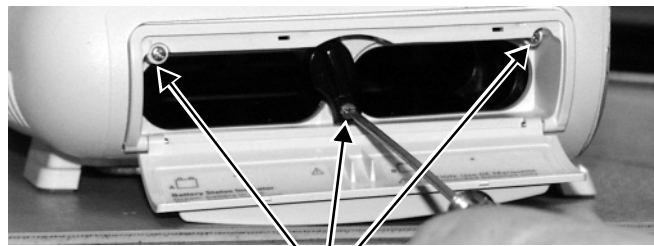

**Screws holding battery door.**



**Battery Assembly FRU**

## Processor/Power Management PCB and Battery Assembly

2. Remove the four panhead screws anchoring the processor/power management assembly to the frame. These screws are attached at the bottom of the unit.

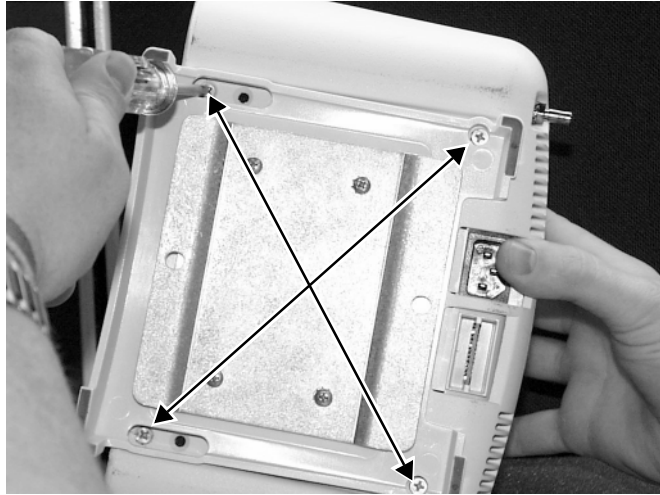

3. *Carefully* pull the main assembly from the unit.



4. ***If you need to replace the power supply***, go to “Power Supply Assembly.”
5. ***If you are upgrading with RF LAN***, go to “RF LAN Upgrade.”
6. Remove the plastic connector panel from the three connectors at the back of the processor/power management PCB. Install this panel on the new processor/power management PCB before you slide the new assembly into the rear housing.



Plastic Connector Panel

7. Install the new assembly in the unit.
8. Reassemble in reverse order.

## Power Supply Assembly

To replace the power supply assembly, follow these steps.

1. While holding the power supply assembly with one hand, remove the four screws from the back of the unit.

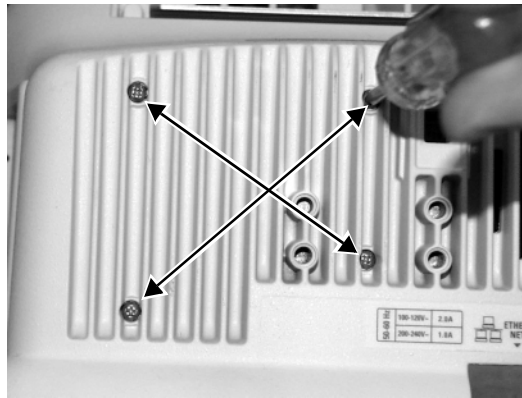

2. Remove the assembly from the unit.

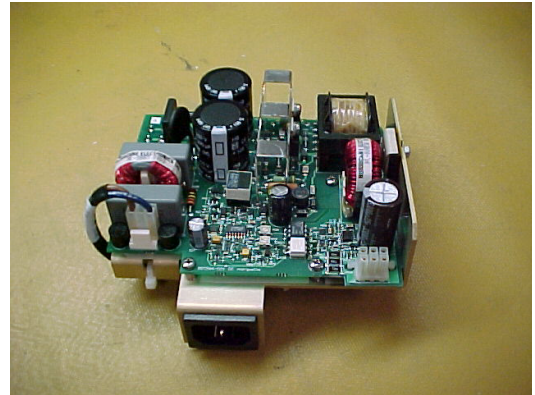

3. Align the tab on the power supply mounting bracket with the slot in the rear housing and install the new assembly in the unit. Fasten the assembly to the rear housing with the screws you removed earlier.

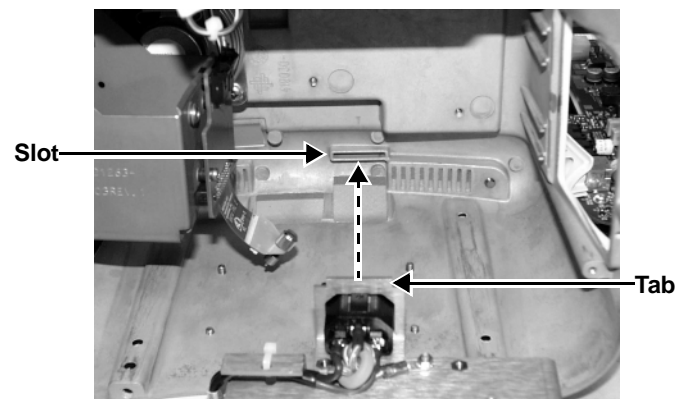

4. Reassemble in reverse order.

## Speaker

To replace the speaker, follow these steps.

1. Remove the four screws anchoring the speaker to the frame. Remove the speaker from the unit.

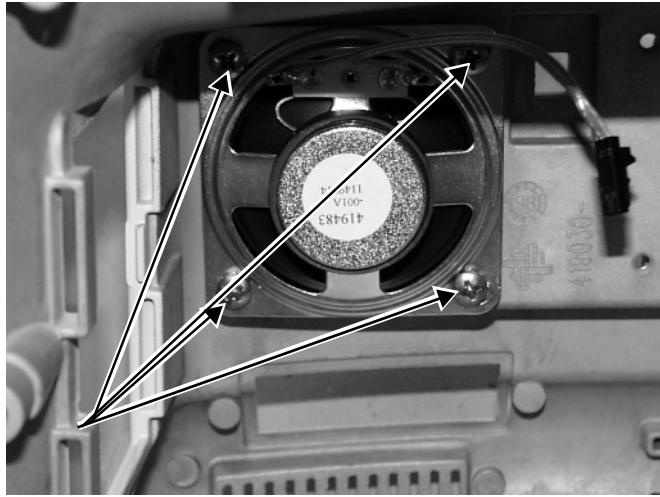

2. Install the new speaker in the unit with the cable harness positioned at the top (as shown above). Fasten the speaker with the four screws.
3. Reassemble in reverse order.

## RF LAN Upgrade Instructions

1. Remove seven (M3 x 6L) screws from the Processor Power management PCB.

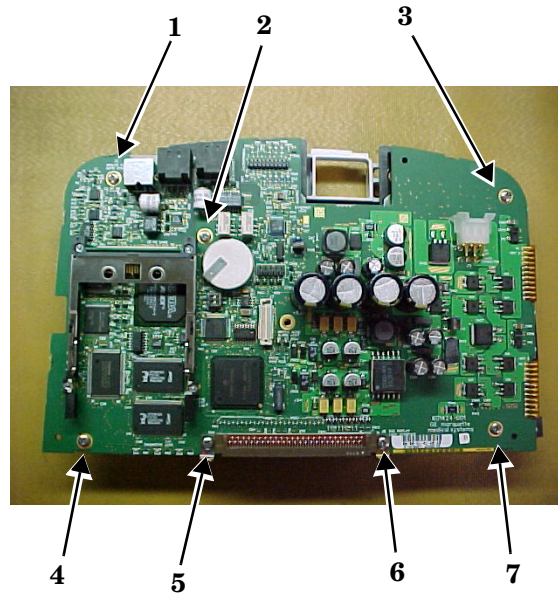

2. Remove the two (M4 x 10L) screws holding on the Expansion connector housing.

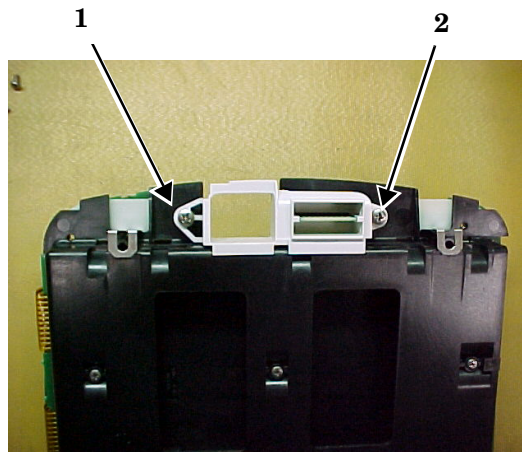

3. Pull out the Expansion connector housing.

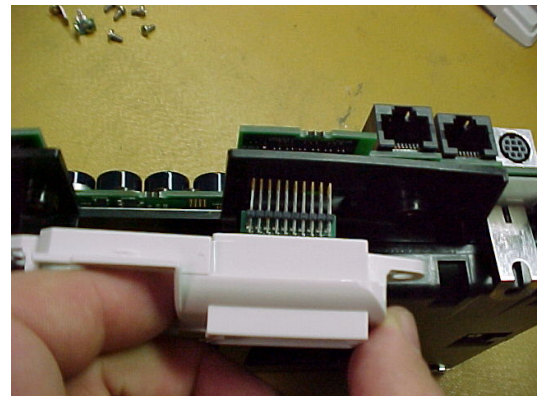



4. Flip over the Processor/Power Management PCB to expose the backside of the PCB.

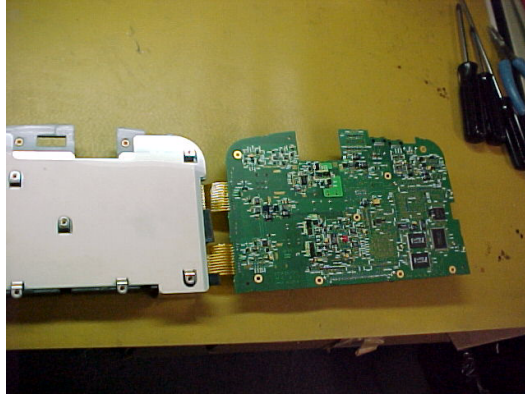

5. Remove the four (M2 x 12L) screws that hold on the PC card socket to the Processor/Power Management PCB. Be careful not to drop the four (M2) nuts captured in the PC card socket when removing these screws. Pull the screws out of the PCB and set aside.

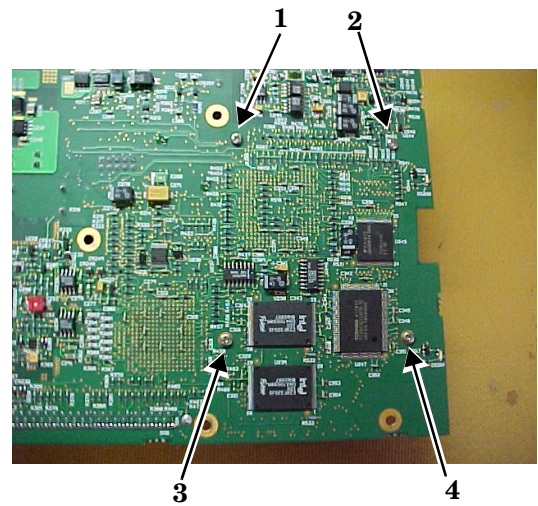

6. Flip over the PCB and remove the PC Card socket from the edge connector.

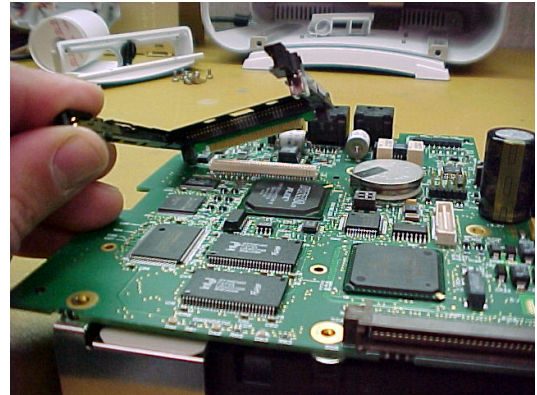

7. With the PC Card socket removed, place the HEX (M2) nuts back into the PC Card socket (if they fell out earlier). Slide the RF LAN shield around the PC Card socket. Use care not to bump the nuts out of their position.

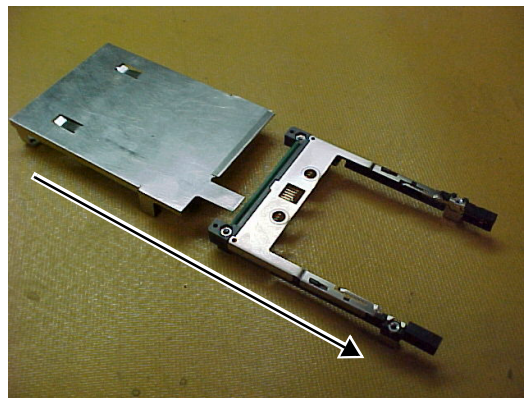

8. Be sure to have the RF shield in place so the holes line up on the underside. The HEX nuts are captured in the PC Card socket and are held into place by the shield.

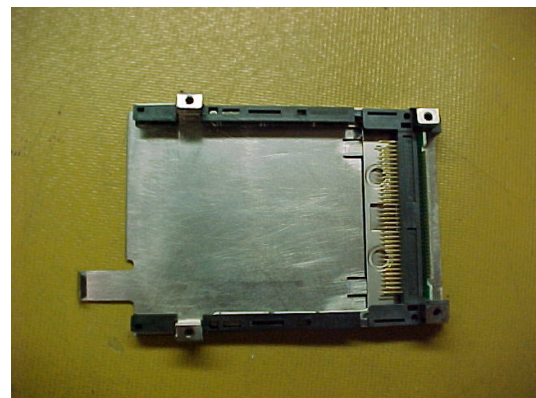

9. Install the PC Card socket with the attached RF LAN shield into the card edge connector on the PCB.

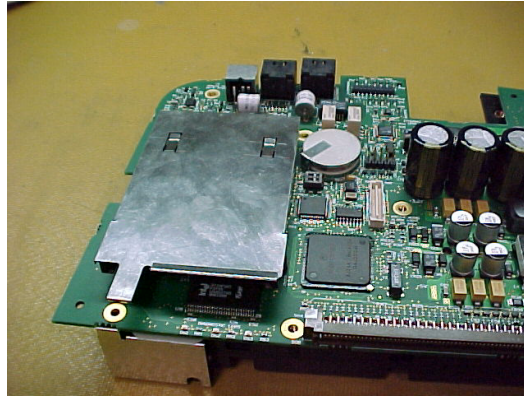

10. Flip over the PCB again. With the PC Card socket in place, install the four screws and tighten.

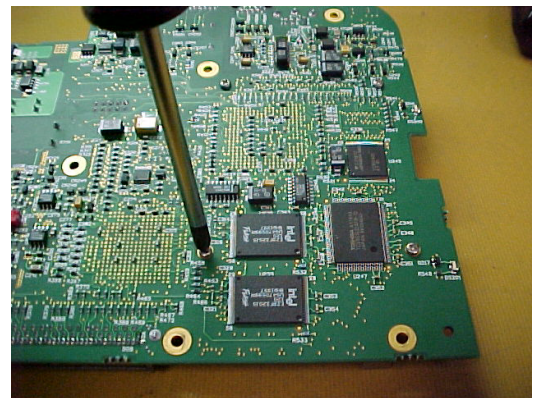

11. Install the seven screws from Step 1. Note: Do not place a screw next to J7.
12. Apply the supplied regulatory label below the Symbol PC Card's existing label. See the RF LAN kit for the label.
13. Install Symbol PC Card. Note: Clip to hold card in place.

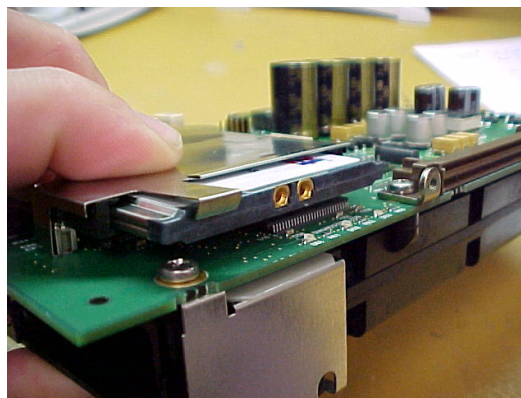

14. Install Expansion connector housing as done in Steps 2 and 3.
15. Install Panel connector back onto the back of the Processor/Power

Management PCB before you slide the assembly back into the monitor's housing.

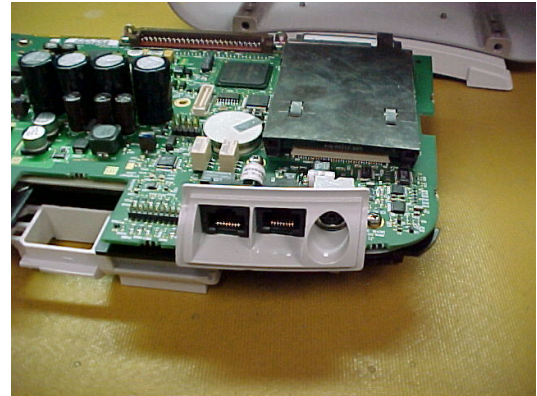

16. Slide the Processor/Power Management assembly back into the monitor's housing.

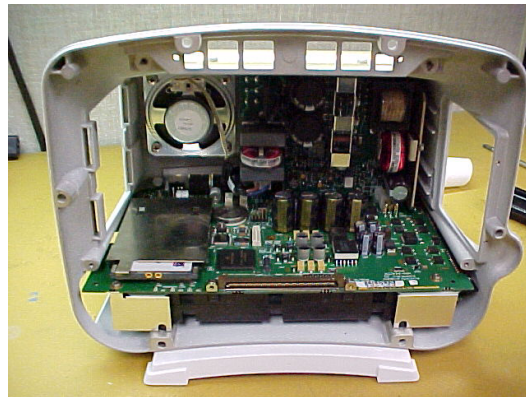

17. Install the four panhead screws.

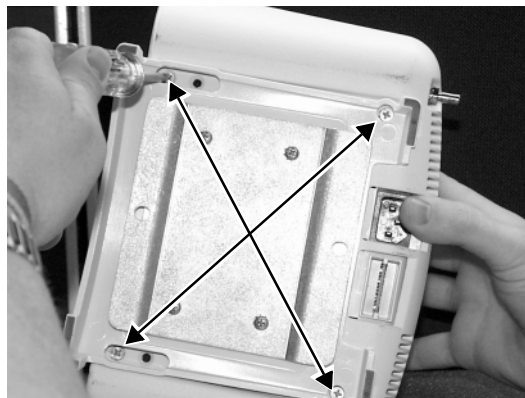

18. Re-install the battery door Assembly.



19. Install writer bracket in place. Connect the speaker cable to the writer flex circuit. Connect the writer flex to J7 on the Processor/ Power Management PCB and secure it with the thumbscrew.

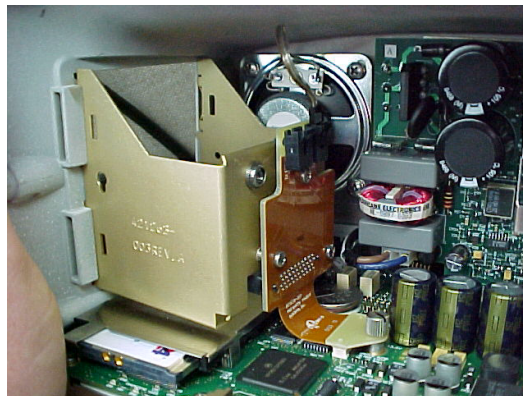

20. Install writer (if equipped) or blank plate. (Writer option shown here.)

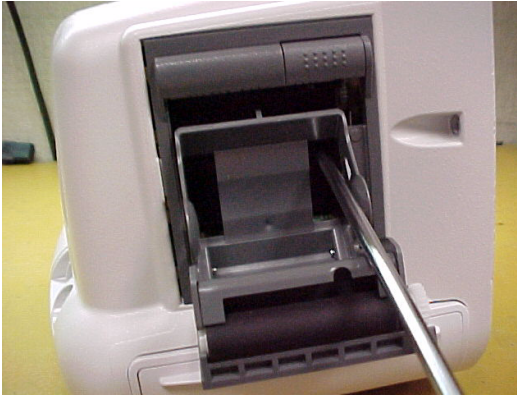

21. Disassemble the handle assembly by removing top two screws.
22. Install the RF LAN antennas as shown into the plastic grooves. The antenna could be held in place with adhesive or sticky tape to help aid in reassembly of the handle.

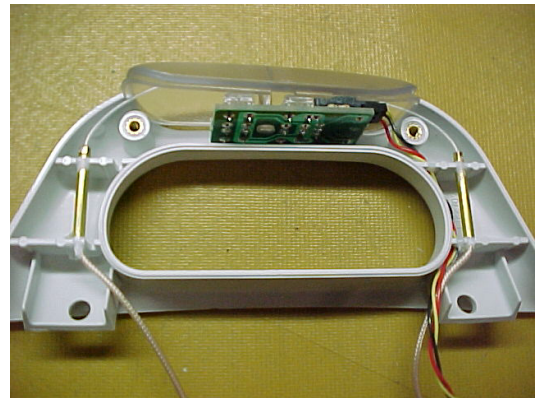

23. Reassemble the handle with the top two screws. Route cables out the bottom of the handle as shown as to not pinch antennas between the handle halves.

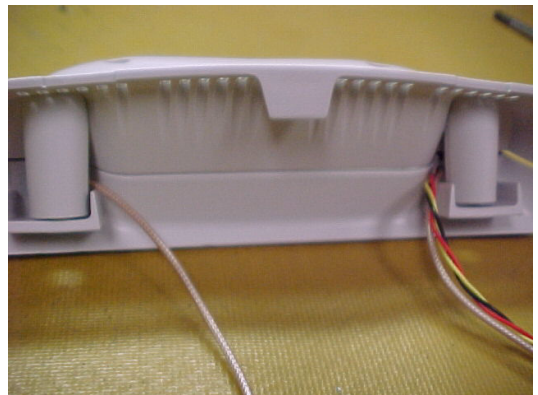

24. Route cables into the monitor's housing as shown. Connect the alarm cable to the writer bracket.

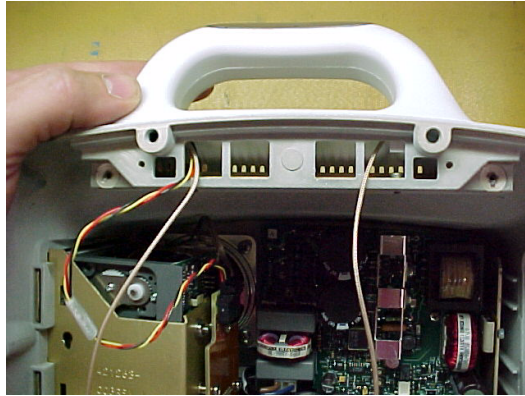

25. Reinstall DAS assembly. When installing the DAS assembly, it is critical not to pinch the coax's or alarm light cable. Route alarm light cable behind the DAS and off to the side of the upper left mounting screws as shown in the picture below. Use four screws (M3 x 12L with washers) to mount the DAS.

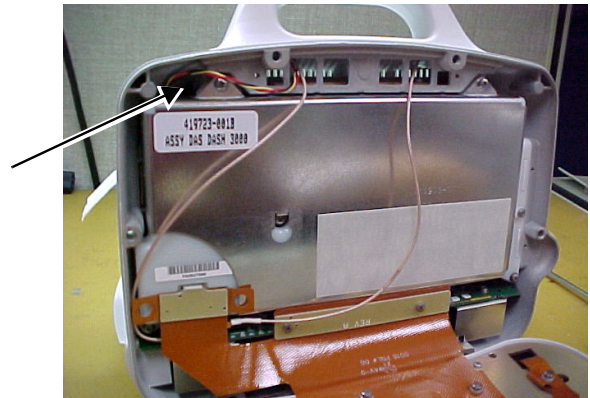

26. Use needle nose pliers to snap the two coax connectors into the Symbol PC card. Route coaxes per the picture. Note that the left coax is routed above the RF LAN shield retaining clip.



27. Reinstall Display assembly. Use two (M3 x6L) screws to mount the flex to the Processor/Power management PCB.

28. Reconnect the display flex to the DAS assembly. During assembly, verify the RF LAN coaxes are not pinched between the front bezel assembly and the rear housing.

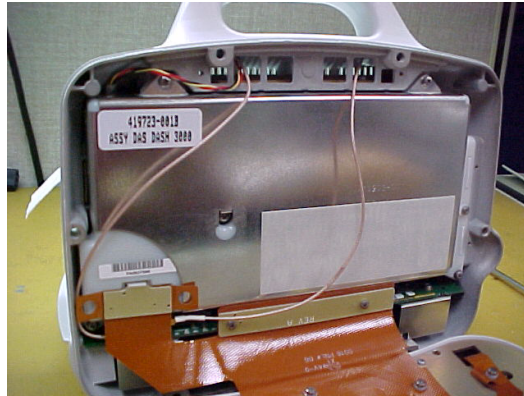

29. Reattach the display assembly to the monitor's rear housing. It is helpful to lay the monitor face down on a non-abrasive, static-free surface. Make sure the Trim Knob control hangs over the edge of the surface to prevent damage.
- Top screws are M4 x 28L
  - Side screws are M4 x 16L
  - Bottom screws are M4 x 25L
30. Adhere RF LAN label to the rear of the monitor as shown.

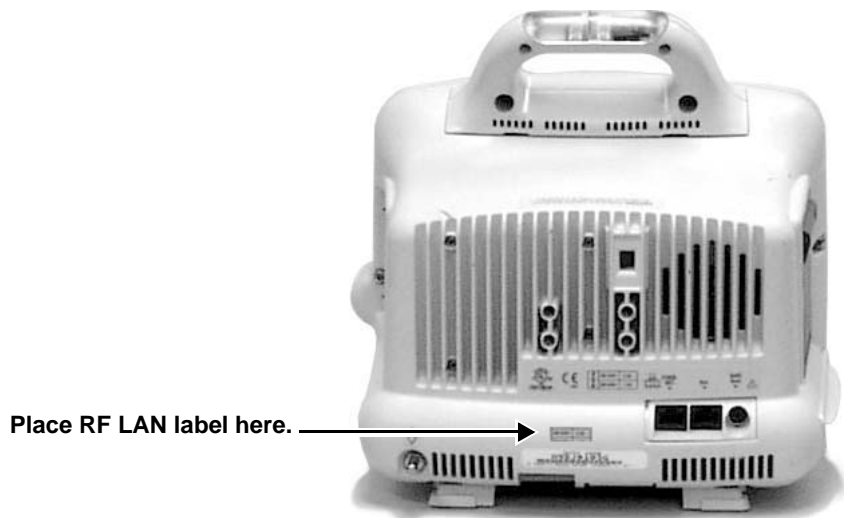

31. Reinstall the batteries and plug into AC power and verify that Wireless LAN is enabled.



## Verify Wireless LAN is Enabled

Confirm the configuration of the optional Wireless LAN.

Activate the Boot Code:

1. Hold down **NBP Go/Stop** and **Function**.
2. Press and release the Trim Knob control.
3. Keep holding **NBP Go/Stop** and **Function** until the Boot Code information appears on the display.
4. Select *SERVICE MENU* -> *SET CONFIGURATION*.
5. In the *Configuration Menu*, select *Configure Wireless LAN*.
6. Select *Set SSID to factory default*.
7. Verify Wireless LAN is *Enable*.
8. *Select Exit -> Exit*. Reboot the monitor (press and release **NBP Go/Stop**, **Function** and the Trim Knob control).

## Verify the Wireless LAN ID Number

1. Select *MORE MENU* -> *MONITOR SETUP* -> *REVISION AND ID*.
2. Select *Next* -> *Next*.
3. Verify that *WIRELESS LAN ID* is showing *US 02 V4.63 xxxxxx*. If no ID is displayed,
  - recheck the setup in the Boat Loader menu, or
  - check if the Symbol PC card is installed correctly

## Verify Wireless LAN Communications

1. Connect a Symbol Access Point with AC power and a Unity MC Network node. Refer to the Wireless LAN (Symbol Access Point) Installation and Service Manual. Power up the access point
2. Disconnect the Ethernet line from the back of the monitor then connect a patient simulator to display ECG waveforms on the monitor's display. Verify the unit name matches the unit name at the central station. Admit the patient at the monitor.
3. Verify waveforms are displayed at the central station for the monitor.
4. Connect the Ethernet jack to the back of the monitor. Verify that no more than three seconds of drop out occurs at the central station during the network switch over.
5. With the monitor now operating on the Ethernet connection, disconnect the Ethernet jack from the back of the monitor and verify that no more than three seconds of drop out occurs at the central station during the network switch over.
6. Place the simulator into a Crisis alarm and verify the audio on the speaker is functional and that the Alarm Light (if installed) is flashing RED when in alarm.
7. Discharge test patient and remove all cables. **End of test**.

# Optional DDW Writer Replacement/Upgrade

## Replacement

**NOTE:** You do not need to disassemble the monitor to replace or upgrade the optional printer.

1. Remove the writer by unscrewing the two captive screws inside the writer.

---

---

### CAUTION

Make sure you approach the screw from *below* the top bar on the paper roll holder so that you do not damage the unit.

---

---

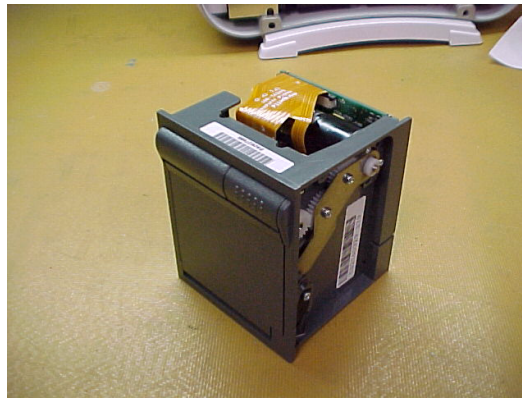

**2-Inch Writer Assembly FRU**

2. Remove the writer from the unit.
3. Insert the new writer into the rear housing to engage with the blind mate connector.
4. Secure the writer with the two captive screws inside the writer.

**NOTE:** Perform the Graph Test in chapter four, Maintenance.

## Upgrade

If upgrading the monitor to add a writer, pry off the blank cover with a flat blade screw driver. The cover may crack or break when removing. Once the cover is removed it can be discarded. Proceed with steps 3 and 4 above.

# 9 ASSEMBLY DRAWINGS

*For your notes*

# Introduction

Included in this section is the Theory of Operation along with a complete set of engineering assembly drawings for monitors configured with the TFT color display. These drawings provide reference for components of the monitor in the form of mechanical and electrical diagrams.

The assembly drawings for all of the monitors configurations are broken down as follows:

**Electrical diagrams** — These diagrams provide a reference to electrical assemblies in the monitors.

**Packing materials** — These diagrams provide reference to the manufacturer shipping container used for the monitors.

**Exploded views** — These diagrams provide reference to the individual parts used in the monitors.

**Parts Lists** — These lists provide part number and descriptive cross-reference to all parts and subassemblies found in each of the drawings.

**Port Connections** — These photos and tables provide signal information for the various connectors on the monitors.

# Theory Of Operation

## General Monitor Block Theory

The monitor is a portable patient monitor manufactured in various fixed configurations:

- 3/5/10-leadwire ECG,
- respiration,
- pulse oximetry,
- NBP, and
- two temperatures are standard on all models;
- 12SL,
- BP,
- CO, and
- CO<sub>2</sub> are software options.

The “7015” software feature level provides the base feature set; additional software options are provided by the “7020” and “7025” feature levels. Options are configured at the time the monitor is manufactured. The monitor comes with a color active-matrix display. Other hardware options include thermal printer and an alarm light. Software options can be upgraded in the field by use of a password unique to each monitor and feature.

Unity Network (twisted-pair Ethernet), Aux (async serial communication channel), and defibrillator synchronization/analog output interfaces are standard on all monitors.

Many languages are bundled into one software package and selected in the boot menu. You must install Asian languages separately.

To obtain a more detailed theory of operation, attend one of the formal technical training classes. Regularly scheduled technical training classes are held throughout the year at the GE Medical Systems *Information Technologies*’ training facility located in Jupiter, Florida. If warranted, technical training classes can be scheduled at customer sites or other locations in the field as well.

## Components

The monitor is housed in a single package. The main components of the assembly are:

- User Interface,
- Power Supply,
- Data Acquisition System,
- Processor/Power Management subsystem (including battery case and expansion connector),
- Speaker,
- Handle subassembly (including the Alarm Light option), and
- Thermal Printer (optional).

## Overall Monitor Block Diagram

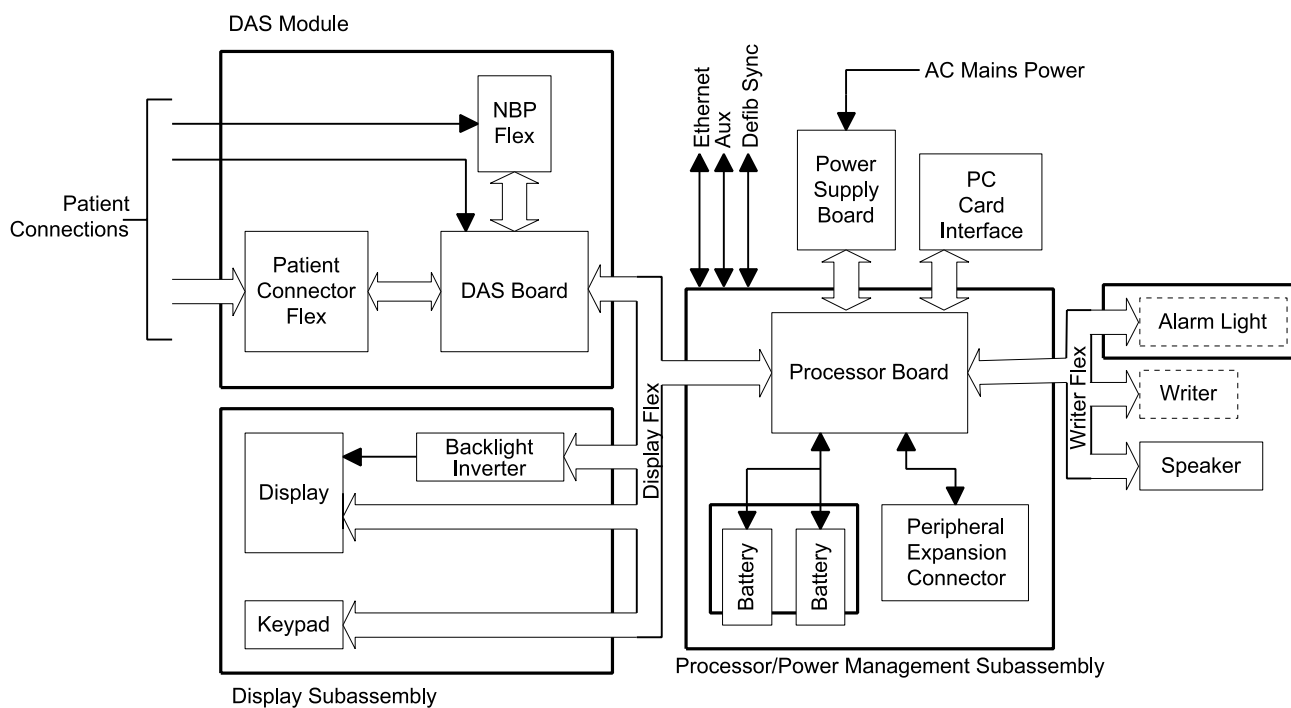

## User Interface

The User Interface consists of a flat panel display and the keypad assembly which consists of a Trim Knob, five function keys, and four LED indicators. (Additional indicators are contained in the Processor/Power Management subsystem.)

### Flat Panel Display

The active-matrix color liquid crystal display (LCD) is assembled into a shock absorbing isolator that fits within the monitor's front bezel to protect the display from mechanical shock during use.

The acrylic optical filter protects the display panel from impact and enhances visibility with its non-glare surface coating on the viewing side of the filter. It also has a scratch-resistance surface coating.

### Trim Knob Control

The Trim Knob control is a 24-position rotary control with a push selection switch.

### Power Key

The monitor is powered at all times when it is plugged into AC power.

When the monitor is not plugged in to AC power, this key turns the monitor On and Off.

When AC power is present, this key toggles the operational mode of the monitor between normal operation and stand-by mode. In standby mode patient monitoring discontinues. Only the charging function continues and the charging status indicators operate as described below.

### Function Keys

#### Fixed Keys

Three fixed function keys are provided for **Graph Go/Stop, NBP Go/Stop, and Silence Alarm.**

#### Programmable Key

The **Function** key is the only programmable key. This key is provided for the user to assign a frequently used function of the monitor. Currently this key only performs the "Zero All" function.



## Indicators

While the monitor powers up or changes between normal mode and standby mode, all four front panel indicators illuminate.

### AC Power Indicator

The indicator illuminates green when AC mains power is applied to the monitor (including when the monitor is in the standby mode). The indicator does not illuminate when the monitor is not powered by AC mains power.

### Battery Power Indicator

The indicator illuminates yellow when the monitor is operating on battery power. The indicator does not illuminate when the monitor is not battery powered.

### Charging Status Indicators

The following table explains what the Charging Status indicators mean.

LED Color	Explanation:
Yellow	Two battery icons, labeled Charging Status A and B, illuminate yellow when the respective battery is being charged. If both batteries are present and require charging, then both icons illuminate yellow even though they charge sequentially.
Green	The icon illuminates green when the respective battery is fully charged.
No Light	The icon does not illuminate under the following conditions: <ul style="list-style-type: none"> <li>• The respective battery is not installed.</li> <li>• The monitor is operating on battery power.</li> <li>• A failure condition has been detected for the respective battery.</li> </ul>

### “Battery In Use” Indicators

The “Battery In Use” indicator (inside the battery door) illuminates green when the monitor is receiving power solely from the respective battery. The indicators do not illuminate when the monitor is not battery powered.

Neither indicator illuminates when the monitor is operating from both batteries simultaneously (i.e., in a very low battery charge condition when both batteries are joined together in order to sustain operation of the monitor).

## Power Supply

The subsystems within the monitor operate from a common 9 to 18 V power bus. Due to the wide variety of voltages required by the various subsystems, power is converted locally by each subsystem. This architecture results in an efficient and compact system by reducing the number of conversions required and optimizing the physical size of each converter for the specific application.

When operating on AC mains power, the power bus voltage is 18 V, generated by the offline switching power supply.

No AC mains power switch is provided.

The line voltage range switch must be set to select 115 V or 230 V (90 to 132 VAC or 190 to 264 VAC, respectively).

## Data Acquisition System (DAS)

All interfaces to the patient occur through the DAS. The ECG function uses a direct connection to the patient; therefore it is separately isolated from the other functions (except respiration, which shares the ECG patient interface) to substantially eliminate coupling of noise and leakage currents to/from other functions. All remaining DAS functions (i.e., pulse oximetry, NBP, invasive pressure, temperature, cardiac output, and CO<sub>2</sub>) share a common isolation barrier.

Block Diagram

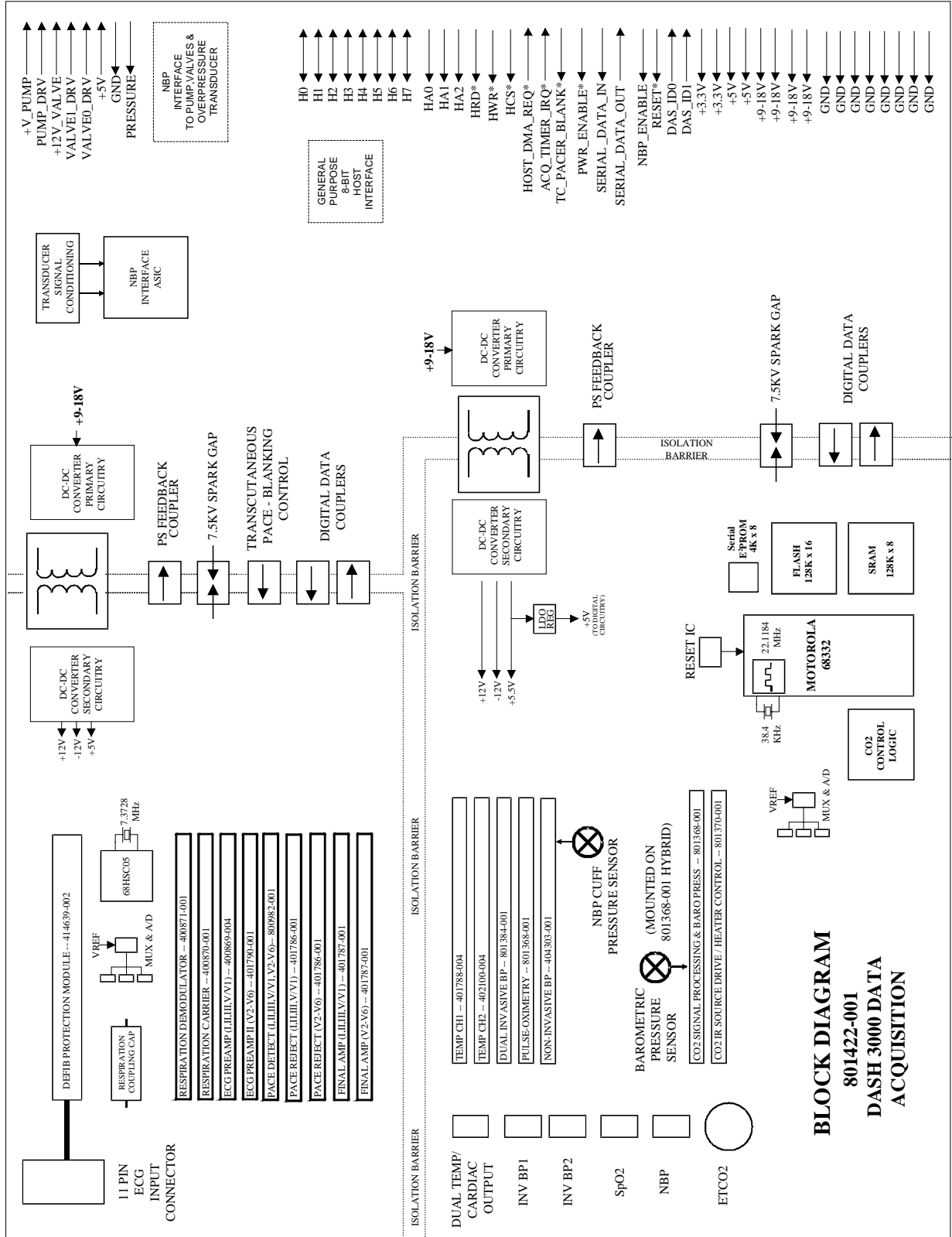

**BLOCK DIAGRAM**  
**801422-001**  
**DASH 3000 DATA**  
**ACQUISITION**

## ECG

The ECG function detects heartbeats and arrhythmias, measures heart rate (HR) and ST segment deviation, and generates a 12SL diagnostic interpretation. Patient alarms with adjustable high and low limits for HR and ST segment deviation are provided. Additional patient alarms are provided for arrhythmias and PVCs. System alarms for individual lead failure and all leads failure are provided.

The monitor accepts the green 3, 5, and 10-leadwire Multi-link ECG connectors (compatible with Eagle 3000 monitor, Eagle 4000 monitor, and Tram modules).

## Respiration

The respiration function measures respiration rate (RR) and detects apnea through the ECG leadwires using the impedance variation technique. Patient alarms for RR (with adjustable high and low limits) and apnea (with adjustable time limit) are provided. System alarms for lead failure, cardiac artifact, and learning are provided.

## Pulse Oximetry (SpO<sub>2</sub>)

The pulse oximetry function measures arterial oxygen saturation (SpO<sub>2</sub>) and peripheral pulse rate (PPR). Patient alarms with adjustable high and low limits for SpO<sub>2</sub> and PPR are provided. System alarms for probe off patient, low-quality signal, and pulse search are provided.

The monitor accepts the blue color-coded pulse oximetry connector (compatible with Eagle 3000 monitor, Eagle 4000 monitor, and the Tram x50-series modules). The monitor supports GE Medical Systems *Information Technologies*' and Nellcor probes. The probe type is determined by identification signals in the probe adapter cable.

## Non-Invasive Blood Pressure

The NBP function measures systolic pressure, diastolic pressure, mean pressure, and heart rate. Patient alarms with adjustable high and low limits for systolic, diastolic, and mean pressures are provided. System alarms for deflation failure, inflation failure, maximum pressure exceeded, measurement time exceeded, pulse too weak, hardware malfunction, and system pressure leak are provided.

The NBP function operates in manual, auto, and stat measurement modes. The monitor has backup protections for magnitude and duration of applied cuff pressure (with different settings in adult and neonatal modes).

The monitor accepts the rectangular NBP connector (compatible with the Eagle 3000 monitor and some versions of the Tram module).

## Invasive Pressure

The invasive pressure function measures two blood pressures and calculates systolic pressure, diastolic pressure, mean pressure, and pulsatile pressure rate where applicable. Patient alarms with adjustable high and low limits for systolic pressure, diastolic pressure, mean pressure, and pulse rate are provided for each channel. System alarms for sensor status (failure and disconnected), Smart BP event (artifact), zeroing status (not zeroed, failure, and pressure sensed), and PA Wedge status (wait, inflate, processing, complete, and no pulse) are provided.

The user can set an adjustable low-pass filter to 12 or 40 Hz. The 12 Hz filter is implemented in software; the filter is disabled at the 40 Hz setting.

The monitor accepts the red color-coded invasive pressure connectors (compatible with the Eagle 3000 monitor, Eagle 4000 monitor, and Tram modules).

## Temperature

The temperature function measures two temperatures. Patient alarms with adjustable high and low limits for temperature are provided. System alarms for sensor and calibration failures are provided.

The monitor accepts the brown color-coded connector (compatible with the Eagle 3000 monitor, Eagle 4000 monitor, and Tram modules). The monitor supports both YSI Series 400 and 700 thermistor probes. The probe type is determined by identification signals in the probe adapter cable.

The temperature connector and measurement circuits are shared with the cardiac output monitoring function; therefore you cannot use both functions concurrently. A signal in the patient cable indicates the appropriate function.

## Cardiac Output

The cardiac output function measures blood temperature and injectate temperature, and uses the thermal dilution method to calculate cardiac output. Patient alarms with adjustable high and low limits for blood temperature are provided. System alarms for sensor failure and unstable blood temperature are provided.

The monitor accepts the brown color-coded connector (compatible with the Eagle 4000 monitor and Tram modules).

The cardiac output connector and measurement circuits are shared with the temperature monitoring function. You cannot use both functions concurrently. A signal in the patient cable indicates the appropriate function.

## Carbon Dioxide (CO<sub>2</sub>)

The CO<sub>2</sub> function measures inspired and expired CO<sub>2</sub> and respiration rate using the infrared light absorption technique. The monitor connects to an external Novametrix Capnostat III sensor that clips to an airway adapter in the patient's ventilation circuit. The circuits to drive the sensor and process its incoming signal are located within the DAS.

Patient alarms with adjustable high and low limits for inspired CO<sub>2</sub>, expired CO<sub>2</sub>, and respiration rate are provided. An additional patient alarm for no breath detected is provided. System alarms for various sensor conditions are provided.

The monitor accepts the yellow color-coded connector.

## **Processor/Power Management Subsystem**

### Overview

The main processor/power management PCB contains the electrical hardware to provide data processing and display of patient and monitor configuration data, communication and interface circuitry, and power conversion and battery management functions for the monitor.

The high level of integration attained in the design of the Processor/Power Management PCB is attributed to the use of several highly integrated devices. A complex communications controller, ASIC, and battery management hardware significantly improve the performance and reduce the complexity and cost of the assembly. In addition to the CPU, the main microcontroller contains a six-channel communications processor as well as memory, PC Card, and video controllers. The devices used in the core processing architecture all operate at 3.3 V to minimize power consumption, yet the main processor and ASIC are tolerant of 5 V hardware peripherals.

Block Diagram

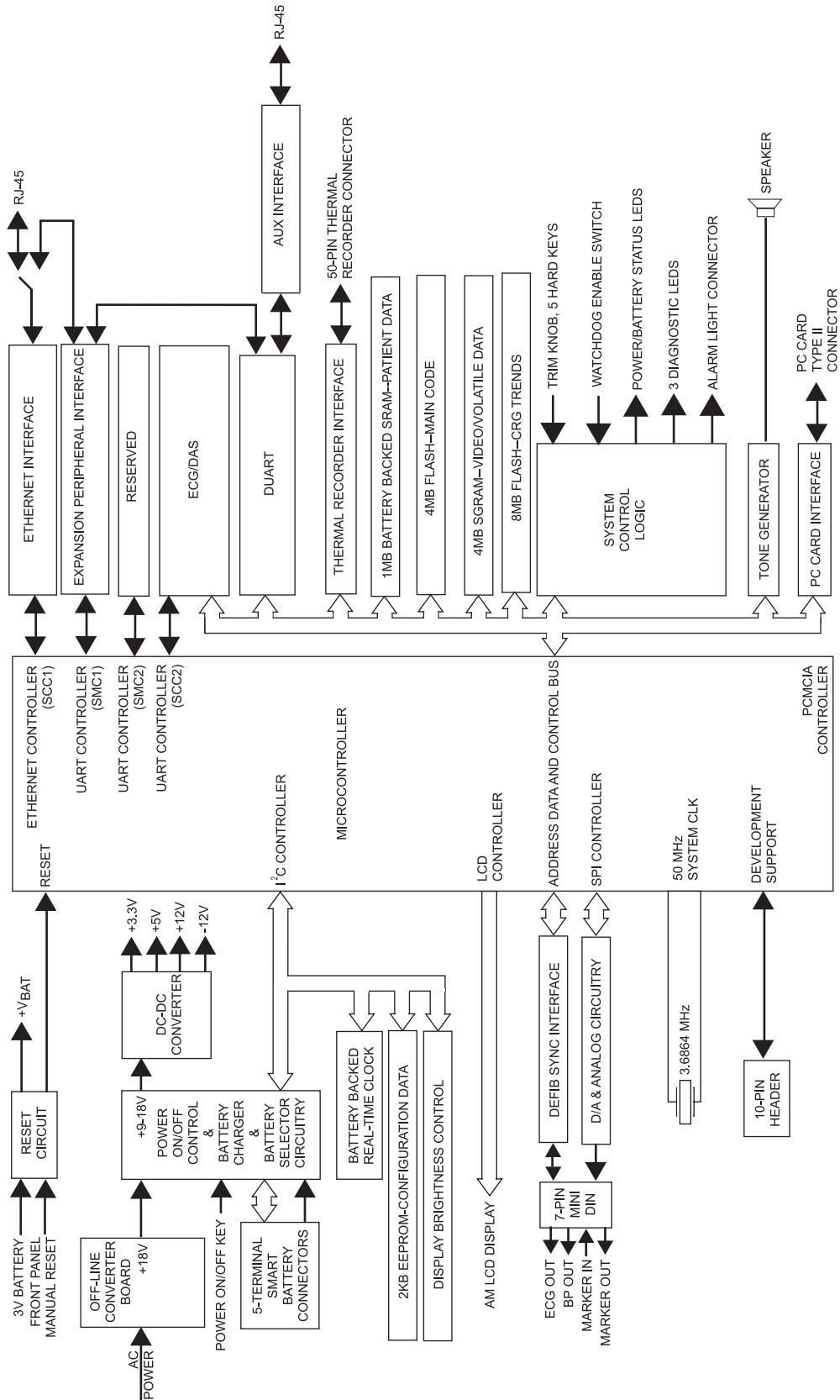



## Main Microcontroller

The microcontroller contains two processors:

- a true internal and external 32-bit CPU core, and
- a communications processor module (CPM).

The CPM contains an 8 Kb dual port RAM to communicate with the CPU core, and once configured communicates with external devices with minimum CPU intervention. External logic is reduced by the internal memory controllers and a system interface unit which provides a clock synthesizer and timers used in this design. Writer communications is supported by direct memory access and processing performance is enhanced by 4-kilobyte instruction and data caches.

<b>Microcontroller Feature</b>	<b>Dash Function</b>
Serial Communications Controller 1	Unity Network
Serial Communications Controller 2	DAS communication
Serial Management Controller 1	Peripheral expansion communication
Serial Management Controller 2	Reserved
Interprocessor-Integrated Controller	<ul style="list-style-type: none"> <li>• Batteries, battery charger,</li> <li>• Real-time clock,</li> <li>• EEPROM,</li> <li>• digital potentiometer for display brightness control</li> </ul>
Serial Peripheral Interface	DAC for ECG and BP analog outputs; ASIC configuration
User Programmable Machine A	Memory controller for synchronous graphics RAM
User Programmable Machine B	Memory controller for synchronous flash
General-Purpose Chip-Select Machine	Memory and peripheral device control
LCD Controller	Color display
PC Card Controller	Future use
DMA	Writer communication
System Phase-Locked Loop (SPLL)	Generation of system clock from crystal oscillator

Microprocessor  
Supervisory Circuit,  
Microcontroller Internal  
Watchdog Timer

The microprocessor supervisory circuit provides reliable operation of the main processor board. This circuit monitors the +3.3 V power supply and asserts a 140 mS active low reset pulse when the power supply voltage is below +3.0 V during power-up and power-down conditions. A 3 V, 0.5 A hour lithium battery is used to preserve the contents of two SRAM devices and a real-time clock (RTC) when VCC is below the reset threshold.

System Control Logic

The system ASIC contains all of the system control logic for the Processor/Power Management PCB. Such functions include address decoding, peripheral read and write control strobes, smart battery control logic, display control, multiple I/O ports, and front panel key switch debouncing.

Memory

Eight Mb of non-volatile memory are provided to support the boot code and expansion memory such as high resolution graphic trends data storage. The 512 Kb boot block is write protected.

Four Mb of non-volatile memory are provided to support the main software application code.

Four Mbytes of volatile memory are provided by the synchronous graphics RAM. This memory is used for stack, variable storage, dynamically allocated memory and video data storage.

One Mb of battery-backed SRAM supports storage of 24 hours of 1-minute resolution patient trends, an error log containing 50 input errors, and 50 output errors and storage for the CPM buffers.

The monitor configuration data such as Internet and Ethernet addresses, unit name and bed number are maintained in the 2 Kb EEPROM. The serial device resides on the I<sup>2</sup>C bus.

Real-Time Clock

The real-time clock incorporates an on-board quartz crystal. This feature simplifies the design and eliminates adjustments. The time of day is maintained to an accuracy of 1 second in 10 hours. The RTC device is one of the devices on the I<sup>2</sup>C bus.

Audio Subsystem

Audio tones are generated using a tone generator, an audio amplifier, and an 8Ω, 2.5-in. speaker. The tone generator has built in D/A converters and a mixer to generate the dual frequency tones. Frequencies ranging from 150 Hz to 2800 Hz are produced.

Video Subsystem

The microprocessor contains a video controller that supports real-time and non-real-time waveform drawing, menu drawing, and parameter display.

Display brightness is controlled by a 50 kΩ digital potentiometer. The potentiometer is interfaced to the brightness control input of an inverter.

Analog Outputs	Two analog output channels support ECG and BP. The pace pulse is generated on the main processor board and inserted into the analog out ECG signal. The digital-to-analog conversion for both ECG and blood pressure output signals are performed on the main processing board via a two channel 12-bit serial DAC. Cal data is stored on the processor/power management PCB.
Defib Sync	The QRS complex of ECG data acquired from the DAS generates the marker-out signal. A software selectable pulse width and pulse amplitude is provided in the Boot Loader Menu.
Optional Thermal Printer	<p>The thermal printer includes complete control of the print head to print the desired waveforms and text as well as monitor power consumption. The host processor on the main processing board has direct communication via an 8-bit data bus to the processor residing within the thermal recorder.</p> <p>The +9-18 V power supplied to the writer is heavily filtered to provide the storage capability to smooth power surges and transients caused by abnormal thermal printing. Such printing may occur if the monitor is subjected to ESU noise. In addition, a writer current limiting circuit restricts the current to the writer to 2.5 A. If this current limit is exceeded, the circuit faults and requires the current limiting circuit to reset through a microprocessor port.</p>
Optional Alarm Light	An alarm light indicating two levels of visual alarms resides in the handle of the Dash 3000 monitor and in the display bezel of the Dash 4000. Red and yellow alarm lights illuminate by addressing an ASIC output port. The Dash 3000 alarm light interfaces to the Processor/Power Management PCB via the 40-pin writer interface. The Dash 4000 alarm light interfaces to the Processor/Power Management PCB via the 100-pin DAS/Display /Keyboard interface.
PC Card	The main processor contains a PC Card controller, which complies with the PCMCIA standard. One 68-pin fully compliant Type II PC Card slot is supported in this design for RF LAN.
Peripheral Expansion Interface	A 20-pin peripheral expansion interface is provided to support future use. An active low peripheral present signal may be polled by software to identify when a peripheral is attached to the monitor. Asynchronous, AUX, and a switched Ethernet serial communication channels are supported as well as switched +9-18 V and +5 V power.

## DAS Communication

The microprocessor communicates with the DAS processor using the second serial communication controller (SCC) of the communication processor module (CPM). This asynchronous communication channel operates at TTL levels and is optically isolated within the DAS.

## Unity Network Communication

The microprocessor provides an Ethernet controller, which is implemented on SCC1 in order to benefit from the additional buffer descriptors compared to SCC2. Ethernet packets are stored in SRAM buffers and are transmitted and received by the 10BASE-T transceiver. The Ethernet clocks are generated from a 20 MHz crystal oscillator circuit and the transceiver. The transceiver also provides a visual indication in the form of four LEDs to identify packet transmit, receive, collision, and link integrity. The status of received data is indicated by the link integrity signal, which is used by the microprocessor to determine if the monitor is connected to the Unity Network.

An isolation transformer provides basic insulation to the twisted pair interface required to meet the ANSI/IEEE 802.3 standard (Ethernet). Isolation is required because during transport the power cord with the ground conductor is not available to provide a path for a fault condition. An 8-pin RJ-45 connector containing two isolated, differential pairs is provided to connect the monitor to a network hub.

**NOTE:** Power is not provided in the twisted pair interface as in the attachment user interface (AUI) of other monitoring products.

## Ethernet Priority

Ethernet communications are prioritized in the following order.

1. Top priority is the Peripheral Expansion interface
2. Next priority is the Hardwired Ethernet connection at the back of the Dash monitor.
3. Lowest priority is the optional Wireless LAN.

If non of the above exist, then the monitor is a stand-alone monitor.

## Async Communication

Two asynchronous communication ports comply with the GEMMS AutoPort protocol and are provided through an 8-pin RJ-45 connector and the 20-pin peripheral interface described in the next section.

## Debug Monitor and Diagnostic LEDs

An integrated debugger operating in the debug mode within the main processor provides basic emulator-like features such as modification of register and memory locations and setting of breakpoints. The connector required for this serial communication is a dual row 10-pin header. This connector is located within the monitor and is not intended for field service use. Tracing of instructions and logic analysis is provided by an adapter board that connects to a socket installed on the main processor board instead of the microprocessor.

Three diagnostic LEDs located along the front edge of the board are provided for general purpose use and are under software control. The LEDs interface directly to port A of the microprocessor. A flashing green LED indicates normal monitoring operation.

## Main DC-DC Converter Section

The main DC-DC converter consists of two independent synchronous rectifier buck regulators with one common controller.

The monitor uses a “point of use” power conversion architecture with +9-18 V being the main power distribution bus.

Four voltage outputs are developed on the processor/power management PCB:

- +3.3 V,
- +5 V,
- -12 V, and
- -12 V.

Each one of the four outputs are individually current limit protected against overload and short circuit.

## Battery Subsystem

Battery charging and control is accomplished on the Processor/Power Management PCB.

The Molicel ME201 is an example of a smart battery. The key features of this off-the-shelf battery are listed below. Additional features of a smart battery include on-pack fuel gauge and standard battery sizes and interconnect.

<b>Feature</b>	<b>ME201 Li Ion Battery</b>
Cells	9 x 4/3 A
Nominal Voltage	11.1 V
Capacity	3.9 Ah
Energy	40 Wh
Weight	38 0g

## Optional Thermal Printer

The monitor uses the same 50-mm thermal printer module that is used in the PRN 50 stand-alone printer. It prints up to four waveforms at chart speeds ranging from 0.1 to 50 mm/s. The printer software is loaded independently from the monitor's software.

In the monitor, the printer module limits its current consumption to stay within its allocated system power budget.

## Speaker

The speaker is used for audible notification of alarms.

## Handle Subassembly

The handle serves multiple purposes in the monitor. The modular design enables the user to add adapters for specialized applications.

The Dash 3000 handle houses the optional alarm light. This light is visible for 360° surrounding the monitor. The light is intended for applications when the audible notification is not useful or effective, such as noisy environments (e.g., emergency vehicles) or quiet environments (e.g., neonatal care areas). The alarm light indicates two levels of visual alarms:

- Crisis alarms (red LED) and
- Warning alarms (amber LED).

The Dash 3000/4000 handle also houses the two RF LAN antennas required for the optional RF LAN subsystem.

## Interfaces

### Ethernet

The Ethernet RJ-45 connector provides a hardware connection to the Unity Network. The monitor has a built-in transceiver for twisted-pair wire. Basic insulation (1500 VAC) isolates the monitor from networked devices.

### AUX

The AUX RJ-45 connector provides an asynchronous communication connection to devices within the bedside care area. Basic insulation (1500 VAC) isolates the monitor from other devices.

### Defib Sync

The Defib Sync connector provides signals needed to perform synchronized cardioversion with a defibrillator. The Marker Out signal is a pulse with selectable amplitude and width that coincides with the patient's ECG R-wave. The Marker In signal is returned to the monitor by the defibrillator. The Marker In signal causes the monitor to insert a defib marker in the displayed ECG waveform.

This connector also provides two analog signals: ECG and invasive pressure. The monitor provides the top displayed ECG signal with reconstructed pace pulses. You can use this signal to trigger a defibrillator or intra-aortic balloon pump. BP1 produces the pressure signal and is intended for triggering an intra-aortic balloon pump.

### Peripheral Expansion

A port is provided for expansion. Asynchronous communication, Ethernet (shared with the Ethernet RJ-45 connector), 9-18 V power, 5 V power, and discrete I/O signals are provided in the interface. The expansion connector pairs with the AC mains power inlet to supply power to the monitor through a peripheral device.

## Setup and Configuration

Program Code Storage	<p>Executable program code for the main processor, DAS processor, and thermal printer are stored in non-volatile programmable memory. Program code can be changed via the AUX port using the PC-based TCCM Update software utility or via the Unity Network (Ethernet port) from a file server supporting the Xfiles protocol.</p> <p>To display the revision of the currently stored code, access the submenu of the main application's Monitor Setup menu.</p>
Monitor Settings	<p>The Processor/Power Management PCB stores default monitor settings in non-volatile memory. The user must restore the original settings if replacing the board.</p>
Patient Data Storage	<p>Static RAM backed up by a lithium battery soldered onto the Processor/Power Management PCB stores patient data.</p>
Time and Date	<p>The monitor maintains time and date for at least five years. Time is accurate to within one second in ten hours. The clock is synchronized with a time master on the Unity Network.</p>
Calibration Data	<p>Calibration factors for NBP and CO<sub>2</sub> are stored in non-volatile memory on the DAS board.</p> <p>Calibration factors for the analog output signals are stored in non-volatile memory on the Processor/Power Management PCB.</p>
Error Log	<p>50 input errors and 50 output errors are retained in static RAM backed up by a lithium battery soldered onto the processor/power management PCB. Contents are retained for at least five years, provided that you exercise caution when you handle the board to prevent inadvertently discharging the battery (e.g. when you ship the board for problem diagnosis).</p>

# Electrical Diagram

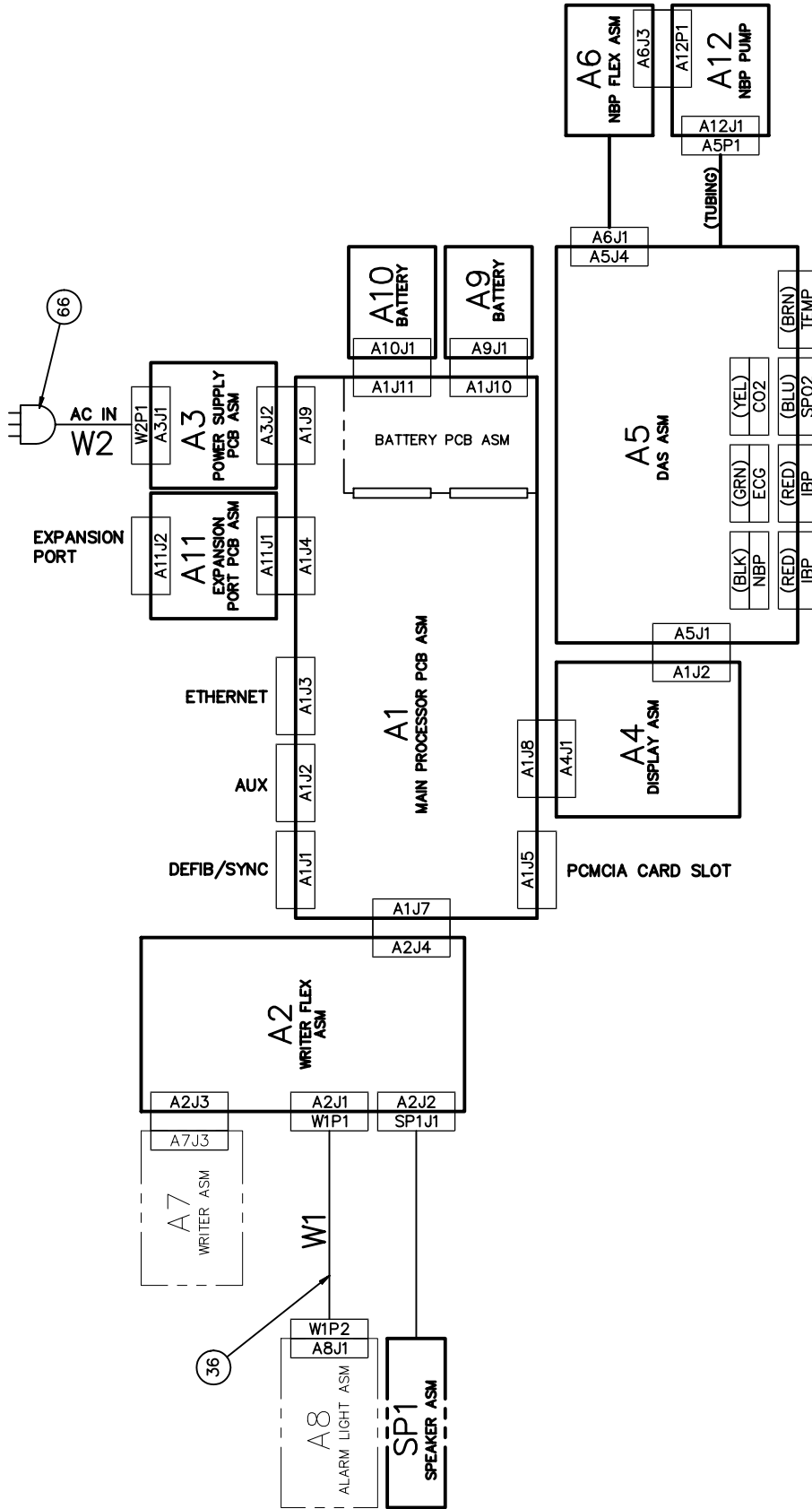



# Dash 3000 Exploded Views

# PN 420000-xxx

Sheet 1 of 3

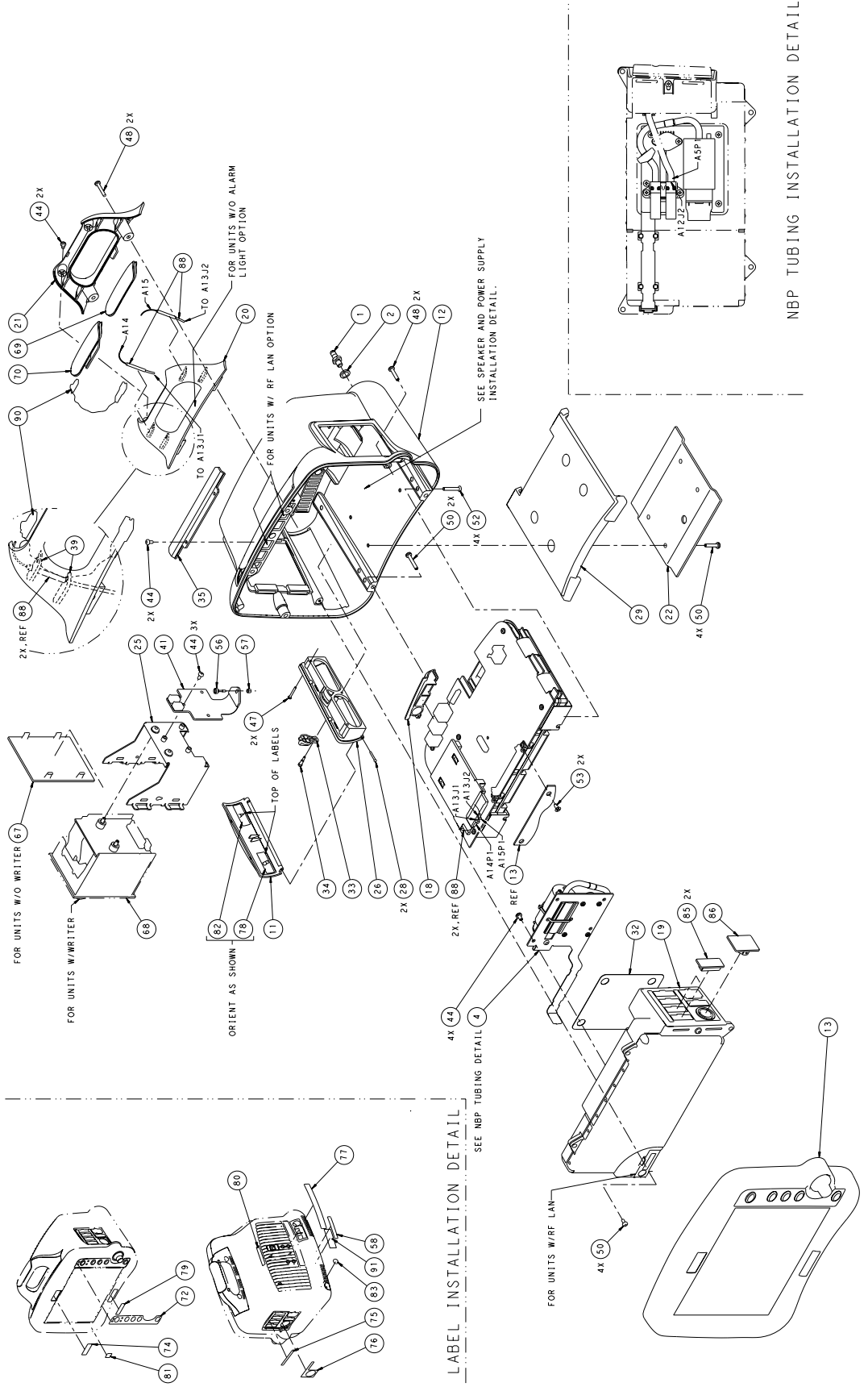



Sheet 3 of 3

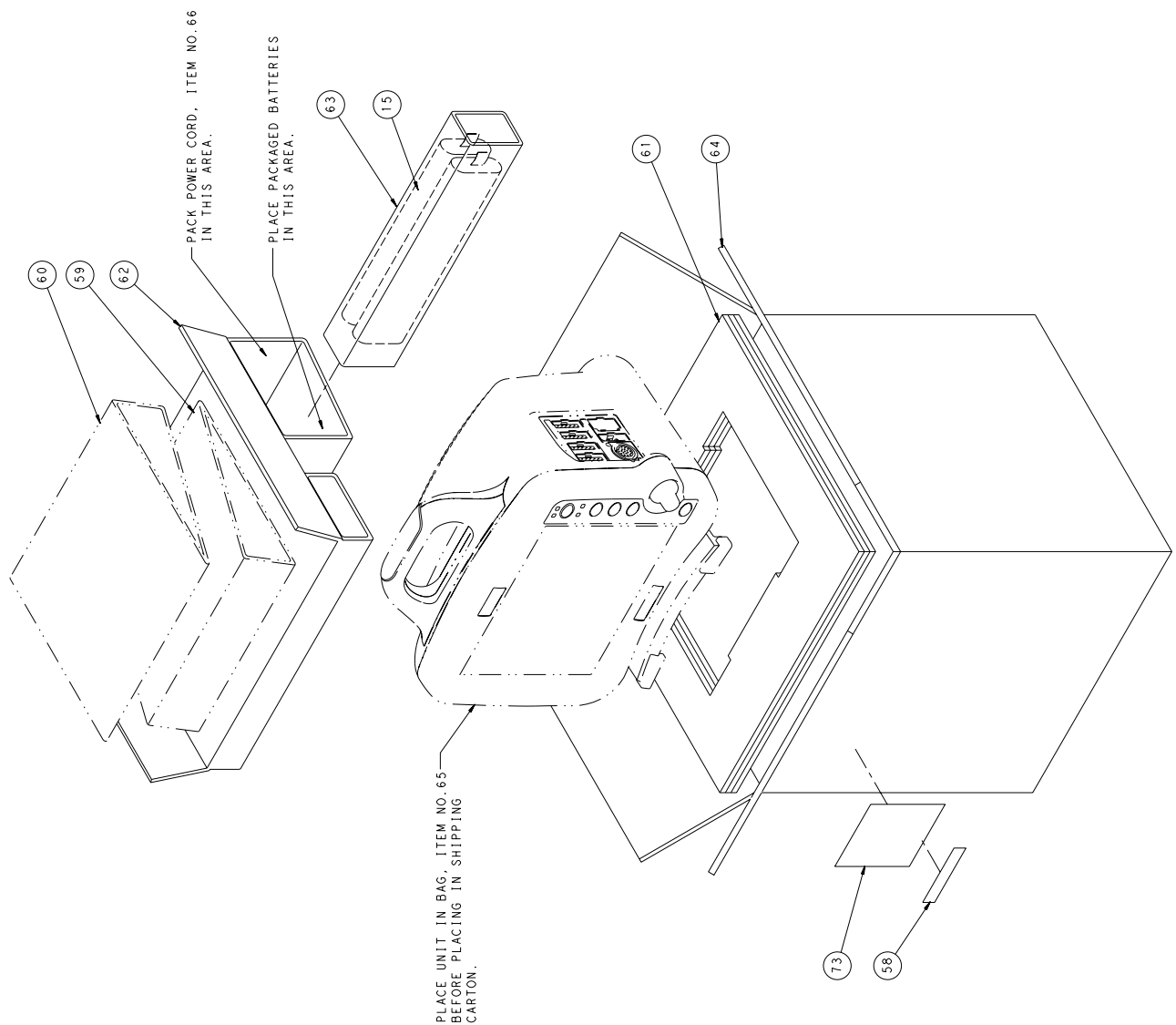

## Dash 3000 Parts List

PN 420000-007

Find Number	Item Number	Item Description	Reference Designator	Qty
1	400040-001	PLUG MC EQUIPOTENTIAL		1
2	400041-001	WASHER LOCK SERRATED F/M-6		1
4	2000976-001	ASSY DASH NBP	A12	1
6	411508-007	SCREW METRIC PH SST M2X12 W/COAT		4
7	411509-001	NUT HEX METRIC M2		4
8	417436-001	BATTERY HOUSING TOP		1
9	417436-002	BATTERY HOUSING BOTTOM		1
11	419027-001	BATTERY DOOR DASH		1
12	419030-003	HOUSING REAR DASH 3000 MACH		1
13	419031-003	ASSY DASH 3000 LCD DISPLAY	A4	1
16	419477-001	POWER SUPPLY ASM DASH 3000	A3	1
17	419483-001	SPEAKER ASSEMBLY DASH	SP1	1
18	419577-001	PANEL CONNECTOR ISOLATOR DASH		1
19	419723-001	ASSY DAS DASH 3000	A5	1
20	419998-001	HANDLE HALF FRONT DASH		1
21	419998-002	HANDLE HALF REAR DASH		1
22	420001-001	PLATE MOUNT GCX DASH		1
23	420036-001	MECH NON-EJECT PCMICA 5MM SO		1
24	420037-001	HDR 3.3V PCMCIA SING 5MM		1
25	421263-003	BRKT DASH WRITER MTG		1
26	421717-001	BEZEL DASH BATTERY		1
27	421816-001	HOUSING, EXPANSION CONNECTOR		1
28	421863-001	PIN DASH BATTERY DOOR HINGE		2
29	421877-001	FOOT PAD DASH 3000		1
30	421952-001	SHIELD DASH CPU		1
31	421955-001	INSULATOR DASH CPU		1
32	421955-003	INSULATOR DASH NBP PCB		1
33	422102-001	LATCH BATTERY DASH 3000		1
34	422134-001	SCREW SHLDR M2 X 12 SLOTTED		1
35	422387-001	BRACKET DASH HANDLE MNT		1
36	422647-001	CBL ASM DASH ALARM LIGHT	W1	1
37	422679-001	BRKT DASH FLEX MOUNT		2
41	801536-001	FLEX ASM DASH 3000 THERMAL RECORDER	A2	1
42	801424-002	PCB DASH 3000/4000 PROCESSOR PWR/MGMT	A1	1
43	801550-001	PCB DASH 3000 EXPANSION PT	A11	1
44	2000540-001	SCR MACH PNHD M3X6LG SST W/THD LOCK		20
46	2000540-004	SCR MACH PNHD M3X20LG SST W/THD LOCK		3
47	2000541-001	SCR MACH PNHD M2X16LG SST W/THD LOCK		2
48	2000543-001	SCR MACH PNHD M4X25LG SST W/THD LOCK		4

Find Number	Item Number	Item Description	Reference Designator	Qty
49	2000546-001	SCR MACH PNHD M4X6LG SST W/THD LOCK		4
50	2000546-002	SCR MACH PNHD M4X16LG SST W/THD LOCK		10
51	2000546-004	SCR MACH PNHD M4X10LG SST THD LOCK		2
52	2000551-001	SCR MACH FLHD M4X25LG SST W/THD LOCK		4
53	2001075-001	SCR MACH FLHD M3X6LG SS W/THD LK		2
56	422826-001	SCREW CAPTIVE PANEL M3X.5X14.5		1
57	422827-001	STANDOFF FEMALE 6MM RND 5MM LG		1
58	404525-006	LABEL BLANK 2.6IN X.4IN		2
59	421298-002	CODE PRN50 MAIN V2A		1
60	419743-002	THERMAL PRINTER 50MM CS2		1
87	2002329-002	PLATE PCMCIA CARD RETAINING		1
88	421750-001	ANT 2.4GHZ 1/2 WAVE INT		2
89	2003108-001	CARD PCMCIA 100MW SPECTRUM24 W/LAN ADPTR		1
91	404525-008	LABEL BLANK 1.2IN X .6IN		1
92	404525-101	LABEL BLANK 2.00 X .75		1
	422480-002	LABEL KIT DASH 3000 ENG		1
	422480-003	LABEL KIT DASH 3000 GER		1
	422480-004	LABEL KIT DASH 3000 FRE		1
	422480-005	LABEL KIT DASH 3000 SWE		1
	422480-006	LABEL KIT DASH 3000 SPA		1
	422480-007	LABEL KIT DASH 3000 ITA		1
	422480-008	LABEL KIT DASH 3000 DUT		1
	422480-009	LABEL KIT DASH 3000 DAN		1
	422480-010	LABEL KIT DASH 3000 NOR		1
	422480-011	LABEL KIT DASH 3000 JAP		1
	422480-012	LABEL KIT DASH 3000 POR		1
	422480-012	LABEL KIT DASH 3000 CHI		1
	422480-012	LABEL KIT DASH 3000 HUN		1



# Dash 3000 Display Bezel Parts List      PN 419031-001

Find Number	Item Number	Item Description	Reference Designator	Qty
1	2000516-001	CLIP ELECTRICAL GROUNDING		1
2	2000521-001	CLIP ELECTRICAL GROUNDING		.25
3	2000540-001	SCR MACH PNHD M3X6LG SST W/THD LOCK		4
4	2000588-001	SPACER HEX M2.5 X 7.2 LG		4
5	2000618-001	SCR MACH PNHD M2.5X16LG SST		4
6	2000619-001	NUT HEX M2.5 SST		4
7	2000905-001	SCR TAPPING TC SST #4X.31 HI-LO		5
8	403901-001	NUT HEX M3 GR10		2
9	409839-001	WASHER,LOCK,EXTT,M2.5		4
10	414622-001	TRIM KNOB ONE INCH		1
11	418633-001	BEZEL MONITOR		1
12	418957-001	KEYPAD ASSEMBLY	A3	1
13	418961-001	FILTER DISPLAY		1
14	419214-001	ISOLATOR DASH LCD DISPLAY		1
15	419353-001	BRACKET ISOLATOR		1
16	419379-001	DISPLAY LCD DASH 21CM	A4	1

# Dash 3000 Display Bezel Assembly PN 419031-003

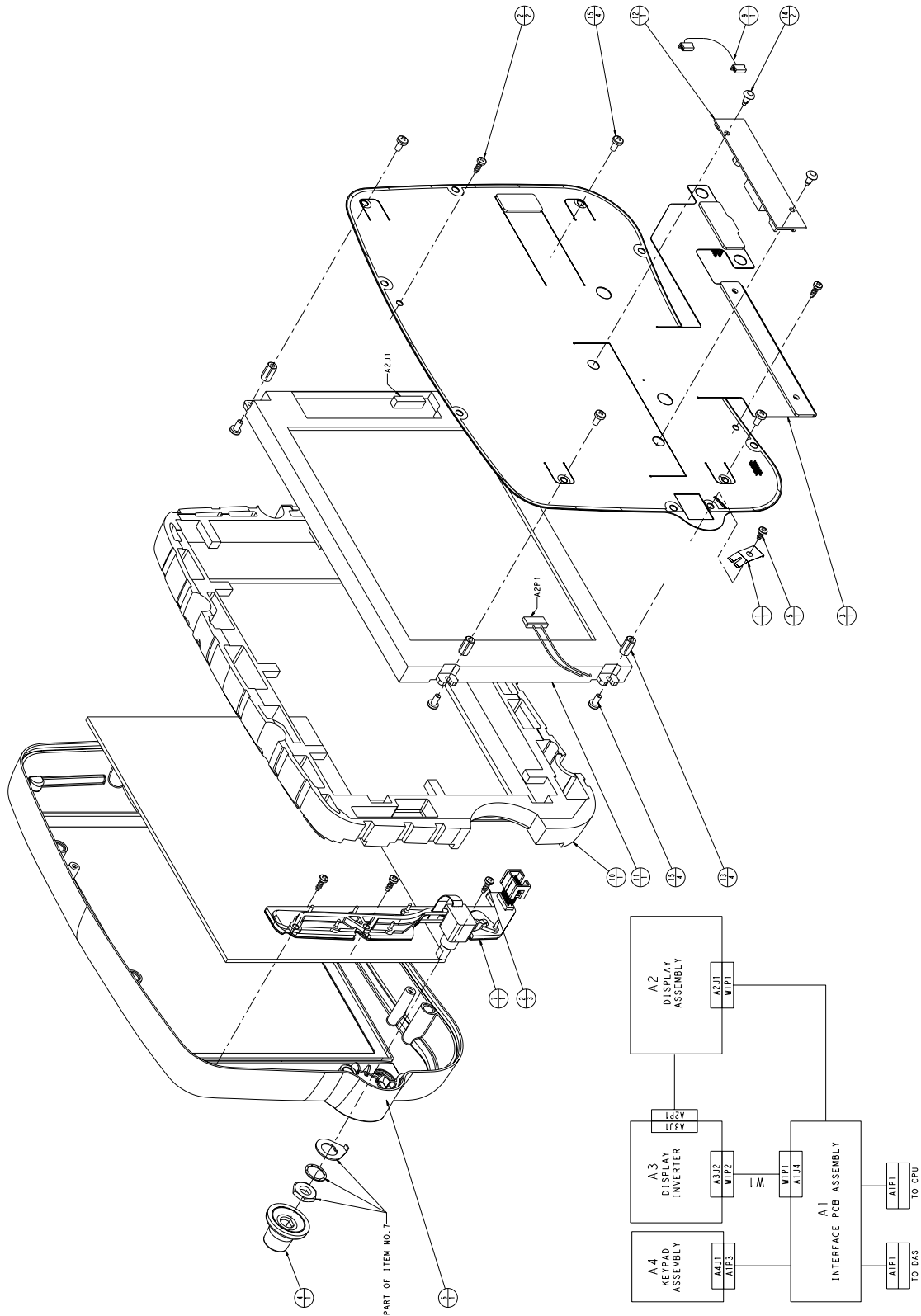



# Dash 3000 Display Bezel Part List PN 419031-003

Find Number	Item Number	Item Description	Reference Designator	Qty
1	2000516-001	CLIP ELECTRICAL GROUNDING		1
2	2000905-001	SCR TAPPING TC SST #4X.31 HI-LO		5
3	2002393-001	FLEX DASH 3000 DISPLAY/SHIELD		1
4	414622-001	TRIM KNOB ONE INCH		1
5	415870-001	SCREW 4-24X.25LG PH HI-LO TH		1
6	418633-001	BEZEL MONITOR		1
7	418957-002	ASSY DASH 3000 KEYPAD		1
8	418961-001	FILTER DISPLAY		1
9	419557-001	CA ASSY DSPLY INVERTER DASH		1
10	419214-001	ISOLATOR DASH LCD DISPLAY		1
11	419379-001	DISPLAY LCD DASH 21CM		1
12	422429-001	INVERTER LCD BACKLIGHT LS380		1
13	2004262-001	SPACER HEX FF M3 5MM HEX X 10		4
14	422585-002	RIVET SNAP 3X5.5MM NYLON BLK		2
15	2000540-001	SCR MACH PNHD M3X6LG SST W/THD LOCK		8

# Dash 4000 Exploded Views

# PN 2004323-xxx

Sheet 1 of 2

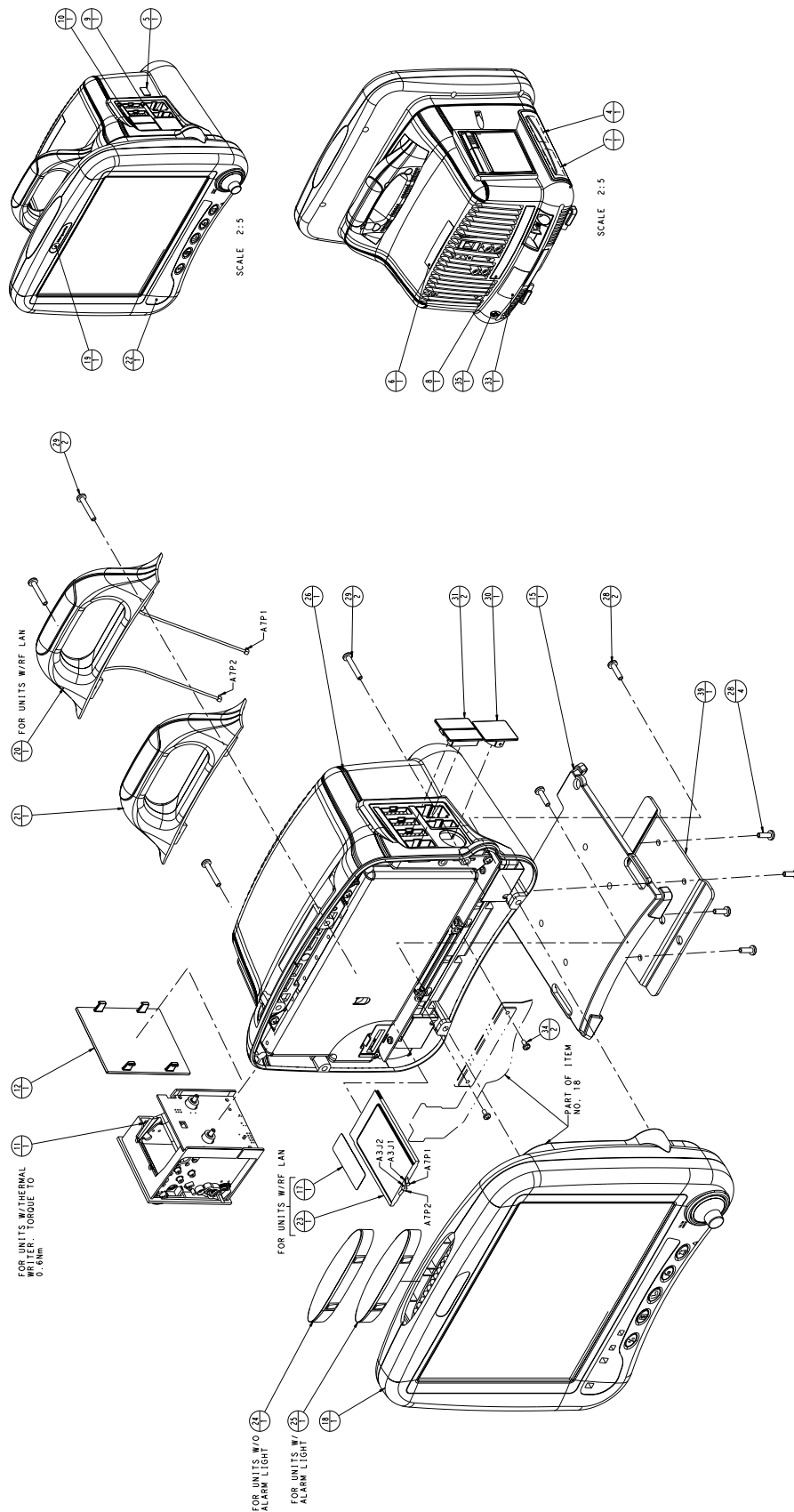

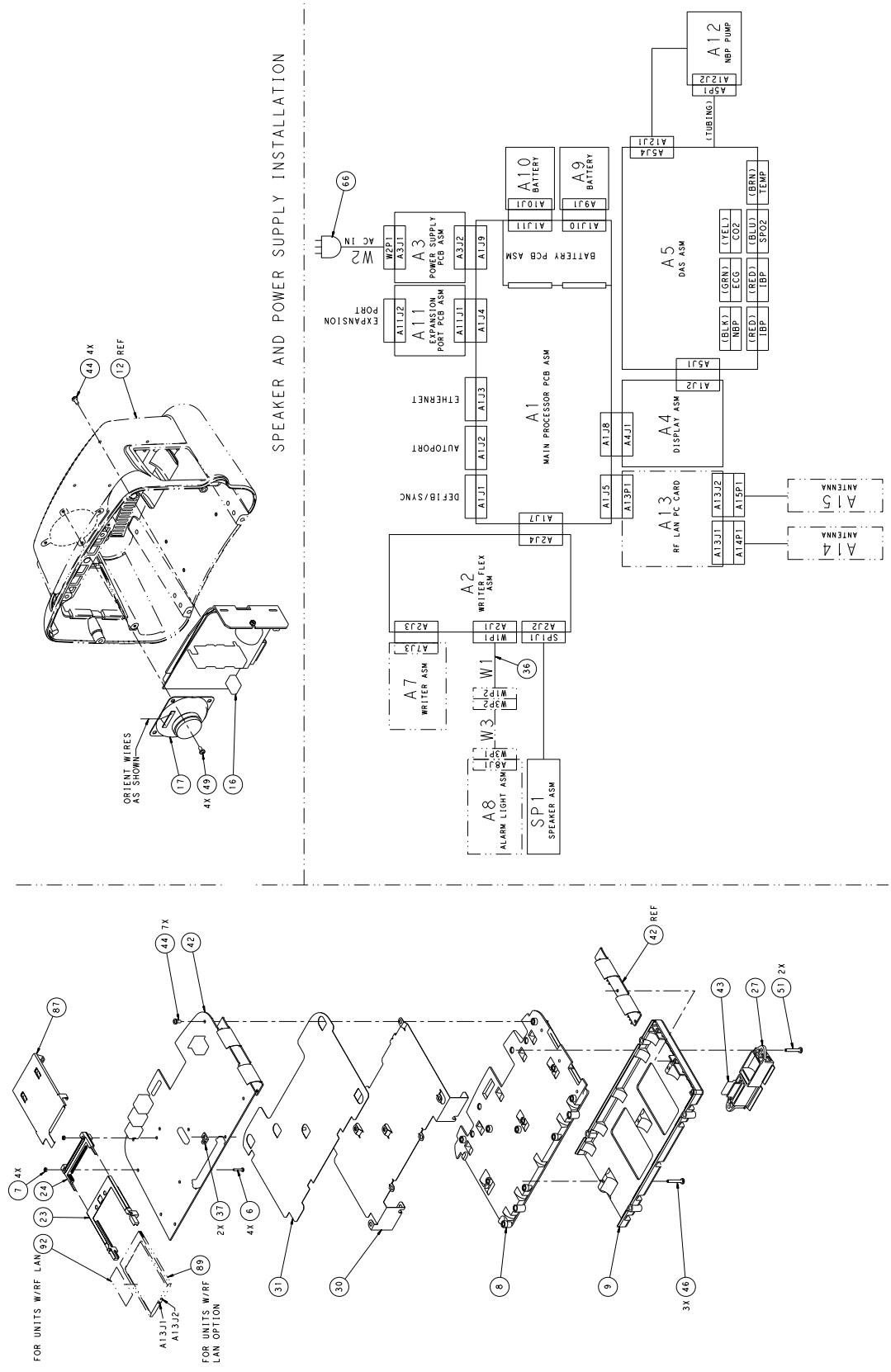

## Dash 4000 Parts List

PN 2004323-001

Find Number	Item Number	Item Description	Reference Designator	Qty
1	9402 SAMPLE-046	PAPER SAMPLE NO GRD 50MMX100FR		1
2	80274-103	CORD PWR 125V 6FT RA TO5	W1	1
3	422774-018	PACKAGING BOX 13.10 X 12 X 13.05 DEEP		1
4	422494-001	LBL DASH 3000 BATTERY B ENG		0
5	422487-001	LABEL 12SL .007 POLYCARBONATE		0
6	422482-001	LABEL PRESCRIPTION DEVICE .007		0
7	422329-001	LBL DASH 3000 BATTERY A ENG		0
8	422324-001	LABEL DASH CONN/UL/CE		0
9	422323-001	LBL DASH 3000 CONN CO2		0
10	422322-001	LBL DASH 3000 CONN BP		0
11	419743-002	THERMAL PRINTER 50MM CS2	A4	1
12	419378-001	COVER SIDE DASH WO/WRIER		1
13	419068-001	BATT RCHGBL MOLICELL 11.1V	A5,A6	2
14	404525-006	LABEL BLANK 2.6IN X.4IN		1
15	421877-001	FOOT PAD DASH 3000		1
16	2004586-001	PACKAGING INSERT DASH 4000 TOP		1
17	404525-101	LABEL BLANK 2.00 X .75		1
18	2004272-001	ASSY DASH 4000 DISPLAY	A2	1
19	2004252-001	LABEL DASH 4000 PRODUCT MARK		0
20	2004095-003	ASSY DASH HANDLE W/O LIGHT W/ANTENNA	A7	1
21	2004095-001	ASSY DASH HANDLE W/O LIGHT W/O ANTENNA		0
22	2004009-001	LABEL DASH 4000 FRONT PANEL ENG		0
23	2003108-001	CARD PCMCIA 100MW SPECTRUM24 W/LAN ADPTR	A3	1
24	2002218-002	LENSE DASH 4000 OPAQUE		1
25	2002218-001	LENSE DASH 4000 ALARM LIGHT		1
26	2001875-001	ASSY DASH 3000/4000 REAR	A1	1
27	2004586-004	INSERT PACKAGING DASH BATTERY		1
28	2000546-002	SCR MACH PNHD M4X16LG SST W/THD LOCK		6
29	2000543-001	SCR MACH PNHD M4X25LG SST W/THD LOCK		4
30	2000462-002	COVER DASH C02 CONN		1
31	2000462-001	COVER DASH PATIENT CONNECTOR		2
32	422159-093	LABEL CARTON DASH 4000		1
33	404525-001	LABEL BLANK 2 X 3/4		1
34	2000540-001	SCR MACH PNHD M3X6LG SST W/THD LOCK		2
35	422733-001	LBL EQUIPOTENTIALITY .007		0
36	2004586-003	INSERT PACKAGING FOAM DASH 4000		1
37	2000966-047	CD SVCE DASH 3000/4000 V2 ENG		1
38	2000966-034	MNL OPR DASH 3000/4000 V2 ENG		1

<b>Find Number</b>	<b>Item Number</b>	<b>Item Description</b>	<b>Reference Designator</b>	<b>Qty</b>
39	420001-001	PLATE MOUNT GCX DASH		1
40	2004586-002	PACKAGING INSERT DASH 4000 BASE		1
41	99014-001	BAG INTISTATIC POLY 18 X 20		1
	2004298-001	LABEL KIT DASH 4000 ENG		1
	2004298-002	LABEL KIT DASH 4000 GER		1
	2004298-003	LABEL KIT DASH 4000 FRE		1
	2004298-004	LABEL KIT DASH 4000 SWE		1
	2004298-005	LABEL KIT DASH 4000 SPA		1
	2004298-006	LABEL KIT DASH 4000 ITA		1
	2004298-007	LABEL KIT DASH 4000 DUT		1
	2004298-008	LABEL KIT DASH 4000 DAN		1
	2004298-009	LABEL KIT DASH 4000 NOR		1
	2004298-010	LABEL KIT DASH 4000 JAP		1
	2004298-011	LABEL KIT DASH 4000 POR		1
	2004298-012	LABEL KIT DASH 4000 RUS		1
	2004298-013	LABEL KIT DASH 4000 CHI		1
	2004298-014	LABEL KIT DASH 4000 HUN		1

# Dash 4000 Display Assembly

# PN 2004272-001

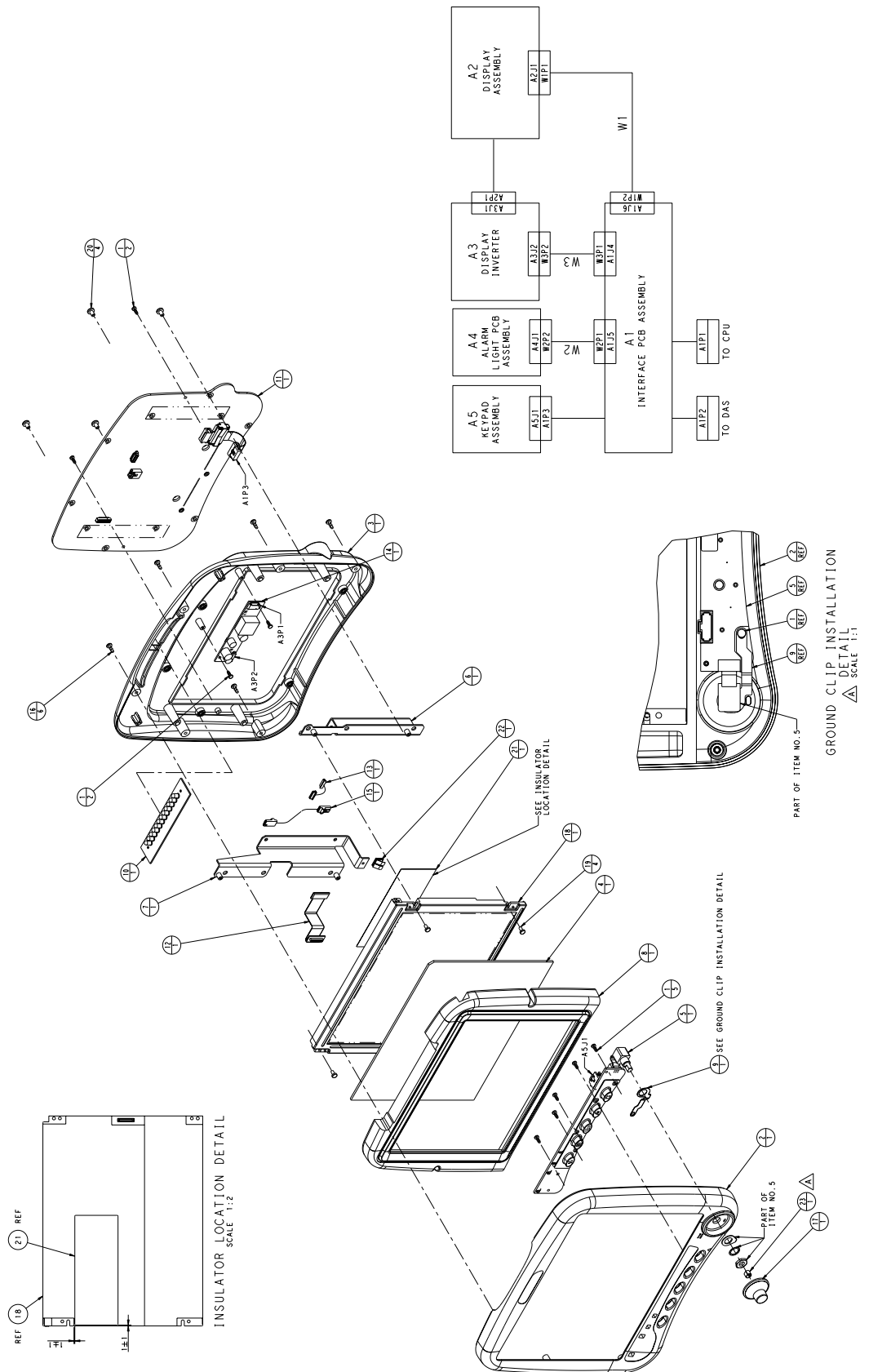

# Dash 4000 Display Bezel Parts List PN 2004272-001

Find Number	Item Number	Item Description	Reference Designator	Qty
1	2000905-001	SCR TAPPING TC SST #4X.31 HI-LO		9
2	2002161-001	BEZEL DASH 4000 FRONT		1
3	2002162-001	BEZEL DASH 4000 TRANSITION		1
4	2002210-001	FILTER OPT 26MM DISPLAY 1.6THK		1
5	2002220-001	PCB ASSY DASH4000 KEYPAD	A5	1
6	2002272-001	BRACKET DASH 4000 26 DISP MT RT		1
7	2002272-002	BRACKET DASH 4000 26 DISP MT LEFT		1
8	2002563-001	INSERT DASH 4000 DISPLAY		1
9	2003610-001	CLIP DASH 4000 TK GND		1
10	2004229-001	PCB DASH 4000 ALARM LIGHT	A4	1
11	2003768-001	PCB DASH 4000 FRONT PANEL	A1	1
12	2003784-001	PCB FLEX CKT DASH 4000 DISPLAY 31P	W1	1
13	2003791-002	CABLE ASSY DASH 4000 INVERTER	W3	1
14	2004019-001	PWR SPLY CCFL INVERTER VIN8-18V	A3	1
15	2004209-001	CABLE ASSY DASH 4000 ALARM LIGHT	W2	1
16	402440-001	SCREW PH PLASFORM #6-10 X .		6
17	406080-001	TRIM KNOB EAGLE		1
18	416734-002	DSPL LCD 10.5 IN VGA COLOR TFT -31D NEC	A2	1
19	2000540-001	SCR MACH PNHD M3X6LG SST W/THD LOCK		4
20	2000546-001	SCR MACH PNHD M4X6LG SST W/THD LOCK		4
21	404188-003	INSULATION DASH 3000 DISPLAY INVERTER		1
22	2000521-001	CLIP ELECTRICAL GROUNDING		1
23	4556-001	SPRING CLIP D TYPE .250 DIA		1

## Field Replaceable Units (FRU's)

\* Indicates what is needed when ordering FRU from customer service.

### Dash 3000 FRUs

Part Number	Description	Qty	Comments
2000971-002	Processor/Power Management Assembly	1	* Need software revision and installed options
419723-001	DAS Assembly	1	* Need software revision
419477-001	Power Supply	1	
419473-002	2-Inch Writer Assembly	1	* Need software revision
2000976-001	NBP Assembly	1	
2003108-001	RF LAN Card	1	
419031-001	Display Assembly	1	Order labels separately.
419031-003			Use 419031-003 for assemblies with display shield flex circuit, PN 2002393-001.
2000968-001	LCD Display	1	Use 419379-001 for assemblies with display shield flex circuit, PN 2002393-001.
419379-001			
418957-001	Keypad Assembly	1	Use 418957-002 for assemblies with display shield flex circuit, PN 2002393-001.
418957-002			
4222429-001	Backlight Inverter	1	

### Dash 4000 FRUs

Part Number	Description	Qty	Comments
2000971-002	Processor/Power Management Assembly	1	* Need software revision and installed options
419723-001	DAS Assembly	1	* Need software revision
419477-001	Power Supply	1	
419473-002	2-Inch Writer Assembly	1	* Need software revision
2000976-001	NBP Assembly	1	
2003108-001	RF LAN Card	1	
2004272-001	Display Assembly	1	Order labels separately.



ASSEMBLY DRAWINGS: Field Replaceable Units (FRU's)

---

<b>Part Number</b>	<b>Description</b>	<b>Qty</b>	<b>Comments</b>
416734-002	LCD Display	1	Use 419379-001 for assemblies with display shield flex circuit, PN 2002393-001.
2002220-001	Keypad Assembly	1	Use 418957-002 for assemblies with display shield flex circuit, PN 2002393-001.
2004019-001	Backlight Inverter	1	
2004229-001	Alarm Light	1	
2003768-001	Front Panel PCB	1	

# Port Connections

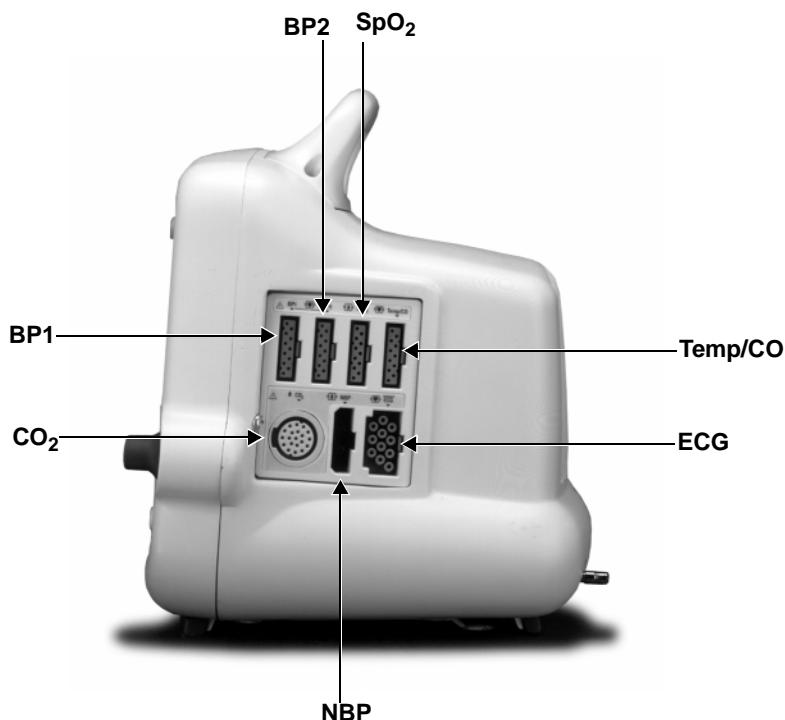

## Invasive Blood Pressure Cable Connector

Two invasive blood pressure channels are provided; each channel uses a separate 11-pin, female connector. The pinout is as follows:

PIN	SIGNAL NAME	I/O	SIGNAL DESCRIPTION	DIAGRAM
1	BP_+VREF	O	BP transducer excitation voltage	
2	BP SIG+	I	BP transducer signal positive (+)	
3	NC	-	No connection	
4	AGND	O	Analog ground	
5	NC	-	No connection	
6	SHIELD	O	BP cable shield	
7	AGRND	O	Analog ground	
8	BP SIG1	I	BP transducer signal negative (-)	
9	NC	-	No connection	
10	BP1_ID	I	BP1 probe identification signal	
11	NC	-	No connection	

## Pulse Oximetry (SpO<sub>2</sub>) Cable Connector

The pulse oximetry function uses an 11-pin, female connector. The pinout is as follows:

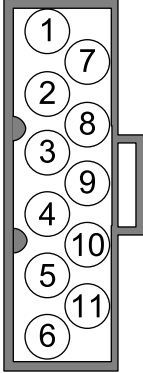
PIN	SIGNAL NAME	I/O	DESCRIPTION	DIAGRAM
1	NELLCOR_RCAL	O	Nellcor probe characteristics ID resistor	
2	IR/RED*	O	Anti-parallel LED drive (low=RED, high=IR)	
3	RED/IR*	O	Anti-parallel LED drive (low=IR, high=RED)	
4	NC	–	Not connected	
5	POX+	I	Photo detector anode	
6	SHIELD	–	Cable shield	
7	NELLCOR_RCAL_RETURN	I	Return for probe characteristics ID resistor	
8	MARQUETTE_PROBE*	I	Marquette probe select	
9	POX–	I	Photo detector cathode	
10	NELLCOR_PROBE*	I	Nellcor probe select	
11	GND	–	Ground reference for pins 8 and 10	

## Temperature/CO Cable Connector

The temperature/CO function uses an 11-pin, female connector. The pinout is as follows:

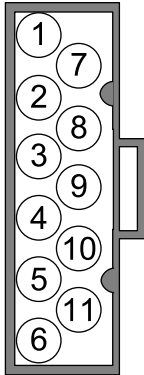
PIN	SIGNAL NAME	I/O	DESCRIPTION	DIAGRAM
1	+0.25V_REF	O	+0.25 V sensor drive voltage	
2	DT/CO_IN1	I	Input from temperature sensor, channel 1	
3	CO_OFFSET	I	CO offset	
4	NC	–	No connection	
5	700*/400_ID	I	Thermistor ID (LOW=YSI 700 Series; HIGH=YSI 400 Series)	
6	SHIELD	–	Cable shield	
7	AGND	–	Analog ground	
8	DT/CO_IN2	I	Input from temperature sensor, channel 2	
9	CO_PROBE_PRESENT	I	CO probe presence identification signal	
10	TEMP_PROBE_PRESENT	I	Temperature probe presence identification signal	
11	DGND	–	Logic ground (reference for pins 5, 9 and 10)	

## Capnostat III (CO<sub>2</sub>) Cable Connector

Connection to the Capnostat III is via the Novamatrix standard 20-pin circular connector. The pinout is as follows:

PIN	SIGNAL NAME	I/O	SIGNAL DESCRIPTION	DIAGRAM
1	SOURCE+	O	Capnostat Infra-red source drive positive (+)	
2	SOURCE-	O	Capnostat Infra-red source drive negative (-)	
3	EE_CS	O	Chip select to 93C46 EEPROM within Capnostat.	
4	CO2_REF_IN	I	CO <sub>2</sub> reference channel signal input from Capnostat which is not affected by the presence of CO <sub>2</sub> .	
5	CASE_HTR	O	DC voltage, generated from a software controlled PWM drive signal, which controls the Capnostat case temperature.	
6	CO2_IN	I	CO <sub>2</sub> data channel signal input from Capnostat which is affected by the presence of CO <sub>2</sub> .	
7	EE_SCLK	O	Serial data clock to 93C46 EEPROM within Capnostat.	
8	HTR_RTN	-	GND return for pins 5 and 16	
9	EE_DATA_OUT	I	Data from 93C46 EEPROM within Capnostat (output from EEPROM).	
10	+5V	-	Logic supply voltage to Capnostat	
11	EE_DATA_IN	O	Data to 93C46 EEPROM within Capnostat (input to EEPROM).	
12	SPAN_SW*	I	Driven low to indicate that the Capnostat has been placed on the REF cell.	
13	SHIELD	-	Termination for both inner and outer shields of the Capnostat cable - is connected to the main DAS floating shield plane and cover.	
14	ZERO_SW*	I	Driven low to indicate that the Capnostat has been placed on the ZERO cell.	
15	CASE_THERM	I	Case thermistor (also used for Capnostat presence detection).	
16	DET_HTR	O	DC voltage, generated from a software controlled PWM drive signal, which controls the Capnostat detector temperature.	
17	DET_THERM	I	Detector thermistor	
18	-12V	-	Negative (-) analog supply voltage to Capnostat	
19	+12V	-	Positive (+) analog supply voltage to Capnostat	
20	AGND	-	Analog GND	

## NBP Connector

A pneumatic connector is used for the patient interface.

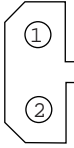
PIN	SIGNAL NAME	I/O	DESCRIPTION	DIAGRAM
1		I	Sensing Side (to pressure sensor)	
2		I	Pressure Side (pump, valves, overpressure sensor)	

## ECG Cable Connector

The ECG/Respiration function uses a recessed, 11-pin, female, ECG connector. The pinout is as follows:

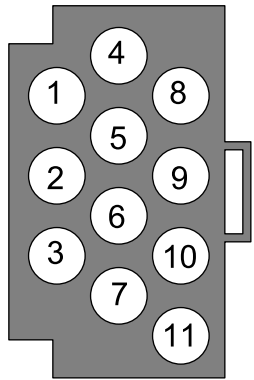
PIN	SIGNAL NAME	I/O	DESCRIPTION	DIAGRAM
1	RA	I	Right arm electrode	
2	V2	I	Chest electrode V2	
3	V3	I	Chest electrode V3	
4	LA	I	Left arm electrode	
5	RL	O	Right leg (reference) electrode	
6	V/V1	I	Chest electrode V1	
7	V4	I	Chest electrode V4	
8	LL	I	Left leg electrode	
9	V6	I	Chest electrode V6	
10	V5	I	Chest electrode V5	
11	SHIELD	-	Cable shield - connected to ECG shield plane and electrostatic cover	

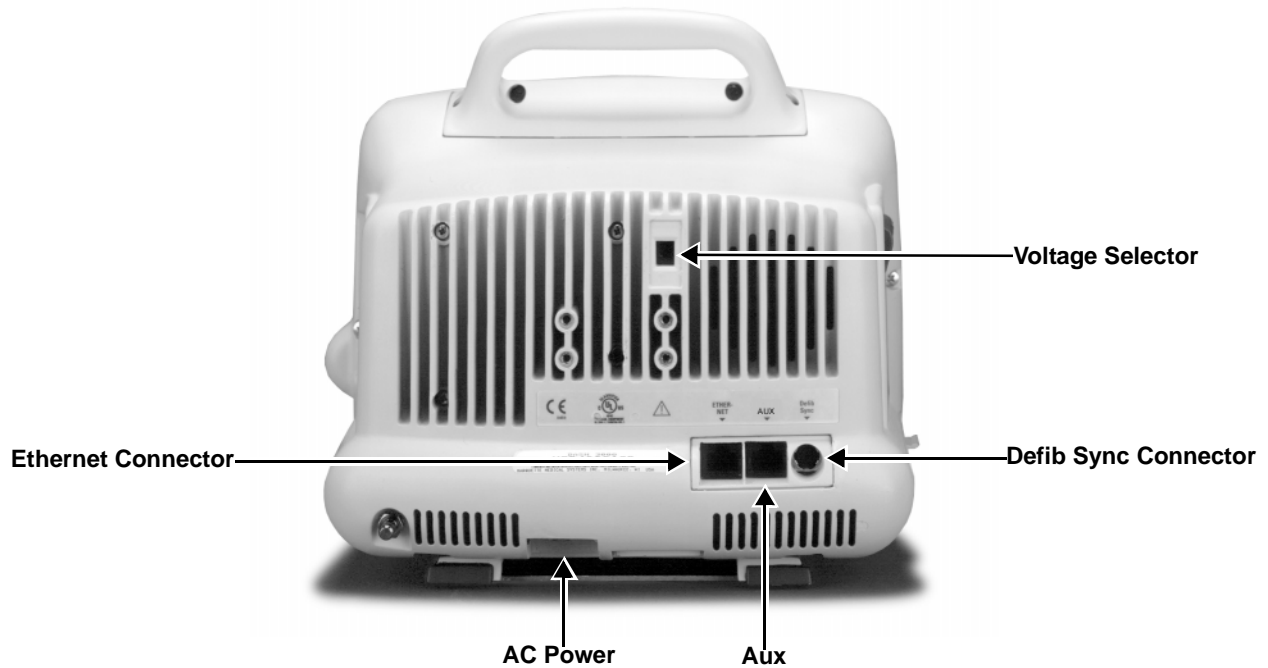

## Input Power Requirements

PIN	SIGNAL NAME	I/O	SIGNAL DESCRIPTION	DIAGRAM
1	NEUTRAL	I	AC Mains Power	
2	LINE	-	Pin Not Inserted	
3	GROUND	-	AC Mains Power	

## Network Interface

An 8-pin RJ-45 connector containing two isolated, differential pairs is provided to connect the monitor to a network hub.

PIN	SIGNAL NAME	I/O	SIGNAL DESCRIPTION	DIAGRAM
1	LAN_TX+	O	LAN transmit +	
2	LAN_TX-	O	LAN transmit -	
3	LAN_RX+	O	LAN receive +	
4	NC	-	No connection	
5	NC	-	No connection	
6	LAN_RX-	O	LAN receive -	
7	NC	-	No connection	
8	NC	-	No connection	

## Auxiliary Communication

Auxiliary communication communicates with peripherals such as a remote control, data logger, or external thermal recorder. The UART channel is only capable of communicating with external devices having the same transmit and receive baud rates. Power available to peripheral devices is current limited to 100 mA.

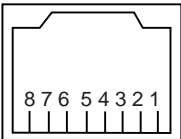
PIN	SIGNAL NAME	I/O	SIGNAL DESCRIPTION	DIAGRAM
1	AUTOPORT_+5V	O	Isolated +5V	
2	SPARE	I	Spare	
3	AUTOPORT_232_RX	I	RS-232 receive signal	
4	AUTOPORT_GND	–	Power return	
5	AUTOPORT_ID	I/O	Device identification signal - host side	
6	AUTOPORT_232_TX	O	RS-232 transmit signal	
7	AUTOPORT_+10V_RTS	O	RS-232 request-to-send signal (remote alarm control signal)	
8	AUTOPORT_+10V_DSR	O	RS-232 data-terminal-ready signal	

## Defib Sync

Analog outputs consisting of ECG waveforms including the pace pulse and the BP out are available through the 7-pin mini-DIN connector. The two analog outputs are calibrated by monitoring the outputs with a precision voltmeter while trimming the offset and gain adjustments with the Trim Knob.

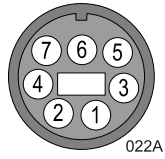
PIN	SIGNAL NAME	I/O	SIGNAL DESCRIPTION	DIAGRAM
1	MARKER_OUT	O	Digital defibrillator output synchronization signal	
2	MARKER_IN	I	Digital defibrillator input signal	
3	GND	–	Common return	
4	GND	–	Common return	
5	RESERVED	–	Reserved	
6	BP/RESP_OUT	O	Analog BP/RESP output signal	
7	ECG_OUT	O	Analog ECG output signal	

## Peripheral Expansion Interface

An 18-pin peripheral expansion interface is provided to support future use. An active low peripheral present signal may be polled by software to identify when a peripheral is attached to the Dash monitor. Asynchronous, Aux, and a switched Ethernet serial communication channels are supported as well as switched +9-18V and +5V power.

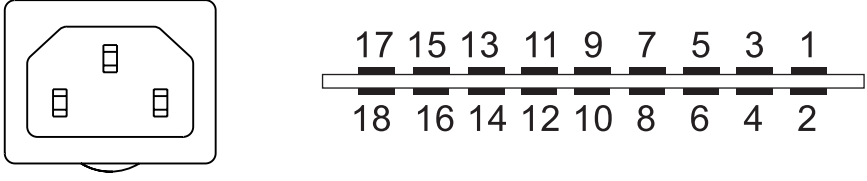
PIN	SIGNAL NAME	I/O	SIGNAL DESCRIPTION
 <p style="text-align: center;"><i>Bottom View of the Monitor</i></p>			
1	RETURN	–	Common power return
2	+9-18V	O	+9-18V power
3	PER_MARKER_OUT	O	Marker out
4	PER_ENET_PRESENT*	I	Signal to request switched Ethernet to peripheral
5	PER_ENET_TXD–	O	Transmit data + to peripheral
6	PER_ENET_RXD–	O	Transmit data – to peripheral
7	PER_ENET_TXD+	I	Receive data + from peripheral
8	PER_ENET_RXD+	I	Receive data – from peripheral
9	PER_AUTOPORT_ID_RXD	I	AutoPort ID RXD
10	PER_PRESENT*	I	Asserted by the installed peripheral device once powered
11	PER_ASYNC_RXD	I	Serial asynchronous data input from peripheral
12	PER_ASYNC_TXD	O	Serial asynchronous data output to peripheral
13	TC_PACER_BLANK*	O	Pacer blanking pulse from defibrillator
14	PER_AUTOPORT_ID_TXD	O	AutoPort ID TXD
15	PER_AUTOPORT_RXD	O	AutoPort RXD
16	PER_AUTOPORT_TXD	I	AutoPort TXD
17	+5V	O	+5V power
18	RETURN	–	Common power return







**GE Medical Systems**  
*Information Technologies*

---

[gemedicalsystems.com](http://gemedicalsystems.com)