

ENDOSCOPIC SYSTEMS

Product Catalog



Ordering Information.....	2
Product Support.....	3
Product Support and Service Programs.....	4
Digital Camera Systems.....	6
Xenon Light Sources and Light Guides.....	7
Medical Monitors.....	8
Surgical Video Carts and Accessories.....	9 – 11
Digital Documentation.....	12, 13
Video Color Printers.....	14
Autoclavable Small Joint Arthroscopes and Sheath Systems.....	15
Autoclavable Arthroscopes and Sheath Systems.....	16 – 19
Autoclavable Laparoscopes.....	20
Sterilization Trays.....	21
Video Accessories.....	22
Advanced Insufflation Systems.....	23, 24
Numerical Index.....	26 – 31
Alphabetical Index.....	32 – 37

All products may not be available in all markets.

To Place Your Order

**Please Contact Your Local Sales Representative
or Sales Office.**

**To identify your local Sales Representative of Sales Office
please contact ConMed Linvatec Customer Service, Largo,
Florida**

Phone: 727-392-6464

Fax: 727-397-4540

E-mail: custserv1@linvatec.com

ConMed Linvatec

Attn: Customer Service

11311 Concept Boulevard

Largo, FL 33773-4908 USA

At ConMed Linvatec, we want to offer more than a quality product. We take pride in being able to provide you with value added services to support our products. The information given in this catalog is designed to address your questions regarding product support.

Customer Support

If you encounter a problem or need technical assistance, contact Customer Service (Product Support) or your Sales Representative. Refer to the Customer Service telephone numbers listed on the opposite page.

Regulatory Compliance

Report any injuries or malfunctions to ConMed Linvatec Customer Service. Refer to the Customer Service telephone numbers listed.

Original Warranty

ConMed Linvatec (the "Company") warrants to the first purchaser or lessee ("You" or "Customer") that the instruments, attachments and parts manufactured by or for the Company (hereinafter collectively "Instruments") have been tested, inspected, and shipped in proper working order.

The Company warrants all new instruments to be free from defects in materials and workmanship for the following periods, measured from date of sale:

Original Warranties

MPower® and MPower 2 Handpieces	24 Months
Powered Surgical Instruments	12 Months
Power Attachments.....	12 Months
All Single Use Products.....	Upon Receipt
Handpiece Cords and Power Cords	6 Months
Pneumatic hoses	6 Months
Bur guards, blade guards, attachments	6 Months
Battery Packs.....	3 Months
Battery Chargers.....	12 Months
Camera Consoles	12 Months
Video Components	12 Months
Video Cables and Light Guides.....	3 Months
Scopes	12 Months
Camera Heads.....	12 Months
Shutt® Instruments.....	12 Months
Footswitches.....	12 Months
Irrigation Systems (pumps and remotes).....	12 Months
Reusable Procedure Specific Instruments.....	12 Months

Following the Original Warranty, ConMed Linvatec offers additional warranty and service programs that support our products throughout their lifetime. Service programs address the necessity to control cost and greatly reduce repair turnaround time by eliminating the need for repair quotes. Products not covered under a service program are subject to variable repair charges. To find out which service option best meets your needs, contact your local Sales Representative.

Service Agreements

Service Agreements provide additional service coverage on capital equipment. Contact your local Sales Representative for additional information.

Procedure for Returns/Repairs

1. All Instruments must be cleaned and sterilized, if appropriate, prior to return of any Instrument to a ConMed Linvatec repair facility.
2. An authorized Service Request (SR) Number must be obtained prior to returning any Instrument for repair/return.
3. To return a product for repair, contact ConMed Linvatec, your local repair facility, or your Sales Representative. The following information is needed to process a repair/return:
 - » Catalog Number
 - » Serial/Lot Number
 - » Original Invoice Number
 - » Detailed description of the problem or reason for return
 - » An SR Number
4. The SR number must be displayed on the outside of the box, included with all paperwork, and must be referred to when making an inquiry about the status of a repair/return.
5. ConMed Linvatec maintains various repair centers around the world. When you are issued your SR number, you will be advised of the location where to send your product.



IM4000

High Definition Camera System

- » 720p, 1080i and 1080p selectable
- » Upgradeable FPGA platform
- » True autoclavability
- » Eyecup, Cartridge and Urology autoclavable camera heads available

Cat. No.

High Definition Camera Controller.....	IM4000
High Definition 3CCD Camera Head – Eyecup.....	IM4120
High Definition 3CCD Camera Head – Cartridge.....	IM4121
High Definition 3CCD Camera Head – Broad Spectrum.....	IM4122
High Definition 3CCD Camera Head – Urology.....	IM4123



IM4120



IM4121



IM4123

All products may not be available in all markets.

High Definition Compatible Light Source

The HD Compatible 300 Watt Xenon Light Source from ConMed Linvatec is a stand-alone, user-friendly light source that provides optimal light output so even the most challenging surgical cases are adequately illuminated.

- » OLED window display with multi-function read out
- » HD Camera control connection allows surgeon to safely turn bulb stand-by on/off via the remote camera head button
- » HD Camera communication link allows light output to automatically adjust to optimal light intensity when using the IM4000 HD Camera
- » Universal light guide receptacle that accommodates both long and short light guide adapters
- » Auto bulb-saver feature designed to extend useful life of bulb when light source is not in use
- » Easy access bulb replacement
- » Locking feature to keep light guide securely in place
- » Compatible with ConMed's SMART OR™ Nurse's Assistant® OR Control and Integration Systems

Cat. No.

300 Watt Xenon Light Source	LS7700
300 Watt Replacement Bulb with Heat Sync	LS7701

300 Watt Xenon Light Source

Introducing the 300 Watt Xenon Light Source that provides the intense illumination necessary for endoscopic procedures. Features include:

- » 300 Watt Xenon bulb
- » Manual light intensity adjustment
- » Olympus style light guide receptacle
- » Improved light distribution

300 Watt Xenon Light Source	LS7600
300 Watt Replacement Bulb with mounting bracket	LS7601

Universal Light Guides

- » Autoclavable
- » Superior light transmission
- » Lightweight and flexible
- » Universal fittings

5mm Universal Light Guide, Translucent Blue	LG1050
3mm Universal Light Guide, 10'	C3279
5mm Universal Light Guide, 10'	C3278
Wolf, Dyonics Scope Fitting	7451
ACMI Scope Fitting	7452
Storz, Olympus Scope Fitting	7453
Wolf, Dyonics Light Source Fitting	7455
ACMI Light Source Fitting	7456
Storz Light Source Fitting	7457
Olympus Light Source Fitting	7458
Weck Xenon Light Source Fitting	7462
Replacement Scope Fiber Post Adapters	7513



LS7700



LS7600



LG1050



All products may not be available in all markets.



VP4726



VP4626C

High Definition 1080p LCD Monitors, Medical Grade

- » HD 1080p with 1920 x 1080 resolution
- » Sealed front panel with a protective coating for improved durability
- » Lightweight and modern design with a universal VESA mounting interface
- » Widescreen 16:9 Aspect Ratio
- » Picture-In-Picture (PIP) functionality
- » Compatible with ConMed's SMART OR™ Nurse's Assistant® OR Control and Integration Systems

Cat. No.

ConMed Linvatec 26" 1080p HD LCD Monitor.....	VP4726
ConMed Linvatec 26" 1080p HD LCD Monitor with Fiber Optic Input.....	VP4726F
ConMed Linvatec 32" 1080p HD LCD Monitor.....	VP4732
ConMed Linvatec 32" 1080p HD LCD Monitor with Fiber Optic Input.....	VP4732F
Replacement Power Supply for VP4726/F	VP4726PS
Replacement Power Supply for VP4732/F	VP4732PS

LCD Monitor Covers

- » Protects your investment when not in use

Cover for 26" LCD Monitor.....	VP4626C
Cover for 32" LCD Monitor.....	VP4632C

ConMed Linvatec Video Cart

ConMed Linvatec's next generation video cart is like nothing else on the market. The VP8500 Video Cart provides your OR with clean lines, new features and added flexibility. Providing a platform for High Definition or Enhanced Definition equipment, the VP8500 is designed to be as modern looking as the equipment on its shelves.

- » Five adjustable 14" wide shelves
- » HD-SDI output for auxiliary monitor
- » Stainless steel arms
- » Built-in isolation transformer and retractable cord-reel
- » Lockable rear doors
- » CO₂ tank holder

	Cat. No.
Video Cart, Standard	VP8500
Video Cart, Standard, 240 V for Export	VP8501
Video Cart, Standard, 110 V for Export	VP8502
Secondary Arm.....	VP8520
17" Wide Shelf	VP8540
Articulating Arm.....	VP8525
Post Mount (up to 25 lbs.).....	VP8526
Heavy Post Mount.....	VP8565



VP8500

ConMed Linvatec Standard Video cart

The ConMed Linvatec Standard Video Cart combines simplicity and ergonomics to provide an affordable alternative to more expensive video carts. Add optional accessories and video display mounting options as required.

- » Main power switch, 10 Outlet power strip and 15' power cord
- » Full length handle and accessory holder at each corner
- » 5 Easy-adjust shelves
- » 5" twin wheels (two locking)
- » Cable management system
- » Integrated isolation transformer

Specifications

- » Dimensions: 53" h x 27" w x 29" d (135cm h x 69cm w 73cm d)
- » Cart Weight: Approx. 230 lbs (508kg)
- » Shipping Weight: 280 lbs (619kg)
- » Input Voltage: 120 VAC, 60 Hz, 13.5 Amps maximum

ConMed Linvatec Standard Video Cart	VP6500
Articulating Arm.....	VP6525



VP6500

All products may not be available in all markets.

Surgical Video Carts and Accessories



VP4602



VP6526



VP6528, Monitor not included

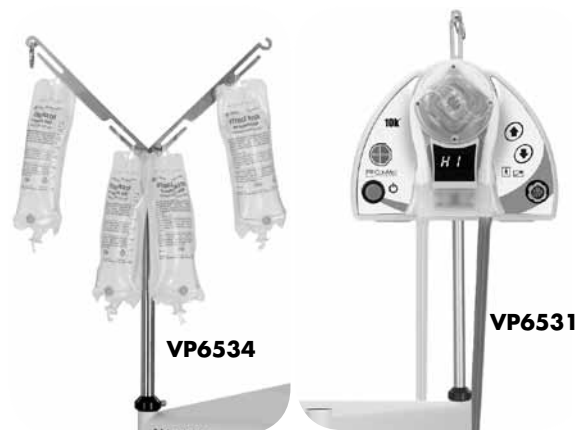

VP6534

VP6531

Flat Screen Roll Stand

Cat. No.

Flat Screen Roll Stand..... VP4602

Accessories for the VP6500 ConMed Linvatec Standard Video Cart

Main Flat Panel Post Mount

Mounts a main flat panel in place of the standard CRT tray on any VP6500 series video cart.

- » 18" high post with pan and tilt
- » Internal cable channel for easy cleaning
- » 100 mm flat panel mount (VESA Standard)
- » Accommodates 25 lb maximum flat panel weight (VP6526)
- » Accommodates 40 lb maximum flat panel weight (VP6565)

Main Flat Panel Post Mount..... VP6526

Heavy Panel, Flat Panel Post Mount VP6565

Secondary Flat Panel Arm

Add this clever pole (handle) mounted arm to any VP6500 series video cart for dual video monitor applications.

- » Mounts to any VP6500 series cart pole holder (handle)
- » Up to 17" extension from any corner of the video cart
- » 270° arm rotation with pan and tilt
- » Not compatible with VP6527 or VP6529 Primary Flat Panel Arms

Secondary Flat Panel Arm..... VP6528

Infusion Pole

- » Rear mounted pole fully retracts into holder (handle)
- » Holds up to four, 3 liter fluid bags (12 liter maximum)
- » Place up to two VP6534's on one cart

Infusion Pole, 4-bag VP6534

Pole Pump Mount

- » Allows for adjustable pump height
- » Compatible with ConMed Linvatec's 10k® Fluid Pump
- » Mounts to any corner of a VP6500 series video cart

Pole Pump Mount..... VP6531

All products may not be available in all markets.

CO₂ Tank Holder

- » Holds one or two medical-grade CO₂ E-tanks
- » Swings out for access to rear of cart
- » Locks securely in place

Cat. No.

CO₂ E-Tank Holder VP6533

Keyboard Tray

- » Ideal for storing the VP1500 Digital Documentation keyboard
- » Mounts under any standard VP6500 shelf
- » Interior dimensions 1.5" h x 17.5" w x 9.0" d

Keyboard Tray..... VP6542

Self Retracting Power Cord Module

- » 15' power cord on self-retracting reel
- » Requires VP6549 undercarriage for VP6500 and VP6503 carts

Power cord reel module..... VP6547

Drawer

- » Full-width drawer with lock and set of two keys
- » Mounts under any standard VP6500 series shelf
- » Interior dimensions 4.5" h x 17.5" w x 14.5" d

Drawer with lock VP6548

Miscellaneous Accessories

Replacement Shelf..... VP6543

Grip "O" Console Feet Holders, Qty 2..... 7444

Ordering Information

- » The video carts may also be customized with optional accessories. Accessories may not be compatible with all models. Check the product descriptions for details.
- » All display mounting options and accessories are sold separately but are factory installed when ordered with a video cart.
- » When ordering multiple carts of differing accessory configurations, please specify the quantity and configuration of each type cart.

Shipping Information

- » For U.S. deliveries, all video carts ship via ground transportation from Florida. Allow 48 hours for order processing and 5 to 7 days for delivery.
- » Inspect video cart packaging for shipping damage prior to accepting delivery. Refuse delivery if outer banding is loose or if damage to the cart or outer packaging is apparent. Contact ConMed Linvatec customer service for more information.



VP6533



VP6542



VP6547

All products may not be available in all markets.



High Definition Digital Recording System

HD video capture of surgical video images has arrived at ConMed Linvatec with the Med X Change DRSHD-L Digital Recording System - High Definition. The DRSHD-L is compatible with ConMed Linvatec's IM4000 HD Camera System and sports a full list of cutting edge technology features.

- » High Definition still image and motion video capture
- » Standard Definition still image and motion video capture
- » Four selectable video inputs
- » 15" touch screen user interface
- » Very large hard drive capacity
- » Speech response feedback – Confirms pause, record and still capture
- » Write captured video and still images to CD, DVD and USB storage devices
- » Network ready: TCP/IP, NetBUEI and IIS pre-installed
- » Print still images to Windows XP compatible and network printers
- » Playback of recorded video and still images on touch screen
- » Import stills and video into PowerPoint
- » Edit video on a Windows PC or Apple computer
- » Optional footswitch for still capture and record/pause

Specifications:

- » Still Capture: 1280 x 720 pixels BMP
- » Motion Video Capture: 720p, 59.94 MHz (1280 x 720 pixels), MPEG-4 compression, WMVHD File Format
- » Hard Drive Capacity: 455GB for video and still images
- » CD/DVD Writer: 18x Speed DVD writing
- » CPU Dimensions and Weight: 8.9" h x 10.5" w x 16.3" d, 18.4 lbs (8.35kg)
- » Touch Screen: 14" h x 13.8" w x 8" d, 16.13 lbs (Panel and base)

	Cat. No.
CPU, Digital Recording System HD	DRS01
Touch Screen, Digital Recording System HD.....	DRS02
Footswitch, 2 Pedal, Record and Still Capture	DRS03
Cable, 6', DVI-D to HDMI	DRS04
Adapter, BNC Female to RCA Male.....	DRS05
BW Remote Controller, for DRSHD.....	DRS06
Keyboard, USB, for DRSHD	DRS07
VGA Cable, 6'.....	DRS10
Power Supply for DRS02 Touch Screen	DRS11
Long Cable Kit for DRS02.....	DRS19
Software Upgrade Kit for DRS01	DRS20
Scaler, 1080p, Replacement.....	DRS21

High Definition Still Capture System

Capture, print and export 1080p still images with the HD Still Capture System from Conmed Linvatec. This HD Still Capture System is simple, easy-to-use and provides a range of image-preview options for the discerning surgeon. With its LINUX operating system and embedded system design, the HD Still Capture System starts up fast, recovers elegantly from power failures, and is more immune to computer viruses and network threats.

- » True-HD 1080p or 720p still capture
- » Full screen or thumbnail display of captured HD images
- » Full image review and delete capability
- » Print, save to USB or send images to PACS via DICOM
- » Easy and intuitive user interface
- » Upgradeable FPGA platform

Specifications

- » Input Voltage Range: 100 – 240 VAC, 50/60 Hz
- » Power Consumption: 100 VA maximum
- » Controller: 4.0" h x 14.0" w x 14.0" l (0.2cm h x 35.6cm w x 35.6cm l)
- » Keyboard: 0.9" h x 11.1" h x 5.3" d (2.3cm h x 28.2cm w x 13.5cm d)
- » Weight: 7 lbs. (3.2kg)

	Cat. No.
HD Still Capture System.....	VP1600
Sony MicroVault™ USB Flash Drive, 1 GB.....	USM1GL
Replacement Keyboard.....	VP1630



VP1600

All products may not be available in all markets.



UP-DR80MD

Sony Full Page Color Printer

The UP-DR80MD is the flagship printing option for HD image capture systems. It replaces the VP2750 (Sony UP-D55MD) at a lower price point, better image quality and a larger print format.

The UP-DR80MD prints in letter or A4 format and is medical grade. The UP-DR80MD is ideal for all applications where outstanding image quality and accurate color reproduction are essential. This fast and reliable dye sublimation printer is compact enough for video cart integration. With an optional network adapter kit, it is robust enough to serve as a network printer for multiple rooms.

Features

- » Premium, photo-realistic prints
- » High-speed printing
- » Compact size and stylish design
- » Fits well on surgical video carts
- » USB 2.0 connection
- » Self-laminating roll media
- » Easy to operate
- » Letter or A4 Paper Size/50 sheet capacity

Specifications

- » Input Voltage Range: 100 – 240 VAC, 5/60 Hz
- » Power Consumption: 100 VA maximum
- » Controller: 4.0" h x 14.0" w x 14.0" l (10.2cm h x 35.6cm w x 35.6cm l)
- » Keyboard: 0.9" h x 11.1" w x 5.3" d (2.3cm h x 28.2cm w x 13.5cm d)
- » Weight: 7 lbs. (3.2kg)

Cat. No.

Sony UP-DR80MD Full Page Digital Color Printer.....	UP-DR80MD
Color Print Pack, Letter Size, 100 Sheets	UPC-R81MD
Color Print Pack, A4 Size, 100 Sheets	UPC-R80MD
Network Adapter Kit for UP-DR80MD.....	UPDR80MD/KIT

Sony High Definition Color Video Printer

The VP2760 retains all features and standard definition performance of the VP2755, and adds HDTV Support. The VP2760 will capture and print 720p and 1080i HD video signals, making it an excellent documentation option for ConMed Linvatec's IM4000 HD Camera System. The VP2760 is factory configured to be ready-for-use with virtually no adjustment.

Features

- » Accepts 720p and 1080i video signals via a DVI to RGBS convertor box
- » Compatible with Standard Definition Composite, S-Video and RGBS video signals
- » ImagePort™ interface allows for HD digital file storage on a portable USB storage device such as Sony MicroVault™
- » Full HD resolution in 1 and 2 image-per-page printing
- » Archive quality, photo-like prints
- » Mechanically identical to the VP2755; 20-30 second print time, 100 sheet capacity, 6" x 7" paper, etc.
- » 3 pre-configured factory presets – ready-for-use with minimal adjustment

HD Color Video Printer.....	VP2760
Replacement HD Adapter Kit.....	VP2762
Color Print Pack, 2 x 100 sheets	VP2751



VP2760

Arthroscopes

ConMed Linvatec Autoclavable Arthroscopes offer excellent optical performance with state-of-the-art optical systems. Sapphire lenses ensure durability, decreasing costly repairs.

1.9mm Autoclavable Arthroscope

» Working Length 60mm

	Eyecup	Cartridge
1.9mm 0°	T1900	T1901
1.9mm 30°	T1930	T1931

Sheath System for 1.9mm Arthroscope

2.8mm Sheath	C3101
Blunt Obturator	C3102
Conical Obturator	C3103
Sharp Trocar	C3104

2.5mm Autoclavable Arthroscope

» Working Length 72mm

2.5mm 0°	T2500	T2501
2.5mm 30°	T2530	T2531
2.5mm 70°	T2570	T2571

Sheath System for 2.5mm Arthroscope

3.5mm Sheath	C3252
3.5mm Sheath with 30° tip	C3252-30
Blunt Obturator	C3253
Conical Obturator	C3254
Sharp Trocar	C3255



All products may not be available in all markets.

Autoclavable Arthroscopes and Sheath Systems



T2930



T4932

QuickLatch® Autoclavable 2.9mm Arthroscope

ConMed Linvatec's 2.9mm Arthroscope offers superior optical performance in a smaller package than a standard 4mm arthroscope. Features include:

- » 2.9mm outside diameter
- » Working length 152mm
- » 100° field-of-view
- » 0°, 30°, 45° and 70° angle-of-view
- » Equivalent light transmission and image size to a 4mm arthroscope
- » Increased depth-of-field and less distortion compared to competitive 4mm arthroscopes
- » Increased durability with new proprietary sheath system

	Eyecup	Cartridge
2.9mm 0°	T2900	T2901
2.9mm 30°	T2930	T2931
2.9mm 45°	T2944	T2945
2.9mm 70°	T2970	T2971

QuickLatch Sheath System for 2.9mm Arthroscope

A proprietary scope-sheath interface offers better protection of the arthroscope and increased flow efficiency.

- » Smaller outside diameter allows for better maneuverability
- » Scope-sheath interface ensures excellent tip protection
- » Ease-of-use increases efficiency

	Cat. No.
4.0mm Small Joint Single Stopcock Sheath	T4031
4.0mm Small Joint Double Stopcock Sheath	T4032
4.7mm Arthroscopy Single Stopcock Sheath	T4731
4.7mm Arthroscopy Double Stopcock Sheath	T4732
5.2mm High Flow Single Stopcock Sheath	T4931
5.2mm High Flow Double Stopcock Sheath	T4932
5.2mm Pressure Sensing Single Stopcock Sheath System	T5131
5.2mm Pressure Sensing Double Stopcock Sheath System	T5132
Blunt Obturator	T4901
Conical Obturator	T4902
Sharp Trocar	T4903
Sheath Body O-ring (replacement), Qty. 2	T4904
Stopcock O-ring (replacement), Qty. 4	T4908
11" Switching Stick	T4906-11
14" Switching Stick	T4906
Arthroscopic Portal Rod	T4907
Stopcock Locking Nut	T4905
Single Stopcock Bridge	T4911
Double Stopcock Bridge	T4912
Stopcock Lock	T4914
Pressure Sensing Bridge Adapter	T4910
Pressure Sensing Single Stopcock Assembly	T5101
Pressure Sensing Double Stopcock Assembly	T5102
Pressure Sensing Outer Tip Assembly	T5103
Pressure Sensing Stopcock O-ring	T5104
Pressure Sensing Outer Tip Assembly O-ring	T5105
Arthroscopy Sheath Body (replacement)	T4730
Arthroscopy High Flow Sheath Body (replacement)	T4930
Pressure Sensing Sheath Body	T5130

All products may not be available in all markets.

HD Autoclavable 4mm Arthroscope

ConMed Linvatec's 4mm HD Arthroscope features state-of-the-art optics with an innovative scope-sheath interface.

» Working length 170mm

	Eyecup	Cartridge
4mm 0°	HD4000	HD4001
4mm 30°	HD4300	HD4301
4mm 70°	HD4700	HD4701

QuickLatch® Sheath System for 4mm Arthroscope

Proprietary scope-sheath interface offers ease-of-use with better protection of the arthroscope and increased flow efficiency.

- » 5.5mm and 5.9mm Outside diameter sheaths
- » Scope-sheath interface increases durability and provides excellent tip protection of the arthroscope

	Cat. No.
5.5mm Arthroscopy Sheath Kit	
Single Stopcock	QL5531
Double Stopcock	QL5532
5.9mm High Flow Sheath Kit	
Single Stopcock	QL6131
Double Stopcock	QL6132
5.9mm Pressure Sensing Sheath Kit	
Single Stopcock	QL6231
Double Stopcock	QL6232
Switching Sticks	
11" Switching Stick	T4906-11
14" Switching Stick	T4906
Arthroscopic Portal Rod	T4907
QuickLatch® Stopcock Lock	T4914

DoubleLatch™ Bridge System

Single Stopcock DoubleLatch™ Bridge	DL6111
Double Stopcock DoubleLatch Bridge	DL6112
5.8mm DoubleLatch Cannula with Valve	DL5801V
5.8mm DoubleLatch Retaining Cannula with Valve	DL5802V
5.8mm DoubleLatch Conical Obturator	DL5804
10 Replacement Seals for DoubleLatch Cannulas	DL1008
Replacement Cannula Seal Cap	DL1009
Seal Cap Installation and Removal Tool	DL1010

QuickLatch Bridge Systems for 4mm Arthroscope

Single Stopcock Bridge	QL6111
Double Stopcock Bridge	QL6112
Pressure Sensing Bridge Adapter	QL6210
Pressure Sensing Bridge Adapter for Extended Length Cannulas	QL6210XL
Scope Cleaning Kit	T0001

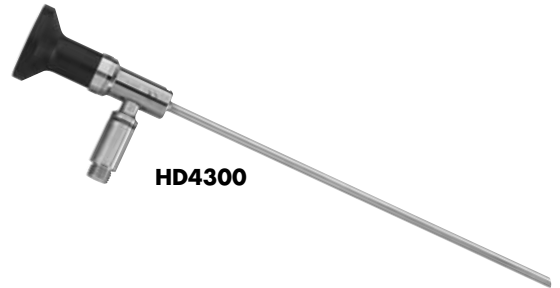

HD4300



QL6132

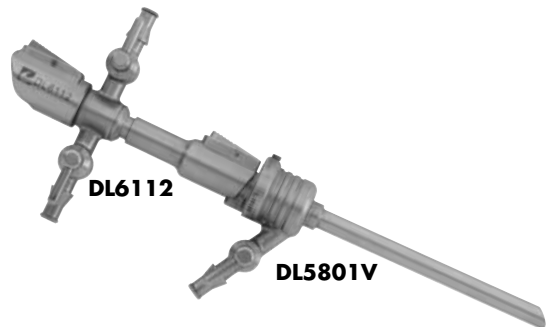

DL6112

DL5801V



QL6230, T5102, QL6210

All products may not be available in all markets.

Autoclavable Arthroscopes and Sheath Systems



Replacement Parts

	Cat. No.
Blunt Obturator	QL6101
Conical Obturator	QL6102
Sharp Trocar	QL6103
Cannulated Obturator	QL6104
(compatible with ConMed Linvatec's 2220, T4906, and T4906-11 Switching Sticks)	
Sheath Body O-ring (Replacement), Qty. 2	T4904
Stopcock O-ring (Replacement), Qty. 4	T4908
Stopcock Locking Nut	T4905
Single Stopcock Assembly	T5801
Double Stopcock Assembly	T5802
Pressure Sensing Single Stopcock Assembly	T5101
Pressure Sensing Double Stopcock Assembly	T5102
Pressure Sensing Outer Tip Assembly	QL6201
Pressure Sensing Stopcock O-ring (replacement)	T5104
Pressure Sensing O-ring, Outer Tip Assembly, Qty. 2	QL6205
Pressure Sensing 5.9mm Sheath Body	QL6230

Bridge Cannulas

4.6mm Stainless Steel Cannula	OC4601
4.6mm Stainless Steel 30°/70° Cannula	OC4606
(for use with ConMed Linvatec's T-series 4mm Arthroscopes)	
4.6mm Stainless Steel Fenestrated Cannula	OC4607
4.6mm Trocar	OC4603
4.6mm Conical Obturator	OC4604
4.6mm Cannulated Obturator	OC4605
(compatible with ConMed Linvatec's 2220, T4906, and T4906-11 Switching Sticks)	
5.8mm Stainless Steel Cannula	OC5801
5.8mm Stainless Steel 30°/70° Cannula	OC5806
(for use with ConMed Linvatec's T-series 4mm Arthroscopes)	
5.8mm Trocar	OC5803
5.8mm Conical Obturator	OC5804
5.8mm Cannulated Obturator	OC5805
(compatible with ConMed Linvatec's 2220, T4906, and T4906-11 Switching Sticks)	
5.8mm Extended Length Stainless Steel Cannula	OC5801XL
(compatible with QuickLatch® 4mm Arthroscopes and T4911, T4912, or QL6210LX Bridge Adapters)	
5.8mm Extended Length Conical Obturator	OC5804XL
7.6mm Stainless Steel Cannula	OC7601
7.6mm Stainless Steel 30°/70° Cannula	OC7606
(for use with ConMed Linvatec's T-series 4mm Arthroscopes)	
7.6mm Trocar	OC7603
7.6mm Conical Obturator	OC7604
7.6mm Cannulated Obturator	OC7605
(compatible with ConMed Linvatec's 2220, T4906, and T4906-11 Switching Sticks)	
Silicone Cannula Seal (latex free), 1 per package	7557
Infusion Adapter	7554

Pressure Sensing Cannula System

For use with the 87k® Fluid Control System and Apex Pressure Sensing tubing sets. This system allows for true intra-articular pressure measurement.

- » Dual cannulation to provide separate fluid inflow and pressure measurement
- » Outer cannula is removable for patient entry and cleaning
- » Fenestrations

For a complete set-order: Inner Cannula, Outer Cannula, Trocar, Obturator, and Inflow Adapter.

	Inner Cannula	Outer Cannula	Trocar	Obturator	Inflow Adapter*
5.1mm O.D.					
3.5" (89mm) Length	83255	83256	83257	83258 ...	83234
5.0" (127mm) Length	83225	83226	83227	83228 ...	83234

Cat. No.

Inflow Adapter for 5.1mm O.D. cannula system (converts to Luer) 83234

	Inner Cannula	Outer Cannula	Trocar	Obturator	Inflow Adapter*
6.3mm O.D.					
3.5" (89mm) Length	83244	83243	83241	83242 ...	83235
5.0" (127mm) Length	83264	83263	83261	83262 ...	83235

Cat. No.

Replacement O-ring for Outer Cannulas 78807039595

Replacement Parts for Quick-Connect® Sheath Sets

(T5830, T5831, T5832, T5833, T5870, T5871, T5872, and T5873)

Quick-Connect sheaths are compatible with ConMed Linvatec's non-QuickLatch® 4mm Arthroscopes.

5.8mm Fenestrated 30° Sheath Body	T5834
5.8mm Non-Fenestrated 30° Sheath Body	T5835
5.8mm Fenestrated 30°/70° Sheath Body	T5874
5.8mm Non-Fenestrated 30°/70° Sheath Body	T5875
4.5mm Switching Stick	T5845
Single Stopcock Bridge	T5811
Double Stopcock Bridge	T5812
Blunt Obturator	T5803
Conical Obturator	T5804
Sharp Trocar	T5805
Single Stopcock Assembly	T5801
Double Stopcock Assembly	T5802
Stopcock Lock	T5814
Replacement O-ring for Sheath	T4908
Replacement Stopcock Nut	T4905

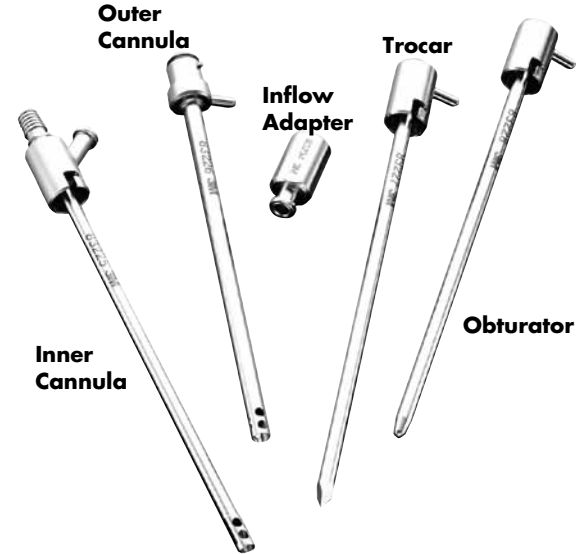

All products may not be available in all markets.



HD5500



HD1000

Laparoscopes

ConMed Linvatec Autoclavable Laparoscopes offer excellent optical performance with state-of-the-art optical systems. Sapphire lenses ensure durability, decreasing costly repairs.

5.5mm HD Autoclavable Laparoscope

» Working length 325mm

	Eyecup	Cartridge
5.5mm 0°	HD5500	HD5501
5.5mm 30°	HD5530	HD5531
5.5mm 45°	HD5544	HD5545

5.5mm HD Autoclavable Extended Length Laparoscope

» Working Length 450mm

	Eyecup	Cartridge
5.5mm 0°	HD5500XL	HD5501XL
5.5mm 30°	HD5530XL	HD5531XL
5.5mm 45°	HD5544XL	HD5545XL

10mm HD Autoclavable Laparoscope

» Working length 325mm

	Eyecup	Cartridge
10mm 0°	HD1000	HD1001
10mm 30°	HD1030	HD1031
10mm 45°	HD1044	HD1045

10mm Autoclavable Extended Length Laparoscope

» Working Length 450mm

	Eyecup	Cartridge
10mm 0°	T1000B	T1001B
10mm 30°	T1030B	T1031B
10mm 45°	T1044B	T1045B

Sterilization Trays

ConMed Linvatec offers an assortment of plastic trays to hold endoscopes, and other sterilizable video and hand instruments for storage, sterilization and soaking. Endoscopes are cradled in protective silicone to prevent possible damage during handling, soaking, sterilization or storage.

	Cat. No.
Autoclavable Arthroscope Tray (holds 2 scopes) Dimensions 3.2" w x 1.4" h x 12" d	C3106
Autoclavable Laparoscope Tray (holds 2 scopes) Dimensions 3.2" w x 1.4" h x 17" d	C3107
Autoclavable Tray for camera head, light guide and endoscopes Dimensions 9.7" w x 2.20" h x 20.5" d	C3108

Autoclavable Tray-two inner trays. Holds multiple products for arthroscopic/ laparoscopic procedures. Modular plastic tray holds camera head, light guide (bottom section), handpiece and pump remote (removable mid section), and arthroscopes and inflow devices (removable top sections). Laparoscopes or hysteroscopes can be placed in bottom or top sections.

Dimensions 9.7" w x 4.75" h x 20.5" d	C3109
---------------------------------------------	-------

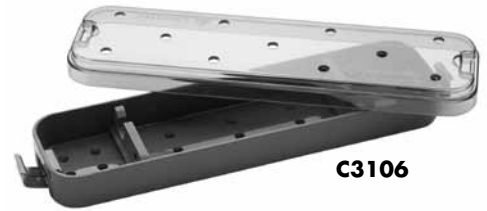

C3106

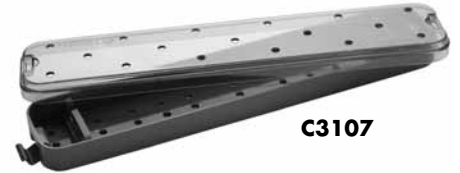

C3107



C3109

Ultra-Stop® Anti-Fog

Ultra-Stop® is a transparent, and non-hazardous anti-fog agent which prevents lens fogging (similar to ethyl alcohol).

Ultra-Stop	110201
------------------	--------

Ultra-Stop is a registered trademark of Sigmapharm.



All products may not be available in all markets.

Adapters

	Cat. No.
3.5mm T-Splitter Cable	IM9005
Cable, 3.5mm to 3.5mm Stereo Remote.....	IM9001
Cable, Izziton Monitor Record Light	7149

Replacement Lamps

Bulb Assembly for C3140.....	C3141
With Bracket for LS7500	LS7501
With Bracket for LS7600	LS7601
With Bracket for LS7700	LS7701
With Bracket for 8425, 8425A, 8425E, 8425AE, 250W	8426
With Bracket for 8430/8430W, Xenon, 8420E/8430WE, 300W .	8431

Cables, Composite Video

6' BNC Cable	8175-06
20' BNC Cable	8175-20

Cables, DVI-D

DVI-D video cable, DVI to DVI, 3'	IM9020
DVI-D video cable, DVI to DVI, 6'	IM9021
DVI-D video cable, DVI to DVI, 25'	IM9022

Cables, HD-SDI

HD-SDI video cable, BNC to BNC, 3'	IM9010
HD-SDI video cable, BNC to BNC, 6'	IM9011
HD-SDI video cable, BNC to BNC, 25'	IM9012

Cables, RGB

RGB Video Cable, 4' (4-BNC to 4-BNC)	C3186
RGB Video Cable, 6' (4-BNC to 4-BNC)	8174
RGB Video Cable, 6' (HD15 to 4-BNC)	VP9501
RGB Video Cable, 25' (4-BNC to 4-BNC)	VP9503
RGB Video Cable, 25' (HD15 to 4-BNC)	VP9504
RGB Video Cable, 1' (4-BNC Female to HD15 Male).....	VP9505

Cables, "S" Video

	Cat. No.
3' "S" Cable	8149-3
6' "S" Cable	8149-06
25' "S" Cable	8149-20
50' "S" Cable	8149-50
75' "S" Cable	8149-75

Drapes

9 x 95" Camera Drape, Qty. 10 (latex free product).....	9707
5 x 95" Camera Drape, Qty. 10 (latex free product).....	60-3950-031

Power Cords

1' Power Cord, 115V	C7104-1
2' Power Cord, 115V	C7104-2
3' Power Cord, 115V	C7104-3
4' Power Cord, 115V	C7104-4
6' Power Cord, 115V	C7104
10' Power Cord, 230V	C7105

Print/Ink Sets

Print/Ink Set, for 8122, 8124 (200 Prints).....	8123
Print/Ink Set, for 3172 (100 Prints).....	C3173
Print/Ink Set, 6/pk for C3172.....	C3174
Print/Ink Set, for 8132 (80 Prints).....	8133
Print/Ink Set, for 8134, 8134A, 8143B (100 Prints)	8136
Print/Ink Set, for C3149 (200 Prints)	C3271
Print/Ink Set, for VP2721 (200 Prints)	VP2722
Print/Ink Set, for VP2750, VP2755 (200 Prints)	VP2751
Print/Ink Set, for UPDR80MD, Letter	UPC-R81MD
Print/Ink Set, for UPDR80MD, A4	UPC-R80MD

ConMed Linvatec 40L – Dual Port Insufflator

The ConMed Linvatec 40L Insufflator incorporates state-of-the-art technology in insufflation and has advanced features for all types of laparoscopic surgery. The 40L Insufflator is compatible with three ConMed Linvatec insufflation tubing sets to ensure tubing standardization with previous Linvatec insufflators. Uses one or two warmers per console (sold separately).

Advanced New Features for Enhanced Safety

- » 40 LPM maximum flow Rate-Safe insufflation for any laparoscopic procedure
- » Dual gas outputs – Delivers twice the actual flow rate of single port insufflators
- » CPS™ compatible – Continuous Pressure Sensing increases average flow rate, manages leaks better and eliminates the “breathing effect” (CPS tubing sold separately)
- » Gas warmer compatible – Ergonomic delivery of body temperature CO₂
- » SMART OR™ compatible – Nurse’s Assistant® OR Control and display of insufflator functions and readings
- » Video Display – Displays pressure flow and volume readings on a video monitor

Specifications:

- » Dimensions: 13.3" w x 6.9" h x 14.8" d (34cm x 18cm x 38cm)
- » Weight: Approx. 24 lbs (10.9kg)
- » Input Voltage Range: 90 – 240 VAC, 50 – 60 Hz

Cat. No.

ConMed Linvatec 40L Dual Port Insufflator GS1002



GS1002

ConMed Linvatec 35L – Single Port Insufflator

The ConMed Linvatec 35L Insufflator is an economical high-performance insufflation system. The 35L Insufflator utilizes many of the same features as the 40L Insufflator for safe distension pressure control during all phases of laparoscopic surgery. The 35L is also compatible with three ConMed Linvatec insufflation tubing sets to ensure tubing standardization with existing insufflation systems.

High-Performance and Economical

- » 35 LPM maximum gas flow
- » Gas warmer compatible – Ergonomic delivery of body temperature CO₂
- » Single gas output – Simplicity and high-performance
- » Automatically adjusts to E-Tank and “wall” gas pressures

Specifications:

- » Dimensions: 13.3" w x 6.9" h x 14.8" d (34cm x 18cm x 38cm)
- » Weight: Approx. 23 lbs (10.4kg)
- » Input Voltage Range: 90 – 240 VAC, 50 – 60 Hz

ConMed Linvatec 35L Single Port Insufflator GS1000



GS1000

Insufflator Accessories

- High Pressure Hose and Yoke for CO₂ E-Tank, 4' GS1052
(included with GS1000 and GS1002)
- Low Pressure Hose for “wall” CO₂, 7/16" female flare to DISS female, 2' GS1053
- Low Pressure Hose for “wall” CO₂, 7/16" female flare to DISS female, 4' GS1055
- Low Pressure Hose for “wall” CO₂, 7/16" female flare to DISS female, 6' GS1056
- Power Cord, 115 VAC, 6' C7104
- Power Cord, 230 VAC, 10' C7105

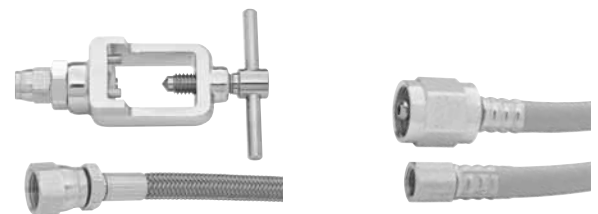

GS1052

GS1053

All products may not be available in all markets.



CO₂ Warming System

ConMed Linvatec's second generation warming system safely delivers body-temperature gas in an ergonomic and easy-to-use package. Gas warming is achieved by inserting the small warmer assembly into the gas path near the distal end of a standard insufflation tubing set. The warmer assembly is powered by either ConMed Linvatec 35L or 40L Insufflator.

- » Safe – Warmer stays cool to touch
- » Cost Effective – Uses standard insufflation tubing
- » Easy-to-Use – Lightweight and ergonomic

Cat. No.

CO₂ Warmer, in-line, reusable *GS1012

Cleaning Brushes for Warmer assembly 10/pkg GS1054

*Requires insufflation tubing set



CPS™ Continuous Pressure Sensing Tubing Set (Latex Free)

The ConMed Linvatec CPS feature enhances insufflation safety and performance by increasing average flow rate, maintaining stable pressure during gas leaks and eliminating the "breathing effect" during insufflation. Compatible only with the ConMed Linvatec 40L Insufflator (GS1002).

CPS Tubing Set, disposable, with filter GS1013



CO₂ Output Adapters for ConMed Linvatec Insufflators

Standardize to one tubing set with ConMed Linvatec insufflator gas port adapters. These stainless steel adapters attach to your ConMed Linvatec 35L or 40L Insufflator to allow use of tubing sets made for ConMed Linvatec C7000 or C7000A Insufflators. The adapters are non-rotating and include tethers for permanent attachment to ConMed Linvatec 35L or 40L Insufflator chassis. Order one each of the desired adapter for the GS1000 or two each for the GS1002.

Adapter, CO₂ Output, CPC to IEC (for C7011 tubing) GS1050

Adapter, CO₂ Output, CPC to Luer (for C7010 tubing) GS1051

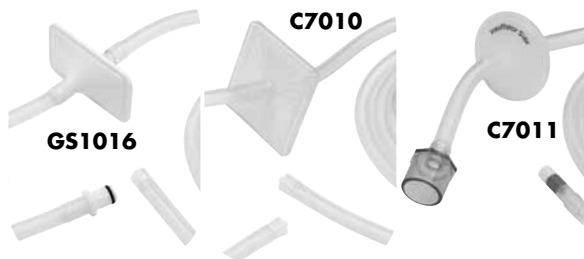

Insufflation Tubing Sets (Latex Free)

ConMed Linvatec offers three different insufflation tubing sets to meet your standardization needs.

Insufflation tubing set, disposable, CPC to Luer, with filter GS1016

Insufflation tubing set, disposable, Luer to Luer, with filter C7010

Insufflation tubing set, disposable, IEC to Luer, with filter C7011

ENDOSCOPIC SYSTEMS INDEX

Numerical Index



Cat. No.	Description	Page No.
0.7554	Infusion Adapter	18
7149	Cable, Izziton Monitor Record Light	22
7444	Grip "O" Console Feet Holders, Qty 2	11
7451	Wolf, Dyonics Scope Fitting	7
7452	ACMI Scope Fitting	7
7453	Storz, Olympus Scope Fitting	7
7455	Wolf, Dyonics Light Source Fitting	7
7456	ACMI Light Source Fitting	7
7457	Storz Light Source Fitting	7
7458	Olympus Light Source Fitting	7
7462	Weck Xenon Light Source Fitting	7
7513	Replacement Scope Fiber Post Adapters	7
7557	Silicone Cannula Seal (latex free), 1 per package	18
8123	Print/Ink Set, for 8122, 8124 (200 Prints)	22
8133	Print/Ink Set, for 8132 (80 Prints)	22
8136	Print/Ink Set, for 8134, 8134A, 8143B (100 Prints)	22
8174	RGB Video Cable, 6' (4-BNC to 4-BNC)	22
8426	Replacement Lamps, With Bracket for 8425, 8425A, 8425E, 8425AE, 250W	22
8431	Replacement Lamps, With Bracket for 8430/8430W, Xenon, 8420E/8430WE, 300W	22
9707	9 x 95" Camera Drape, Qty. 10 (latex free product)	22
83225	5.1mm O.D., 5.0" (127mm) Length, inner Cannula	19
83226	5.1mm O.D., 5.0" (127mm) Length, Outer Cannula	19
83227	5.1mm O.D., 5.0" (127mm) Length, Trocar	19
83228	5.1mm O.D., 5.0" (127mm) Length, Obturator	19
83234	5.1mm O.D., 3.5" (89mm) Length, Inflow Adapter	19
83234	5.1mm O.D., 5.0" (127mm) Length, Inflow Adapter	19
83234	Inflow Adapter for 5.1mm O.D. cannula system (converts to Luer)	19
83235	6.3mm O.D., 3.5" (89mm) Length, Inflow Adapter	19
83235	6.3mm O.D., 5.0" (127mm) Length, Inflow Adapter	19
83241	6.3mm O.D., 3.5" (89mm) Length, Trocar	19
83242	6.3mm O.D., 3.5" (89mm) Length, Obturator	19
83243	6.3mm O.D., 3.5" (89mm) Length, Outer Cannula	19
83244	6.3mm O.D., 3.5" (89mm) Length, inner Cannula	19
83255	5.1mm O.D., 3.5" (89mm) Length, inner Cannula	19
83256	5.1mm O.D., 3.5" (89mm) Length, Outer Cannula	19
83257	5.1mm O.D., 3.5" (89mm) Length, Trocar	19
83258	5.1mm O.D., 3.5" (89mm) Length, Obturator	19
83261	6.3mm O.D., 5.0" (127mm) Length, Trocar	19
83262	6.3mm O.D., 5.0" (127mm) Length, Obturator	19
83263	6.3mm O.D., 5.0" (127mm) Length, Outer Cannula	19
83264	6.3mm O.D., 5.0" (127mm) Length, inner Cannula	19
110201	Ultra-Stop® Anti-Fog	21
78807039595	Replacement O-ring for Outer Cannulas	19
60-3950-031	5 x 95" Camera Drape, Qty. 10 (latex free product)	22
8149-06	6' "S" Cable	22
8149-20	25' "S" Cable	22
8149-3	3' "S" Cable	22
8149-50	50' "S" Cable	22
8149-75	75' "S" Cable	22
8175-06	6' BNC Cable	22
8175-20	20' BNC Cable	22
C3101	2.8mm Sheath, for 1.9mm Arthroscope	15
C3102	Blunt Obturator, for 1.9mm Arthroscope	15
C3103	Conical Obturator, for 1.9mm Arthroscope	15
C3104	Sharp Trocar, for 1.9mm Arthroscope	15
C3106	Autoclavable Arthroscope Tray (holds 2 scopes), Dimensions 3.2" w x 1.4" h x 12" d	21
C3107	Autoclavable Laparoscope Tray (holds 2 scopes), Dimensions 3.2" w x 1.4" h x 17" d	21
C3108	Autoclavable Tray for camera head, light guide and endoscopes, Dimensions 9.7" w x 2.20" h x 20.5" d	21
C3109	Autoclavable Tray, Dimensions 9.7" w x 4.75" h x 20.5" d	21

Cat. No.	Description	Page No.
C3111A	Replacement Keyboard	6
C3141	Bulb Assembly for C3140	22
C3173	Print/Ink Set, for 3172 (100 Prints)	22
C3174	Print/Ink Set, 6/pk for C3172	22
C3186	RGB Video Cable, 4' (4-BNC to 4-BNC)	22
C3252	3.5mm Sheath for 2.5mm Arthroscope	15
C3252-30	3.5mm Sheath with 30° tip for 2.5mm Arthroscope	15
C3253	Blunt Obturator for 2.5mm Arthroscope	15
C3254	Conical Obturator for 2.5mm Arthroscope	15
C3255	Sharp Trocar for 2.5mm Arthroscope	15
C3271	Print/Ink Set, for C3149 (200 Prints)	22
C3278	5mm Universal Light Guide, 10'	7
C3279	3mm Universal Light Guide, 10'	7
C7010	Insufflation tubing set, disposable, Luer to Luer, with filter	24
C7011	Insufflation tubing set, disposable, IEC to Luer, with filter	24
C7104	6' Power Cord, 115V	22, 23
C7104-1	1' Power Cord, 115V	22
C7104-2	2' Power Cord, 115V	22
C7104-3	3' Power Cord, 115V	22
C7104-4	4' Power Cord, 115V	22
C7105	10' Power Cord, 230V	22, 23
DL1008	10 Replacement Seals for DoubleLatch Cannulas	17
DL1009	Replacement Cannula Seal Cap	17
DL1010	Seal Cap Installation and Removal Tool	17
DL5801V	5.8mm DoubleLatch Cannula with Valve	17
DL5802V	5.8mm DoubleLatch Retaining Cannula with Valve	17
DL5804	5.8mm DoubleLatch Conical Obturator	17
DL6111	Single Stopcock DoubleLatch™ Bridge	17
DL6112	Double Stopcock DoubleLatch Bridge	17
DRS01	CPU, Digital Recording System HD	12
DRS02	Touch Screen, Digital Recording System HD	12
DRS03	Footswitch, 2 Pedal, Record and Still Capture	12
DRS04	Cable, 6', DVI-D to HDMI	12
DRS05	Adapter, BNC Female to RCA Male	12
DRS06	BW Remote Controller, for DRSHD	12
DRS07	Keyboard, USB, for DRSHD	12
DRS10	VGA Cable, 6'.	12
DRS11	Power Supply for DRS02 Touch Screen	12
DRS19	Long Cable Kit for DRS02	12
DRS20	Software Upgrade Kit for DRS01	12
DRS21	Scaler, 1080p, Replacement	12
GS1000	ConMed Linvatec 35L Single Port Insufflator	23
GS1002	ConMed Linvatec 40L Dual Port Insufflator	23
GS1012	CO ₂ Warmer, in-line, reusable	24
GS1013	CPS Tubing Set, disposable, with filter	24
GS1016	Insufflation tubing set, disposable, CPC to Luer, with filter	24
GS1050	Adapter, CO ₂ Output, CPC to IEC (for C7011 tubing)	24
GS1051	Adapter, CO ₂ Output, CPC to Luer (for C7010 tubing)	24
GS1052	High Pressure Hose and Yoke for CO ₂ E-Tank, 4'	23
GS1053	Low Pressure Hose for "wall" CO ₂ , 7/16" female flare to DISS female, 2'	23
GS1054	Cleaning Brushes for Warmer assembly 10/pkg	24
GS1055	Low Pressure Hose for "wall" CO ₂ , 7/16" female flare to DISS female, 4'	23
GS1056	Low Pressure Hose for "wall" CO ₂ , 7/16" female flare to DISS female, 6'	23
HD1000	10mm 0°, HD Autoclavable Laparoscope, Eyecup	20
HD1001	10mm 0°, HD Autoclavable Laparoscope, Cartridge	20
HD1030	10mm 30°, HD Autoclavable Laparoscope, Eyecup	20
HD1031	10mm 30°, HD Autoclavable Laparoscope, Cartridge	20
HD1044	10mm 45°, HD Autoclavable Laparoscope, Eyecup	20
HD1045	10mm 45°, HD Autoclavable Laparoscope, Cartridge	20

Numerical Index



Cat. No.	Description	Page No.
HD4000	4mm 0°, HD Autoclavable Arthroscope, Eyecup	17
HD4001	4mm 0°, HD Autoclavable Arthroscope, Cartridge	17
HD4300	4mm 30°, HD Autoclavable Arthroscope, Eyecup	17
HD4301	4mm 30°, HD Autoclavable Arthroscope, Cartridge	17
HD4700	4mm 70°, HD Autoclavable Arthroscope, Eyecup	17
HD4701	4mm 70°, HD Autoclavable Arthroscope, Cartridge	17
HD5500	5.5mm 0°, HD Autoclavable Laparoscope, Eyecup	20
HD5500XL	5.5mm 0°, HD Autoclavable Extended Length Laparoscope, Eyecup	20
HD5501	5.5mm 0°, HD Autoclavable Laparoscope, Cartridge	20
HD5501XL	5.5mm 0°, HD Autoclavable Extended Length Laparoscope, Cartridge	20
HD5530	5.5mm 30°, HD Autoclavable Laparoscope, Eyecup	20
HD5530XL	5.5mm 30°, HD Autoclavable Extended Length Laparoscope, Eyecup	20
HD5531	5.5mm 30°, HD Autoclavable Laparoscope, Cartridge	20
HD5531XL	5.5mm 30°, HD Autoclavable Extended Length Laparoscope, Cartridge	20
HD5544	5.5mm 45°, HD Autoclavable Laparoscope, Eyecup	20
HD5544XL	5.5mm 45°, HD Autoclavable Extended Length Laparoscope, Eyecup	20
HD5545	5.5mm 45°, HD Autoclavable Laparoscope, Cartridge	20
HD5545XL	5.5mm 45°, HD Autoclavable Extended Length Laparoscope, Cartridge	20
IM2120	Enhanced Definition Camera Head – Eyecup	6
IM2121	Enhanced Definition Camera Head – Cartridge	6
IM4000	High Definition Camera Controller	6
IM4120	High Definition 3CCD Camera Head – Eyecup	6
IM4121	High Definition 3CCD Camera Head – Cartridge	6
IM4122	High Definition 3CCD Camera Head – Broad Spectrum	6
IM4123	High Definition 3CCD Camera Head – Urology	6
IM9001	Cable, 3.5mm to 3.5mm Stereo Remote	22
IM9005	3.5mm T-Splitter Cable	22
IM9010	HD-SDI video cable, BNC to BNC, 3'	22
IM9011	HD-SDI video cable, BNC to BNC, 6'	22
IM9012	HD-SDI video cable, BNC to BNC, 25'	22
IM9020	DVI-D video cable, DVI to DVI, 3'	22
IM9021	DVI-D video cable, DVI to DVI, 6'	22
IM9022	DVI-D video cable, DVI to DVI, 25'	22
LG1050	5mm Universal Light Guide, Translucent Blue	7
LS7501	Replacement Lamps, With Bracket for LS7500	22
LS7600	Enhanced Definition Compatible 300 Watt Xenon Light Source	7
LS7601	300 Watt Replacement Bulb with mounting bracket	7, 22
LS7700	High Definition Compatible 300 Watt Xenon Light Source	7
LS7701	300 Watt Replacement Bulb with Heat Sync	7, 22
OC4601	4.6mm Stainless Steel Cannula	18
OC4603	4.6mm Trocar	18
OC4604	4.6mm Conical Obturator	18
OC4605	4.6mm Cannulated Obturator	18
OC4606	4.6mm Stainless Steel 30°/70° Cannula	18
OC4607	4.6mm Stainless Steel Fenestrated Cannula	18
OC5801	5.8mm Stainless Steel Cannula	18
OC5801XL	5.8mm Extended Length Stainless Steel Cannula	18
OC5803	5.8mm Trocar	18
OC5804	5.8mm Conical Obturator	18
OC5804XL	5.8mm Extended Length Conical Obturator	18
OC5805	5.8mm Cannulated Obturator	18
OC5806	5.8mm Stainless Steel 30°/70° Cannula	18
OC7601	7.6mm Stainless Steel Cannula	18
OC7603	7.6mm Trocar	18
OC7604	7.6mm Conical Obturator	18
OC7605	7.6mm Cannulated Obturator	18
OC7606	7.6mm Stainless Steel 30°/70° Cannula	18
QL5531	5.5mm Arthroscopy Sheath Kit, Single Stopcock, QuickLatch® for 4mm Arthroscope	17
QL5532	5.5mm Arthroscopy Sheath Kit, Double Stopcock, QuickLatch for 4mm Arthroscope	17

Cat. No.	Description	Page No.
QL6101	Blunt Obturator	18
QL6102	Conical Obturator	18
QL6103	Sharp Trocar	18
QL6104	Cannulated Obturator	18
QL6111	Single Stopcock Bridge, QuickLatch® for 4mm Arthroscope	17
QL6112	Double Stopcock Bridge, QuickLatch for 4mm Arthroscope	17
QL6131	5.9mm High Flow Sheath Kit, Single Stopcock, QuickLatch for 4mm Arthroscope	17
QL6132	5.9mm High Flow Sheath Kit, Double Stopcock, QuickLatch for 4mm Arthroscope	17
QL6201	Pressure Sensing Outer Tip Assembly	18
QL6205	Pressure Sensing O-ring, Outer Tip Assembly, Qty. 2	18
QL6210	Pressure Sensing Bridge Adapter, QuickLatch for 4mm Arthroscope	17
QL6210XL	Pressure Sensing Bridge Adapter for Extended Length Cannulas, QuickLatch for 4mm Arthroscope	17
QL6230	Pressure Sensing 5.9mm Sheath Body	18
QL6231	5.9mm Pressure Sensing Sheath Kit, Single Stopcock, QuickLatch for 4mm Arthroscope	17
QL6232	5.9mm Pressure Sensing Sheath Kit, Double Stopcock, QuickLatch for 4mm Arthroscope	17
T0001	Scope Cleaning Kit	17
T1000B	10mm 0°, Autoclavable Extended Length Laparoscope, Eyecup	20
T1001B	10mm 0°, Autoclavable Extended Length Laparoscope, Cartridge	20
T1030B	10mm 30°, Autoclavable Extended Length Laparoscope, Eyecup	20
T1031B	10mm 30°, Autoclavable Extended Length Laparoscope, Cartridge	20
T1044B	10mm 45°, Autoclavable Extended Length Laparoscope, Eyecup	20
T1045B	10mm 45°, Autoclavable Extended Length Laparoscope, Cartridge	20
T1900	1.9mm 0°, Autoclavable Arthroscope, Eyecup	15
T1901	1.9mm 0°, Autoclavable Arthroscope, Cartridge	15
T1930	1.9mm 30°, Autoclavable Arthroscope, Eyecup	15
T1931	1.9mm 30°, Autoclavable Arthroscope, Cartridge	15
T2500	2.5mm 0°, Autoclavable Arthroscope, Eyecup	15
T2501	2.5mm 0°, Autoclavable Arthroscope, Cartridge	15
T2530	2.5mm 30°, Autoclavable Arthroscope, Eyecup	15
T2531	2.5mm 30°, Autoclavable Arthroscope, Cartridge	15
T2570	2.5mm 70°, Autoclavable Arthroscope, Eyecup	15
T2571	2.5mm 70°, Autoclavable Arthroscope, Cartridge	15
T2900	2.9mm 0°, QuickLatch Autoclavable Arthroscope, Eyecup	16
T2901	2.9mm 0°, QuickLatch Autoclavable Arthroscope, Cartridge	16
T2930	2.9mm 30°, QuickLatch Autoclavable Arthroscope, Eyecup	16
T2931	2.9mm 30°, QuickLatch Autoclavable Arthroscope, Cartridge	16
T2944	2.9mm 45°, QuickLatch Autoclavable Arthroscope, Eyecup	16
T2945	2.9mm 45°, QuickLatch Autoclavable Arthroscope, Cartridge	16
T2970	2.9mm 70°, QuickLatch Autoclavable Arthroscope, Eyecup	16
T2971	2.9mm 70°, QuickLatch Autoclavable Arthroscope, Cartridge	16
T4031	4.0mm Small Joint Single Stopcock Sheath, QuickLatch® for 2.9mm Arthroscope	16
T4032	4.0mm Small Joint Double Stopcock Sheath, QuickLatch for 2.9mm Arthroscope	16
T4730	Arthroscopy Sheath Body (replacement)	16
T4731	4.7mm Arthroscopy Single Stopcock Sheath, QuickLatch for 2.9mm Arthroscope	16
T4732	4.7mm Arthroscopy Double Stopcock Sheath, QuickLatch for 2.9mm Arthroscope	16
T4901	Blunt Obturator	16
T4902	Conical Obturator	16
T4903	Sharp Trocar	16
T4904	Sheath Body O-ring (Replacement), Qty. 2	16, 18
T4905	Stopcock Locking Nut	16 – 19
T4906	14" Switching Stick, QuickLatch for 4mm Arthroscope	16, 17
T4906-11	11" Switching Stick, QuickLatch for 4mm Arthroscope	16, 17
T4907	Arthroscopic Portal Rod, QuickLatch for 4mm Arthroscope	16, 17
T4908	Replacement O-ring for Sheath	16 – 19
T4910	Pressure Sensing Bridge Adapter	16
T4911	Single Stopcock Bridge	16
T4912	Double Stopcock Bridge	16
T4914	QuickLatch Stopcock Lock, QuickLatch for 4mm Arthroscope	16, 17
T4930	Arthroscopy High Flow Sheath Body (replacement)	16

Numerical Index



Cat. No.	Description	Page No.
T4931	5.2mm High Flow Single Stopcock Sheath, QuickLatch for 2.9mm Arthroscope	16
T4932	5.2mm High Flow Double Stopcock Sheath, QuickLatch for 2.9mm Arthroscope	16
T5101	Pressure Sensing Single Stopcock Assembly	16, 18
T5102	Pressure Sensing Double Stopcock Assembly	16, 18
T5103	Pressure Sensing Outer Tip Assembly	16
T5104	Pressure Sensing Stopcock O-ring	16, 18
T5105	Pressure Sensing Outer Tip Assembly O-ring	16
T5130	Pressure Sensing Sheath Body	16
T5131	5.2mm Pressure Sensing Single Stopcock Sheath System	16
T5132	5.2mm Pressure Sensing Double Stopcock Sheath System	16
T5801	Single Stopcock Assembly	18, 19
T5802	Double Stopcock Assembly	18, 19
T5803	Blunt Obturator	19
T5804	Conical Obturator	19
T5805	Sharp Trocar	19
T5811	Single Stopcock Bridge	19
T5812	Double Stopcock Bridge	19
T5814	Stopcock Lock	19
T5834	5.8mm Fenestrated 30° Sheath Body	19
T5835	5.8mm Non-Fenestrated 30° Sheath Body	19
T5845	4.5mm Switching Stick	19
T5874	5.8mm Fenestrated 30°/70° Sheath Body	19
T5875	5.8mm Non-Fenestrated 30°/70° Sheath Body	19
UP-DR80MD	Sony UP-DR80MD Full Page Digital Color Printer	14
UPC-R80MD	Print/Ink Set, for UPDR80MD, A4	14, 22
UPC-R81MD	Print/Ink Set, for UPDR80MD, Letter	14, 22
UPDR80MD/KIT	Network Adapter Kit for UP-DR80MD	14
USM1GL	Sony MicroVault™ USB Flash Drive, 1 GB	13
VP1600	HD Still Capture System	13
VP1630	Replacement Keyboard	13
VP2722	Print/Ink Set, for VP2721 (200 Prints)	22
VP2751	Color Print Pack, 2 x 100 sheets	14
VP2751	Print/Ink Set, for VP2750, VP2755 (200 Prints)	22
VP2760	HD Color Video Printer	14
VP2762	Replacement HD Adapter Kit	14
VP4602	Flat Screen Roll Stand	10
VP4626C	Cover for 26" LCD Monitor	8
VP4632C	Cover for 32" LCD Monitor	8
VP4726	ConMed Linvatec 26" 1080p HD LCD Monitor	8
VP4726F	ConMed Linvatec 26" 1080p HD LCD Monitor with Fiber Optic Input	8
VP4726PS	Replacement Power Supply for VP4726/F	8
VP4732	ConMed Linvatec 32" 1080p HD LCD Monitor	8
VP4732F	ConMed Linvatec 32" 1080p HD LCD Monitor with Fiber Optic Input	8
VP4732PS	Replacement Power Supply for VP4732/F	8
VP6500	ConMed Linvatec Standard Video Cart	9
VP6525	Articulating Arm	9
VP6526	Main Flat Panel Post Mount	10
VP6528	Secondary Flat Panel Arm	10
VP6531	Pole Pump Mount	10
VP6533	CO ₂ E-Tank Holder	11
VP6534	Infusion Pole, 4-bag	10
VP6542	Keyboard Tray	11
VP6543	Replacement Shelf	11
VP6547	Power cord reel module	11
VP6548	Drawer with lock	11
VP6565	Heavy Panel, Flat Panel Post Mount	10
VP8500	Video Cart, Standard	9
VP8501	Video Cart, Standard, 240 V for Export	9
VP8502	Video Cart, Standard, 110 V for Export	9

Cat. No.	Description	Page No.
VP8510	Footpedal Storage	9
VP8520	Secondary Arm	9
VP8525	Articulating Arm	9
VP8526	Post Mount (up to 25 lbs.)	9
VP8532	32" Monitor Yoke	9
VP8540	17" Wide Shelf	9
VP8565	Heavy Post Mount	9
VP9501	RGB Video Cable, 6' (HD15 to 4-BNC)	22
VP9503	RGB Video Cable, 25' (4-BNC to 4-BNC)	22
VP9504	RGB Video Cable, 25' (HD15 to 4-BNC)	22
VP9505	RGB Video Cable, 1' (4-BNC Female to HD15 Male)	22
	The Integrated Smart OR™	26
	Service Arms	26
	Service Managers	26
	Integrated Nurse Station	27
	Nurse's Assistant® OR Control System	27
	Surgeon's Assistant™ Touch Panel	27
	Link Assistant™ Communication System	27

Alphabetical Index



Cat. No.	Description	Page No.
T1901	1.9mm 0°, Autoclavable Arthroscope, Cartridge	15
T1900	1.9mm 0°, Autoclavable Arthroscope, Eyecup	15
T1931	1.9mm 30°, Autoclavable Arthroscope, Cartridge	15
T1930	1.9mm 30°, Autoclavable Arthroscope, Eyecup	15
C7104-1	1' Power Cord, 115V	22
DL1008	10 Replacement Seals for DoubleLatch™ Cannulas	17
C7105	10' Power Cord, 230V	22, 23
120304	10cm, Verres Needle	33
T1001B	10mm 0°, Autoclavable Extended Length Laparoscope, Cartridge	20
T1000B	10mm 0°, Autoclavable Extended Length Laparoscope, Eyecup	20
HD1001	10mm 0°, HD Autoclavable Laparoscope, Cartridge	20
HD1000	10mm 0°, HD Autoclavable Laparoscope, Eyecup	20
T1031B	10mm 30°, Autoclavable Extended Length Laparoscope, Cartridge	20
T1030B	10mm 30°, Autoclavable Extended Length Laparoscope, Eyecup	20
HD1031	10mm 30°, HD Autoclavable Laparoscope, Cartridge	20
HD1030	10mm 30°, HD Autoclavable Laparoscope, Eyecup	20
T1045B	10mm 45°, Autoclavable Extended Length Laparoscope, Cartridge	20
T1044B	10mm 45°, Autoclavable Extended Length Laparoscope, Eyecup	20
HD1045	10mm 45°, HD Autoclavable Laparoscope, Cartridge	20
HD1044	10mm 45°, HD Autoclavable Laparoscope, Eyecup	20
T4906-11	11" Switching Stick, QuickLatch® for 4mm Arthroscope	16, 17
T4906	14" Switching Stick, QuickLatch for 4mm Arthroscope	16, 17
VP8540	17" Wide Shelf	9
T2501	2.5mm 0°, Autoclavable Arthroscope, Cartridge	15
T2500	2.5mm 0°, Autoclavable Arthroscope, Eyecup	15
T2531	2.5mm 30°, Autoclavable Arthroscope, Cartridge	15
T2530	2.5mm 30°, Autoclavable Arthroscope, Eyecup	15
T2571	2.5mm 70°, Autoclavable Arthroscope, Cartridge	15
T2570	2.5mm 70°, Autoclavable Arthroscope, Eyecup	15
C3101	2.8mm Sheath, for 1.9mm Arthroscope	15
T2901	2.9mm 0°, QuickLatch Autoclavable Arthroscope, Cartridge	16
T2900	2.9mm 0°, QuickLatch Autoclavable Arthroscope, Eyecup	16
T2931	2.9mm 30°, QuickLatch Autoclavable Arthroscope, Cartridge	16
T2930	2.9mm 30°, QuickLatch Autoclavable Arthroscope, Eyecup	16
T2945	2.9mm 45°, QuickLatch Autoclavable Arthroscope, Cartridge	16
T2944	2.9mm 45°, QuickLatch Autoclavable Arthroscope, Eyecup	16
T2971	2.9mm 70°, QuickLatch Autoclavable Arthroscope, Cartridge	16
T2970	2.9mm 70°, QuickLatch Autoclavable Arthroscope, Eyecup	16
C7104-2	2' Power Cord, 115V	22
8175-20	20' BNC Cable	22
8149-20	25' "S" Cable	22
C3252	3.5mm Sheath for 2.5mm Arthroscope	15
C3252-30	3.5mm Sheath with 30° tip for 2.5mm Arthroscope	15
IM9005	3.5mm T-Splitter Cable	22
8149-3	3' "S" Cable	22
C7104-3	3' Power Cord, 115V	22
LS7701	300 Watt Replacement Bulb with Heat Sync	7, 22
LS7601	300 Watt Replacement Bulb with mounting bracket	7, 22
VP8532	32" Monitor Yoke	9
C3279	3mm Universal Light Guide, 10'	7
T4032	4.0mm Small Joint Double Stopcock Sheath, QuickLatch for 2.9mm Arthroscope	16
T4031	4.0mm Small Joint Single Stopcock Sheath, QuickLatch for 2.9mm Arthroscope	16
T5845	4.5mm Switching Stick	19
OC4605	4.6mm Cannulated Obturator	18
OC4604	4.6mm Conical Obturator	18
OC4606	4.6mm Stainless Steel 30°/70° Cannula	18
OC4601	4.6mm Stainless Steel Cannula	18
OC4607	4.6mm Stainless Steel Fenestrated Cannula	18
OC4603	4.6mm Trocar	18

Cat. No.	Description	Page No.
T4732	4.7mm Arthroscopy Double Stopcock Sheath, QuickLatch® for 2.9mm Arthroscope	16
T4731	4.7mm Arthroscopy Single Stopcock Sheath, QuickLatch for 2.9mm Arthroscope	16
C7104-4	4' Power Cord, 115V	22
HD4001	4mm 0°, HD Autoclavable Arthroscope, Cartridge	17
HD4000	4mm 0°, HD Autoclavable Arthroscope, Eyecup	17
HD4301	4mm 30°, HD Autoclavable Arthroscope, Cartridge	17
HD4300	4mm 30°, HD Autoclavable Arthroscope, Eyecup	17
HD4701	4mm 70°, HD Autoclavable Arthroscope, Cartridge	17
HD4700	4mm 70°, HD Autoclavable Arthroscope, Eyecup	17
60-3950-031	5 x 95" Camera Drape, Qty. 10 (latex free product)	22
83234	5.1mm O.D., 3.5" (89mm) Length, Inflow Adapter	19
83255	5.1mm O.D., 3.5" (89mm) Length, inner Cannula	19
83258	5.1mm O.D., 3.5" (89mm) Length, Obturator	19
83256	5.1mm O.D., 3.5" (89mm) Length, Outer Cannula	19
83257	5.1mm O.D., 3.5" (89mm) Length, Trocar	19
83234	5.1mm O.D., 5.0" (127mm) Length, Inflow Adapter	19
83225	5.1mm O.D., 5.0" (127mm) Length, inner Cannula	19
83228	5.1mm O.D., 5.0" (127mm) Length, Obturator	19
83226	5.1mm O.D., 5.0" (127mm) Length, Outer Cannula	19
83227	5.1mm O.D., 5.0" (127mm) Length, Trocar	19
T4932	5.2mm High Flow Double Stopcock Sheath, QuickLatch for 2.9mm Arthroscope	16
T4931	5.2mm High Flow Single Stopcock Sheath, QuickLatch for 2.9mm Arthroscope	16
T5132	5.2mm Pressure Sensing Double Stopcock Sheath System	16
T5131	5.2mm Pressure Sensing Single Stopcock Sheath System	16
HD5501XL	5.5mm 0°, HD Autoclavable Extended Length Laparoscope, Cartridge	20
HD5500XL	5.5mm 0°, HD Autoclavable Extended Length Laparoscope, Eyecup	20
HD5501	5.5mm 0°, HD Autoclavable Laparoscope, Cartridge	20
HD5500	5.5mm 0°, HD Autoclavable Laparoscope, Eyecup	20
HD5531XL	5.5mm 30°, HD Autoclavable Extended Length Laparoscope, Cartridge	20
HD5530XL	5.5mm 30°, HD Autoclavable Extended Length Laparoscope, Eyecup	20
HD5531	5.5mm 30°, HD Autoclavable Laparoscope, Cartridge	20
HD5530	5.5mm 30°, HD Autoclavable Laparoscope, Eyecup	20
HD5545XL	5.5mm 45°, HD Autoclavable Extended Length Laparoscope, Cartridge	20
HD5544XL	5.5mm 45°, HD Autoclavable Extended Length Laparoscope, Eyecup	20
HD5545	5.5mm 45°, HD Autoclavable Laparoscope, Cartridge	20
HD5544	5.5mm 45°, HD Autoclavable Laparoscope, Eyecup	20
QL5532	5.5mm Arthroscopy Sheath Kit, Double Stopcock, QuickLatch® for 4mm Arthroscope	17
QL5531	5.5mm Arthroscopy Sheath Kit, Single Stopcock, QuickLatch for 4mm Arthroscope	17
OC5805	5.8mm Cannulated Obturator	18
OC5804	5.8mm Conical Obturator	18
DL5801V	5.8mm DoubleLatch Cannula with Valve	17
DL5804	5.8mm DoubleLatch Conical Obturator	17
DL5802V	5.8mm DoubleLatch Retaining Cannula with Valve	17
OC5804XL	5.8mm Extended Length Conical Obturator	18
OC5801XL	5.8mm Extended Length Stainless Steel Cannula	18
T5834	5.8mm Fenestrated 30° Sheath Body	19
T5874	5.8mm Fenestrated 30°/70° Sheath Body	19
T5835	5.8mm Non-Fenestrated 30° Sheath Body	19
T5875	5.8mm Non-Fenestrated 30°/70° Sheath Body	19
OC5806	5.8mm Stainless Steel 30°/70° Cannula	18
OC5801	5.8mm Stainless Steel Cannula	18
OC5803	5.8mm Trocar	18
QL6132	5.9mm High Flow Sheath Kit, Double Stopcock, QuickLatch for 4mm Arthroscope	17
QL6131	5.9mm High Flow Sheath Kit, Single Stopcock, QuickLatch for 4mm Arthroscope	17
QL6232	5.9mm Pressure Sensing Sheath Kit, Double Stopcock, QuickLatch for 4mm Arthroscope	17
QL6231	5.9mm Pressure Sensing Sheath Kit, Single Stopcock, QuickLatch for 4mm Arthroscope	17
8149-50	50' "S" Cable	22
C3278	5mm Universal Light Guide, 10'	7
LG1050	5mm Universal Light Guide, Translucent Blue	7

Alphabetical Index



Cat. No.	Description	Page No.
83235	6.3mm O.D., 3.5" (89mm) Length, Inflow Adapter	19
83244	6.3mm O.D., 3.5" (89mm) Length, inner Cannula	19
83242	6.3mm O.D., 3.5" (89mm) Length, Obturator	19
83243	6.3mm O.D., 3.5" (89mm) Length, Outer Cannula	19
83241	6.3mm O.D., 3.5" (89mm) Length, Trocar	19
83235	6.3mm O.D., 5.0" (127mm) Length, Inflow Adapter	19
83264	6.3mm O.D., 5.0" (127mm) Length, inner Cannula	19
83262	6.3mm O.D., 5.0" (127mm) Length, Obturator	19
83263	6.3mm O.D., 5.0" (127mm) Length, Outer Cannula	19
83261	6.3mm O.D., 5.0" (127mm) Length, Trocar	19
8149-06	6' "S" Cable	22
8175-06	6' BNC Cable	22
C7104	6' Power Cord, 115V	22, 23
OC7605	7.6mm Cannulated Obturator	18
OC7604	7.6mm Conical Obturator	18
OC7606	7.6mm Stainless Steel 30°/70° Cannula	18
OC7601	7.6mm Stainless Steel Cannula	18
OC7603	7.6mm Trocar	18
8149-75	75' "S" Cable	22
9707	9 x 95" Camera Drape, Qty. 10 (latex free product)	22
7456	ACMI Light Source Fitting	7
7452	ACMI Scope Fitting	7
DRS05	Adapter, BNC Female to RCA Male	12
GS1050	Adapter, CO2 Output, CPC to IEC (for C7011 tubing)	24
GS1051	Adapter, CO2 Output, CPC to Luer (for C7010 tubing)	24
T4907	Arthroscopic Portal Rod, QuickLatch® for 4mm Arthroscope	16, 17
T4930	Arthroscopy High Flow Sheath Body (replacement)	16
T4730	Arthroscopy Sheath Body (replacement)	16
VP6525	Articulating Arm	9
VP8525	Articulating Arm	9
C3106	Autoclavable Arthroscope Tray (holds 2 scopes), Dimensions 3.2" w x 1.4" h x 12" d	21
C3107	Autoclavable Laparoscope Tray (holds 2 scopes), Dimensions 3.2" w x 1.4" h x 17" d	21
C3108	Autoclavable Tray for camera head, light guide and endoscopes, Dimensions 9.7" w x 2.20" h x 20.5" d	21
C3109	Autoclavable Tray, Dimensions 9.7" w x 4.75" h x 20.5" d	21
QL6101	Blunt Obturator	18
T4901	Blunt Obturator	16
T5803	Blunt Obturator	19
C3253	Blunt Obturator for 2.5mm Arthroscope	15
C3102	Blunt Obturator, for 1.9mm Arthroscope	15
C3141	Bulb Assembly for C3140	22
DRS06	BW Remote Controller, for DRSHD	12
IM9001	Cable, 3.5mm to 3.5mm Stereo Remote	22
DRS04	Cable, 6', DVI-D to HDMI	12
7149	Cable, Izziton Monitor Record Light	22
QL6104	Cannulated Obturator	18
GS1054	Cleaning Brushes for Warmer assembly 10/pkg	24
VP6533	CO ₂ E-Tank Holder	11
GS1012	CO ₂ Warmer, in-line, reusable	24
VP2751	Color Print Pack, 2 x 100 sheets	14
QL6102	Conical Obturator	18
T4902	Conical Obturator	16
T5804	Conical Obturator	19
C3254	Conical Obturator for 2.5mm Arthroscope	15
C3103	Conical Obturator, for 1.9mm Arthroscope	15
VP4726	ConMed Linvatec 26" 1080p HD LCD Monitor	8
VP4726F	ConMed Linvatec 26" 1080p HD LCD Monitor with Fiber Optic Input	8
VP4732	ConMed Linvatec 32" 1080p HD LCD Monitor	8
VP4732F	ConMed Linvatec 32" 1080p HD LCD Monitor with Fiber Optic Input	8
GS1000	ConMed Linvatec 35L Single Port Insufflator	23

Cat. No.	Description	Page No.
GS1002	ConMed Linvatec 40L Dual Port Insufflator	23
VP6500	ConMed Linvatec Standard Video Cart	9
VP4626C	Cover for 26" LCD Monitor	8
VP4632C	Cover for 32" LCD Monitor	8
GS1013	CPS Tubing Set, disposable, with filter	24
DRS01	CPU, Digital Recording System HD	12
T5802	Double Stopcock Assembly	18, 19
T4912	Double Stopcock Bridge	16
T5812	Double Stopcock Bridge	19
QL6112	Double Stopcock Bridge, QuickLatch® for 4mm Arthroscope	17
DL6112	Double Stopcock DoubleLatch™ Bridge	17
VP6548	Drawer with lock	11
IM9022	DVI-D video cable, DVI to DVI, 25'	22
IM9020	DVI-D video cable, DVI to DVI, 3'	22
IM9021	DVI-D video cable, DVI to DVI, 6'	22
IM2121	Enhanced Definition Camera Head – Cartridge	6
IM2120	Enhanced Definition Camera Head – Eyecup	6
LS7600	Enhanced Definition Compatible 300 Watt Xenon Light Source	7
VP4602	Flat Screen Roll Stand	10
VP8510	Footpedal Storage	9
DRS03	Footswitch, 2 Pedal, Record and Still Capture	12
7444	Grip "O" Console Feet Holders, Qty 2	11
VP2760	HD Color Video Printer	14
VP1600	HD Still Capture System	13
IM9012	HD-SDI video cable, BNC to BNC, 25'	22
IM9010	HD-SDI video cable, BNC to BNC, 3'	22
IM9011	HD-SDI video cable, BNC to BNC, 6'	22
VP6565	Heavy Panel, Flat Panel Post Mount	10
VP8565	Heavy Post Mount	9
IM4122	High Definition 3CCD Camera Head – Broad Spectrum	6
IM4121	High Definition 3CCD Camera Head – Cartridge	6
IM4120	High Definition 3CCD Camera Head – Eyecup	6
IM4123	High Definition 3CCD Camera Head – Urology	6
IM4000	High Definition Camera Controller	6
LS7700	High Definition Compatible 300 Watt Xenon Light Source	7
GS1052	High Pressure Hose and Yoke for CO ₂ , E-Tank, 4'	23
83234	Inflow Adapter for 5.1mm O.D. cannula system (converts to Luer)	19
0.7554	Infusion Adapter	18
VP6534	Infusion Pole, 4-bag	10
GS1016	Insufflation tubing set, disposable, CPC to Luer, with filter	24
C7011	Insufflation tubing set, disposable, IEC to Luer, with filter	24
C7010	Insufflation tubing set, disposable, Luer to Luer, with filter	24
	Integrated Nurse Station	27
VP6542	Keyboard Tray	11
DRS07	Keyboard, USB, for DRSHD	12
DRS19	Long Cable Kit for DRS02	12
GS1053	Low Pressure Hose for "wall" CO ₂ , 7/16" female flare to DISS female, 2'	23
GS1055	Low Pressure Hose for "wall" CO ₂ , 7/16" female flare to DISS female, 4'	23
GS1056	Low Pressure Hose for "wall" CO ₂ , 7/16" female flare to DISS female, 6'	23
VP6526	Main Flat Panel Post Mount	10
UPDR80MD/KIT	Network Adapter Kit for UP-DR80MD	14
	Nurse's Assistant® OR Control System	27
7458	Olympus Light Source Fitting	7
VP6531	Pole Pump Mount	10
VP8526	Post Mount (up to 25 lbs.)	9
VP6547	Power cord reel module	11
DRS11	Power Supply for DRS02 Touch Screen	12
QL6230	Pressure Sensing 5.9mm Sheath Body	18
T4910	Pressure Sensing Bridge Adapter	16

Alphabetical Index



Cat. No.	Description	Page No.
QL6210XL	Pressure Sensing Bridge Adapter for Extended Length Cannulas, QuickLatch® for 4mm Arthroscope	17
QL6210	Pressure Sensing Bridge Adapter, QuickLatch for 4mm Arthroscope	17
T5102	Pressure Sensing Double Stopcock Assembly	16, 18
QL6205	Pressure Sensing O-ring, Outer Tip Assembly, Qty. 2	18
QL6201	Pressure Sensing Outer Tip Assembly	18
T5103	Pressure Sensing Outer Tip Assembly	16
T5105	Pressure Sensing Outer Tip Assembly O-ring	16
T5130	Pressure Sensing Sheath Body	16
T5101	Pressure Sensing Single Stopcock Assembly	16, 18
T5104	Pressure Sensing Stopcock O-ring	16, 18
C3174	Print/Ink Set, 6/pk for C3172	22
C3173	Print/Ink Set, for 3172 (100 Prints)	22
8123	Print/Ink Set, for 8122, 8124 (200 Prints)	22
8133	Print/Ink Set, for 8132 (80 Prints)	22
8136	Print/Ink Set, for 8134, 8134A, 8143B (100 Prints)	22
C3271	Print/Ink Set, for C3149 (200 Prints)	22
UPC-R80MD	Print/Ink Set, for UPDR80MD, A4	14, 22
UPC-R81MD	Print/Ink Set, for UPDR80MD, Letter	14, 22
VP2722	Print/Ink Set, for VP2721 (200 Prints)	22
VP2751	Print/Ink Set, for VP2750, VP2755 (200 Prints)	22
T4914	QuickLatch Stopcock Lock, QuickLatch for 4mm Arthroscope	16, 17
DL1009	Replacement Cannula Seal Cap	17
VP2762	Replacement HD Adapter Kit	14
C3111A	Replacement Keyboard	6
VP1630	Replacement Keyboard	13
8426	Replacement Lamps, With Bracket for 8425, 8425A, 8425E, 8425AE, 250W	22
8431	Replacement Lamps, With Bracket for 8430/8430W, Xenon, 8420E/8430WE, 300W	22
LS7501	Replacement Lamps, With Bracket for LS7500	22
78807039595	Replacement O-ring for Outer Cannulas	19
T4908	Replacement O-ring for Sheath	16 - 19
VP4726PS	Replacement Power Supply for VP4726/F	8
VP4732PS	Replacement Power Supply for VP4732/F	8
7513	Replacement Scope Fiber Post Adapters	7
VP6543	Replacement Shelf	11
VP9505	RGB Video Cable, 1' (4-BNC Female to HD15 Male)	22
VP9503	RGB Video Cable, 25' (4-BNC to 4-BNC)	22
VP9504	RGB Video Cable, 25' (HD15 to 4-BNC)	22
C3186	RGB Video Cable, 4' (4-BNC to 4-BNC)	22
8174	RGB Video Cable, 6' (4-BNC to 4-BNC)	22
VP9501	RGB Video Cable, 6' (HD15 to 4-BNC)	22
DRS21	Scaler, 1080p, Replacement	12
T0001	Scope Cleaning Kit	17
DL1010	Seal Cap Installation and Removal Tool	17
VP8520	Secondary Arm	9
VP6528	Secondary Flat Panel Arm	10
	Service Arms	26
	Service Managers	26
QL6103	Sharp Trocar	18
T4903	Sharp Trocar	16
T5805	Sharp Trocar	19
C3255	Sharp Trocar for 2.5mm Arthroscope	15
C3104	Sharp Trocar, for 1.9mm Arthroscope	15
T4904	Sheath Body O-ring (Replacement), Qty. 2	16, 18
7557	Silicone Cannula Seal (latex free), 1per package .	18
T5801	Single Stopcock Assembly	18, 19
T4911	Single Stopcock Bridge	16
T5811	Single Stopcock Bridge	19
QL6111	Single Stopcock Bridge, QuickLatch® for 4mm Arthroscope	17
DL6111	Single Stopcock DoubleLatch™ Bridge	17

Cat. No.	Description	Page No.
DRS20	Software Upgrade Kit for DRS01	12
USM1GL	Sony MicroVault™ USB Flash Drive, 1 GB	13
UP-DR80MD	Sony UP-DR80MD Full Page Digital Color Printer	14
113509	Spring with Teflon® Guides for all Hasson graspers	29
T5814	Stopcock Lock	19
T4905	Stopcock Locking Nut	16 – 19
7457	Storz Light Source Fitting	7
7453	Storz, Olympus Scope Fitting	7
	Surgeon's Assistant™ Touch Panel	27
	The Integrated Smart OR™	26
DRS02	Touch Screen, Digital Recording System HD	12
110201	Ultra-Stop® Anti-Fog	21
DRS10	VGA Cable, 6'.	12
VP8500	Video Cart, Standard	9
VP8502	Video Cart, Standard, 110 V for Export	9
VP8501	Video Cart, Standard, 240 V for Export	9
7462	Weck Xenon Light Source Fitting	7
7455	Wolf, Dyonics Light Source Fitting	7
7451	Wolf, Dyonics Scope Fitting	7

CONMED CORPORATION PRODUCT AREAS:

ARTHROSCOPY • ELECTROSURGERY • ENDOSCOPY • ENDOSURGERY • GASTROENTEROLOGY • INTEGRATED SYSTEMS • PATIENT CARE • POWERED INSTRUMENTS • PULMONOLOGY



11311 Concept Boulevard
Largo, FL 33773-4908
(727) 392-6464
Customer Service: 1-800-237-0169
FAX: (727) 399-5256
International FAX: +1 (727) 397-4540
email: customer_service@linvatec.com
www.linvatec.com