

Service Manual

Excalibur *PLUS* **PC**TM
E L E C T R O S U R G I C A L U N I T

English Language Version



LIMITED WARRANTY

For a period of two years following the date of delivery, CONMED Corporation warrants the Excalibur Plus PC™ Electrosurgical Unit against any defects in material or workmanship and will repair or replace (at CONMED's option) the same without charge, provided that routine maintenance as specified in this manual has been performed using replacement parts approved by CONMED. This warranty is void if the product is used in a manner or for purposes other than intended.

This device contains components which will be damaged by static electricity. Proper handling by a grounded person is mandatory. CONMED will provide assistance if needed in safeguard precautions necessary to avoid any question of warranty responsibility

U.S. Patent Nos. 4,437,464 - 4,569,345 -
4,617,927 - 4,848,335 - 4,961,739 - 4,626,575
and other patents pending.

© 1998 CONMED Corporation

310 Broad Street
Utica, New York 13501 U.S.A.

For Technical Service or Return Authorization Phone:
303-699-7600 / 1-800-552-0138 Extension 5274
Fax 303-699-1628

For Customer Service or to order parts phone:
1-800-448-6506 / 315-797-8375 / Fax 315-735-6235
or contact your CONMED Representative.

European Authorized Representative
MDSS GmbH
Burckhardtstr 1
D - 30163 Hannover
Germany

The revision level of this manual is specified by the highest revision letter found on either the inside front cover or enclosed errata pages (if any).

Sections 1 and 2 of this manual duplicate the Excalibur Plus PC® Operator's Manual, Cat. No. 60-6291-ENG.

Manual Number 60-6292-ENG Rev. A

Table of Contents

& List of Illustrations

Section	Title	Page
1.0	GENERAL INFORMATION	1-1
1.1	Cautions	1-1
1.1.1	Cautions For Equipment Preparation	1-1
1.1.2	Cautions For Patient Preparation	1-2
1.1.3	Cautions For Use	1-3
1.1.4	Cautions For Testing or Servicing	1-5
1.2	Specifications	1-6
1.3	Explanation of Symbols	1-8
1.4	Output Characteristic Curves	1-9
2.0	INSTALLATION & OPERATION	2-1
2.1	Initial Inspection	2-1
2.2	Installation	2-1
2.3	Preliminary Checks	2-1
2.3.1	Preliminary Functional Testing	2-1
2.3.2	Preliminary Performance Testing	2-2
2.4	Controls, Displays and Connectors	2-2
2.4.1	Control Panel	2-2
2.4.2	Output Panel	2-4
2.4.3	Rear Panel	2-5
2.5	Operating Instructions	2-7
2.5.1	Preliminary Set Up	2-7
2.5.2	Operation	2-8
2.5.3	Program Mode	2-8
2.5.3.1	Storing Programs	2-9
2.5.3.2	Using Programs	2-9
2.5.4	Remote Power Control Mode	2-9
2.5.4.1	Changing Monopolar Power Remotely	2-9
2.6	User Maintenance	2-10
2.6.1	General Maintenance Information	2-10
2.6.2	Cleaning	2-10
2.6.3	Periodic Inspection	2-10
2.6.4	Periodic Performance Testing	2-10
2.7	In Case of Difficulty	2-10
2.7.1	Return Monitor Alarm	2-10
2.7.1.1	Single Pad Alarm	2-10
2.7.1.2	Dual Pad Alarm	2-10
2.7.2	ACC Faults	2-10
2.7.3	Err Faults	2-11
2.7.4	If All Else Fails	2-11
2.8	Environmental Protection	2-11



Section	Title	Page
3.0	THEORY OF OPERATION	3-1
3.1	Functional Block Diagram Description	3-1
3.2	Power Supplies and Distribution	3-1
3.3	Controller Hardware	3-3
3.3.1	Watchdog Timer (WDT)	3-3
3.3.2	Power On Reset	3-4
3.3.3	Controller, I/O	3-5
3.3.4	Memory	3-5
3.3.5	Base Voltage Generator	3-6
3.3.6	IFAIL DAC	3-7
3.3.7	Waveform Generator	3-7
3.3.8	Tone Generator	3-8
3.3.9	Base Voltage Monitor	3-8
3.3.10	Waveform Monitor	3-8
3.3.11	Tone Monitor	3-9
3.4	Controller Software	3-9
3.4.1	Software Initialization and Test Functions	3-9
3.4.2	Working Program Functions	3-10
3.4.3	CAL Mode Software	3-10
3.4.3.1	Calibration	3-10
3.4.3.2	Diagnostics	3-11
3.4.3.3	Last Fault Code	3-11
3.5	Display Hardware	3-11
3.5.1	Indicators	3-11
3.5.2	Displays and Keyboard	3-11
3.6	Power Amplifier	3-12
3.7	RF Output Section	3-13
3.8	Aspen Return Monitor (A.R.M.) Circuitry and Software	3-13
3.9	Continuity Detector	3-15
3.10	Footswitch Isolation	3-16
4.0	MAINTENANCE	4-1
4.1	General Maintenance Information	4-1
4.2	Assembly Breakdown & Parts Access	4-1
4.2.1	Display PWB A2	4-1
4.2.2	Controller Assembly A3	4-1
4.2.3	Power Conversion Assembly A4	4-2
4.2.4	Output Assembly A5	4-2
4.2.5	Power Transformer and Resonating Capacitor	4-2
4.2.5.1	Primary Strapping	4-2
4.2.5.2	Replacing A9T1 and A6C1	4-2
4.3	Cleaning	4-3
4.4	Periodic Inspection	4-7
4.5	Periodic Performance Testing	4-7
4.5.1	Chassis Ground Integrity	4-7
4.5.2	Displays, Alarms, Commands	4-7
4.5.3	Output Power	4-7
4.5.4	RF Leakage	4-8
4.5.5	RF Leakage From Inactive Outputs	4-9
4.5.6	Line Frequency Leakage	4-10
4.5.7	Aspen Return Monitor (A.R.M.) Calibration Check	4-11



Section	Title	Page
4.5.8	+5 Over Voltage Monitor Check	4-11
4.6	Calibration and Adjustments	4-11
4.6.1	CAL Mode Entry	4-12
4.6.2	CAL Mode Menu	4-12
4.6.2.1	Entering a Mode and Returning to the Menu	4-12
4.6.2.2	Calibrated/Uncalibrated Status	4-12
4.6.2.3	Calibration Limits and Validity Tests	4-13
4.6.2.4	Exiting CAL Mode	4-14
4.6.3	Output Power Calibration Procedure	4-14
4.6.3.1	Monopolar Power Calibration (C-C)	4-15
4.6.3.2	Bipolar Power Calibration (bP)	4-16
4.6.4	A.R.M. Calibration (PAd)	4-16
4.7	Troubleshooting	4-17
4.7.1	Fault Codes	4-17
4.7.1.1	Checking and Clearing Last Fault Code	4-18
4.7.2	Pseudo Run Diagnostics (dIA 2)	4-18
4.7.3	Watchdog Timer Troubleshooting (dIA 1)	4-18
4.7.3.1	Accessing Watchdog Timer Diagnostics	4-19
4.7.3.2	dIA 1 Mode Selection	4-19
4.7.3.3	Troubleshooting with Watchdog Timer (dIA 1)	4-19
4.7.4	Base Voltage Generator Troubleshooting	4-20
4.7.5	Waveform Generator Troubleshooting	4-20
4.7.6	Aspen Return Monitor (A.R.M.) Troubleshooting	4-20
4.7.7	RF Amplifier Troubleshooting	4-21
4.7.8	Power Amplifier Transistor Replacement	4-21
4.7.9	Troubleshooting Resets	4-21
4.7.10	Interference with Other Equipment	4-22
4.8	Parts Ordering Information	4-22
4.9	Parts Lists, PWB Layouts & Schematics	4-22
Appendix A	Fault Codes	A-1

The Table of Contents for Figures, Tables and Schematics is listed on the next page.



Figure	Title	Page
1.1	Output Power vs. Power Setting	1-9
1.2	Display vs Open Circuit Peak Voltage	1-9
1.3	Load Regulation, Monopolar Pure and Blend 1 Cut	1-10
1.4	Load Regulation, Monopolar Blend 2 and Blend 3 Cut	1-11
1.5	Load Regulation, Monopolar Coag	1-12
1.6	Load Regulation, Bipolar	1-13
2.1	Controls, Displays & Connectors	2-6
2.2	Patient Accessory Connections	2-12
2.3	Accessory Schematics	2-13
3.1	Base Voltage Generator Transfer Curve	3-7
3.2	Basic Inverting Break Point Amplifier	3-7
3.3	Basic Hybrid Cascode Configuration	3-12
3.4	Resistance vs. Bar Graph Indicator	3-14
3.5	Power Amplifier Waveforms	3-16
3.6	RF Output Voltage Waveforms	3-17
3.7	Miscellaneous Waveforms	3-20
4.1	Rear Panel Screw Location	4-4
4.2	Display, Controller & Footswitch Isolation PWB Locations	4-5
4.3	Power Conversion & Output PWB Locations	4-6
4.4	A2 Display PWA	4-26
4.5	A3 Controller PWA	4-28
4.6	A4 Power Conversion PWA	4-29
4.7	A5 Output PWA	4-30
4.8	A10 Footswitch Isolation PWA	4-32

Table	Title	Page
4.1	RF Output Power Checks	4-8
4.2	RF Leakage to Ground Tests	4-9
4.3	RF Leakage for Inactive Outputs Test	4-9
4.4	Unkeyed Line Frequency Leakage Tests	4-10
4.5	Keyed Line Frequency Leakage Tests	4-10
4.6	Cal Mode Options	4-13
4.7	dIA 1 Modes	4-19

Schematics	Title	Page
4.0	Functional Block Diagram	4-23
4.1	Interconnect and Power Supply	4-24
4.2	Control Panel	4-25
4.3	Display PWA	4-26
4.4a	Controller PWA, Sheet 1	4-27
4.4b	Controller PWA, Sheet 2	4-28
4.5	Power Conversion	4-29
4.6	Output	4-30
4.7	Mains Voltage and Frequency Variations	4-31
4.8	Footswitch Isolation	4-32



General Information

Section 1.0

This manual provides the set up, operating instructions and servicing information for the Excalibur Plus PCTM. Electrosurgery can be dangerous to patients, staff, and other equipment if misused, therefore, please understand and follow the warnings and cautions that are included in this manual. Technical specifications, various characteristic performance curves, and user maintenance instructions are also included.

The Excalibur Plus PCTM provides a broad range of capabilities in a single general purpose electro-surgical generator. This rugged unit fulfills the operational and safety needs of the modern operating room by providing:

- Four monopolar cutting modes.
- Two monopolar coagulation modes.
- Two bipolar modes.
- RF isolated and independent outputs.
- The proven A.R.M.TM contact quality monitoring system.
- Continuous microprocessor monitoring to provide the safety required by the conscientious user.

Convenience features include:

- Remote Physician Control of power settings using standard hand switched pencils (PC mode).
- Independent power setting for each mode.
- Automatic programming restores unit to the last settings used.
- Easy programmability to speed set up of the unit.

- Controlled output voltage provides superior cut independent of tissue impedance.

- Dual activation in non-contact coagulation modes.

- Ability to change power settings from the control panel while the unit is activated.

1.1 CAUTIONS

This equipment, in conjunction with connected accessories, is intended to produce high-frequency electrical energy for the controlled destruction of tissue.

Safe and effective electrosurgery is dependent not only on equipment design, but also on factors under the control of the operator. It is important that the instructions supplied with this equipment be read, understood, and followed in order to ensure safety and effective use of the equipment.

1.1.1 CAUTIONS For Equipment Preparation

- Use only accessories that meet the requirements of Section 1.2 and Figure 2.3.
- Reusable accessory cables should be periodically function and safety tested in accordance with the original manufacturer's instructions.
- Visually inspect all accessories before each use to verify the integrity of insulation and the absence of obvious defects. In particular, electrode cables and endoscopic accessories should be checked for damage to the insulation.
- The Excalibur Plus PCTM is equipped to connect three monopolar accessories at one time for the convenience of the surgical staff. Unused accessories should be stowed in a safe, electrically insulated place such as a nonconductive holster, isolated from the patient. We recommend that accessories not be connected unless it is known that they will be needed.



- Use only a hospital grade, 3-prong, power cord rated to meet the specifications in Section 1.2 and all of the requirements for safe grounding of the unit. The user should verify that the power receptacle with which this unit is used is properly grounded and correctly polarized, and of the proper frequency per Section 1.2. Do not use ground cheater plugs or extension cords.

- Do not place liquid containers on top of the unit. Wipe spilled liquids off the unit immediately. To preclude inadvertent entry of liquids, do not operate this unit except in its normal position.

- Confirm that all accessories are properly connected to the appropriate jacks.

- Potentially hazardous conditions may exist when accessories of similar connector types are combined. Be certain that accessories are appropriate for the type of generator output used. Use only CONMED/Aspen Labs foot-switches. Confirm bipolar leads are connected only to the bipolar jacks. Connecting bipolar accessories to monopolar outputs may result in patient injury.

- Do not reuse disposable (single use) accessories.

- Do not use cords as handles; damage to the insulation and increased risk of burns or other injury may result.

1.1.2 CAUTIONS For Patient Preparation

- Electrosurgery should NEVER be performed in the presence of flammable anesthetics, flammable prep solutions or drapes, oxidizing gases such as Nitrous Oxide (N₂O), or in oxygen-enriched environments. The risk of igniting flammable gases or other materials is inherent in electrosurgery and cannot be eliminated by device design. Precautions must be taken to restrict flammable materials and substances from the electrosurgical site, whether they are present in the form of an anesthetic, life support, skin preparation agent, or are produced by natural processes within body cavities, or originate in surgical drapes, tracheal tubes, or other materials. There is a risk

of pooling of flammable solutions in body depressions such as the umbilicus and in body cavities, such as the vagina. Any fluid pooled in these areas should be removed before the high frequency surgical equipment is used. Due to the danger of ignition of endogenous gases, the bowel should be purged and filled with nonflammable gas prior to abdominal surgery. To avoid the risk of tracheal fires, never use electrosurgery to enter the trachea during tracheotomy procedures.

- Only non-flammable agents should be used for cleaning and disinfection wherever possible.

- This unit is equipped with the Aspen Return Monitor (A.R.M.) which verifies that the return electrode cable is unbroken and connected to the return electrode and to the electrosurgical unit when in Single Pad mode. It DOES NOT verify that a single pad return electrode is in contact with the patient. When in Dual Pad mode, the A.R.M. confirms that the total resistance is in the preset safety range. Proper application and visual inspection of the return electrode are required for safe operation.

- The use and proper placement of a return electrode is a key element in safe and effective electrosurgery. Follow manufacturer's directions and recommended practices for the preparation, placement, use, surveillance, and removal of any return electrode supplied for use with this electrosurgical unit.

- Apply the return electrode over a well vascularized muscle mass that is thoroughly clean and dry. Clean and shave site as necessary to provide adequate electrical connection and per hospital policy. Avoid placement over scar tissue, bony prominences or other areas where pressure points on small areas might develop.

- Because of the risk of burns, needles should never be used as return electrodes for electrosurgery. The entire area of the return electrode should be placed so that the entire conductive area is in firm contact with an area of the patient's body that has a good blood supply and is as close to the operative site as is possible.



ble. In general, electrosurgical current paths should be as short as possible and should run either longitudinally or in a diagonal direction to the body, not laterally and under no circumstances lateral to the thorax.

- Electrodes and probes of monitoring, stimulating, and imaging devices can provide paths for high frequency currents even if they are battery powered, insulated, or isolated at 50/60 Hz. The risk of burns can be reduced but not eliminated by placing the electrodes of probes as far away as possible from the electrosurgical site and the return electrode. Protective impedances incorporated in the monitoring leads may further reduce the risk of these burns. Needles should not be used as monitoring electrodes during electrosurgical procedures.

- When high frequency surgical equipment and physiological monitoring equipment is used simultaneously on the same patient, any monitoring electrodes should be placed as far as possible from the surgical electrodes. Needle monitoring electrodes are not recommended. In all cases, monitoring systems incorporating high frequency current limiting devices are recommended.

- The active electrode should not be used in the vicinity of electrocardiograph electrodes.

- Heat applied by thermal blankets or other sources is cumulative with the heat produced at the return electrode (caused by electrosurgical currents). Risk of a patient injury may be minimized by choosing a dispersive electrode site that is remote from other heat sources.

- When using injection cannulas as electrocardiograph electrodes, the metal cone must not be placed on the skin; this also applies to the leads to monitoring instruments.

- Electrosurgery by its nature produces significant levels of electromagnetic interference (EMI) when the ESU is activated. This EMI may damage or impair the function of other electronic equipment in the O.R., especially that which makes contact with the patient. Adverse effects can be mitigated by use only of

equipment specifically designed to tolerate electrosurgical interference. Cables subject to flexing should be inspected frequently for shielding integrity.

- The patient should not be allowed to come into contact with metal parts that are grounded, or have an appreciable capacitance to earth. Examples of this would be operating tables, supports, etc. The use of anti-static sheeting is recommended. It is recognized that this recommendation may not be practical during certain procedures (e.g., those in which uninsulated head frames are used); however, to maximize patient safety during the use of electrosurgical devices, such practices should be minimized.

- Skin to skin contacts, such as between the arm and the body of a patient, should be avoided, by the insertion of dry gauze.

- The use of electrosurgery on patients with cardiac pacemakers, pacemaker electrodes, or other active implants is potentially hazardous. The pacemaker may be irreparably damaged and/or the high frequency energy of the electrosurgical output may interfere with the action of the pacemaker. Ventricular fibrillation may occur.

Precautions should be taken to ensure that the patient's well-being is maintained in the event of such interference. We recommend that the Cardiology Department and the manufacturer of the pacemaker be consulted for advice before operating on a patient with a pacemaker. These precautions also apply to operating room personnel with cardiac pacemakers.

- To minimize the possibility of cardiac pacemaker interference, place the return electrode such that the electrosurgical current path is as far as possible from the pacer lead.

1.1.3 CAUTIONS For Use

- PLEASE NOTE: Effective November 29, 1991, federal law (U.S.A.) requires that all healthcare facilities must report to the manufacturer of a medical device, any death or serious injury or illness to a patient related to the



use of a medical device. Serious injuries or illness involving the use of a medical device must be reported to the manufacturer of the device (or to the FDA if the manufacturer of the device is not known) within 10 working days of the incident. Summary reports of such injuries must also be submitted directly to the FDA twice a year. Patient deaths related to the use of a medical device must be reported to the manufacturer and the FDA. For further information, please contact the Regulatory Affairs Department of CONMED Corporation at 800-552-0138, 303-699-7600, or FAX 303-699-9854.

- A failure of the unit could result in an unintended increase in output power.

- Safe and effective electrosurgery is dependent not only on equipment design, but also on factors under the control of the operator. It is important that the instructions supplied with this equipment be read, understood, and followed in order to ensure safety and effective use of the equipment.

- Do not use monopolar electrosurgery on small appendages, as in circumcision or finger surgery, as it can cause thrombosis and other unintended injury to tissue proximal to the surgical site. Please note ANSI/AAMI Standard HF-18-1993 which currently contraindicates both monopolar and bipolar electrosurgery for circumcisions.

Urologic literature also contraindicates the use of monopolar electrosurgery for circumcision, and instead recommends the use of bipolar electrosurgery where clinically indicated for hemostasis. Physicians choosing to use bipolar electrosurgery for circumcisions should be trained in this technique and knowledgeable of the effects of electrosurgery on tissue of this nature.

Should you decide that the bipolar electrosurgical technique is acceptable for circumcision, do not apply the bipolar electrosurgical current directly to circumcision clamps.

- Apparent low power output or failure of the electrosurgical equipment to provide the

expected effect at otherwise normal settings may indicate faulty application of the return electrode, failure of an electrical lead, or excessive accumulation of tissue on the active electrode. Do not increase power output before checking for obvious defects or misapplication. Check for effective contact of the return electrode to the patient anytime that the patient is moved after initial application of the return electrode.

- Studies have shown that smoke generated during electrosurgical procedures may be harmful to surgical personnel. These studies recommend using a surgical mask and adequate ventilation of the smoke using a surgical smoke evacuator or other means.

- If a Dual Pad RETURN Alarm is sounded intraoperatively, physically confirm proper return electrode attachment to the patient prior to pressing the Monitor Set key. Smooth hand over pad surface to ensure electrode contact to patient skin. Replace the pad, if necessary.

- Simultaneous activation can be used in both Standard and Spray monopolar coagulation modes. Caution should be used as the output from either active electrode may change as a result of: activation of a second output, ending activation of an output, or changing the arc length from an output. Power sharing is unlikely to be equal because of differences in tip to tissue distance and other factors. This unequal power sharing can be enough to stop power delivery to one tip if the second tip is close to tissue, and the first tip is somewhat above the tissue. The motion or deactivation of one electrode can cause the other electrode to start delivering power when it had been too far away from tissue to arc before the first electrode change. It is recommended that a second electrosurgical generator be used as a better alternative when it is necessary to perform simultaneous operation.

- Electrosurgical leads (active, bipolar or return) should not be allowed to contact the patient, staff, or other electrical leads connected to the patient.



- The output power selected should be as low as possible and activation times should be as short as possible for the intended purpose.
 - When uncertain of the proper control setting for the power level in a given procedure, start with a low setting and increase as required and/or consult the manufacturer.
 - Observe all caution and warning symbols printed on the cover of the unit.
 - The operating room staff should never contact electrosurgical electrodes (either active or dispersive) while the RF output of the unit is energized.
 - The tips of recently activated accessories may be hot enough to burn the patient or ignite surgical drapes or other flammable material.
 - Do not ignore unexpected activation tones. Check to determine the cause of the tone, otherwise injury can occur.
 - Temporarily unused active electrodes should be stored in an electrically insulated container. The unused active electrode should never be placed on the patient. This is especially important for laparoscopic procedures.
- #### 1.1.4 CAUTIONS For Testing or Servicing
- Service should not be attempted without reference to sections 3 and 4 of this manual.
 - This electrosurgical unit should be tested by qualified maintenance personnel on a periodic basis to ensure proper and safe operation. It is recommended that examination of the unit be performed at least yearly.
 - Refer all servicing to qualified personnel. Your CONMED representative will be happy to assist you in getting your equipment serviced.
 - High voltages are developed within the unit that are accessible when the top cover is removed. These voltages are potentially dangerous and should be treated with extreme caution.
 - The high voltage DC power supply in the Excalibur Plus PC™ is equipped with a bleeder resistor to dissipate the charge on the filter capacitor. However, it takes several seconds after power is removed to bleed that charge down to a safe level; it is recommended that at least thirty (30) seconds be allowed to elapse before touching or attempting to perform any maintenance involving the power supply or power amplifier.
 - Never remove or install any parts with power on.
 - Avoid contact with the output leads when the unit is activated. Periodically inspect the test leads used for the output connections for obvious defects.
 - Although this unit will withstand momentary short circuits on the output, prolonged short circuits may damage the unit. Short circuiting the output should be avoided since it is neither necessary nor desirable.
 - Since the clinical use of electrosurgical units is intermittent in nature with duty cycles on the order of 10%, this unit is not designed to operate for extended periods of continuous output. When testing, it is recommended that duty cycles be limited to 50% with maximum activation times of 30 seconds.
 - Life of the equipment will be extended by minimizing operating temperature and extreme thermal cycles.
 - The heat dissipation capability of the heat sink is impaired by activating the Excalibur Plus PC™ in other than its normal operating position.
 - Ensure that the two top cover screws are tightened, and always perform a power-up check to confirm a normal power-up sequence before returning the unit to service.



1.2 SPECIFICATIONS

INPUT POWER: 700 W max.

Catalog Number & Mains Freq.	Freq. Hz (±1 Hz)	Mains Voltage VRMS			Max Mains Current ARMS		Mains Circuit Breaker Rating
		Nom.	Min.	Max.	Nominal Mains Idle	Max.	
60-6290-120	60	120	104	127	0.8	7.0	10A/120V
60-6290-226	60	220	198	242	0.5	3.8	5A/240V
60-6290-230	50	220-230	198	253	0.5	3.8	5A/240V
60-6290-240	50	240	216	264	0.4	3.5	5A/240V
60-6290-100	50-60	100	90	110	1.0	8.4	10A/120V

MAINS OVERCURRENT PROTECTION:
Combined 2-pole circuit breaker/power switch

MAINS FREQUENCY LEAKAGE:
(Per IEC 601-1)
Patient Connections to Neutral: Less than 10 µA
Chassis to Neutral: Less than 25 µA (120 V)
Less than 45 µA (240 V)

IEC Class I, Type CF, Defibrillator Proof



Non-Ionizing Radiation



REGULATORY CERTIFICATION

UL Listed, Medical and Dental Equipment (E68077)

ISO 9002:1994 Registered Facility



POWER DISPLAY ACCURACY: The greater of +/- 10% of display or +/-3 watts at rated load.

LINE REGULATION: Power change < 1%/V for VLINE = Min to Max Voltage

Duty Cycle: 15s on, 30s idle

ENVIRONMENTAL

Operating Conditions: 10°C to 30°C, 95% RH Non-Condensing maximum

MOUNTING RESTRICTION: 2 inch (5cm) clearance required on each side and above unit for cooling.

COOLING: Natural convection, conduction and radiation. No fan.

Storage Conditions: -40°C to 70°C, altitude -60 to +4500 m MSL when sealed in original poly-bag, packing material and shipping carton.

Prior to shipment or storage, the unit should be enclosed and sealed in a polyethylene bag and placed in original carton using original packaging materials.



RF Leakage:
 <100 mA per IEC 60601-2-2

PAD MONITOR:

SINGLE PAD MODE: Two wire continuity detector, typical threshold = 10 ohms.
DUAL PAD MODE: Two wire resistance monitor, typical acceptance range 10 to 150 ohms, trip threshold typically 20% higher than last MONITOR SET POINT activation, visual indication of patient resistance.

AUDIO SPECIFICATIONS:

Cut = 520 Hz
 Coag = 400 Hz
 Operator Error = 1710 Hz, pulsating
 Plate Alarm = 1000 Hz (65 dbA minimum)
 Machine Fault = 1000 Hz
 (45 dba min. except Alarms are 65 dba min.)

POWER CORD: All units are supplied with an IEC-320 250V 10A 65° C mains inlet connector. The power cord must be ordered separately from CONMED Corp. The appropriate power cord must be rated at a minimum of 250V, 10A, 1.5mm² (#18AWG) Cu.

WEIGHT: 40 lb. 12 oz. (18.5 Kg) 60 Hz Units;
 19.5 Kg (43 lbs.) 50 Hz Units

HEIGHT: 6.25 inches (15.9 cm)
WIDTH: 15.9 inches (40.4 cm)
DEPTH: 22.75 inches (57.8 cm)

**SPECIFICATIONS SUBJECT TO
 CHANGE WITHOUT NOTICE**

















**OPERATING MODES and
 NOMINAL OUTPUT PARAMETERS:**

MODE	MAX POWER (watts)	RATED LOAD (ohms)	TYPICAL CREST FACTOR	MAXIMUM OPEN CIRCUIT VOLTAGE (P-P)	CARRIER FREQ. (KHz)	PULSE REPETITION FREQ. (KHz)
Monopolar						
Pure Cut	300	300	1.7-1.9	1650	416.7	Continuous
Blend 1 Cut	180	300	2.3-2.5	1800	416.7	20.0
Blend 2 Cut	120	300	2.9-3.2	1900	416.7	20.0
Blend 3 Cut	80	300	3.6-4.0	2000	416.7	20.0
Std. Coag	120	300	6.2-6.5	6500	540	40.0
Spray Coag	80	500	8.0-9.0	10000	540	20.0
Bipolar						
Cut	50	50	1.6-1.8	350	1000	Continuous
Coag	50	50	1.5-12.0 (Bipolar Coag crest factor decreases with power setting.)	350	1050	20.0






1.3 EXPLANATION OF SYMBOLS











CONTROL PANEL

-  Pure Cut waveform with minimum thermal damage and hemostasis
-  Blend 1-Cut waveform with moderate hemostasis
-  Blend 2-Cut waveform with heavy hemostasis
-  Blend 3-Cut waveform with maximum hemostasis
-  Standard Monopolar Coagulation
-  Spray Monopolar Coagulation
-  Return Fault Alarm - Monopolar output is disabled
-  Return Electrode Monitor set
-  Resistance - In Dual Pad mode, indicates relative resistance of return electrode contact with the patient
-  Single Pad - Used with electrodes that do not monitor contact quality
-  Dual Pad - Sets monitor to use electrodes that do monitor contact quality
-  Bipolar Coagulation
-  Bipolar Cut
-  Program
-  Program Store
-  Remote Power Control





INTERIOR

-  Replace Fuse only with type and rating as shown
-  Protective Earth (Inlet Connector)
-  High Voltage Circuitry

OUTPUT PANEL



-  Handswitched Output - Connection for handswitched monopolar accessories
-  Footswitched Output - Connection for footswitched monopolar accessories
-  High Voltage Outputs
-  Bipolar Output - Connection for bipolar accessories
-  Handswitched Bipolar Output
-  Footswitched Bipolar Output
-  Type CF - Patient connections are isolated from earth and resist the effects of defibrillator discharge
-  Return Electrode - Connection for monopolar dispersive electrode
-  RF Isolated - Patient connections are isolated from earth at high frequency
-  Consult accompanying documents prior to placing equipment in service

TOP COVER

-  Consult accompanying documents prior to placing equipment in service
-  CAUTION - High Voltage Inside - Refer servicing to qualified personnel
-  Explosion risk if used with flammable anesthetics
-  This equipment intentionally supplies non-ionizing RF energy for physiological effect

IPX1 Enclosure resists entry of vertically falling water

REAR PANEL

-  Equipotential Ground Stud
-  Footswitch Connector



1.4 OUTPUT CHARACTERISTIC CURVES

Figure 1.1 illustrates output power delivered to rated load for all available modes. Figure 1.2 illustrates the maximum peak voltage available at a given power setting and output mode. Section 1.2 specified rated loads and maximum power for each mode, while Figures 1.3 - 1.6 illustrate output power delivered to a range of load resistances for each mode.

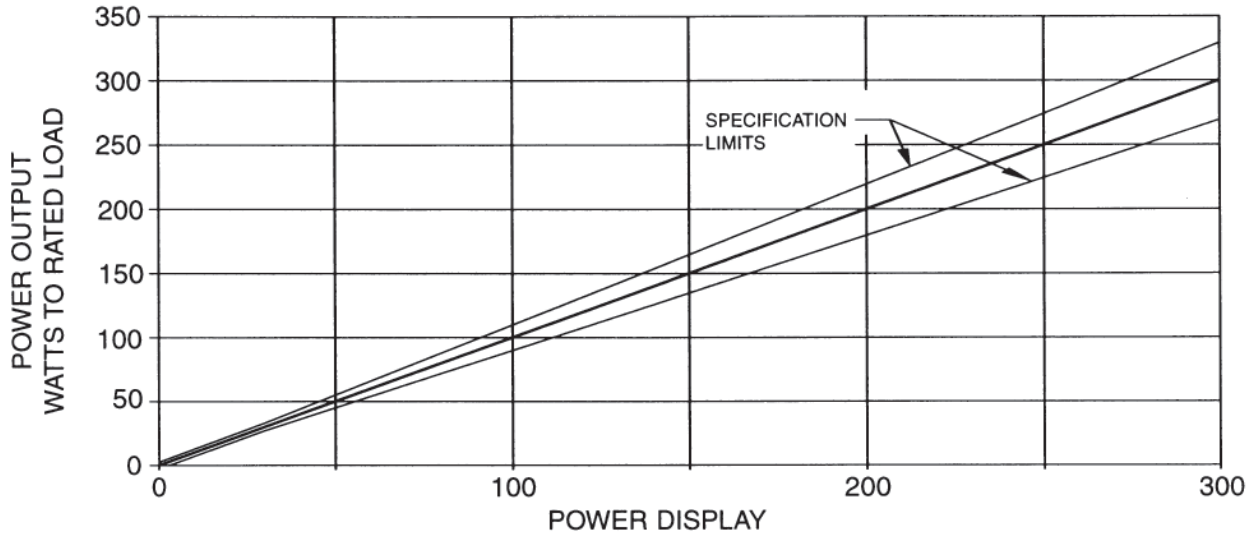


Figure 1.1 Output Power vs. Power Setting

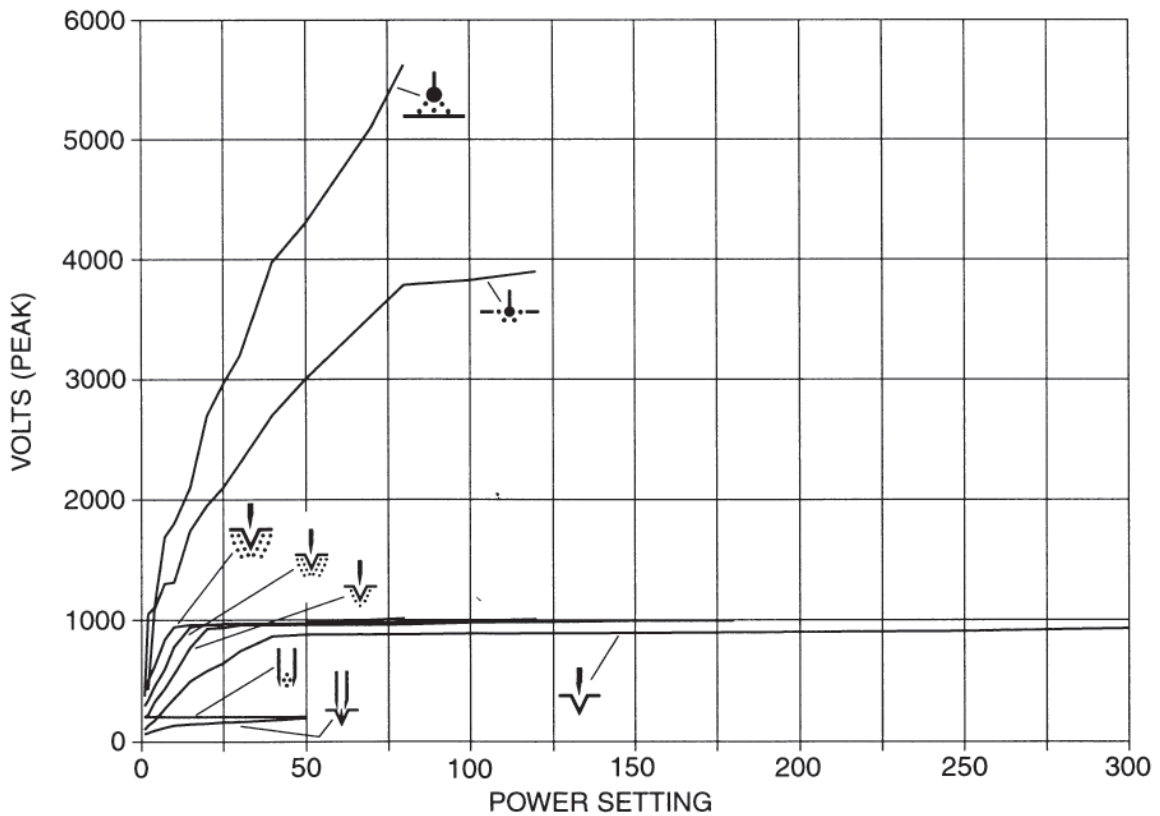


Figure 1.2 Display vs Open Circuit Peak Voltage



Figure 1.3 Load Regulation, Monopolar Pure and Blend 1 Cut

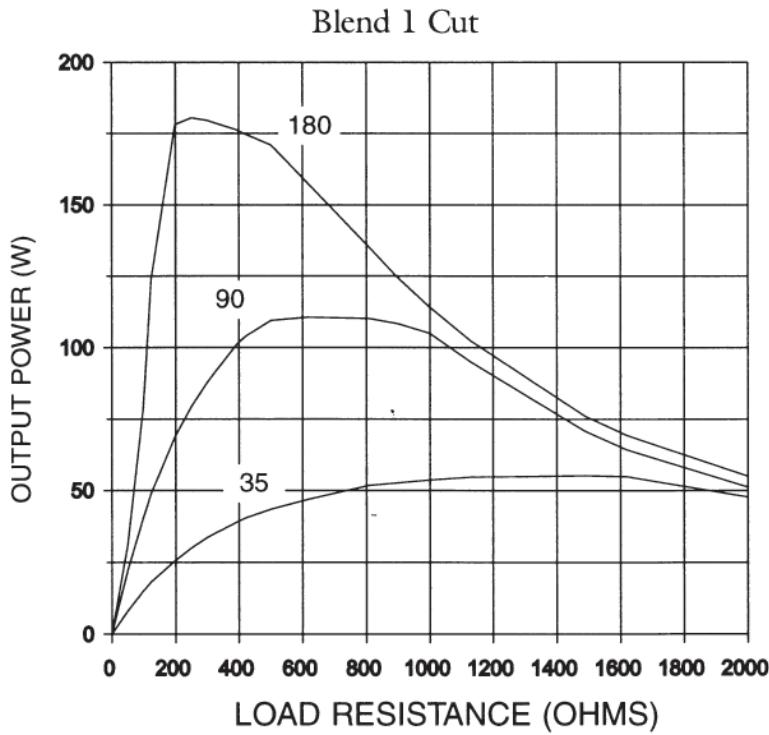
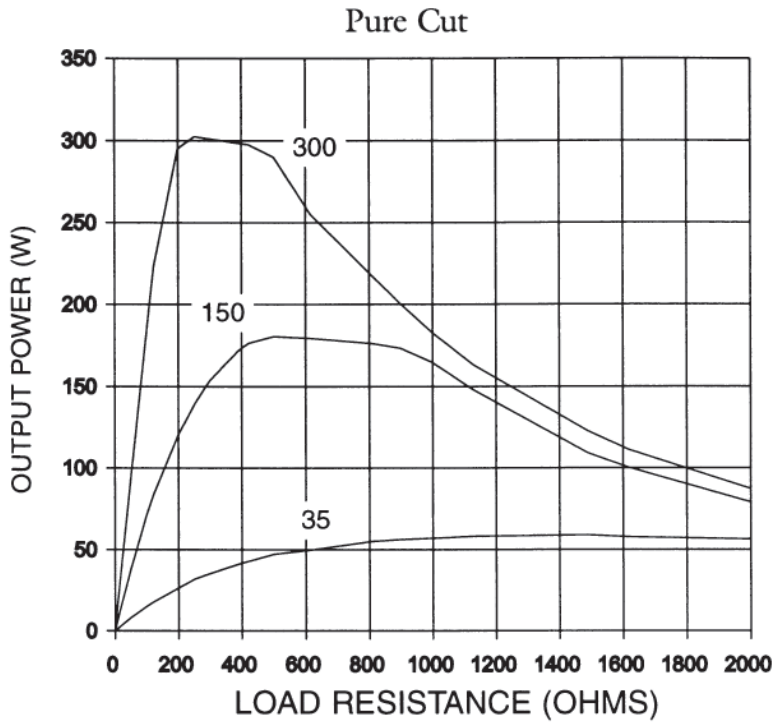


Figure 1.4 Load Regulation, Monopolar Blend 2 and Blend 3 Cut

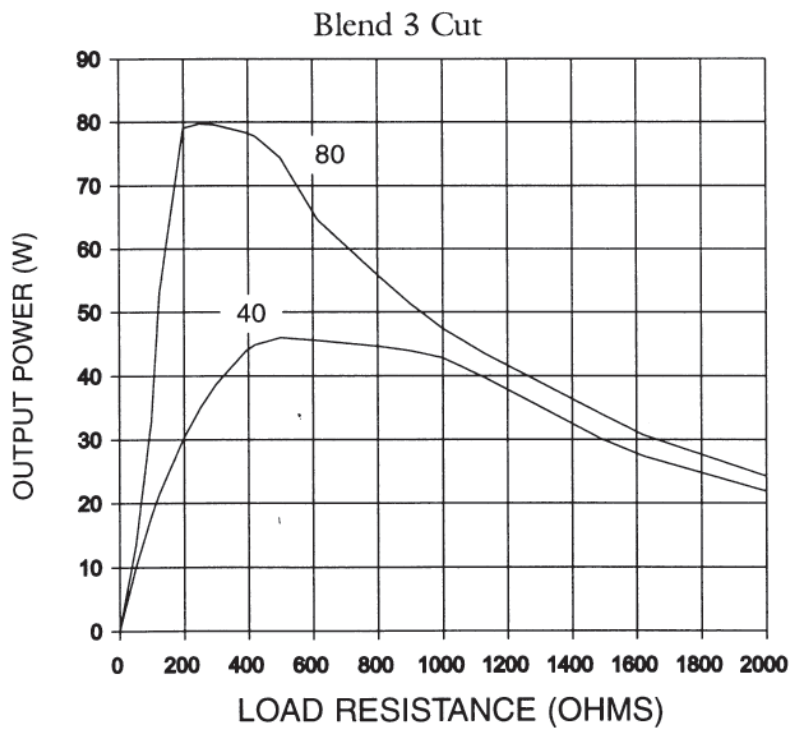
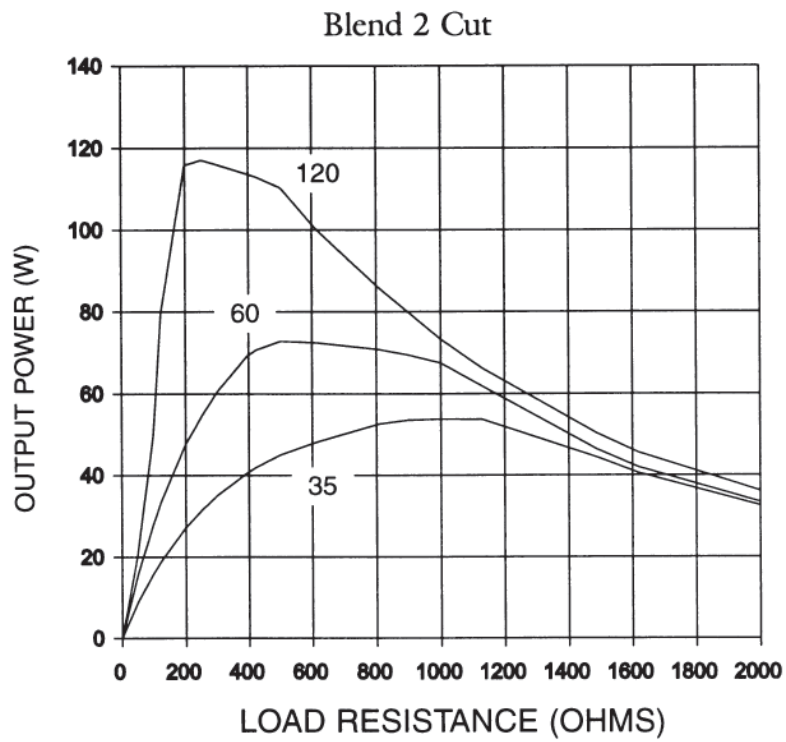


Figure 1.5 Load Regulation, Monopolar Coag

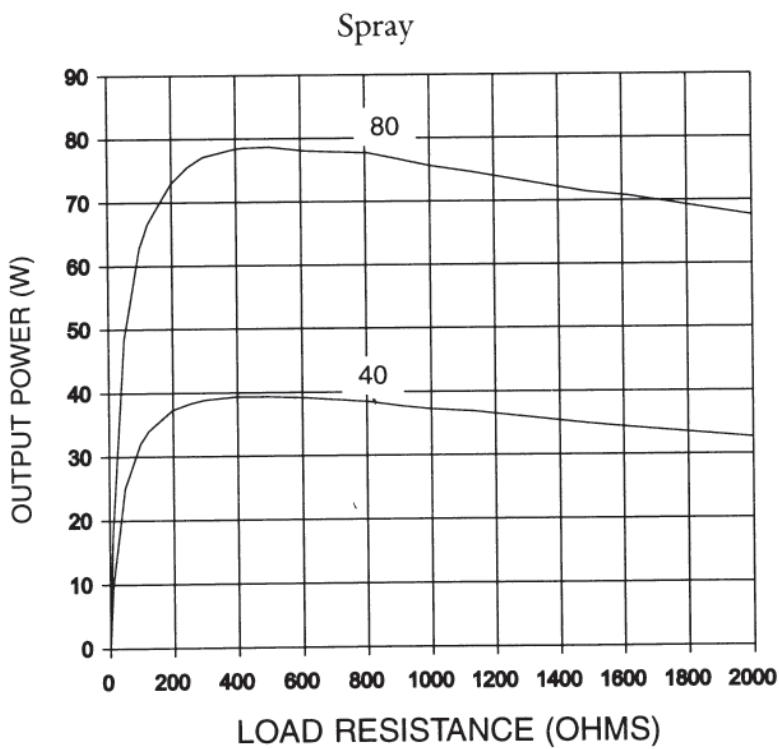
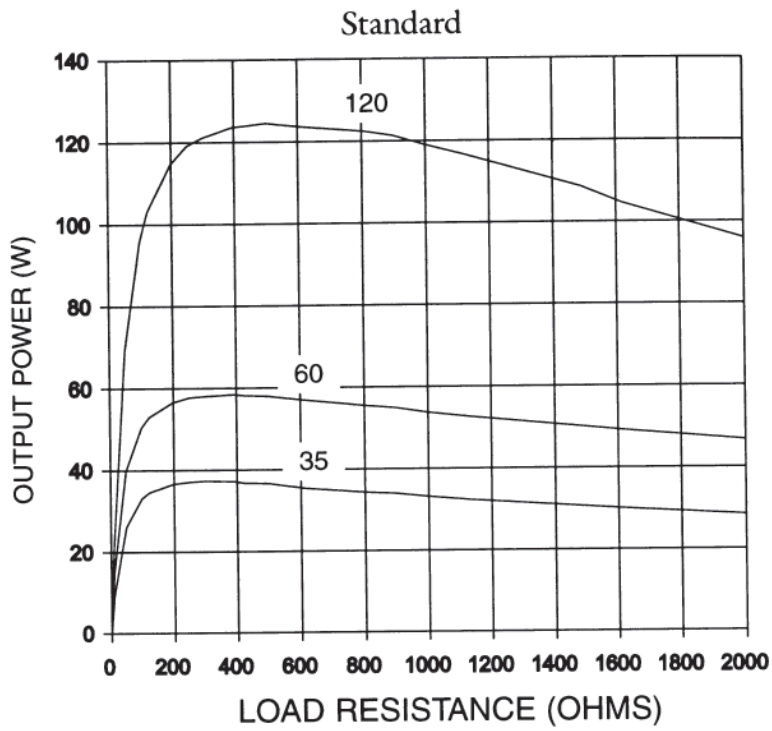
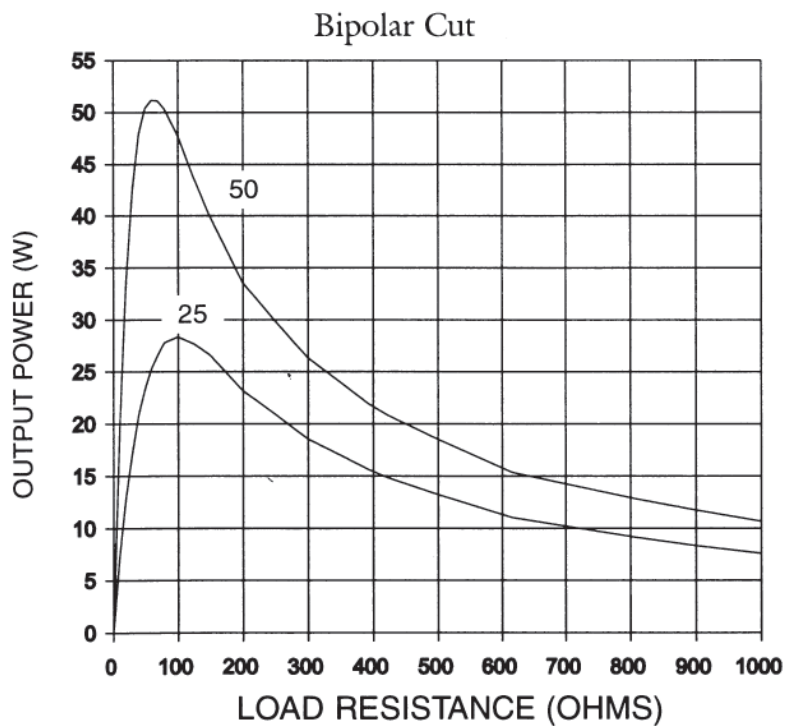
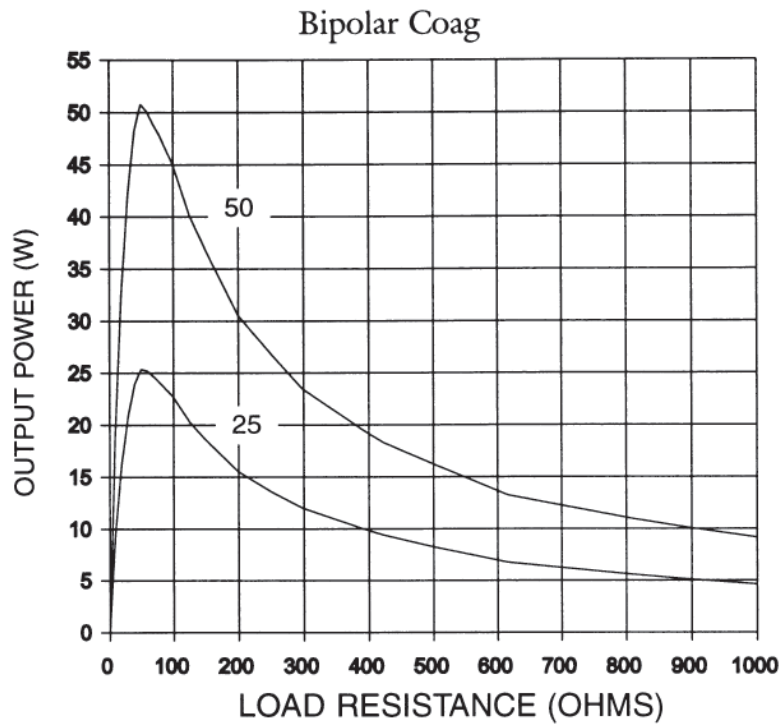


Figure 1.6 Load Regulation, Bipolar





This page intentionally left blank.



Installation & Operation

Section 2.0

This section contains initial installation, preliminary checks and operating instructions for the Excalibur Plus PC™.

2.1 INITIAL INSPECTION

Unpack the unit upon receipt and physically inspect it for any obvious damage that may have occurred during shipment. This inspection should be performed by a qualified biomedical engineer or other person thoroughly familiar with electro-surgical devices. If the unit is found to be damaged, notify the carrier and your CONMED representative immediately.

2.2 INSTALLATION

The unit may be mounted on a matching cart or any stable cart or table.

WARNING

THE POWER CORD OF THE UNIT SHOULD BE CONNECTED TO A PROPERLY POLARIZED AND GROUNDED POWER SOURCE WHOSE VOLTAGE AND FREQUENCY CHARACTERISTICS ARE COMPATIBLE WITH THOSE LISTED ON THE NAMEPLATE OF THIS UNIT.

CAUTION: Since the unit depends on natural convection of air for cooling, it should not be installed in a cabinet or similar enclosure. If mounted on a shelf, or otherwise near a wall, allow a two inch clearance around and above the unit to permit free circulation of air at the sides of the unit.

2.3 PRELIMINARY CHECKS

Prior to initial installation and use of this unit, it is recommended that the performance of the device be tested in this manual. Results of that testing should be compared to the results tabulated on the factory Test Data Sheet that is supplied with each unit. This data should be retained for future reference and comparison.

2.3.1 Preliminary Functional Testing

The following checks are recommended upon initial installation of the equipment and prior to each use of the instrument to avoid unnecessary delays in surgery. See Figure 2.1 for location of controls and connectors.

1. Ensure that the Power Switch is OFF and no accessories are connected.
2. Connect the power cable to a properly grounded and polarized mating power receptacle of the proper voltage and frequency.
3. Connect a two-treadle monopolar foot switch and a single treadle bipolar foot switch to their mating connectors at the rear of the unit. Note: Use only CONMED/Aspen Labs footswitches. Although other types may fit, they may not be compatible.
4. Make no connection to the Return Electrode jacks at this time.
5. Set the Power Switch to the ON position. The green lamp in the power switch shall illuminate. As the unit goes through its internal self-diagnostics, the machine should respond by:
 - a) Sounding a tone test.
 - b) During the tone test, displaying a total of nine "8"s on the four digital displays.
 - c) Illuminating all three mode indicators, all twelve key indicators, Return Fault indicator, and all of the ASSIST Resistance indicator bars.
 - d) After the display test, the unit will show SLF dIA (for self-diagnostics) nn X, where nn is the last 2 digits of the software part number, and X is the software revision level. The unit is conducting a power-on self test during this interval.



6. Depress the Cut treadle of the monopolar foot switch. The Return Alarm tone should sound and Return Fault should continue to glow. While holding the Cut treadle, rotate the volume control over its full range and verify there is no significant change in sound level. Release the Cut foot switch and the tone should stop.

7. Verify that each of the following modes can be selected and adjusted up and down, and that no other displays are affected:

- Pure Cut
- Blend 1 Cut
- Blend 2 Cut
- Blend 3 Cut
- Standard Coag
- Spray Coag
- Bipolar Coag
- Bipolar Cut

Return all power settings to desired setting.

8. Select Bipolar Coag and depress the bipolar foot switch. Confirm that the Bipolar Mode indicator illuminates, and a coag activation tone is sounded. While still depressing the bipolar foot switch, rotate the Sound Volume Control over its full range to verify the function of that control and that sound is audible at all positions. This control may be left at any desired position. Confirm that releasing the bipolar foot switch returns the Excalibur Plus PC™ to its idle state. Verify that the bipolar hand switch control is functional by use of the appropriate forceps or by connecting a jumper between the center and bottom Bipolar Output jack on the Output Panel. The effect will be identical to depressing the Bipolar foot switch.

9. Press the Single Pad Select key to select Single Pad mode and confirm that no ASSIST Resistance indicator bars are lit, and the Return Fault indicator remains lit. Connect a single pad Return electrode to the Return electrode jack. Confirm the Return Fault indicator goes out.

10. Depress the Cut treadle of the Monopolar foot switch. The yellow Cut Mode indicator shall light and the cut activation tone shall sound.

11. While continuing to press the Cut treadle of the foot switch, depress the Coag treadle. An

operator error tone shall sound. Release the Cut treadle, continue to press the Coag treadle and confirm that the tone changes to the coag activation tone, and the blue Coag Mode indicator is illuminated until the Coag treadle is also released.

12. Connect a handswitching active electrode to the Monopolar Accessory Jack #1. Activate, one at a time, the Cut and Coag hand switch controls verifying that each control causes the correct indicator and tone to sound. Move the handswitching active electrode to the Monopolar Accessory Jack #2 and repeat.

13. Remove the two wire, single pad return electrode, and confirm that the Excalibur Plus PC™ beeps twice, and the Return Fault indicator illuminates.

2.3.2 Preliminary Performance Testing

After the unit passes the Preliminary Functional Tests of Paragraph 2.3.1, preliminary performance testing may be conducted. Such testing is best carried out by use of an electrosurgical generator tester, as described in this manual. Note that the power display of the tester will be most accurate when a noninductive resistor of the rated generator output impedance for the selected mode is used.

If no tester is convenient, the availability of therapeutic current may be ascertained subjectively by attempting to cut and coagulate on surrogate tissue such as a piece of meat or fresh fruit, a wet bar of soap, or a sponge moistened in saline.

2.4 CONTROLS, DISPLAYS AND CONNECTORS

The numbers preceding the following paragraphs correspond to the numbered items in Figure 2.1.

2.4.1 Control Panel

All controls except for the sound volume control and the power circuit breaker are located on the control panel. Refer to the CONTROL PANEL portion of Fig. 2.1.



1. MONOPOLAR CUT MODE INDICATOR:

This yellow lamp lights when the unit is keyed in a monopolar cut mode.

2. MONOPOLAR CUT POWER DIGITAL DISPLAY:

Indicates the cutting power level selected in the currently selected monopolar cut mode.

3,4. MONOPOLAR CUT POWER ADJUSTMENT KEYS: Adjusts the output power level of the selected cut mode.

5. MONOPOLAR COAG MODE INDICATOR:

This blue lamp lights when the unit is keyed in a monopolar coagulation mode.

6. MONOPOLAR COAG POWER DIGITAL DISPLAY:

Indicates the power level set in the currently selected monopolar coagulation mode.

7,8. MONOPOLAR COAGULATION POWER ADJUSTMENT KEYS:

Adjusts the output power level of the selected Coag mode.

9. RETURN FAULT INDICATOR:

Illuminates when the unit detects a problem in the return electrode circuit. In Dual Pad mode, the indicator will illuminate when the Monitor Set Point has not been set, or a return electrode cable is open or shorted, or the type of return electrode used does not match the type selected, or when patient resistance is out of range. In Single Pad mode, it will illuminate if either of the return electrode cables is open. In addition, a return fault tone will sound when a Return fault is detected for either type of electrode and a monopolar activation is attempted. The unit will not produce monopolar energy when this indicator is illuminated.

10. MONITOR SET INDICATOR: Flashes when Dual Pad is selected and A.R.M. is in range, but Monitor Set is not pressed yet. After Monitor Set is pressed, light goes out.

11. MONITOR SET POINT KEY: Push when in the Dual Pad mode after a dual pad electrode has been properly applied to the patient and connected to the unit. Pressing this key notifies the unit that the present return circuit resistance represents safe return electrode placement and causes

the ASSIST Resistance indicator (28) to stop flashing if the patient's resistance is within the acceptable range (see ASSIST Resistance indicator).

12. BIPOLAR MODE INDICATOR: This lamp lights when the unit is keyed in either of the bipolar modes.

13. BIPOLAR POWER DIGITAL DISPLAY:

Indicates the bipolar power level set via the Bipolar Power Level Controls in the currently selected Bipolar modes.

14,15. BIPOLAR POWER ADJUSTMENT KEYS:

Adjusts the output power level of the selected Bipolar mode.

16. PROGRAM LOCATION INDICATOR:

Shows "P" for previous, "0" for zero power settings, or 1-9 for user programmable settings.

17,18. PROGRAM LOCATION SELECTION KEYS:

Press these keys to scroll to desired program location.

19. STORE KEY: Pressing this key will store the present settings at the program location indicated, except for the "P" or "0" indicators.

20. BIPOLAR COAGULATION MODE INDICATOR:

Illuminates when Bipolar Coagulation mode has been selected.

21. BIPOLAR COAG SELECT KEY:

Selects Bipolar Coagulation mode.

22. BIPOLAR CUT MODE INDICATOR:

Illuminates when Bipolar Cut mode has been selected.

23. BIPOLAR CUT SELECT KEY:

Selects Bipolar Cut mode.

24. DUAL PAD SELECT:

Is pressed to select Dual Pad return electrode mode.

25. DUAL PAD MODE INDICATOR:

Illuminates when the DUAL pad return electrode mode has been selected.



26. **SINGLE PAD SELECT KEY:** Pressing this key will select the Single Pad return electrode mode.

27. **SINGLE PAD INDICATOR:** Illuminates when the SINGLE pad electrode mode is selected.

28. **ASSIST RESISTANCE INDICATOR:** This green LED bar graph is a visual indicator of patient resistance measured between the contacts of the return electrode. The number of green bars illuminated increases with increasing resistance and may be used as an aid in detecting high risk patients. The ASSIST Resistance indicator will flash if the Excalibur Plus PC™ is in Dual pad mode and the Monitor Set Point (11) has not been properly established (see Monitor Set Point Key). The ASSIST Resistance indicator will light 2 to 8 bars when the patient's return electrode resistance is within range.

29. **STANDARD COAG SELECT KEY:** Pressing this key will select Standard Coag mode.

30. **STANDARD COAGULATION MODE INDICATOR:** Illuminates when Monopolar STANDARD Coagulation mode has been selected.

31. **SPRAY COAG SELECT KEY:** Pressing this key will select Spray Coag mode.

32. **SPRAY COAGULATION MODE INDICATOR:** Illuminates when Monopolar SPRAY Coagulation mode has been selected.

33. **BLEND 1 CUT SELECT KEY:** Pressing this key will select the Blend 1 cut mode

34. **BLEND 1 CUT INDICATOR:** Illuminates when Blend 1 is selected.

35. **BLEND 3 CUT SELECT KEY:** Pressing this key will select the Blend 3 cut mode.

36. **BLEND 3 CUT INDICATOR:** Illuminates when Blend 3 is selected.

37. **BLEND 2 CUT SELECT KEY:** Pressing this key will select the Blend 2 cut mode.

38. **BLEND 2 CUT INDICATOR:** Illuminates when Blend 2 is selected.

39. **PURE CUT SELECT KEY:** Pressing this key will select the Pure cut mode.

40. **MONOPOLAR PURE CUT MODE INDICATOR:** Illuminates when Pure mode has been selected.

41. **REMOTE POWER SELECT KEY:** Pressing this key will select the Remote Power Mode if not selected and will deselect the Remote Power Mode if selected.

42. **REMOTE POWER SELECT INDICATOR:** Illuminates when the Remote Power Mode is selected.

2.4.2 Output Panel

The output panel contains the power circuit breaker and the required patient connection jacks for electrosurgery. Refer to the OUTPUT PANEL portion of Fig. 2.1.

1. **CIRCUIT BREAKER:** Primary power switch for the unit; turns unit on and off. Also provides double-pole power line overload protection.

2 & 3. **HAND SWITCHABLE MONOPOLAR ACCESSORY JACKS:** Two independent sets of color coded banana jacks are provided for the connection of hand switched monopolar accessories. Hand switchable monopolar coagulating forceps may be used by connecting to the red and lower black jacks. These jacks may be activated only by the accessories connected to them.

4. **FOOT SWITCH CONTROLLED MONOPOLAR ACCESSORY JACK:** This jack accepts accessory cables or adapters equipped with standard active (Bovie #12) plugs. This jack can be activated only by the monopolar foot switch.

5. **TWO-PIN RETURN ELECTRODE JACK:** This jack accepts a standard two-pin return electrode plug.



6 & 7. BIPOLAR ACCESSORY JACKS: Bipolar output, activated by the bipolar foot switch or by hand switchable bipolar accessories.

8. BIPOLAR SWITCH JACK: Hand switchable bipolar accessories must be connected such that the hand switch contacts are connected between this black miniature banana Bipolar Switch Jack and the lower blue Bipolar Accessory Jack (6).

2.4.3 Rear Panel

The rear panel contains the foot switch connectors, power cord connector, volume control and carrying handle/cord wrap. Refer to the REAR PANEL portion of Fig. 2.1.

1. CARRYING HANDLE

2. MONOPOLAR FOOT SWITCH CONNECTOR: This 4-pin threaded connector is designed to accept plugs attached to any two treadle monopolar foot switch available from CONMED/Aspen Labs. Use only CONMED/Aspen footswitches. Other manufacturer's footswitches may not be compatible.

3. BIPOLAR FOOT SWITCH CONNECTOR: A 3-pin threaded connector designed to accept any CONMED/Aspen Labs single-treadle bipolar foot switch.

4. SOUND VOLUME CONTROL: Controls the volume of the sound tones produced during normal activation of the unit. Clockwise rotation increases the volume. It does not affect volume of alarm tones.

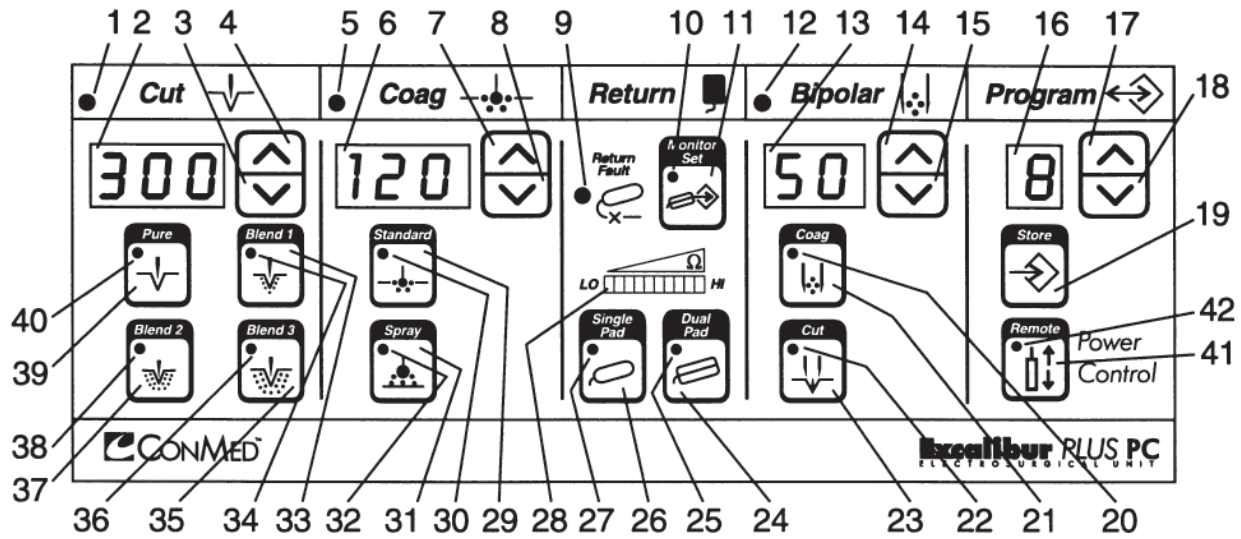
5. EQUIPOTENTIAL GROUND CONNECTION: Chassis ground connection suitable for attachment of standard auxiliary grounding cable when required for additional protection against low frequency risk current.

6. POWER INLET: Supplies ac mains power to the unit. It only should be connected to a source of power corresponding to that listed on the nameplate.

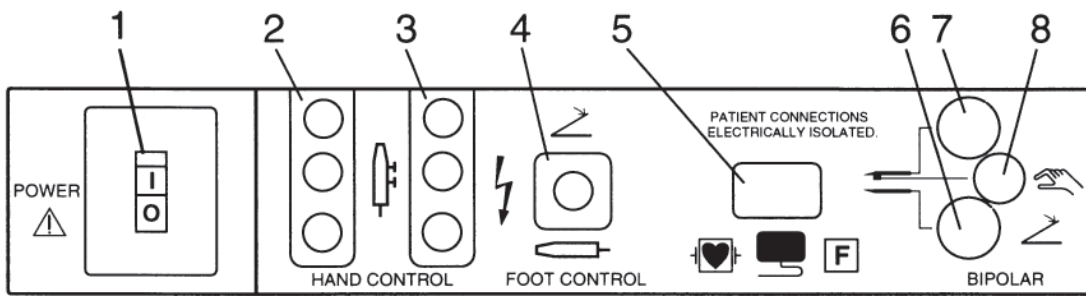
7. NAMEPLATE: Specifies model name, serial number, nominal line voltage, frequency, current, power consumption and rated duty cycle.



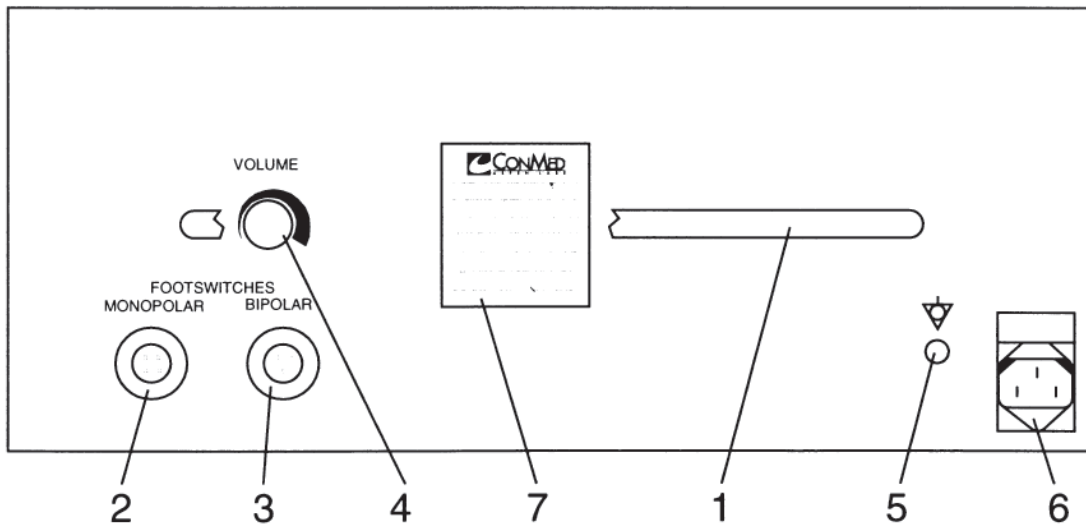
Figure 2.1 Controls, Displays & Connectors



CONTROL PANEL



OUTPUT PANEL



REAR PANEL



2.5 OPERATING INSTRUCTIONS

2.5.1 Preliminary Set Up

1. Ensure the Power Switch is OFF, then connect the power cable to a properly grounded and polarized mating power receptacle. Do not connect a Return electrode at this time.

2. Set the Power Switch to the ON position. The green lamp in the Power Switch shall illuminate. As the unit goes through its internal self-diagnostics, confirm the machine responds by:

a) Sounding a tone test.

b) During the tone test, displaying a total of nine "8"s on the four digital displays.

c) Illuminating all three mode indicators, all twelve key indicators, Return Fault indicator, and all of the ASSIST Resistance indicator bars. After the display test, the unit will show SLF dIA (for self-diagnostics) in the cut and coag power windows. The bipolar power window will show the software part number and the program window will show the software revision level.

d) After the power-on self-tests are complete, the unit should beep the "test completed" tones.

After the power-on self-tests, the unit is ready for use. If the unit sounds a continuous high tone, displays a fault code, or otherwise fails to respond as above, the unit has failed one of its internal tests and is not suitable for use. Before turning the power off, note the "Err" or "ACC" code displayed in the Power Displays to assist in the diagnosis by a biomedical technician. ACC codes can often be corrected by Operating Room staff, see Section 2.7.2. Contact your Biomedical department for repair if an "Err" code appears.

3. Inspect, then connect the desired monopolar accessories to connectors. Refer to Figure 2.2 for typical monopolar accessory connections.

WARNING
ALWAYS STOW UNUSED ACCESSORIES
IN A SAFE, INSULATED LOCATION
SUCH AS A HOLSTER.

4. Connect the foot switches, as required, to the rear of the unit (not required if only hand switchable accessories are to be used). Use only CONMED/Aspen Labs footswitches.

5. Inspect, then connect the plug of the dispersive electrode cable to the return electrode jack or to an appropriate adapter. Refer to Figure 2.2. A dispersive electrode need not be connected if only Bipolar operation is required.

NOTE: This electrosurgical unit incorporates the Aspen Return Monitor. The monitor will inhibit monopolar operation of the unit if its requirements for the return electrode have not been satisfied (see instruction 7).

6. Select and prepare the patient return electrode site and apply the return electrode in full contact with the patient, and in accordance with the manufacturer's instructions. If no instructions are given, observe the guidelines provided in Section 1 of this manual.

7. Generally, the return pad type will already be set to the proper mode, since the unit automatically retains the last pad setting. If it is incorrect, select Dual Pad or Single Pad Mode. Confirm that the ASSIST Resistance indicator and the Return Fault Indicator are blank if Single Pad mode is selected. If Dual Pad mode is selected, press the Monitor Set Point key only after visually confirming full dual pad electrode contact with patient. Confirm the Return Fault indicator is blank, and the ASSIST Resistance indicator stops flashing and displays 2 to 8 green bars. The number of green bars indicates the patient's resistance and can be used as an indicator of patient risk.

WARNING
DO NOT DEPEND SOLELY ON THE
ASSIST RESISTANCE INDICATOR FOR
CONFIRMATION OF GOOD RETURN
ELECTRODE APPLICATION.
QUALIFIED PERSONNEL SHOULD
MAKE THE FINAL DECISION ON
PROPER ELECTRODE PLACEMENT.

8. The machine may already be setup to desired settings, since it powers up to the last settings at the time the unit was powered down. If not, but the desired settings have been programmed, use



the Program select keys to scroll to the desired program location. Refer to Section 2.5.3 for details on programming. At this point, the unit is ready for operation. Otherwise, continue setup instructions below.

CAUTION: Confirm the Program settings are correct before using.

9. Set the Monopolar Cut Mode to Pure for cutting or one of three Blend Modes for desired cutting with hemostasis.
10. Set the Monopolar Coag Mode to STANDARD to provide pinpoint hemostasis or to SPRAY to provide fulguration.
11. Select the desired Bipolar mode.
12. Adjust the CUT, COAG, and BIPOLAR power level controls to the desired levels. If unsure of the proper settings, use low power settings initially and make adjustments intraoperatively according to the surgeon's requests. Use of program mode or a written record of each surgeon's preferred power setting for various procedures will expedite subsequent pre-op setup.

2.5.2 Operation

Activate the electro-surgical unit in the desired operating mode by depressing the appropriate treadle of the foot switch or switch of a hand switching accessory. Adjust the corresponding power level until the desired surgical effects are obtained. Remember that power setting changes are limited when the unit is keyed. The available power in watts will be displayed on the digital display corresponding to activation mode. Noting this wattage may be useful in attempting to derive similar surgical effects from several machines of different manufacturers. The surgical effects obtained are dependent on a number of factors including waveform, electrode size, electrode geometry, power level and surgical technique.

The size and geometry of monopolar electrodes are significant in that a large electrode, absent of sharp features (e.g., a ball electrode) will have no tendency to cut, regardless of the waveform power level. Conversely, a small, sharp electrode, such as a needle or wire loop, will be likely to cut simply from mechanical pressure.

The activation mode is selected by the user via hand or foot switch and the setting of the active Mode Select switch.

The Bipolar Coagulation waveform is designed to minimize tissue sticking and popping by limiting the output voltage regardless of power setting. Bipolar hemostasis is more localized than in monopolar, since only the tissue grasped between the forceps tips is affected. This is particularly desirable in vascular surgery, where monopolar current may concentrate in the affected vessel and result in undesired tissue effects. This easily controlled localization is also of benefit in plastic surgery and neurosurgery.

The Bipolar Cut waveform is essentially identical to that for monopolar Pure cut, but is delivered at a lower voltage and higher frequency.

2.5.3 Program Mode

Up to 9 complete mode and power settings can be easily stored and recalled at any time. Additionally, there are two settings that the unit automatically sets, "P" and "0" (zero).

The unit automatically stores the most recent settings at power down and will restore those settings when the unit is turned ON. A "P" (for Previous) will be displayed in the Program Location Indicator. Note that if a power loss occurs during activation, the values stored in the "P" location will be those just prior to the activation.

The "0" (zero) location sets all power settings to zero, and the activation modes to Pure Cut, Standard Coag and Bipolar Coag. The pad mode will remain at the last setting. The settings 1-9 contain user stored settings.



2.5.3.1 Storing Programs

1. Select the desired storage location BEFORE setting the desired modes and power settings. As each location is shown, the displays will indicate the contents of that location.
2. Set the modes, power and pad settings as desired. Note that non-displayed mode settings are also stored at this time.
3. Press the STORE key. If a correction is needed, simply set the machine as desired and press STORE again.

2.5.3.2 Using Programs

Select the stored setting location by using the PROGRAM SELECTION keys. Confirm the program settings are correct before using.

2.5.4 Remote Power Control Mode

CAUTION: The Remote Power Control feature should be enabled only if the surgeon is familiar with its operation and requires its capabilities. The power displays should be monitored for expected effect while Remote Power Control adjustments are being performed until normal operation is restored.

The Remote Power Control may only be activated when the Remote Power Select Indicator is on. This mode may be selected or deselected with the Remote Power Select Switch, and the status of the Remote Power Control Mode may be stored as per Section 2.5.3 Program mode. The Remote Power Control Mode will always be off after power up (i.e., "P" will be displayed in the Program Location Indicator).

2.5.4.1 Changing Monopolar Power Remotely

1. Select Remote Power Control.
2. Double click CUT button on the pencil to adjust the cut power or double click COAG button to adjust the coag power.
3. A loud acceptance tone will sound, allowing power adjustments only from the pencil that the double click was detected.

4. The Power Indicator for the associated power adjustment selected will flash.
5. Only the Remote Power Select Key on the front panel will be functional.
6. Depress CUT to increase power or depress COAG to decrease power. An audible tone will sound for each power increment change.
7. The first activation for a power increase will sound an intermediate tone to a higher tone.
8. The first activation for a power decrease will sound an intermediate tone to a lower tone.
9. Between 0 and 20 watts, a short up or down tone will sound with each one watt step.
10. At greater than 20 watts, a short up or down tone will sound with each five watt step. Should the switch be held for more than 4 successive five watt steps, the power adjustment will be accelerated and a continuous up or down tone will sound. Releasing the switch and pressing will once again start the five watt step. Note that the 5 watt increment will be calculated on the power display when the switch is not depressed.
11. The associated Power Indicator will not flash during the period of adjustment.
12. To end power adjust:
 - a. Double click either CUT or COAG.
 - OR-
 - b. Turn off Remote Power Control Mode.
 - OR-
 - c. Do not press CUT or COAG buttons for 6 seconds for time out.
13. A loud acceptance tone will sound, returning control for normal operation. See Section 2.5.2 Operation.



2.6 USER MAINTENANCE

2.6.1 General Maintenance Information

This section contains information for ordinary upkeep of the Excalibur Plus PC™. While the unit has been designed and manufactured to high industry standards, it is recommended that periodic inspection and performance testing be performed by a qualified biomedical technician to ensure continued safe and effective operation.

2.6.2 Cleaning

The exterior of the unit may be cleaned by wiping it with a cloth that has been dampened (not dripping) with a mild detergent such as Windex® or Formula 409®. Windex® is the registered trademark of the Drackett Products Company. Formula 409® is the registered trademark of the Clorox Company.

2.6.3 Periodic Inspection

The Excalibur Plus PC™ should be visually inspected at least every year. This inspection should include checks for:

- Damage to the power cord.
- Damage to the power plug.
- Tightness of the power plug.
- Tightness of the volume control knob.
- Proper mating, cleanliness and absence of damage to the patient connectors.
- Obvious external or internal damage to the unit.
- Accumulation of lint or debris within the unit or heatsink.

2.6.4 Periodic Performance Testing

The Excalibur Plus PC™ should be performance tested at least every year. Each unit is supplied with a serialized Product Test Data Sheet which tabulates the results of the factory tests that were performed on the unit. This data may be used as a reference for subsequent tests and should be made available to the biomedical technician conducting the tests.

2.7 IN CASE OF DIFFICULTY

2.7.1 Return Monitor Alarm

Trouble with the Return Pad is signalled by illumination of the Return Fault Indicator. Activation attempts will result in an audible fault alarm. Replace Pad if any patient contact has been lost, and press the Monitor Set key to store the new resistance for Dual Pad mode.

2.7.1.1 Single Pad Alarm

If a Single Pad Alarm condition exists, confirm that a single pad is attached to the unit. Check all Return Pad cable connections and replace pad or cable if necessary.

2.7.1.2 Dual Pad Alarm

If a Dual Pad alarm exists, check the ASSIST bar graph for clues to the problem.

- All of the bars are flashing, the resistance is too high. This can be caused by inappropriate pad site, a broken cable, or poor connections to the unit.
- More bars are flashing than originally were when Monitor Set was pressed. Check to see if the pad has peeled from the patient or if the unit has a poor connection.
- No bars are on. Check to see if a single pad has been connected instead of a dual pad. Confirm a dual pad is not connected to something highly conductive or folded over on itself.



2.7.2 ACC Faults

ACC Codes are most often caused by faults in accessories attached to the unit. Often the fault can be corrected in the operating room without a service call. The following list gives the meaning of each code, and what to check. For each code, check to see that the switch, panel or accessory is not being pressed while the unit is powering up. Turn unit off, unplug accessory, then turn unit back on. If the code still shows, call service.

ACC Code	What to check
FS	Monopolar Foot Switch shorted (Ensure Foot Switch treadle is not depressed.)
LH	Left Hand monopolar accessory shorted
rH	right Hand monopolar accessory shorted
bP	biPolar accessory shorted
*CPxx	Control Panel key stuck

*Note: "xx" displayed in the bipolar window corresponds to the stuck key using figure 2.1 as a reference. Multiple keys show as "88".

2.7.3 Err Faults

Err Code faults generally cannot be corrected in the operating room and require a repair technician. Occasionally, turning the unit off and back on will clear an Err fault and resume normal operation of the unit.

2.7.4 If All Else Fails

Contact CONMED Corporation Technical Services at the phone or fax numbers listed on the inside front cover of this manual. Please have the model and serial numbers from the rear panel nameplate along with a description of the problem, including power settings, accessories in use, and fault code.

2.8 ENVIRONMENTAL PROTECTION

The shipping container and packing material should be retained in the event the unit must be returned for factory service. At the end of the equipment's life, it should be disposed of in accordance with your local regulations. Component materials are:

- Aluminum enclosure and heatsinks.
- Unit front handle is steel.
- Thermoset printed wiring boards containing miscellaneous electronic components.
- Power transformer made of steel and copper.
- Mains cord made of thermoplastic and copper.
- Shipping container is cardboard; packing materials are a combination of Urethane foam and Polyethylene film.



Figure 2.2 Patient Accessory Connections

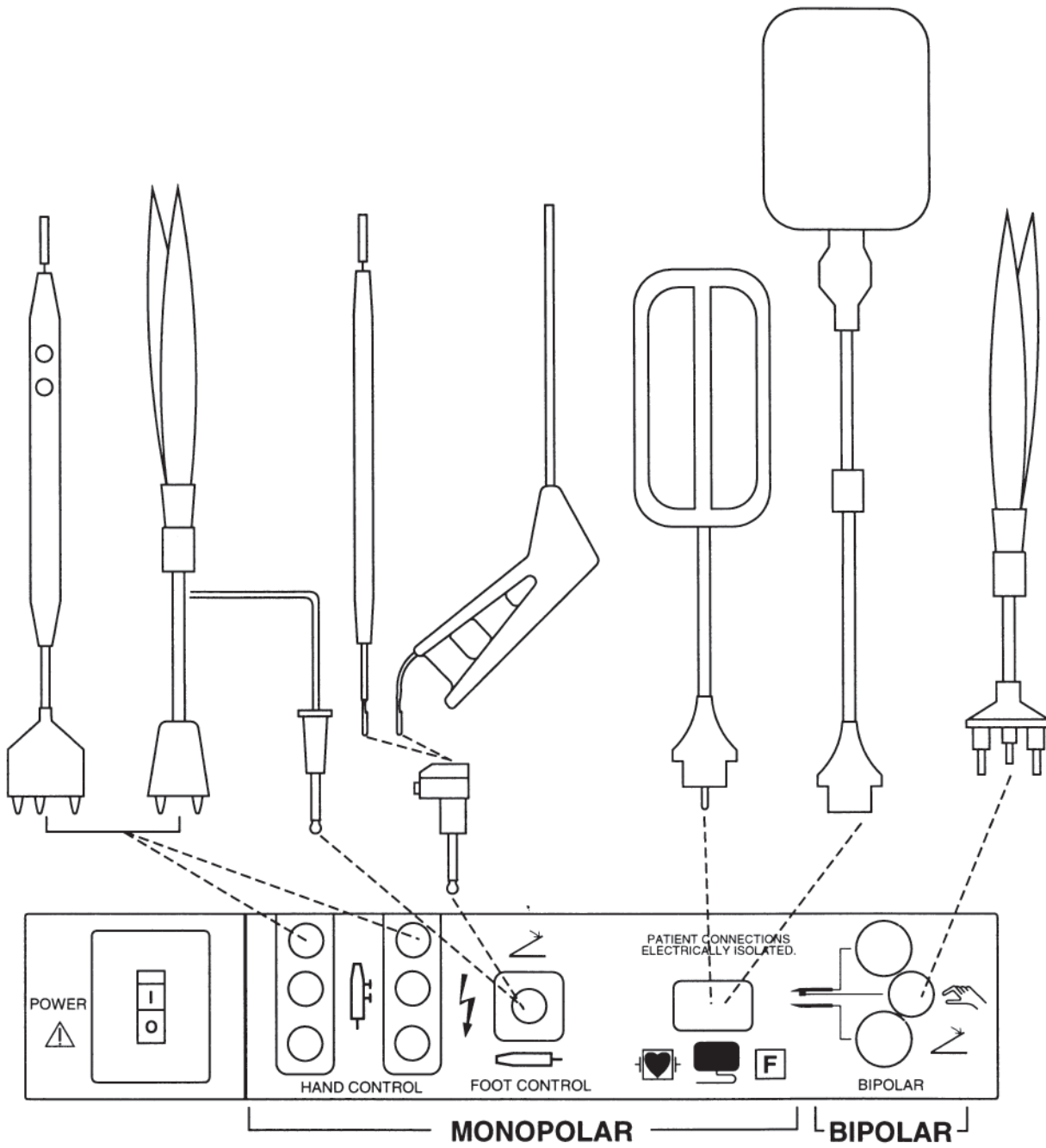
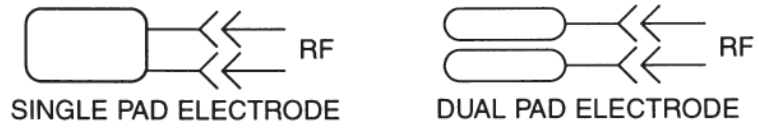
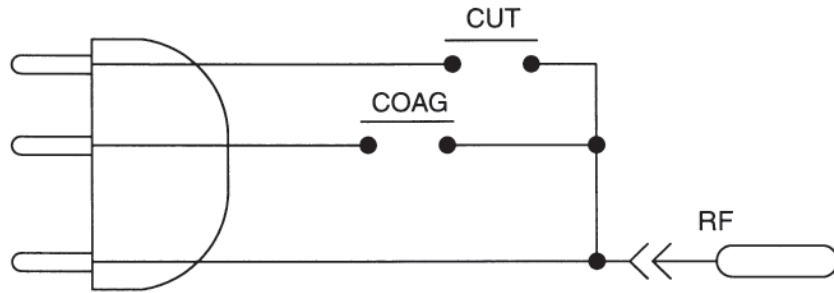


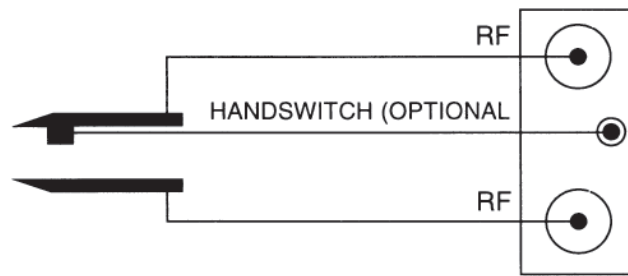
Figure 2.3 Accessory Schematics



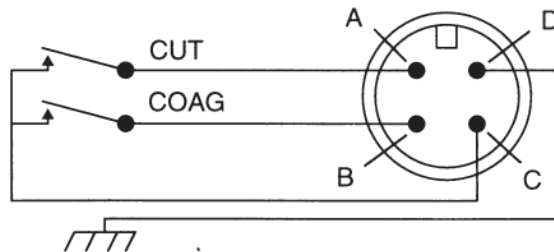
NEUTRAL ELECTRODE CONNECTIONS



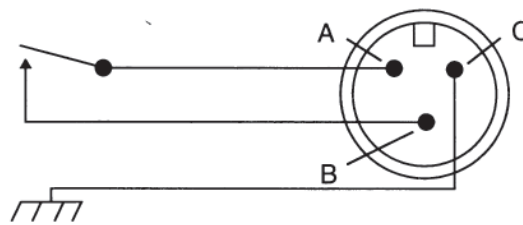
MONOPOLAR HANDSWITCHED ACTIVE CONNECTIONS



BIPOLAR ACTIVE CONNECTIONS



MONOPOLAR FOOTSWITCH CONNECTIONS



BIPOLAR FOOTSWITCH CONNECTIONS





This page intentionally left blank.



Theory of Operation

Section 3.0

This section contains the theory of operation for the Excalibur Plus PCTM circuitry. The functional block diagram and schematics are located in Section 4.0. These figures are folded such that they may be pulled out for viewing while reading the appropriate section.

3.1 Functional Block Diagram Description

The Functional Block Diagram appears in Schematic 4.0. This diagram illustrates the functional partitioning of the unit, without regard to physical location. Each block defines a major function (as noted inside the block) along with the reference designator(s) of the component(s) that serve primary roles in implementing the function. Each reference designator includes an assembly number (A1, A2, etc.) for cross-referencing to the Schematics in Section 4.

The relationships among each block are described by the signals that interconnect them. Narrow lines represent individual signals and are marked with the same signal mnemonics used in the schematics.

Broad lines denote busses, or groups of signals which together serve a common function. To avoid clutter, busses are not necessarily marked with signal mnemonics. Where a bus contains signals all bearing a common mnemonic form, the characters common to all of the mnemonics are shown, with XXs denoting characters which differ among the signal names. For example, the bus marked /FXX contains the signals named /FCT, /FCG and /FBP. These refer to the foot switch activation signals for Cut, Coag, and Bipolar respectively.

Arrowheads describe the direction of signal flow. Most signals are generated at a single source and have one or more destinations. An exception is the Data Bus on the A3 Controller PWB. This bus is bi-directional in that signals may travel either direction from any one of a number of

sources. However, only one source may be active at a given time. That source is determined by the Microprocessor which drives the proper signal states out on the Address and Control busses.

3.2 Power Supplies and Distribution

The Power Supply for the Excalibur Plus PCTM converts ac mains power into the various dc voltages required to operate the internal circuitry. This conversion takes place in three stages.

1. Mains power is ac-regulated and isolated by a ferroresonant power transformer.
2. Power from the transformer secondaries is then rectified and capacitively filtered to produce three separate sources of dc power (nominally +110 Vdc, +16 Vdc and +8 Vdc). The +110 Vdc source is used exclusively to power the RF Power Amplifier on the A4 Power Conversion PWB without further regulation.
3. The +16 and +8 Vdc sources are distributed throughout the unit where they are modified further by regulation or switching to supply the various loads in the unit.

MAINS DISTRIBUTION. Refer to the Interconnect Schematic, Figure 4.1. The mains power cord is terminated at a grounding lug and a nylon screw terminal block, A6TB1, for ease of field replacement. Harness A9W1 delivers power to the two-pole circuit breaker, A9CB1, mounted on the output panel. A9CB1 serves both as a lighted power switch and to protect the unit from overloads. On overload, this device automatically switches its handle to the OFF position.

Harness A9W1 returns switched mains power to A6TB1 for connection to the primary windings of power transformer A6T1. Strapping options on A6TB1 allow setting the unit for a given mains voltage range (120 V or 240 V) by connecting the primary windings in parallel or series,



respectively. See Section 4.2.5.1 for instructions on changing the factory supplied strap option.

POWER TRANSFORMER. Power transformer A6T1 is a ferroresonant type. Also known as constant voltage transformers, these devices provide regulation against variations in mains voltage. This feature is primarily responsible for the Excalibur Plus PC™'s ability to hold RF output power steady in the presence of mains voltage variations over the specified range.

Ferroresonant transformers have some unusual physical and electrical properties:

1. A special secondary winding (red leads 5 and 6 on A6T1) connects to an ac capacitor, A6C1. If this capacitor is open or shorted, the secondary voltage will fall well below normal.

>WARNING<

HIGH AC VOLTAGE IS PRESENT AT A6C1 WHEN THE UNIT IS OPERATING. USE CARE TO AVOID ACCIDENTAL CONTACT OR NICKING OF THE WIRE INSULATION WHEN WORKING IN THIS AREA.

2. The secondary voltage waveforms are square rather than sinusoidal in shape. Most ac voltmeters are calibrated only for sine waves, so the secondary voltage readings on A6T1 may vary widely between different instruments. The rectified dc output voltage is the most repeatable indication of secondary ac voltage.

3. A secondary overload of greater than 200% will cause the transformer to go into current limit with very low secondary voltage and less than full load mains current. Before diagnosing a defective transformer, first eliminate the possibility of a secondary fault, such as a shorted rectifier or filter capacitor. The low power secondary (leads 9 and 11) is provided with internal thermal fuses, since it is possible to overload the winding so that the insulation rating would be exceeded without going into current limit.

4. The magnetic core saturates briefly every half-cycle. This high flux density produces higher than normal core losses, so the core runs fairly hot to the touch even at idle. The device is

mounted using rubber grommets because high core flux produces more audible hum than ordinary transformers. When the core saturates, a burst of magnetic flux can induce mains-frequency noise into nearby wiring. For this reason, do not alter the harness dress near A9T1.

5. Conventional ferroresonant transformers, used in all Excalibur Plus PC™'s specified for 50 or 60 Hz only, are sensitive to mains frequency variations. Units specified for use as 50-60 Hz employ a special Controlled Ferroresonant Transformer which electronically regulates dc output voltage. The latter are equipped with a Control Module, which samples +16 VAC via A4P4, and an Overvoltage Protection module, which will drive the transformer to a minimum output condition if +16 VAC or +110 VAC at A6BR1 or BR2 exceed preset voltage limits. Both modules are contained in a potted housing mounted atop the power transformer.

CAUTION: Never operate the unit at a nominal mains frequency other than that specified on the Nameplate and A9T1.

RECTIFICATION. The secondaries of A9T1 are terminated in terminal block, A6TB1 (the terminal numbering on this block matches the lead numbering on A9T1). Harness A6W2 connects to the bridge rectifiers A6BR1 and A6BR2 and carries the rectified power to the A4 Power Conversion PWB via A4J3.

A6BR2 acts as a conventional full-wave bridge rectifier for supplying +16 V, while simultaneously acting as a negative-leg full-wave center-tap rectifier in providing +8 Vdc.

A4 POWER PROCESSING AND USAGE. Refer to the A4 Power Conversion PWB Schematic 4.5. Capacitors C11 and C20 filter the +110 Vdc supply delivered at A4J3, while R12 acts as both a minimum load and a bleeder to discharge the capacitors when power is turned off. The negative leg of A6BR1 is connected to ground via a 0.1 ohm current sense resistor, A4R8. The signal -ISENSE is a negative dc signal used on the A3 Controller PWB to monitor the supply current drawn by the Power Amplifier.



Capacitors A4C8 and C9 filter the +16 and +8 Vdc sources. The +16 Vdc source supplies A4VR1, which provides regulated +12 Vdc and +12 GND to the Power Amplifier gate driver ICs, A4U1 and U2. Both +16 and +8 Vdc then feed the rest of the low-voltage dc loads via connector A4J1.

Harness A9W6 carries +16 and +8 Vdc to the A2 Display and A3 Controller PWBs mounted inside the shield on the top cover, A8.

3.3 Controller Hardware

The Excalibur Plus PC™ Controller PWB Assembly is based on the 8031, a single chip, 8-bit microprocessor which utilizes external program memory. Refer to Schematic 4.4a. This controller has the following features:

1. Four 8-bit Ports (0,1,2,3) which are individually addressable as 32 Input/Output (I/O) lines.
2. Two 16-bit timer/event counters, one of which is used as a software controlled tone generator via the serial transmit pin TXD (U3 Pin 11).
3. 64 K bytes of externally addressable program memory (A3U1).
4. On-chip oscillator and clock circuit which is connected to an external 10 MHz clock signal derived from a 20 MHz quartz time base (A3Y1).
5. 128 bytes of internal RAM used as a "scratch pad" by the processor.
6. Battery backed static RAM. This is used both for "scratch pad" RAM, and for storage of calibration values and user stored "Program" settings. Minimum battery life is 10 years.

The remainder of the controller circuitry consists of the Watchdog Timer (WDT), Power On Reset (POR), Address Decoder, Peripheral Interface Adapter (PIA), Base Voltage Generator (BVG), Current Sensing Circuit, Waveform Generator (WFG), Tone Generator, and the Aspen Return Monitor (A.R.M.) DAC and current source.

3.3.1 Watchdog Timer (WDT)

The function of this circuit is to monitor the microprocessor for a failure that would cause unpredictable results. During normal operation, the microprocessor program executes in a known sequence. If a software error is detected, an internal interrupt is generated which halts the operation of the microprocessor. If there is a hardware failure sensed by software control, program execution will again be terminated.

Should a failure occur in the CPU that prevents the detection of a problem, thus allowing program execution in a random manner, the Excalibur Plus PC™ is designed so that the WDT detects the problem. The WDT shuts down the malfunctioning unit to minimize the effects of the failure. This is accomplished by requiring the microprocessor to write to the WDT once during each program execution cycle. This WRITE PULSE is referred to as the Watchdog Timer Strobe (WDTSTB). The WDT circuit must hear from the microprocessor within a hardware set window. If the WDTSTB occurs early because the program "skipped" a portion of the software or late because it was "hung" in a program loop, the following results:

1. The circuit latches in the failed condition so that further strobing from the microprocessor cannot clear the previous failure.
2. An interrupt (/WDTINT) is generated which stops abnormal program execution. If the microprocessor can still respond to the interrupt, a "fatal" software routine will execute, displaying an error code "Err 4.2".
3. The interrupt signal /WDTINT, is used to generate /WDTFL, which disables the Base Voltage Generator and Waveform Generator, preventing further generation of RF output.

The Watchdog Timer (WDT) is made up of a dual, retriggerable, one-shot multivibrator (U7), associated RC timing components (R4, C5, R6, and C6), the relay power enable register (U10), and associated gates (U5 and U6). A WDTSTB is generated whenever U10-2 and U10-3 are both low. The first stage one-shot is set to time out at the minimum WDTSTB interval by the RC combination of R4 and C5. With C5 = 1 μ f, the time



is equal to $R4(K \text{ ohms})$ in milliseconds. Example: if $R4=10K$, the time is 10 milliseconds. The trailing (falling) edge of WDTSTB triggers the first stage causing Q1 (U7-6) to go true (high) for the time interval. The rising edge of Q1 triggers the second stage one-shot via U7-12, causing Q2 (U7-10) to go high and /Q2 (U7-9) to go low. The timing of this stage is set by the RC combination of R6 and C6. In normal operation WDT strobes will occur after stage 1 has timed out ($Q1=0$) but before stage 2 times out ($Q2=1$). The one-shot is retriggerable and the rising edge of Q1 will restart the timing sequence in the second stage even though it may not have completed its current time delay. Normal operation is indicated by /WDTINT (Q2) never going low.

The relay enable flag, RLYEN-Q from U10-10, is reset on power-up. This permits the microprocessor (U3) to test the WDT during initialization without allowing RF to appear at the outputs. While RLYEN-Q is disabled (low), the WDT will not lock up, permitting the software to test for correct operation. This is done by strobing the WDT early, late and looking for the generation of the interrupt /WDTINT ($Q2=0$). The WDT is then triggered within the correct time window and should result in /WDTINT remaining high. If these results are obtained, the WDT timer circuitry is operating normally.

After initialization is complete, the microprocessor generates a WDTSTB at the start of the first normal program timing cycle. The relay enable flag, RLYEN-Q, is set by the NOR gate, U10-5 and U10-6 both going low. After this, the program enters the normal operation program loop.

If a WDTSTB is not generated within the period of the previous strobe, the second stage will time out and Q2 will go low resulting in a /WDTINT. Since RLYEN-Q and /Q2 (U7-9) are high, the inputs to U6-4 and U6-5 are both true resulting in its output (U6-6) going low. This resets the first stage one-shot. Now that Q1 (U7-6) cannot go high, Q2 (U7-12) is prevented from being retriggered. With the WDT Q2 output gone low, the microprocessor will execute a WDT failure interrupt routine in response to /WDTINT falling, and /WDTFL will disable drive to the power amplifier.

If the WDTSTB is generated early, while Q1 is high, the NAND gate (U6-1 and U6-2) will both be high resulting in U6-3 going low and resetting the second stage. This causes the same results as the late strobe described above.

Note that the signal which causes the WDT to latch and ignore all subsequent WDTSTB pulses is RLYEN-Q being high. The only way to reset RLYEN-Q is a Power On Reset.

3.3.2 Power On Reset

The Power On Reset (POR) circuit consists of a single chip specifically designed for this function, A3U4, and associated components R1 and U5. The POR circuit monitors +5 Vdc (U4-8) and the output signals RST (pin 5) and /RST (pin 6) become active if +5 Vdc falls below 4.75 Vdc. The 8031 microprocessor operation is specified down to 4.5 Vdc. This allows power supply margin for proper power down of the controller until reset occurs. When /RST is low, the microprocessor is reset via the Inverter U5-12. This prevents inadvertent writes to the NOVDRAM during power transitions, when the control and address/data busses are in unknown conditions. On power up, RST and /RST are kept active for a minimum of 250 msec to allow the power supply and microprocessor to stabilize.

The power monitor (U4), also provides an input (pin 1) for direct connection to a switch (A3S1-4). Anytime /PB is low for over 10 msec, the outputs RST and /RST become active. They remain active for a minimum of 250 msec after the switch is moved from the "/RST" position.

One last feature of this circuit is its function as a secondary watchdog timer. This is enabled by the connection of Address Latch Enable (ALE) from the microprocessor (U3-30) to U4-7. The RST and /RST outputs are forced to an active state when the /ST input (U4-7) is not stimulated for 1.2 seconds. This function is not normally used because it requires a failure in the microprocessor and the Watchdog Timer circuitry. This is considered a double fault condition and the odds of the two occurring simultaneously are very low. Also, it is possible for ALE to continue in normal operation while other parts of the microprocessor are not. The WDT circuit described previously, is



used because it is not susceptible to this failure in fault detection.

3.3.3 Controller, I/O

The four digital ports of the 8031 (U3) are functionally assigned as follows.

PORT 0 (P0.0 - P0.7). This port serves two digital functions: 8-bit data bus for communicating with external I/O, and low-order address bus for accessing external Program Memory.

PORT 1 (P1.0 - P1.7). This port is dedicated to discrete inputs or outputs. Port 1.2 generates the signal /RFEN used to control RF output. Port 1.3 is /LOUD which bypasses the audio volume control during alarm conditions. Port 1.4 reads the signal ARMCOMP which is supplied from the comparator U23-13. ARMCOMP is used during a software controlled successive approximation routine to determine contact resistance of the Return Electrode. See Section 3.8. Port 1.6 is used to control the upper and lower 512 byte Memory Bank of U2. Port 1.7 is the Interrupt Request (IRQ) from the keyboard/display controller (A2U2) which resides on the Display PWB. It is generated whenever a keyboard button is depressed. IRQ does not actually interrupt the microprocessor, but is simply read in as another I/O line.

PORT 2 (P2.0 - P2.7). This port supplies the high-order address bus which reads from external Program Memory and writes to external I/O. All I/O is memory mapped so that distinct addresses access specific devices. The system is configured so that only one device is addressed at a time.

PORT 3 (P3.0 - P3.7). This port generates special signals used to control the overall system. These are /RD, /WR for reading or writing to external I/O, /PSEN (Program Store Enable) which enables the external Program Memory to the bus during instruction fetches, and ALE (Address Latch Enable) used for latching the low-order byte of address during access to external Program Memory. Port 3.1 generates the signal, /TONE, which is the source of the various audio tones used to signal activation or alarm conditions. Port 3.2 is the input for external interrupt, /WDTINT, from the Watchdog Timer. Port 3.3 is the input for the external interrupt, /IFAIL,

generated by the current monitor. Ports 3.4 and 3.5 control the 128 byte Pages of the memory at U2.

The Address Decoder (U9), is used to select external I/O devices for reading and writing. High-order address to the decoder inputs, (A10, A11, and A12) cause the corresponding output (Y0 - Y7) to go low. After the address decode has stabilized, either /RD or /WR will go low to execute a data transfer with the addressed device.

Peripheral Interface Adapter (PIA), U11, is a general purpose I/O device designed to expand the number of addressable I/O lines available. It has three additional 8-bit ports (PA - PC) or 24 individually programmable pins. Port A is configured to read switch closures from hand and foot controls; Port B supplies an address to the Waveform Generator used to select specific output waveforms depending on the mode and power selections. Port C is used to activate the required relays to direct RF output to the appropriate accessory, and to control the Waveform Generator latch.

3.3.4 Memory

The program used by the microprocessor is stored in external memory, the byte-wide EPROM (U1). It is programmed and verified at the factory to ensure correct operation of the ESU. The following is the Memory Map for the 32Kx8 EPROM.

<u>Address</u>	<u>Code</u>	<u>Block</u>
0000-0FFFH	CAL ONLY	4K even
1000-1FFFH	CAL and RUN	4K odd
2000-2FFFH	CAL ONLY	4K even
3000-3FFFH	CAL and RUN	4K odd
4000-4FFFH	CAL ONLY	4K even
5000-5FFFH	CAL and RUN	4K odd
6000-6FFFH	CAL ONLY	4K even
7000-7FFFH	CAL and RUN	4K odd

When the switch at A3S1 is in the CAL position, Address Line A12 is low, and enables access to the entire EPROM through the OR gate (U8-3). Mutually exclusive calibration code is located in the even 4K blocks. When the switch at A3S1 is in the RUN position, Address Line A12 is high, and disables access to half the EPROM through the OR gate (U8-3). Run mode code (or shared



code used in calibration) is located in the odd 4K blocks. The gate function at U8 thus ensures that calibration code cannot be accessed when in the run mode.

The address latch at U24 captures the low order address byte (A0 - A7) when control line ALE is active. The data is then enabled on to the same bus when /PSEN and ALE are both low (0,0). In this manner the address/data bus (AD0 - AD7), alternates between carrying the low order address for the next instruction from the microprocessor and reading the data, which is the code for the next program step, back to the microprocessor. The high order address bus (A8 - A14), is used for addresses only and does not require latching since the information is available during the entire memory read operation. The only time /PSEN is active is during a program instruction fetch. When the microprocessor is addressing external I/O, such as the PIA or NOVRAM, the signal/PSEN remains high. AD0-AD7 is an I/O bus whenever /PSEN is high.

The Nonvolatile Random Access Memory (NOVRAM), U2, is a battery backed static RAM. This device stores the calibration coefficients, power settings and user programs used by the microprocessor to control accurate power output levels and to measure return electrode resistance.

When the ESU is powered up, the data stored is accessed by the microprocessor via the address/data bus.

3.3.5 Base Voltage Generator

The base voltage generator is schematically depicted on the A3 Controller Board Schematic 4.4b. It is microprocessor controlled with two analog feedback paths that can turn the base voltage down in case of excessive power amplifier current and high output voltage. The high voltage shutback is not active in monopolar coag modes.

The base voltage generator is made up of an 8 bit DAC (U20), a differential amplifier (1/4 of U21), an inverting breakpoint summing amplifier (1/4 of U21), and power transistor A8Q1. U20 provides the input voltage selected by the microprocessor by the address lines AD0-AD7. R25 is a passive pulldown required by the DAC to reach the lower DAC output voltages. Since resistor

R32 includes the power transistor A8Q1 in the opamp feedback loop, the combination of Q1 and U21 (pins 1, 2, and 3) may be considered as a power opamp for analysis purposes.

The -ISENSE and IGND signals are developed in the RF power amplifier on the Power Conversion Board A4. These signals are generated by the power amplifier supply current passing through sense resistor A4R8. The resulting voltage -ISENSE is proportional to the total dc current used by the RF power amplifier. The portion of U21 that includes pins 5,6, and 7 makes up a low pass filtered differential voltage amplifier that amplifies the -ISENSE voltage by 10. The resulting ISENSE voltage is proportional to the dc current drawn by the Excalibur Plus PC[™] RF power amplifier from the +110V supply. When ISENSE exceeds the voltage at U21-3 by a diode voltage drop, the ISENSE feedback loop becomes dominant and backs VBASE down to maintain the RF power amplifier current at its limit. This is independent of microprocessor control and is an additional safety feature.

When the Excalibur Plus PC[™] is in a monopolar coag mode, either WV6, WV7, or both will be high, thus forcing pin U8-6 high, which in turn makes U12-12 go low. This action prevents the VSENSE voltage from turning back VBASE to limit RF output voltage. In all other modes, U12-12 floats and allows VSENSE to be active. When VSENSE exceeds the voltage at U21-3 by a diode voltage drop, the VSENSE feedback loop becomes dominant and turns VBASE down to limit the amount of RF output voltage. This action occurs primarily at high power settings of monopolar cut and blend modes at high load impedances to prevent excessive arcing at the active electrode.

The foregoing action takes place only in Spray Coag. In Standard Coag, VSENSE feedback gain is present but highly attenuated by R43 in order to limit RF leakage.

The inverting breakpoint amplifier (pins 1, 2, and 3 of U21) gain varies with the VDAC input voltage. Refer to Fig. 3.1. When VDAC is in the high range (producing a low VBASE since the amplifier inverts), the incremental gain is -R32/R26. This low gain provides a finer control of VBASE at the low power settings. At lower VDAC voltages, diode D5 becomes forward



biased so that R9 is essentially in parallel with R26. Then the incremental gain is $-(R32/R26 + R32/R9)$. This steeper gain allows VBASE to reach the voltage levels necessary for the higher power settings. The voltage where the gain slope changes is determined by the Thevenin equivalent of +12V, R11, R10 (shown as Vth and Rth in Fig 3.2) and R9. R23 is summed into the break-point amplifier to subtract out the effects of the 5V on the non-inverting pin of the amplifier, thus allowing the output of the base voltage generator to go to zero.

R34 and R35 form a voltage divider to generate a 5V offset for U21-3 to allow single supply operation and to give a reference point for the VSENSE and ISENSE voltages. When RFEN is low, U23-2 forces that voltage divider low, which causes VBASE to turn off. When /WDTFL goes low, U23-1 forces the base of A8Q1 low which causes VBASE to turn off.

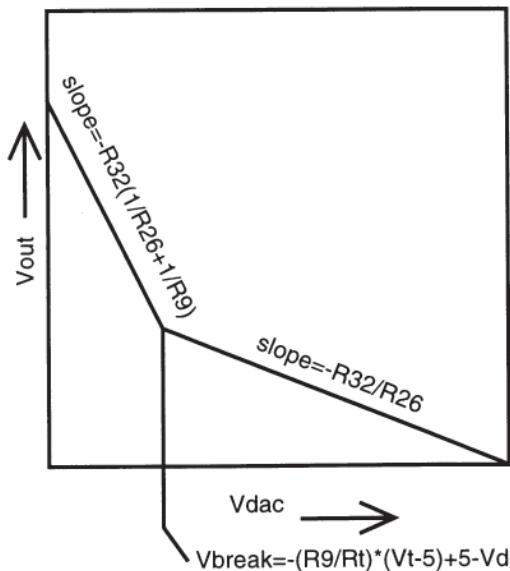


Figure 3.1 Base Voltage Generator Transfer Curve

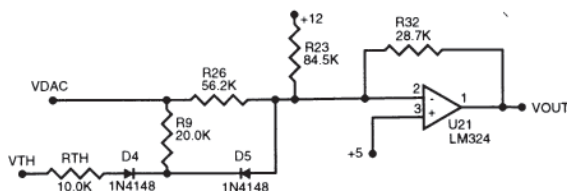


Figure 3.2 Basic Inverting Break Point Amplifier

3.3.6 IFAIL DAC

Schematic 4.4b contains the IFAIL DAC A3U19. The output of this 8 bit DAC (2.55 Vdc maximum output voltage) is fed into the reference input of U23-9. The DAC is controlled by the microprocessor to produce a reference voltage for each mode of operation and power setting. The ISENSE signal (refer to section 3.3.5 for a description of ISENSE) is voltage divided and lowpass filtered by R39, R49, and C61.

Whenever the resulting voltage exceeds the reference input voltage provided by the DAC U19, /IFAIL will go low and an interrupt is generated, warning the microprocessor that the RF power amplifier current is exceeding the maximum allowed for that particular output mode and power setting. This is a fatal alarm that produces a "Err 5.2" code and shuts down the Excalibur Plus PC™. Although it is possible for this to occur because of a temporary fault condition and may be recoverable by cycling power, it generally occurs because of a problem in the Excalibur Plus PC™ circuitry and should be checked by the Biomedical Department before returning the unit to service.

Note that the same DAC is used for the A.R.M. circuitry approximately every 12 milliseconds for about 200 microseconds. During that time, the microprocessor ignores /IFAIL since the reference voltage provided by the DAC is being used to provide a signal for the ARMCMP comparator. See section 3.8 for a more detailed explanation of the A.R.M. circuitry.

3.3.7 Waveform Generator

Schematic 4.4b contains A3U18, a 32Kx8 EPROM that stores the bit patterns for the waveforms that drive the RF power amplifier. The EPROM is arranged so that the upper address lines, WV0-WV7, determine which waveform is selected by the microprocessor, and the lower address lines, WA0-WA6, determine which byte of the waveform is selected at a time. The lower address counter (A3U15 and A3U16) cycles through its count to sequentially select each byte of the waveform and to reload its own count modulus at the beginning of each waveform. The selected byte of the waveform is then parallel-loaded into shift register A3U17, where it is seri-



ally-shifted out to the buffers U13A and U13B one bit every 50 nanoseconds.

A3U14 is configured as a modulus 8 counter that controls the parallel loading of the shift register A3U17 and increments the lower waveform address counter (A3U15 and A3U16). Both the loading and incrementing occur on the rising edge of the 20 MHz clock when /SRLOAD (U14-11) goes low and then high. A3U14 also generates 2.5 MHz and 10 MHz clocks from the 20 MHz oscillator Y1 for clocking the Display/Keyboard Driver/Encoder A2U2 and the microprocessor A3U3.

Each time /SRLOAD goes low and then high, the lower waveform address counter formed by A3U15 and A3U16 advances its count. The outputs from this counter (A0-A7) select the next 8 bit word to be loaded into A3U17 from A3U18. When the lower waveform address counter reaches its full count, i.e., the entire waveform has been completely output, /CNTRLD goes low on the next count and the address counter is preloaded to the pattern presented to it by O0-O7 of A3U18. This pattern sets the modulus of the address counter and thus the length of the waveform bit pattern. /CTRLOAD also clears the shift register A3U17 to zeros to prevent putting the modulus pattern out to the power amplifier. Since /CTRLOAD is low only at the beginning of a waveform, it is an excellent point to use for a scope trigger when examining waveforms (use TP20).

U13 provides both buffer and enable functions for the waveform generator. U6D and U8C control the latch of the waveform.

3.3.8 Tone Generator

Schematic 4.4b contains the Tone Generator. It is a voltage controlled current source that is switched on and off at the frequency of the desired tone. /TONE is generated by the microprocessor A3U3 at the desired audio frequency and is buffered by sections of A3U5 and A3U12 to generate the signal SPKR-. When SPKR- is inactive, no current flows through speaker A8SP1, thus there is no sound. When SPKR- is low, the current flow through the speaker is determined by R16 and the base voltage of A3Q2.

A9R1 (the volume control pot) and A3R18 form a voltage divider to set the base voltage of A3Q2. The emitter voltage of A3Q2 is one diode drop higher than its base voltage and is a constant for a given base voltage. This controlled emitter voltage across R15 means a current is flowing through A3Q2 that can be controlled by the base voltage. That is how the volume is set for normal operation. When an alarm is sounded, /LOUD from the microprocessor (which is buffered by sections of U5 and U12) forces the base voltage of A3Q2 into saturation regardless of the setting of the volume control pot. This is to assure that an alarm cannot be turned down in volume.

3.3.9 Base Voltage Monitor

R55, R60, R61, R62, D8, C72, and U26:A form a +5 Volt Overvoltage shutdown circuit. When the +5 Vdc supply rises above 5.4 Vdc, U26-2 forces the base of A8Q1 low which causes VBASE to turn off.

R63, R64, R71, C69 and U26:B form a Base Voltage Check circuit. The DAC at U19 is controlled by the microprocessor (with interrupts disabled to ignore /IFAIL) to produce a VBase reference voltage for power up self tests and at least once every 500 mSec for each mode of operation and power setting when power is on during normal operation. When RF is activated and the resulting voltage exceeds the reference input voltage provided by the DAC U19, VBASHI will go high. This input is then read by the microprocessor, and if high, causes a fatal error that produces an "Err 22.2" code and shuts down the Excalibur Plus PC. Power On Self Test Errors are "Err 22.0" if the VBase voltage is too low and "Err 22.1" if the VBase voltage is too high. Although it is possible for these errors to occur because of a temporary fault condition and may be recoverable by cycling power, it generally occurs because of a problem in the Excalibur Plus PC circuitry and should be checked by the Biomedical Department before returning the unit to service.

3.3.10 Waveform Monitor

R67, C70 and U26:C form an Average Waveform Check circuit while R65, R66, C74 and U27 form a Duty Cycle to Voltage circuit. The DAC at U19 is controlled by the microprocessor (with inter-



rupts disabled to ignore /IFAIL) to produce a Waveform reference voltage for power up self tests and at least once every 500 mSec for each mode of operation and power setting when power is on during normal operation. When RF is activated and the resulting voltage is outside the reference input voltage provided by the DAC U19, AWFMI will go high if the Waveform voltage is too high or low if the Waveform voltage is too low. Input is then read by the microprocessor and if the test fails, fatal errors that produce an "Err 23.2" code occurs and shuts down the Excalibur Plus PC. Power On Self Test Errors are "Err 23.0" if the Waveform voltage is too low and "Err 23.1" if the Waveform voltage is too high. Although it is possible for these errors to occur because of a temporary fault condition and may be recoverable by cycling power, it generally occurs because of a problem in the Excalibur Plus PC circuitry and should be checked by the Biomedical Department before returning the unit to service.

3.3.11 Tone Monitor

A Tone Detector Shutdown circuit is provided to shut down the RF output in the absence of the audio tone, independent of the software function. D11 and C73 half wave rectify the 16 Vdc tone oscillator which is AC coupled through C71, while D12 discharges C71 during the negative half cycle. R68 and R69 divides the 16 Vdc to a maximum of 11.76 Vdc to remain below the maximum 12 Vdc input voltage to U26:11. R22, R70 and U26:D form the comparator which will enable/disable the gate outputs through U13:A and B.

3.4 Controller Software

The behavior of the Controller is a function of the custom program residing in the EPROM memory (A3U1). Since U1 contains a custom program, it must only be replaced with a suitably programmed part. Most failures of this part may be traced to mishandling, particularly due to static discharge or to a secondary failure resulting from application of excessive voltage to the circuit, as may occur if a voltage regulator fails. However, since undetected failure of the EPROM could escalate a minor failure to a serious consequence in the O.R. environment, the program is

equipped with many fail detection and shutdown features. Further, an independent external circuit (the Watchdog Timer) guards against a malfunctioning EPROM or CPU operation. This safety system is discussed in the following overview of the program.

3.4.1. Software Initialization and Test Functions

The following list of software functions begins at Power On Reset or by a manual reset performed by an internal CAL/RST/RUN switch. The following initialization sequence must be successfully executed before the main working program can be entered.

1. Initialize outputs to relays and indicators.
2. Initialize all data memory locations for the working program.
3. Verify that the Watchdog Timer is functioning correctly and that it can control RF shutdown.
4. Verify that the RF current circuitry is operating.
5. Verify that no shorts exist in the hand/foot controls.
6. Verify that no shorts exist in the membrane panel.
7. Verify that internal data memory input/output lines function properly and without crosstalk using a walking bit test.
8. Verify that the contents of program memory in all locations where the program resides is intact using a 16 bit CRC (Cyclic Redundancy Check).
9. Verify that the contents of the calibration memory (NOVRAM) in all locations where data resides is intact using a 16 bit CRC (Cyclic Redundancy Check).
10. Perform Display and Tone tests.
11. Enable RF output relays and pass control to the working program.



Failure of any of the above self-tests will result in the end of program executions, and a display of "Err" or "ACC" on the Cut display. A Machine Fault tone is sounded to alert the operator and a fault code is displayed on the Coag Power Level LEDs. See Appendix A for a list of the codes and possible causes.

3.4.2. Working Program Functions

The main program loop is executed continuously by calling the working subroutines and refreshing the Watchdog Timer circuit on each pass through the loop.

Bipolar, hand control, foot switch, and return electrode inputs are monitored for changes. The validity of the input conditions are checked. The following conditions are considered illegal requests and result in a operator error tone:

- Simultaneous monopolar and bipolar requests.
- Simultaneous Coag and Cut requests.
- More than two simultaneous requests.
- Any activation request other than bipolar with the Return Fault indicator ON.
- Attempt to store a setup at the "0" or "P" program locations.
- Any request for power change while activated, except for the activated mode.
- Any request for power change in Remote Power Control except controlling handpiece.

In the case of an illegal hand/foot request, the last valid request is the one honored. Other operator actions that can result in a pulsing operator error tone are multiple or stuck key press, or attempting to increase or decrease power levels beyond the machine limits.

The current condition of the hand/foot controls and the keyboard are continuously monitored. When a valid request to change mode or power level is received, the displays are updated to reflect the change. When a valid request for RF activity is received, the following sequence is performed:

1. The appropriate RF indicator lamp and tone are activated.
2. The requested accessory output relay is closed.

3. The current limit fail-safe is set.

4. The power setting is used to retrieve waveform and amplitude parameters from the calibration memory which are then sent to the RF drive circuits.

5. RF output is enabled via /RFEN.

Self-tests are continuously performed during operation to ensure the integrity and reasonableness of hardware and software operation during the working program execution. Failure of these tests will result in a safe end-to-program execution (RF drive and all relays are disabled). A display of "Err" on the Cut power levels LEDs and a loud alarm tone alerts the operator to the condition. The appropriate error code is displayed on the Coag Power level LEDs to indicate the errors.

3.4.3 CAL Mode Software

The CAL mode is used to calibrate the unit. It also provides access to Watchdog Timer and Pseudo Run Mode diagnostics, which are provided to simplify troubleshooting of faults which would otherwise leave the unit inoperative due to fault detection shutdown in RUN mode. A final function is the ability to view the Last Fault Code (LFC) that occurred in RUN mode, and to clear the LFC.

When CAL mode is first entered, a display check occurs for 30 seconds or until any key is pressed. At that point an abbreviated self diagnostics occurs, and if successful, CAL mode is entered.

3.4.3.1 Calibration

Calibration mode allows the technician to modify the calibration tables to correct for drift over time, or to correct for new components after a repair. During Power Calibration, each calibration table value can be adjusted up or down when the unit is activated. The adjustment range for each entry is limited to $\pm 25\%$ around a nominal setting. The adjusted calibration value is stored in nonvolatile memory, additionally, both the base voltage drive (VBASE) and gate drive waveform (/GATE) are sampled and stored to act as references for checking over power conditions.

NOTE: Since VBASE is in the output voltage



limiting circuit feedback loop, it is important that calibration is only done with the proper load attached. This will ensure that the unit is not in a voltage limited mode and store the wrong VBASE value. During ARM calibration, the unit stores a value that corresponds to the resistance attached at the return pad connector. There are software limits to confirm that the resistor or circuit are within reasonable limits.

For each mode, the software checks to see if any points have been changed. If at least one has, it will require that all points that have not yet been selected be activated. Points that have not been checked are denoted by flashing the display when those points are selected. An Err code 10.X will occur if the power calibration menu is exited with an incomplete calibration. Additionally, the unit will check that all calibration points are monotonic when the menu is exited, that is, it will verify that successively higher power entries in each mode are equal or contain successively higher drive values. If not, an Err code 11.X will occur. If both checks pass, the unit will calculate and store a new CRC to allow verification that the calibration has not changed and is stored properly.

During RUN Mode, the software interpolates the drive value for the present power setting between the calibration points. The drive value is then passed to the VBASE Generator or Waveform Generator necessary to produce the set power.

3.4.3.2 Diagnostics

Sections 4.7.1 - 4.7.3 contain the details for the use and operation of the diagnostic modes available from the CAL menu.

3.4.3.3 Last Fault Code

The microprocessor will store the last fault code that caused it to shut down in Run or Pseudo Run mode. From the top level Cal menu, LFC can be selected for viewing, and to clear the present code. See Section 4.7.1 for additional details.

3.5 Display Hardware

The Display PWB Assembly (A2), in conjunction with the Membrane Switch Panel (A1), is the user interface to the unit for all inputs except

hand or foot controlled activation requests. Power settings, mode requests, and return electrode alarm set point are all entered via the front panel membrane switches. The various indicators and displays supply machine operating status. These include requested power, mode, program, return electrode resistance, and alarms if they occur.

3.5.1 Indicators

Refer to the Display Schematic 4.3. The control of the indicator lights on the Display PWB is handled by the Peripheral Interface Adapter (PIA), U3. Address, data, and control signals are supplied to the PIA from connector J1. This device contains three registers (one for each Port), which can be individually written to or read from by the microprocessor. The three I/O ports are allocated as follows.

PORT A (PA0 - PA7). This port is connected to the octal DRIVER, U5, which controls the number of Bar LEDs that are illuminated in I22, the "ASSIST Resistance indicator" display. By writing a one to any of the eight inputs to U5, the corresponding output goes low, turning on the LED. Note that the first two LEDs of I22 and the last two LEDs are connected in parallel to the output of U5. This is done to interface the ten bar LED readout to the single byte output of Port A.

PORT B (PB0 - PB7) and Port C (PC0 - PC7). These ports control the various modes, activation, and alarm indicators. Whenever there is a one (high) written to a Port line, the output of the corresponding driver will pull to ground turning on the LED or lamp.

3.5.2 Displays and Keyboard

The control of the 7-segment displays and the keyboard is performed by the Keyboard/Display Interface, U2. Scanning of the keyboard and multiplexing of the displays is implemented by the outputs SL0 - SL2 counting in a binary fashion which is decoded by U4. The outputs of the DECODER and Driver (U4), go low sequentially (0, 1, 2, etc.) scanning I1 - I8 displays and both rows of the keyboard. Transistors Q4 - Q6, which connect the scan lines to the keyboard



rows, prevent the cross connection of the multiplexed signal whenever one of the keys is depressed. If one of these transistors shorts out, one of the 7-segment digits (I1 - I3) is written to continuously causing it to be overdriven and glow brighter than normal. Display I9 is lit through driver U7 when U2 SL3 is high and U4 is disabled by Q. The internal circuitry of U2 reads each digit data stored in internal RAM and drives the segment output (B0 - B3 and A0 - A3) in sync with the scan lines. Current is then supplied to the correct digit, displaying the appropriate number. The segment outputs of U2 are connected to the current driver (U1) which delivers approximately 40 mA to each segment. The displays are common cathode variety so that the current is supplied to the anode and pulled to ground at the common cathode connection by the scanned open collector driver.

The keyboard (Schematic 4.2) is part of the front panel assembly and is connected to the Display PWB through connector A2J3. There are also ground connections from the front panel electrostatic shield which is incorporated into the membrane switches. These grounds straps are connected directly to the chassis and prevent EMI (ElectroMagnetic Interference) and ESD (ElectroStatic Discharge) from being conducted into the logic circuitry via the keyboard.

3.6 Power Amplifier

The Power Amplifier (PA) is a hybrid cascode amplifier made up of high voltage bipolar transistors and low voltage power MOSFETs. See Schematic 4.5. Figure 3.3 shows the basic hybrid cascode amplifier configuration. The combination of Q1 and Q2 make up a fast, high-voltage amplifier that can be controlled by the combination of the dc voltage VBASE, and the fixed amplitude, variable pulse width signal, VGATE. In the OFF condition, VGATE is near ground, turning off Q2 so that no drain current can flow. Thus no base or emitter current can flow in the bipolar transistor. Since V+ is always greater than VBASE, the collector base junction is reverse-biased, so no collector current will flow and no power is delivered to the load. Turn-on commences with VGATE rising rapidly to about +10V. This results in a large pulse of base current flowing in Q1 from Cb, quickly turning Q1 on

which delivers power to Z1. After the turn-on transient, Q2 will be conducting hard and Q1 will draw collector current in proportion to its base current, which in turn is controlled by VBASE and Rb. At sufficiently high base current, Q1 saturates (collector-base voltage nearly zero), transferring maximum available power to Z1 while Q1 and Q2 dissipate little power due to the low voltage across them. Turn-off commences with VGATE quickly dropping to nearly 0 V, shutting off Q2 and effectively disconnecting Q1's emitter from the circuit. Collector current then flows out of Q1's base pin into Cb until all of the charge stored in Q1 during turn-on is washed out. Then Q1 completely shuts off, ceasing power transfer to Z1.

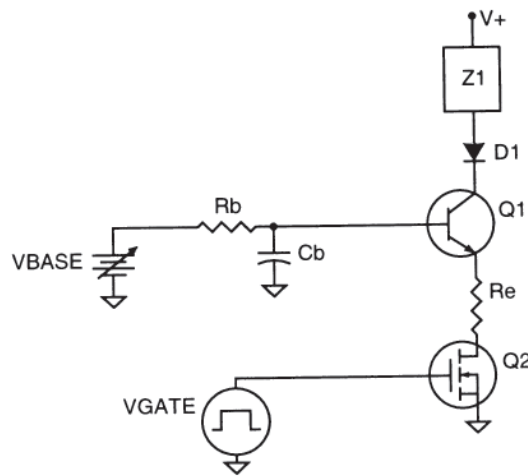


Figure 3.3 Basic Hybrid Cascode Configuration

The collector voltage may rise to many times the value of V+ after turn off. Since the emitter is now disconnected, the collector-base voltage can take on the highest value which that junction will sustain with little chance of second breakdown. The base bypass capacitor, Cb, is sized to ensure that it can absorb all of the stored turn-off charge without allowing Q2's drain voltage to approach its breakdown limit. Further, this charge is now available to charge the base on the next cycle, thereby significantly reducing the net current drain from the VBASE supply.

The saturated operation described above takes place in both Monopolar Coag and during high-power (>150 W) Cut. During the latter mode, power increases take place because the dynamics



of Z1 allow Q1 to saturate over a greater proportion of the conduction cycle as VBASE is increased. Once saturation occurs, excess stored charge accumulates, extending the time required to remove the charge on turn-off and effectively increasing the duty cycle of the amplifier. At lower Cut power settings, VBASE is too low to allow saturation, so Q1 conducts only partially, absorbing some of the power that could otherwise be supplied to Z1. This mode is not as efficient as saturated operation because Q1 sees simultaneous voltage and current. However, the current at this point is low enough to limit Q1's dissipation to that which can be dissipated by the heat sink without excessive junction temperature rise. When VBASE drops to below about 0.6 V, no power is delivered to the load since this voltage is too low to cause base current to flow.

The PA consists of two separate Hybrid Cascode sections connected at the collector bus. Each section is made up of a single power MOSFET driving the emitters of three bipolar transistors. Each bipolar base has its own base current control network which is driven from a common VBASE supply. Each collector and each base is separately fused, allowing a failed part to disconnect itself from the circuit without seriously affecting performance. Failure of either power MOSFET will reduce the RF power available by about half, since the working half will continue to operate.

Voltage snubbing networks protect VGATE, VBASE, and the power MOSFET drains from being damaged in the event of any transistor failure. This limits the extent of failure damage. Each collector is equipped with a diode which allows the voltage on the output bus to swing negative with respect to ground, as it does in all monopolar modes of operation at sufficiently high power and load resistance.

In Cut modes, VGATE is a fixed frequency rectangular pulse and VBASE is varied from about 0.3 to +8.5 Vdc to control output power. The same is true in Blend except that VGATE is further modulated to produce dead time with no output. In Monopolar Coag Modes, Standard and Spray, VBASE is fixed while VGATE is varied in length. This variation in conduction time controls the amount of energy stored in the inductive part of Z1 every cycle and therefore varies the output power level. Bipolar Coag Mode

uses a fixed VBASE and varies the number of pulses per cycle period to control output power.

3.7 RF Output Section

Refer to Schematic 4.6. RF output power may be supplied through one of two RF isolation transformers, as selected by the Bipolar relay, A5K6. When de-energized, K6 connects the power amplifier collector bus to the Monopolar output transformer, T3, which is resonated by C28 and C29 and damped by A9R2. The main secondary of T3 is capacitively coupled by C41 and C30 to the patient plate output jack and via high-voltage reed relays, to the user selected monopolar active accessory connectors. An auxiliary single-turn T3 secondary supplies a replica of the power amplifier collector voltage to the VSENSE circuit. This rectifies and peak-detects this signal for use by the control circuitry to limit output voltage in Cut.

When K6 is energized, it disconnects T3 and supplies the Bipolar output transformer, T1, with power from the power amplifier. The primary of T1 is resonated by C27 and is damped by A9R2. This transformer is designed to meet the particular requirements of bipolar electrosurgery which is characterized by much lower impedances and permissible voltages than those in monopolar operation. Its secondary is capacitively coupled to the appropriate output connectors. Output waveforms under various conditions are shown in Figure 3.6.

Balun transformer T6 operates to balance active and return currents and thus attenuate common-mode RF leakage in all monopolar modes.

CAUTION: Because of the high peak-to-peak amplitudes of these waveforms, use oscilloscope probes that can withstand 2 KVpp minimum for cut, 12.0 KVpp minimum for coag, and 500 Vpp minimum for bipolar.

3.8 Aspen Return Monitor (A.R.M.) Circuitry and Software

The A.R.M. Circuit converts the electrical resistance appearing in the return electrode circuit into a digital value which can be processed by the microprocessor A3U3. Software processes use this value in conjunction with the SINGLE



PAD/DUAL PAD and MONITOR SET POINT buttons to determine when a RETURN FAULT condition exists. The ASSIST Resistance Indicator is also driven by software to indicate the value of the measured DUAL FOIL resistance in the 10 to 150 ohm range.

Portions of this function are implemented on the A3 Controller PWB and on the A5 Output PWB.

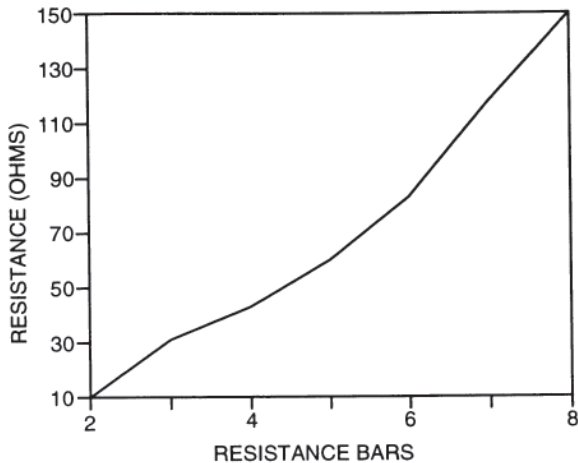


FIGURE 3.4

Figure 3.4 shows the approximate resistance vs. number of illuminated bars in the resistance indicator. If no bars are lit, then the resistance is less than approximately 10 ohms, if 10 bars are lit, the resistance is greater than approximately 150 ohms. It is not possible for just 1 or 9 bars to be lit, unless a bar segment has failed.

Schematic 4.6 contains the ARM Circuitry on the A5 PWB. It is comprised of an oscillator section and an isolation section. The isolation section employs a shielded toroidal transformer, T5, to couple the impedance presented at return electrode plate jacks, A7J8 and J9 to the ARM oscillator, while isolating that circuit from the effects of applied RF electrosurgical current and voltage. Capacitors C44 and 45 split the return current evenly between the two legs, thus minimizing the RF voltage appearing across T5 windings. T5 also acts to step up the return circuit impedance by about 10:1. The shield serves to prevent the RF stray magnetic field generated by the monopolar output transformer, T3, from interfering with the ARM circuitry during RF activation.

The A.R.M. oscillator generates a low-power sine wave voltage of about 36 KHz. This frequency is determined by the inductance of T4 in parallel with the capacitance presented by C21 - 23, and that of C44 and C45 reflected through T5. Transistors Q2 and Q3 are cross-coupled via R7 and R8, so that when one transistor is conducting, the other is fully turned off due to lack of base drive. The conducting transistor turns off at the next zero-crossing of the sinusoidal voltage on the primary of T4. This allows its collector voltage to rise and thus provide base current to the other transistor to turn it on. In operation, the collector voltages appear like half-wave rectified ac, with each collector 180 degrees out of phase with the other. See Figure 3.7.

The A.R.M. oscillator is powered by a constant 0.5 mA dc current driven from the A3 PWB via the VARM signal line. This current feeds into the center tap of T4 primary. The voltage on the center tap is the average of the two collector voltages, so it appears as a full-wave rectified sine wave with a peak amplitude of one-half that on either collector. Inductor L1 helps hold the current fed to T4 constant regardless of these voltage variations, while C15 serves as a bypass to limit the noise conducted from the A5 PWB up the VARM line to the A3 PWB.

The A.R.M. oscillator is a dc-to-ac power converter, with its major losses appearing as resistors in parallel with the resistance of the return electrode circuit, R1, transformed up through T4 and T5. In effect, the A.R.M. oscillator transforms R1 into an equivalent dc resistance, R_{in}, appearing at the VARM input to the circuit. Thus when R1 is very high, as when no connection is made to the Return electrode jacks, R_{in} is maximum, allowing the VARM voltage to rise to +2.3 - 3.0 Vdc.

When R1 falls into the 10 to 150 ohm range normally encountered with a properly applied dual-foil electrode, R_{in} also drops and VARM falls into the 1.0 to 2.5 V range. If R1 is very low, as when a single foil electrode is connected, VARM drops to about +0.8 Vdc. Resistors R11 and R12 serve to set a lower limit to the resistance applied across T4's secondary. Without this lower limit, the effective short circuit presented by a single foil return electrode would reduce the Q of the 37 kHz tuned circuit to the point that the oscillator would behave erratically. Thus VARM



varies directly with the resistance appearing in the return electrode circuit. The relationship is essentially logarithmic, with increases in VARM becoming vanishingly small as RI rises above 1000 ohms. This means that VARM will change by a nearly constant voltage for a given percentage change in RI anywhere in the 10 to 150 ohm range.

The balance of the A.R.M. Circuitry resides on the A3 Controller PWB, Figure 4.4b. Diode VR2 is a +1.235 V regulator whose output voltage appears across the 2.49K resistor R47, thus driving a constant current of 0.5 mA into the VARM line. R48 allows the circuit to operate to ground, while R40 and C38 act as a low-pass noise filter. The voltage BVARM at U21-8 is essentially equal to VARM, since that opamp is connected as a high-input-impedance voltage follower.

The digital-to-analog converter, DAC U19, is driven by the microprocessor to produce 0.0 to +2.55 Vdc at U19-16. This voltage is compared to BVARM by comparator U23 to drive ARM-COMP at U23-13. Every 12 msec, the microprocessor reads the ARMCOMP line in response to a sequence of DAC voltages, determined by a successive approximation algorithm, to measure the VARM voltage to a precision of 10 mV. This value is then processed along with the VARM values for 10 and 150 ohm return circuit resistances stored in the NOVRAM during the last Pad Calibration to evaluate the current RI.

The Return Fault process works on a 50-point (0.6 sec) average VARM value. If Single Foil Mode is selected, the microprocessor will declare a Return Fault when VARM indicates that RI is 10 ohms or greater. The ASSIST Resistance Indicator is always dark in this mode.

In Dual Foil Mode, the ASSIST Resistance Indicator will be illuminated to indicate RI in the range of 10 to 150 ohms. At just over 10 ohms, the two left bars are illuminated. As VARM increases, additional bars are illuminated in proportion to VARM, progressing to the right, until RI approaches 150 ohms, where eight bars are illuminated. When RI exceeds 150 ohms, all ten bars are illuminated. Whenever a Return Fault condition exists, all illuminated bars will flash, but RI is still displayed as above. Figure 3.4 illustrates

the relationship between RI and the ASSIST Resistance Indicator bars.

In Dual Foil Mode, the microprocessor declares a Return Fault if RI is less than 10 ohms or greater than 150 ohms. If VARM is within the allowed range, then the Return Fault Indicator will turn off when the Alarm Set Point Key is pressed, and the present value of VARM is stored for reference. A new Return Fault will be declared if RI rises about 20% above this stored value or goes out of the allowed range.

This rise indicates significant electrode detachment. A Return Fault declared in this case will NOT automatically be cleared if the patient resistance drops back to near the stored value. The Alarm Set Point Key must again be pressed to register the staff's satisfaction that the electrode attachment is safe before turning off the alarm.

Because patients' and return site resistances vary over a considerable range, it is not safe to assume that any in-range resistance indicates safe electrode attachment. For example, a poorly placed electrode on a well-perfused site can show the same resistance as a safely attached electrode on adipose tissue. Yet the poorly placed electrode could still result in a burn due to low contact area. The clinical staff is responsible for the final judgment of safe return electrode placement.

3.9 Continuity Detector

The Continuity Detector provides isolation by both magnetic and optical coupling. Schematic 4.6 includes a schematic of the continuity detector. A 90 kHz oscillator, A5U4, generates a 20% duty-cycle rectangular wave drive to transistor A5Q1, which drives the resonant primary circuit of a toroidal isolation transformer, A5T2. See Figure 3.7. The energy coupled to the secondary windings is rectified and filtered to produce an isolated 3 to 4 Vdc source for each of the three separate RF output circuits (BIPOLAR, H1, and H2). The bipolar hand switch continuity detector will be used as an example, since all sections are identical. When the bipolar hand switch is closed, dc current limited by RI flows through the LED in the optical isolator U1. This produces a beam of light which falls on the phototransistor in U1, causing it to draw collector current. This current pulls the signal line /HBP to a



low voltage, and this state is interpreted by the microprocessor as a closure of the switch. When the hand switch is released, the LED goes dark causing the phototransistor to cease conduction and allow the signal line to be pulled to a high state by resistor network A3RN1. A5C3 bypasses any RF currents around the bipolar accessory switch than may occur due to reverse accessory connection while blocking dc from the U1 LED when the accessory switch is open.

3.10 Footswitch Isolation

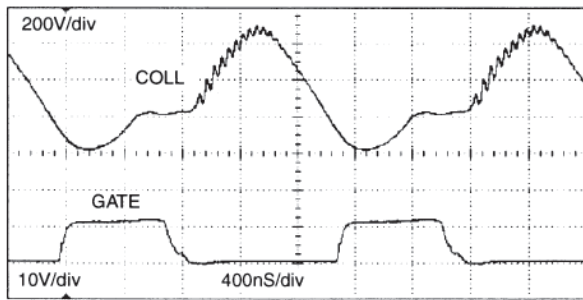
The Footswitch Isolation Assembly, A10, provides isolation from ground for the monopolar and bipolar footswitches. This isolation is required to prevent activation in case either side of the switches are shorted to ground. The exposed metal of the switches is grounded, how-

ever. This assembly is mounted to the top cover RF shield. It is inconvenient to work on the A3 assembly with A10 in its normal position. To facilitate that, one can easily bypass the A10 assembly by disconnecting the connector from footswitches to A10, and the cable from A10 to A3. Connect the cable from the base to A3P7 (the same plug the A10 cable was using). Be sure to restore original connections before returning unit to service to provide the required isolation.

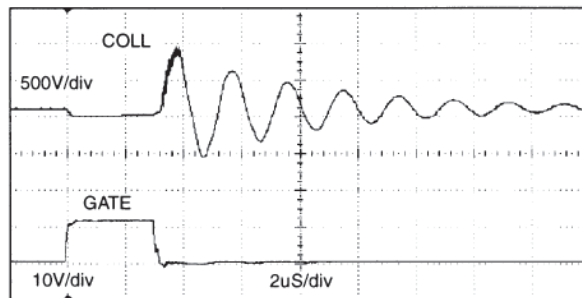
Power is provided through the line power isolation transformer A10T1, where it is rectified (D1, D2) and filtered (C1) to provide the unregulated dc voltage supply. The remaining circuitry is similar in operation to the Continuity Detector (see Section 3.9), thus the theory will not be repeated.

Figure 3.5 Power Amplifier Waveforms

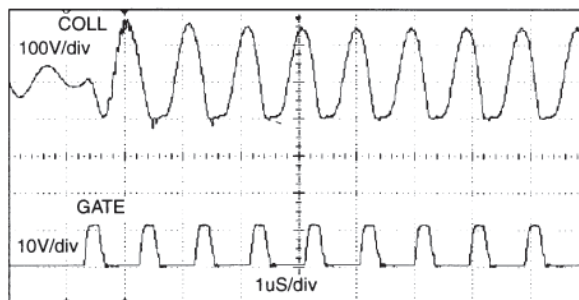
The following waveforms are representative of those which appear in the Excalibur Plus PC™ Power Conversion Assembly at the collector bus COLL (A4TP2) and the GATE (A4TP4).



Monopolar Pure, 300W, Open Circuit



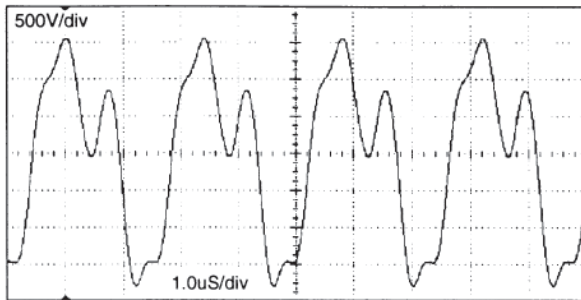
Monopolar Spray Coag, 80W, Open Circuit



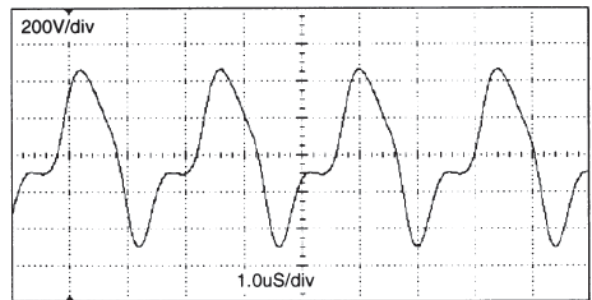
Bipolar Coag, 50W, Open Circuit



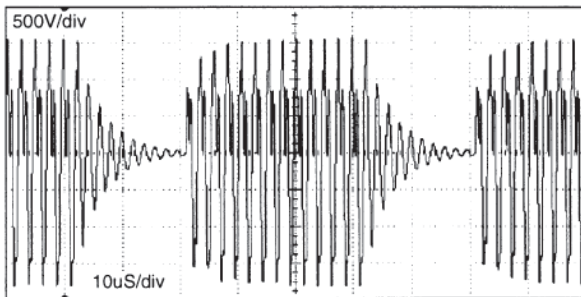
Figure 3.6 RF Output Voltage Waveforms



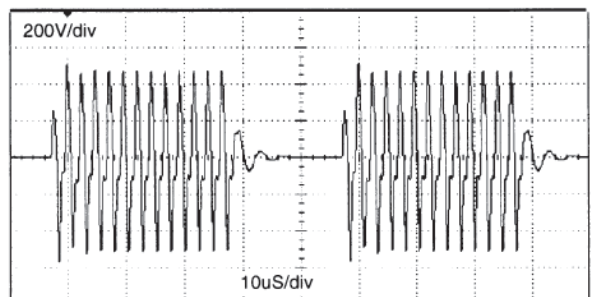
Monopolar Pure, 300W, Open Circuit



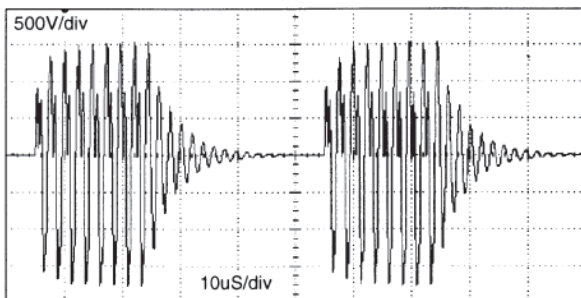
Monopolar Pure, 300W, 300 ohm load



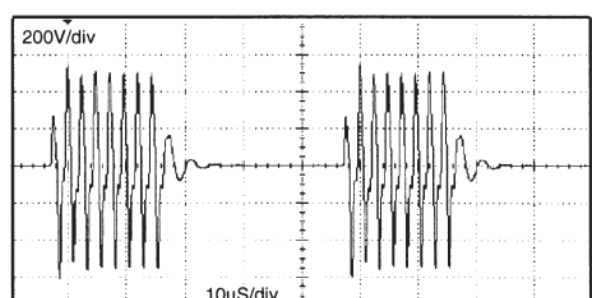
Monopolar Blend 1, 180W, Open Circuit



Monopolar Blend 1, 180W,
300 ohm load



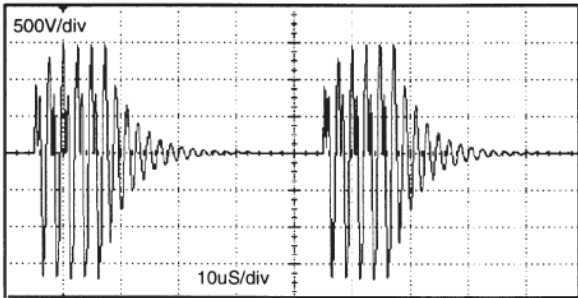
Monopolar Blend 2, 120W, Open Circuit



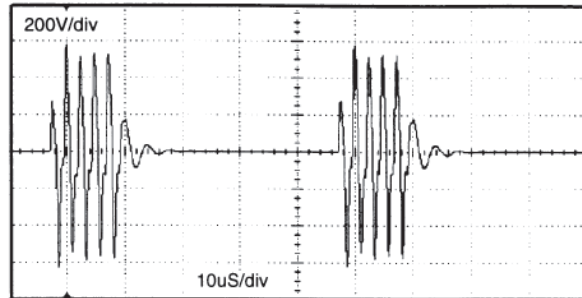
Monopolar Blend 2, 120W,
300 ohm load



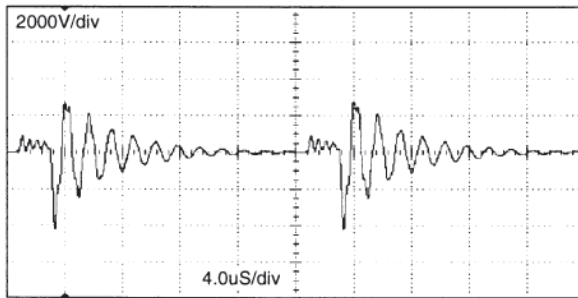
Figure 3.6 RF Output Voltage Waveforms, cont'd.



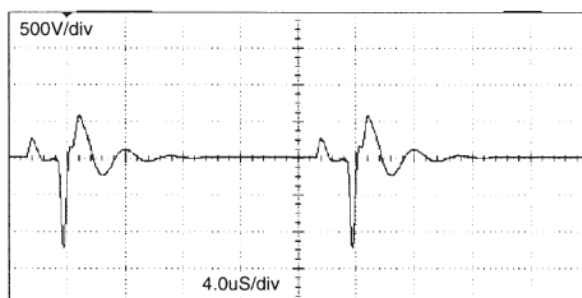
Monopolar Blend 3, 80W, Open Circuit



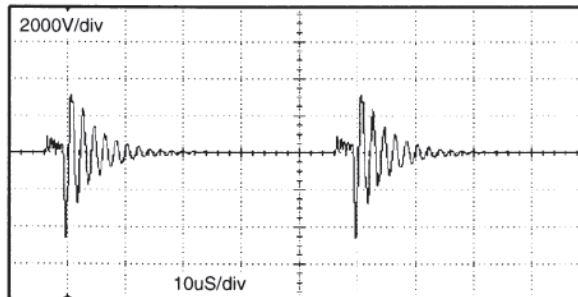
Monopolar Blend 3, 80W, 300 ohm load



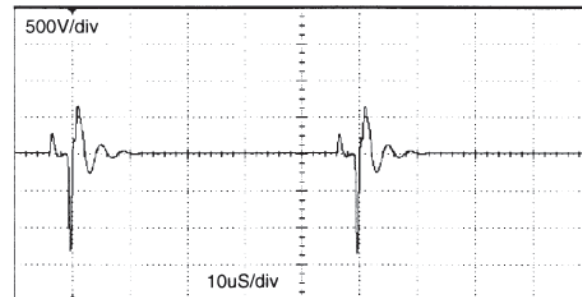
Monopolar Standard Coag, 120W,
Open Circuit



Monopolar Standard Coag, 120W,
300 ohm load



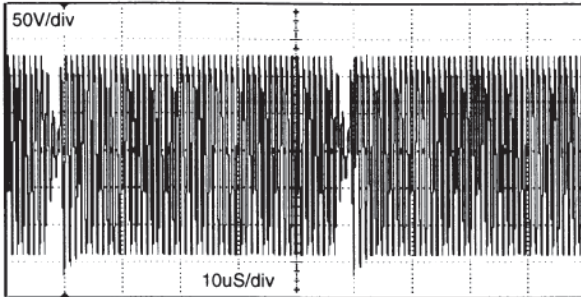
Monopolar Spray Coag, 80W,
Open Circuit



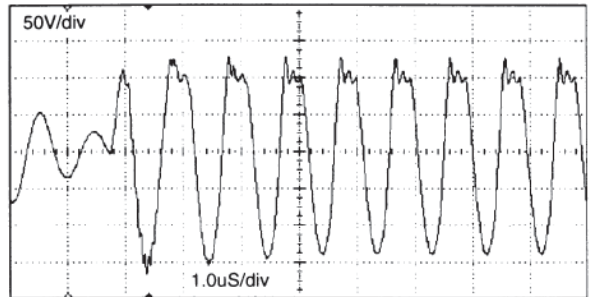
Monopolar Spray Coag, 80W,
500 ohm load



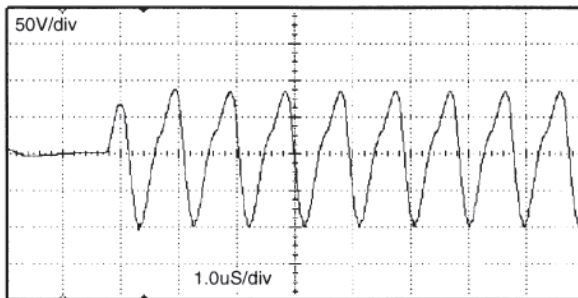
Figure 3.6 RF Output Voltage Waveforms, cont'd.



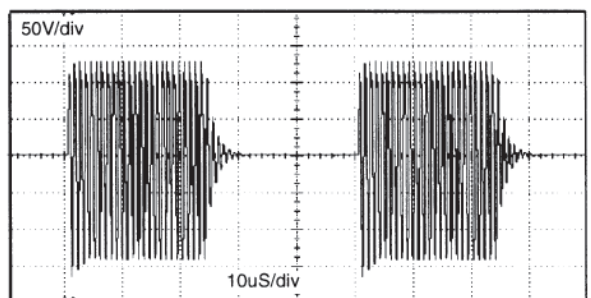
Bipolar Coag, 50W, Open Circuit



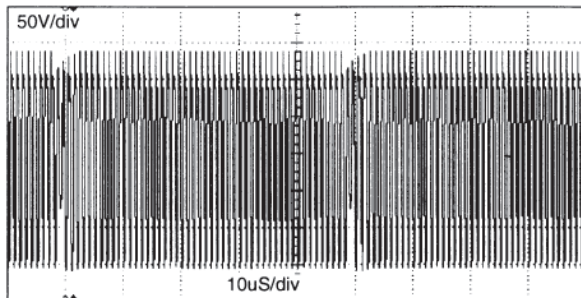
Bipolar Coag, 50W, Open Circuit, Expanded Scale



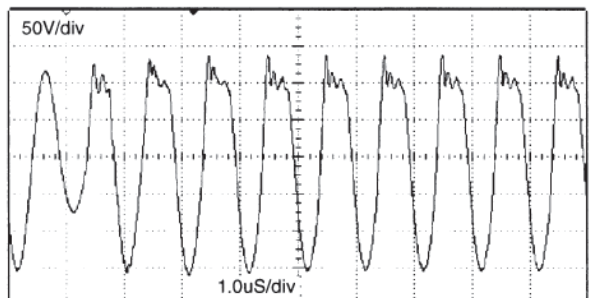
Bipolar Coag, 50W, 50 ohm load, Expanded Scale



Bipolar Coag, 25W, Open Circuit



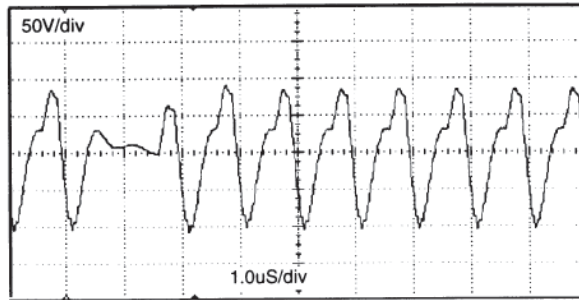
Bipolar Cut, 50W, Open Circuit



Bipolar Cut, 50W, Open Circuit, Expanded Scale

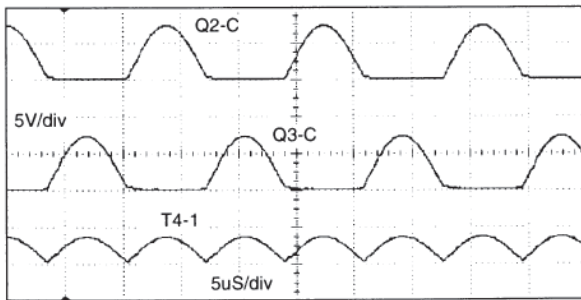


Figure 3.6 RF Output Voltage Waveforms, cont'd.

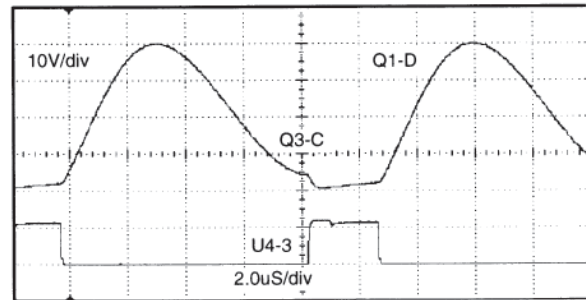


Bipolar Cut, 50W, 50 ohm load,
Expanded Scale

Figure 3.7 Miscellaneous Waveforms



A.R.M. Oscillator Waveforms
(Output Board)



Continuity Detector Waveforms
(Output Board)



Maintenance

Section 4.0

4.1 GENERAL MAINTENANCE INFORMATION

This section contains information useful in the maintenance and repair of the Excalibur Plus PC™. While the unit has been designed and manufactured to high industry standards, it is recommended that periodic inspection and performance testing be performed to ensure continual safe and effective operation.

Ease of maintenance was a primary consideration in the design of the Excalibur Plus PC™. Maintenance features of this unit include micro-processor aided troubleshooting aids and push button calibration, built in fault detection, circuit protection, easy access to circuitry while the unit is operational, and fused, screwdriver replaceable power transistors. These features coupled with the warranty, local support, loaner equipment, factory support, toll free phone service to the factory and available factory training ensure the user of a minimal maintenance effort with extensive support available.

4.2 ASSEMBLY BREAKDOWN & PARTS ACCESS

>WARNING<
HAZARDOUS VOLTAGES ARE PRESENT ON INTERNAL COMPONENTS. BE SURE THAT THE UNIT IS TURNED OFF AND THE POWER PLUG IS DISCONNECTED BEFORE DISASSEMBLY.

The Excalibur Plus PC™ opens into a Base Assembly and a Top Cover Assembly. To gain access to the internal parts remove the two Phillips head screws on the Rear Panel. Refer to Figure 4.1. Slide the Top Cover forward and lift its front edge. The Top Cover can be held open vertically by sliding the Rear Support Bracket Slots onto the top edge of the Rear Panel Base Assembly. See Figure 4.2. To close the Top Cover, lift it upward until the Support Bracket

Slots are free and then lower it onto the Base Assembly. Reengage the Front Closure Pins into the Base Assembly slots before replacing the rear screws.

>WARNING<
HAZARDOUS VOLTAGES ARE PRESENT ON ALL BASE SUBASSEMBLIES WHEN THE UNIT IS OPERATING.

NOTE: The Excalibur Plus PC™ may be operated with the Top Cover open and the RF Shield removed for test purposes. Avoid drawing arcs with the RF Shield removed. Failure to replace the RF Shield when returning the unit to service may cause erratic operation and/or cause error codes to occur.

4.2.1 Display PWB A2

To gain access to the Display Assembly A2, remove the nine nuts attaching the RF Shield to the Top Cover. See Fig. 4.2. Access to the component side of the A2 Display Assembly is gained by removing the five screws. See Fig. 4.3. Verify cable connections when reinstalling the Display PWB. When replacing the RF Shield take care not to pinch any of the cables.

CAUTION: Many of the components on the A2 and A3 assemblies are static sensitive. Take appropriate precautions when servicing these boards.

4.2.2 Controller Assembly A3

To gain access to the Controller PWB A3, remove the RF Shield. See Fig. 4.2. Access to the circuit side of the A3 Controller Board is gained by removal of the six fasteners and eight cable connections. Verify cable connections when reinstalling this board. Take care not to pinch any of the cables when replacing the RF Shield.



4.2.3 Power Conversion Assembly A4

The Power Conversion PWB A4 contains the A4 PWB and the six Power Transistors. See Figure 4.3. Refer to Section 4.7.8 for precautions to be taken when replacing these devices.

Most A4 PWB components may be replaced without removing the A4 Assembly from the unit. Removal of A4C8, C9, C11, and C20 can be accomplished by removing the A4 PWB. It should be removed as a unit including the heatsinks. Removal is accomplished by removing the heatsink mounting fasteners and five harness connections. See Figure 4.3. When replacing this assembly, tighten all heatsink mounting fasteners before tightening the PWB fasteners.

CAUTION: This assembly is fragile when not mounted in the unit. Do not bend or flex the A4 assembly.

4.2.4 Output Assembly A5

Removal of A5 the Output PWB is accomplished by removing ten cable connections, three screws and unsnapping the four plastic support posts. Refer to Figure 4.3.

4.2.5 Power Transformer and Resonating Capacitor

Refer to Schematics 4.1 and 4.7. The ferroresonant power transformer A9T1 and its resonating capacitor A6C1 are conservatively rated and are unlikely to require replacement due to failure. The most common reason for replacing these components is to change mains frequency. Consult the factory for information on changing the mains frequency. The Excalibur Plus PC™ should be operated ONLY at the mains frequency marked on the unit's Nameplate.

Transformer A9T1 is supplied with captive, self-locking nuts in each of its four feet. The feet are secured to the bottom of the Base Assembly with Allen-head screws and lock washers through vibration isolating grommets.

Primary and secondary electrical connections to A9T1 are via leads terminated on A6, TB1 and

TB2. A lead number is printed on each of these wires which corresponds with its terminal number on TB1 and TB2.

The transformer frame is grounded via a green-yellow wire with a ring lug secured to a grounding stud on the bottom of the Base Assembly.

The two red resonating winding leads, #5 and #6, connect to A6C1 via slip-on connectors accessible after pulling up the insulating boot.

Capacitor A6C1 is secured to the Rear Panel Assembly by a strap.

4.2.5.1 Primary Strapping

The unit may be adapted to various mains voltages by changing connections on A6TB1 and replacing A9CB1. Figure 4.1 and 4.7 illustrate the variations available for each model. If possible, reuse the factory supplied wires. Note that the transformer and its accompanying capacitor must be changed between 50 and 60 Hz only versions. Otherwise use #18 AWG stranded wire with 300 V, 80° C insulation or better. Ensure that all strands are inserted into the terminals before tightening the terminal screws. Chassis leakage tests per Section 4.5.6 should be conducted after restrapping to verify the safety of the unit.

4.2.5.2 Replacing A9T1 and A6C1

A9T1 and A6C1 can only be ordered and replaced as a unit. A6C1 may be removed by disconnecting red leads A9T1-5 and -6 and loosening one of the strap mounting nuts enough to permit the capacitor to slide out. Before removing the A9T1 mounting screws, disconnect all of the transformer leads from A6TB1 and TB2, the frame grounding lead from the grounding stud. Replace the other grounding lugs which also are connected to this stud and loosely reinstall the nut.

Disconnect and remove A6C1. On 50-60 Hz units, disconnect A4P4 and the OVP sense connections at A6BR1, A6BR2 and the lugs connecting to A6W1. Reconnect A6W1 lugs to the proper terminals on A6BR1 and A6BR2 to aid correct reassembly.



Close the top cover, tip the unit backwards and remove the two mounting screws and flat washers nearest the front of the unit. The transformer will rest against the Rear Panel. Return the unit to its normal operating position and place it on a workbench with the rear panel projecting past the edge only far enough to gain access to the two rear transformer mounting screws.

After all four mounting screws and flat washers have been removed, carefully lift A9T1 out of the unit, rotating it forward to prevent damage to the A4 PWB or nearby harnesses and components. Avoid disturbing the routing of harnesses.

Before installing A9T1, remove any debris which may have accumulated under the transformer and inspect the vibration isolation grommets for damage and proper insertion in the Base Assembly. Torn or missing grommets should be replaced before installation of A9T1.

If the replacement transformer leads have not been trimmed and sleeved, cut and strip each lead to the same length as on the transformer which was removed. DO NOT tin the stripped ends. Sleeving from the old transformer may be reused if not damaged. Cable ties on the secondary leads are most easily installed after the transformer is mounted and reconnected.

Installation of A9T1 and A6C1 is in the reverse order of removal.

NOTE: The transformer mounting screws should be tightened only one-half turn beyond the point where the grommet is in contact with both the flat washer and mounting foot.

Place the green-yellow frame bonding wire on the grounding stud along with all of the other grounding lugs originally there. Tighten the nut securely.

Reconnect the primary and secondary leads to A6TB1 and 2, ensuring that each is securely connected to the proper terminal with no stray strands.

On 50-60 Hz units only, reconnect A4P1 and A4J1 and reconnect the OVP leads in their original order to A6BR1, A6BR2 and A6W1; the

male nesting lug should be oriented toward the insulated rectifier mounting nut to prevent accidental short circuits to the grounded metal rectifier case.

Install A6C1, ensuring that it is the proper value for the mains frequency marked on A9T1. Slide the capacitor down until its bottom just touches the top of the bent edge on the Base Assembly, then tighten the strap mounting nut.

Insert red leads A9T1-5 and -6 through separate holes in the boot, then reconnect the slip-ons to separate terminals on A6C1. This capacitor is not polarized, so the leads may be connected in either order.

Install cable ties on the secondary leads, if necessary. Carefully dress all transformer leads so that they are clear of sharp edges and completely below the top edge of the Rear Panel. Restore the original routing of any other harnesses which may have been moved.

Test the installation by performing the Preliminary Tests in Section 2.3, Chassis Leakage tests in Section 4.5.6, and Output Power tests in Section 4.5.3.

4.3 CLEANING

The interior of the unit may be vacuumed or blown out as required. The exterior of the unit may be cleaned by wiping it with a cloth that has been dampened (not dripping) with a mild detergent such as Windex® or Formula 409®. Windex® is a registered trademark of the Drackett Products Company. Formula 409® is a registered trademark of the Clorox Company.



Figure 4.1 Rear Panel Screw Location

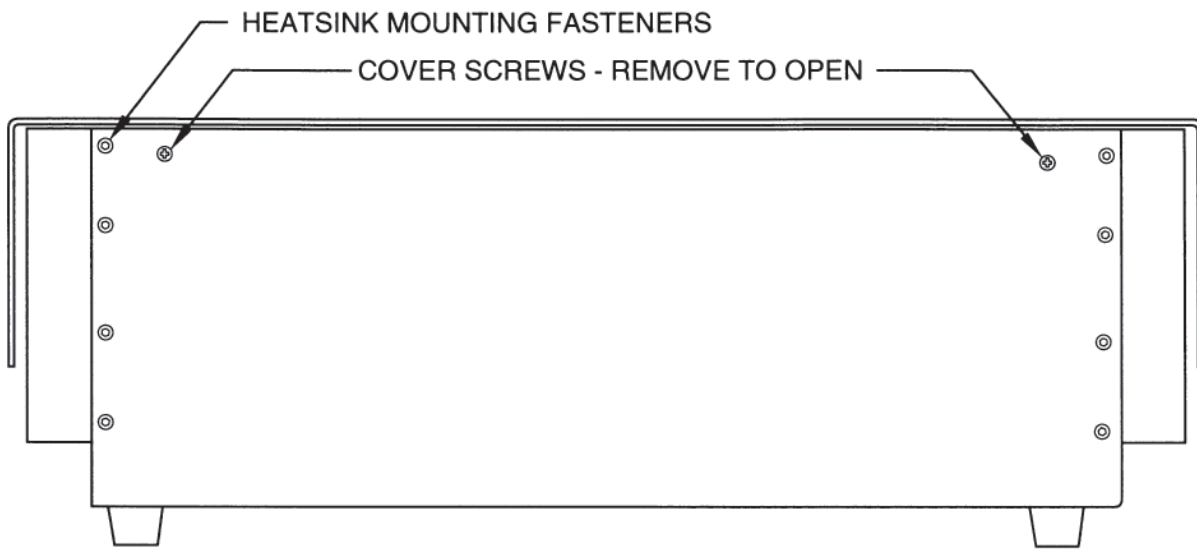


Figure 4.2 Display, Controller & Footswitch Isolation PWB Locations
(Shown with RF Shield cutaway)

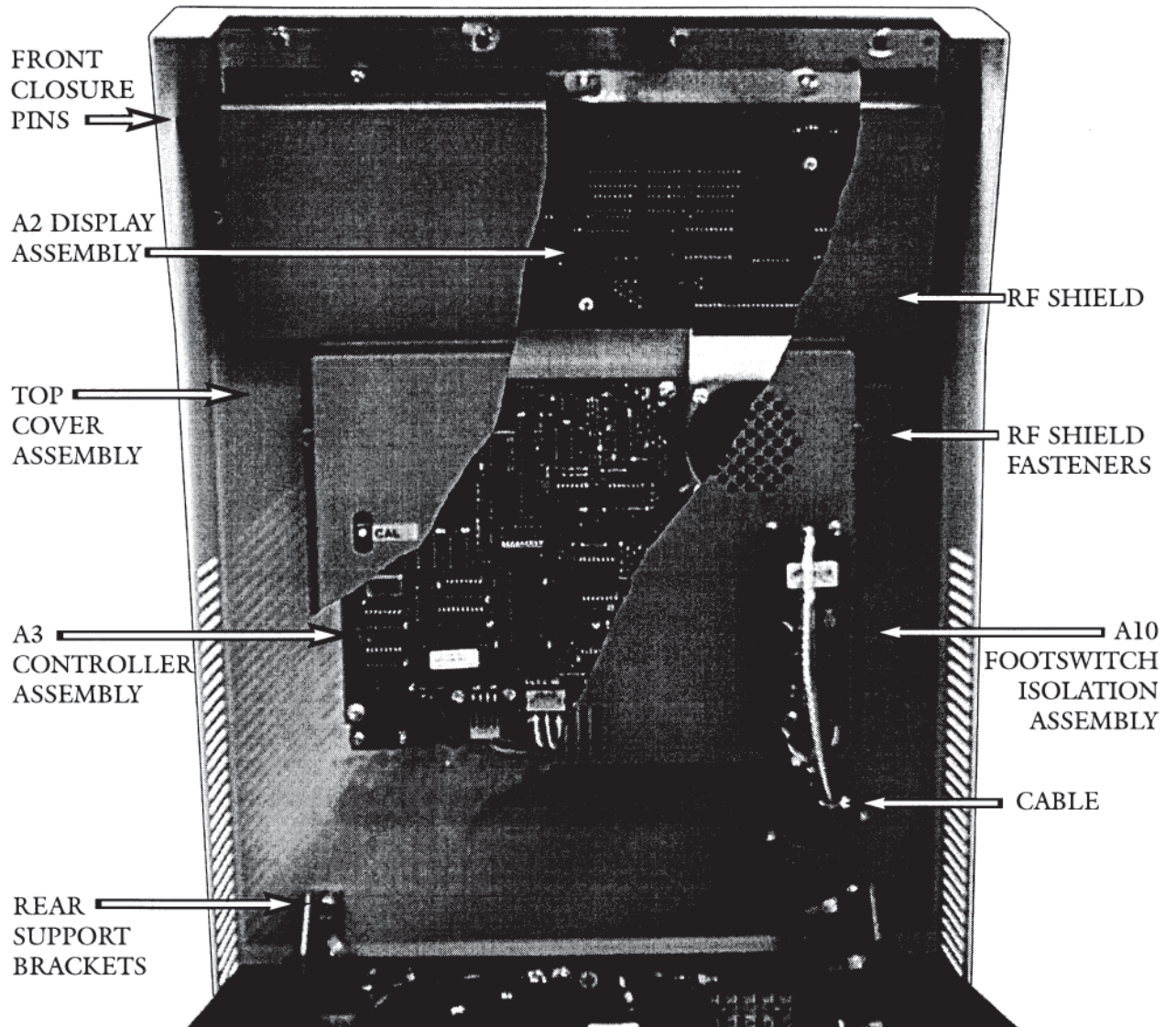
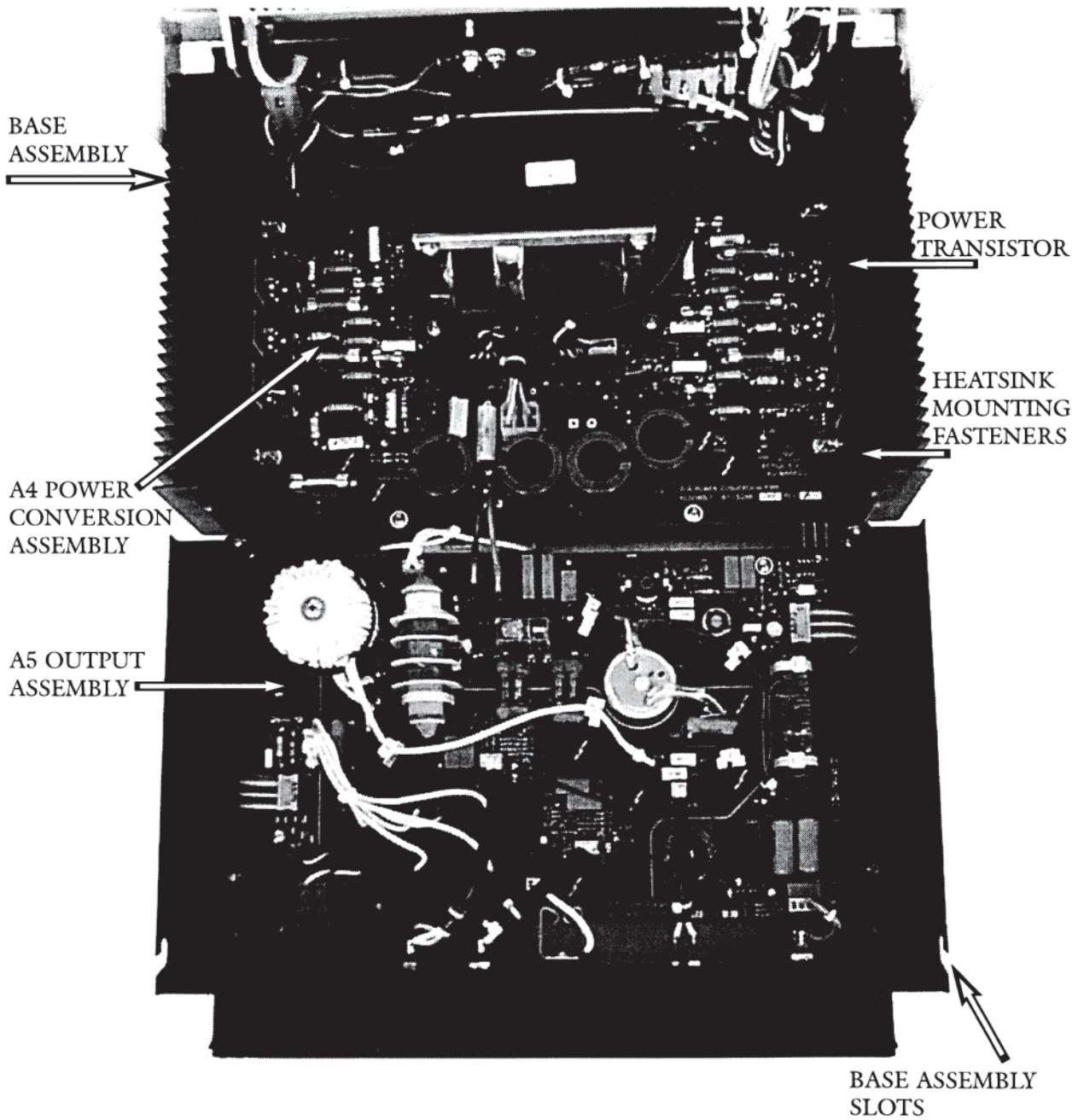


Figure 4.3 Power Conversion & Output PWB Locations



4.4 PERIODIC INSPECTION

The Excalibur Plus PC™ should be visually inspected at least every six months. This inspection should include checks for:

- Damage to the power cord and plug.
- Tightness of the power plug.
- Tightness of the volume control knob.
- Proper mating and absence of damage to the patient connectors.
- Obvious external or internal damage to the unit.
- Accumulation of lint or debris within the unit or heatsink.
- Control Panel cuts, punctures or dents.

4.5 PERIODIC PERFORMANCE TESTING

The Excalibur Plus PC™ should be performance tested at least every year. Every unit is supplied with a serialized Production Test Data Sheet that tabulates the results of the factory tests that were performed on the unit. This data is supplied so that it may be used as a reference for subsequent tests. Recommended periodic performance tests are listed in the following sections.

4.5.1 Chassis Ground Integrity

Equipment: Volt-Ohmmeter, Simpson 260 or equivalent.

Procedure: Connect the ohmmeter between the earth ground prong of the power plug and the exposed screw heads on the bottom of the Output Panel, and the Equipotential Ground Connection. Confirm less than 0.2 ohm resistance.

4.5.2 Displays, Alarms, Commands

Preliminary checks of the items listed below appear in Section 2.3.

- Return Fault Alarm
- Mode Indicator Lamps
- Sound Tones and Volume Control
- Hand control/Forceps Operation
- Foot switch Operation
- ASSIST Resistance Indicator
- Return Fault Indicator
- Power Indicators

Equipment: 2 Hand controls, Single and Dual Foil Return Electrodes, Foot switches, Jumper wire.

4.5.3 Output Power

Equipment:

- Monopolar Footswitch
- Bipolar Footswitch

Preferred:

- RF true rms millivoltmeter with 5 MHz frequency response, current probe with 1 KHz to 5 MHz frequency response and: 300 ohm 250W noninductive resistor (all monopolar modes except Spray), 500 ohm 250W noninductive resistor (Spray), 50 ohm 50W noninductive resistor (Bipolar).

Alternate:

- Commercial ESU Tester with 50 ohm for bipolar, and 300 ohm loads for monopolar.

Alternate:

- Commercial ESU Tester with 100 or 125 ohm loads for bipolar, and 400 or 500 ohm loads for monopolar.

- Return Electrode Adapter Plug (shorting).

- Bovie #12 Adapter Plug or Hand Control.

- 3 test leads, 1m max. length

NOTE: RF power measurements are difficult to achieve with accuracies better than 5%. This 5% error in reading can add to a similar 5% error induced by instrumentation error during calibration and result in an error due to instrumentation alone of 10%. To achieve the unit's rated error tolerance, it's best to use the same instrumentation to calibrate and check calibration. Since that will not be possible on new units already calibrated, allowance should be made. However, output errors of less than 20% are generally not clinically noticeable.

Note: The RF output power level checks of Table 4. 1 correct for the load regulation characteristics of the Excalibur Plus PC™. This results in output current levels that differ from the power setting when the $P=I^2R$ calculation is done at other than the rated load. Refer to the Load Regulation



Curves for details. Best results occur when rated load is used. It is not necessary to check calibration at each of the listed loads, they are there only to allow for the use of a tester that does not have the exact rated load.

Note: Bipolar is particularly sensitive to the load resistance. A 50 ohm load should be used for checking power for best results.

1. Use test leads to connect the ESU tester to the unit's return electrode jack and the footswitch controlled active jack.
2. Perform the monopolar power tests indicated in Table 4.1, depending upon the value of the load resistor used.
3. Disconnect the ESU tester from the unit.
4. Use test leads to connect the ESU tester to the units blue Bipolar Accessory Jacks.
5. Perform the bipolar power tests indicated in Table 4.1 depending upon the value of the load resistor used.

4.5.4 RF Leakage

Equipment:

- ESU Tester with RF Leakage function OR a 0-250 mA RF Ammeter and a 200 ohm 10 W Noninductive Resistor
- Patient Plate Adapter Plug
- Bovie #12 Adapter Plug
- 2 - Test leads, 1 m max. length
- 3 - Test leads, 10 cm max. length
- Wooden table approximately 1 m from floor.

Procedure:

1. Ensure that the unit is fully assembled and all fasteners are tight.
2. Place the meter and resistors on the table so that they are at least 0.5m away from the unit under test and any other conductive surface.
3. Set the unit for full power Standard Coag and Bipolar Coag. Connect the 200 ohm noninductive resistor in series with the 250 mA RF ammeter, the Equipotential Ground Connection on the Rear Panel. One at a time, connect this series combination to each RF output terminal indicat-

LOAD		300 ohms				400 ohms				500 ohms			
Mode	Set	Min Pow	Max Pow	Min A	Max A	Min Pow	Max Pow	Min A	Max A	Min Pow	Max Pow	Min A	Max A
Pure	10	7.0	13.0	0.153	0.208	8.5	15.8	0.146	0.199	9.6	17.9	0.139	0.189
	25	22.0	28.0	0.271	0.306	26.0	33.1	0.255	0.288	29.6	37.7	0.243	0.274
	120	108.0	132.0	0.600	0.663	126.6	154.7	0.563	0.622	139.3	170.3	0.528	0.584
	300	270.0	330.0	0.949	1.049	266.2	325.4	0.816	0.902	254.2	310.6	0.713	0.788
Blend 1	10	7.0	13.0	0.153	0.208	8.2	15.3	0.143	0.195	9.4	17.5	0.137	0.187
	25	22.0	28.0	0.271	0.306	5.9	33.0	0.255	0.287	29.1	37.1	0.241	0.272
	120	108.0	132.0	0.600	0.663	117.8	143.9	0.543	0.600	117.2	143.3	0.484	0.535
	180	162.0	198.0	0.735	0.812	157.0	191.9	0.627	0.693	152.9	186.9	0.553	0.611
Blend 2	10	7.0	13.0	0.153	0.208	8.3	15.4	0.144	0.196	9.3	17.3	0.136	0.186
	25	22.0	28.0	0.271	0.306	25.8	32.8	0.254	0.286	29.0	36.9	0.241	0.272
	120	108.0	132.0	0.600	0.663	104.5	127.7	0.511	0.565	101.1	123.6	0.450	0.497
Blend 3	10	7.0	13.0	0.153	0.208	8.3	15.4	0.144	0.196	9.2	17.0	0.135	0.185
	25	22.0	28.0	0.271	0.306	25.7	32.8	0.254	0.286	28.4	36.2	0.238	0.269
	80	72.0	88.0	0.490	0.542	69.8	85.3	0.418	0.462	67.4	82.4	0.367	0.406
Standard	10	7.0	13.0	0.153	0.208	7.2	13.4	0.134	0.183	7.4	13.7	0.121	0.165
	35	31.5	38.0	0.324	0.356	31.2	37.7	0.279	0.307	30.7	37.1	0.248	0.272
	120	108.0	132.0	0.600	0.663	110.4	134.9	0.525	0.581	110.8	135.5	0.471	0.521
Spray	10	7.0	12.9	0.152	0.207	7.0	13.0	0.132	0.180	7.0	13.0	0.118	0.161
	40	35.5	43.4	0.344	0.380	36.3	44.3	0.301	0.333	36.0	44.0	0.268	0.297
	80	70.4	86.0	0.484	0.535	72.0	87.9	0.424	0.469	72.0	88.0	0.379	0.420
LOAD		50 ohms				100 ohms				125 ohms			
Bip Coag	8	5.0	11.0	0.316	0.469	4.4	9.6	0.209	0.310	4.1	9.1	0.182	0.270
	20	17.0	23.0	0.583	0.678	14.7	19.9	0.383	0.446	13.9	18.9	0.334	0.388
	50	45.0	55.0	0.949	1.049	38.5	47.1	0.621	0.686	36.4	44.5	0.540	0.597
Bip Cut	8	5.0	11.0	0.316	0.469	6.3	13.8	0.251	0.372	6.6	14.5	0.229	0.340
	20	17.0	23.0	0.583	0.678	20.2	27.4	0.450	0.523	20.8	28.1	0.408	0.475
	50	45.0	55.0	0.949	1.049	41.2	50.4	0.642	0.710	39.4	48.1	0.561	0.620

Table 4.1 RF Output Power Checks



MEASURED OUTPUT TERMINAL	ACTIVATION COMMAND	AAMI MAXIMUM LEAKAGE (mA)	IEC MAXIMUM LEAKAGE (mA)
RETURN ELECTRODE	FOOT COAG	120	90
RETURN ELECTRODE	LEFT HAND CONTROL COAG	140	100
RETURN ELECTRODE	RIGHT HAND CONTROL COAG	140	100
RETURN ELECTRODE	BOTH HAND CONTROL COAGS	150	N/A
FOOT ACTIVE	FOOT COAG	120	100
BIPOLAR TOP	FOOT BIPOLAR	20	20
BIPOLAR BOTTOM	FOOT BIPOLAR	20	20

Table 4.2 RF Leakage to Ground Tests

ed in Table 4.2, and activate the unit using the corresponding command. Confirm that no meter readings exceed the specified maximum. Hand control coag activations are accomplished by connecting a jumper between the lower black jack and the red jack of the desired hand switchable accessory jack.

>WARNING<

HAND CONTROL ACTIVATIONS SHOULD BE KEYED USING 3" OR LESS WELL INSULATED JUMPER(S). USE OF AN INSULATING ROD TO INSERT THE JUMPER IS ADVISED TO PREVENT RF BURNS.

4.5.5 RF Leakage From Inactive Outputs

Equipment: Same as in Section 4.5.4

Procedure:

1. Set the unit for full power Standard Coag and Bipolar Coag. Connect the 200 ohm, noninductive resistor in series with the 250 mA RF ammeter. One at a time, connect that series combination between the return electrode connector and

each RF output terminal shown in Table 4.3, and activate the unit using the corresponding command. Confirm that no meter readings exceed the specified maximum. Hand control coag activations are accomplished by connecting a jumper between the lower black jack and the red jack of the desired hand switchable accessory jack. Repeat test using Spray Coag at full power.

>WARNING<

HAND CONTROL ACTIVATIONS SHOULD BE KEYED USING 3" OR LESS WELL INSULATED JUMPER(S). USE OF AN INSULATING ROD TO INSERT THE JUMPER IS ADVISED TO PREVENT RF BURNS.

CAUTION: TO AVOID DESTROYING THE METER, NEVER ACTIVATE OUTPUT TERMINAL CONNECTED TO THE METER.

2. Disconnect the meter and resistor from the unit. Turn unit Power Switch OFF.

MEASURED OUTPUT TERMINAL	ACTIVATION COMMAND	MAXIMUM LEAKAGE (mA)
FOOT ACTIVE	LEFT HAND COAG	50
FOOT ACTIVE	RIGHT HAND COAG	50
FOOT ACTIVE	FOOT BIPOLAR	20
LEFT HAND ACTIVE	FOOT COAG	50
LEFT HAND ACTIVE	RIGHT HAND COAG	50
LEFT HAND ACTIVE	FOOT BIPOLAR	20
RIGHT HAND ACTIVE	FOOT COAG	50
RIGHT HAND ACTIVE	LEFT HAND COAG	50
RIGHT HAND ACTIVE	FOOT BIPOLAR	20

Table 4.3 RF Leakage for Inactive Outputs Test



4.5.6 Line Frequency Leakage

Equipment: These tests are performed most conveniently using any good quality biomedical electrical safety tester. If you do not have such a tester, then it is possible to construct your own using a millivoltmeter and a simple RC network constructed according to IEC 60601-1, Clause 19.4 c).

1. Connect the electrical safety analyzer to make the measurements indicated in Table 4.4.
2. Since the Excalibur Plus PC monopolar active outputs are disconnected by relays when the unit is not activated, active-to-neutral leakage tests must be performed with the unit activated in order to be valid.

CAUTION: To prevent RF current from destroying the test equipment and/or affecting leakage readings, set all power settings to zero.

3. With all power controls set to zero, measure the leakage current as in step 1 from each of the three active output terminals to neutral (see Table 4.5) while that output is activated in Cut by the appropriate footswitch or hand control jumper. Hand control cut activations are accomplished by connecting a jumper between the lower black jack and the red jack of the desired hand switchable accessory jack.

Leakage Path	Line Polarity	Case Ground	Test Limit
Bipolar-Neutral	Normal	Closed	5uA
Bipolar-Neutral	Normal	Open	5uA
Bipolar-Neutral	Reversed	Closed	5uA
Bipolar-Neutral	Reversed	Open	5uA
Return Electrode-Neutral	Normal	Closed	5uA
Return Electrode-Neutral	Normal	Open	5uA
Return Electrode-Neutral	Reversed	Closed	5uA
Return Electrode-Neutral	Reversed	Open	5uA
Chassis-Neutral	Normal	Open	40uA

Table 4.4 Unkeyed Line Frequency Leakage Tests

Leakage Path	Line Polarity	Case Ground	Test Limit	
Foot	Active-Neutral	Normal	Closed	5uA
Controlled	Active-Neutral	Normal	Open	5uA
	Active-Neutral	Reversed	Closed	5uA
	Active-Neutral	Reversed	Open	5uA
	Hand Control 1	Active-Neutral	Normal	Closed
Active-Neutral		Normal	Open	5uA
Active-Neutral		Reversed	Closed	5uA
Active-Neutral		Reversed	Open	5uA
Hand Control 2	Active-Neutral	Normal	Closed	5uA
	Active-Neutral	Normal	Open	5uA
	Active-Neutral	Reversed	Closed	5uA
	Active-Neutral	Reversed	Open	5uA

Table 4.5 Keyed Line Frequency Leakage Tests



4.5.7 Aspen Return Monitor (A.R.M.) Calibration Check

This section describes the method to check the calibration of the A.R.M. circuitry.

Equipment: Decade Resistance Box (DRB) with attached dual foil return electrode cable. The DRB must be adjustable from 0 to 160 ohms in 1 ohm steps and accurate to 1%. A dual foil return electrode cable can be made by cutting the cable to about 3 ft. from the connector from a dual foil return electrode, and stripping the wires for connection to the DRB.

NOTE: Some DRBs may present a brief open circuit at the output terminals during switch movement. This may cause the A.R.M. software to calculate an erroneously high resistance reading. This effect may be minimized by making DRB setting changes quickly. If the resistance read during any of the following tests is above the upper limit, repeat the test carefully stopping in each 1 ohm step for at least 1 second.

Procedure:

1. Disconnect all accessories from the Excalibur Plus PC™ front panel.
2. Power up the Excalibur Plus PC™ in the RUN Mode, and confirm that ASSIST Resistance Indicator has all 10 green bars flashing, and that the Return Fault Indicator and the Dual Foil Mode Indicator are illuminated.
3. Using the test cable, connect the DRB to the Return Electrode Jack.
4. Carefully advance the DRB in 1 ohm steps until all 10 bars of the ASSIST Resistance Indicator are flashing. Confirm that the DRB reads between 137 and 163 ohms.
5. Set the DRB to 7 ohms and confirm that the ASSIST Resistance Indicator is dark and the Return Fault Indicator is lit.
6. Select Single Foil Mode. Confirm the ASSIST Resistance Indicator stops flashing and the Return Fault Indicator is not illuminated.
7. Increase the DRB in 1 ohm steps until an audible Return Fault Alarm is sounded and the Return Fault Indicator is lit. Confirm the DRB is between 8 and 12 ohms.
8. Decrease the DRB setting in 1 ohm steps until

the Return Fault Indicator goes dark. Confirm that the DRB reads from 1 to 4 ohms less than the resistance read in Step 7.

9. Disconnect the DRB. This completes the A.R.M. calibration test. If any readings were only slightly out of range, first check the DRB with an accurate ohmmeter. If the DRB is accurate, recalibrate the A.R.M. limits in CAL Mode. See Section 4.6. If one or more readings were far from the mark, troubleshoot the A.R.M. circuitry before attempting recalibration. See Section 4.7.6.

4.5.8 +5 Over Voltage Monitor Check

1. With power off, remove the RF shield and place a short between A3TP3 (OVCHK) and A3TP22 (+5). This will simulate the +5V supply exceeding specified limits.
2. Turn unit on and confirm unit fails power-on self-test (POST) and goes to an Err 22.0 (VBASE too low during POST). This occurs because the simulated overvoltage turns VBASE off.
3. Remove jumper, replace shield, and confirm unit powers up normally.

4.6 Calibration and Adjustments

The Excalibur Plus PC™ is calibrated without selecting or adjusting components. Instead, calibration factors necessary to compensate for unit-to-unit circuit variations are stored digitally in a battery backed Nonvolatile Random Access Memory or NOVRAM A3U2. The battery has a lifetime of 10 years.

A special operational mode, called CAL Mode, permits the NOVRAM data to be updated to compensate for circuit performance changes due to aging or replacement of components. In CAL Mode, the microprocessor guides the technician to simplify and expedite a complete and accurate recalibration.

CAL Mode also provides microprocessor aided diagnostics modes to help troubleshoot hardware problems which disable the unit in normal service, and can display the last fault code.



NOTE: CAL Mode should not be used to perform routine calibration checks. Those tests are better conducted in RUN Mode per Section 4.5. If the unit proves to be out of calibration, the possibility of a component failure should be eliminated as the cause before recalibrating. Once the physical condition of the unit has been confirmed, then CAL Mode may be entered to correct the calibration.

4.6.1 CAL Mode Entry

CAUTION: Do not enter CAL Mode without first reading and understanding the following material and ensuring that the necessary equipment is on hand and accurate. Improper calibration procedures can cause an otherwise serviceable unit to become unusable until calibration is corrected.

The CAL Mode is entered by powering up while pressing the internal CAL switch, A3S1. If the key is held for more than 30 seconds, the unit will display an "Err 13.0" fault code.

Upon successful entry to CAL mode, a display check occurs for 30 seconds or until any key is pressed, and then "SLF dIA" is displayed in the Cut and Coag power windows. The Bipolar power display window shows the last two digits of the Software part number, and the Program window indicates the software revision level. After the self diagnostics are run, the unit will display "C-C, 300, A". At this time the CAL mode entry is complete and calibration or diagnostics can begin.

4.6.2 CAL Mode Menu

After entry to CAL Mode, the CUT power window will display "C-C", which is one of five available mode selections. Any of the other modes may be selected sequentially by pressing the CUT Power Increase or Decrease keys. In some of the modes, the other displays will display an option applicable to that mode; these options are similarly selectable by pressing the Increase or Decrease keys next to the display. Activating an inappropriate key or control will result in a pulsating Key Error tone. Details of how to use each mode appear in following sections. The available CAL modes, options and their uses are summarized in Table 4.6.

4.6.2.1 Entering a Mode and Returning to the Menu

When the desired Mode and Option are displayed, that mode is entered by pressing the "STORE" key. Operation in each of the modes is described in detail in following Sections.

In each of the three Calibration modes there are a number of calibration points, which may be selected, checked and adjusted. When work in a mode is completed satisfactorily, pressing the "STORE" key will save all calibration changes along with an updated CRC to the NOVRAM and will return to the menu. If the calibration is incomplete or nonmonotonic, an error code will be displayed. Pressing the "STORE" key again will restore the menu, from which the mode may be reentered.

The Diagnostics modes are removed from the menu after RF is activated in either of the Power Calibration modes. It is not possible to return to the menu from either of the Diagnostics modes without turning power off and reentering CAL mode.

4.6.2.2 Calibrated/Uncalibrated Status

If the menu MODE display for one of the three Calibration modes is flashing, then one or more points in that mode is uncalibrated. That mode should be entered and calibration completed or corrected.

Each point within a mode can be declared calibrated or uncalibrated by the microprocessor. An uncalibrated point is flagged by a flashing display. That point may be restored to a calibrated status by recalibrating.

On initial entry to CAL Mode, the unit confirms that the stored values haven't changed since the last valid calibration. If there have been any changes, all points are considered uncalibrated and a complete calibration will be required to make the unit functional. In this case, the unit does load a set of nominal calibration values which will bring a normal unit close to final calibrated values. The technician can use these values by activating the unit for each calibration point, but a real calibration should be done before returning the unit to service.



NOTE: The correct load must be connected, even if nominals are being loaded. Otherwise, the VBASE check can cause a fault in RUN mode.

After a fully calibrated mode is entered, making a change to any one calibration point will cause all of the other points in that mode which have not yet been checked to be declared uncalibrated. Those points must then be calibrated prior to returning the unit to service. This precaution is taken on the assumption that if some part of the circuitry has changed enough to justify adjustment of one calibration point, then it is likely that the other points have been affected as well.

4.6.2.3 Calibration Limits and Validity Tests

Each calibration value is based upon a VBase and Waveform drive value to set the output power. When the unit is calibrated, the VBase or Waveform value requested for the mode is adjusted for the correct power output at that calibration point. The VBase or Waveform is tested to be within ±25% of a nominal value. If the value is within the range, the calibration value is stored as calibrated, otherwise, it remains uncalibrated. At the same time, a separate VBase and Waveform average voltage is taken and stored to correspond with each calibrated point for failure analysis.

If a PAd calibration point is out of range, due either to a circuit fault or connection of an incorrect resistor to the return electrode terminals, both PAd calibration points will be declared uncalibrated. Attempts to store an out of range value in this mode will result in a Key Error alarm tone.

When the “STORE” Key is pressed to exit a Calibration mode, the unit first checks for any uncalibrated points in that mode. If any exist, then an Err 10.X code is displayed where the “X” corresponds to the mode that is not calibrated. See Appendix A. The values of all of the points remain as they were at the time of exit, eliminating the need to repeat the adjustments that were already made.

Pressing the “STORE” Key again will restore the menu, and the menu display for the partly calibrated mode will flash. The calibrated and uncalibrated status for all points in that mode is preserved while in CAL Mode, so that when the mode is reentered, it is necessary only to calibrate the flashing points to fully calibrate that mode.

Because the VBase or Waveform drive values increase steadily with increasing output power for

MODE	MODE USE	OPTIONS	OPTION USE
C-C	Monopolar (Cut-Coag) Power Calibration	300, 400, 500 A, P	RF load resistance (ohms) for monopolar calibration and display in current (A) or power (P)
bP	Bipolar Power Calibration	50, 100, 125 A, P	RF load resistance (ohms) for bipolar calibration and display in current (A) or power (P)
PAd	A.R.M. (Pad) Resistance Calibration	-blank-	
dIA	Diagnostics	1 2	Watchdog Timer Pseudo Run Mode
LFC	Read Last Fault Code	-	Check last fault code that happened in RUN mode and clear the code.

Table 4.6 Cal Mode Options



the mode, i.e., they vary monotonically with power, then calibration values stored at successively higher power calibration points in a given operational mode should increase steadily. Although the limits applied to each value can prevent disastrous numbers from being stored, the settable ranges for some adjacent points overlap. So it is possible for a lower power calibration point to be set to a larger value than its higher power neighbor. Such nonmonotonicity is indicative of a miscalibration or possible failure in the VBASE or WFG hardware, so calibration under such conditions cannot be valid.

The individual variable VBase or Waveform average voltage changes tracks the calibration value change, i.e., if the calibration value is nonmonotonic, then the VBase or Waveform average voltage is also nonmonotonic. Adjusting the calibration value for monotonicity will also store the correct VBase or Waveform since they cannot be set independently.

If nonmonotonicity is detected on exit from a Calibration mode, an Err 11.X code is displayed where the "X" corresponds to the mode that is nonmonotonic. See Appendix A for reference.

During run time, the VBase and Waveform average voltages are tested for failure every 500mS or less. Failure in either of these will result in an error code. See Appendix A.

4.6.2.4 Exiting CAL Mode

CAL Mode may be exited by turning the POWER switch OFF. This operation should only be performed AFTER returning to the main menu.

NOTE: If ANY of the modes in the menu are flashing or if there was an Err 10.X or 11.X, exiting CAL Mode will result in an immediate NOV RAM FAIL (Err 3.0) alarm on powerup in RUN mode. Complete recalibration will then be required in order to return the unit to service.

It's a good practice to be sure that each menu mode shows as calibrated (not flashing) before departing CAL or entering Diagnostics modes.

Unforeseen circuit problems which prevent a good calibration can be troubleshot in Diagnostics 2 mode. Simply enter CAL Mode, and go into Diagnostics 2. After the trouble is corrected, recalibrate the unit.

4.6.3 Output Power Calibration Procedure

The "C-C" (Monopolar Cut and Coag) and "bP" (Bipolar) modes are used to calibrate output power. The only equipment necessary to conduct power calibration is an electrosurgical output power tester having load resistances of 300, 400 or 500 ohm for Monopolar and 50, 100, or 125 ohms for bipolar and an RF rms current indicator capable of accurate measurements from 50 to 1200 mA, or power indicator capable of accurate measurements from 0 to 350 watts. These units are commercially available from a number of sources, or can be constructed using 250 watt 3% or better noninductive resistors and a selection of RF ammeters ranging from 150 mA to 2A full scale for the current indicator.

After entering a Power Calibration mode with either "A" or "P" set, the particular operational mode to be calibrated is selected by the appropriate MODE SELECT key and by the particular mode activated. For example, points in the Coag Spray mode are calibrated by selecting Spray with the COAG MODE SELECT key, and then activating the unit with the Coag foot switch or hand switch.

Each calibration point is displayed in the appropriate power window in terms of target RF output current in amps or watts (user selectable) to the selected load resistance option.

If the selected load resistance is other than the rated load, the target will deliver some other power which takes into account Excalibur Plus PC™'s typical load regulation characteristics in that mode. The actual load regulation curve for a particular unit may vary somewhat from typical, so the most accurate calibration is obtained when calibration is performed using the rated load. Bipolar is particularly sensitive to this and rated load (50 ohms) should be used if available.



Since the displayed target is computed from target power and the load resistance option, satisfactory calibration is possible ONLY if that option and the actual load resistance are the same.

Before activating a newly selected point, be sure that the tester RF full scale current or power range is at least as great as the displayed target current. Bear in mind that a unit which is far out of calibration may deliver considerably more than the target. The most accurate current readings will appear on the lowest RF current range which reads on scale for target current.

Calibration of a point consists of keying the unit and adjusting the output until the RF ammeter (or power indicator) reads as closely as possible to the displayed target. Since the amplifier drive can change only in discrete steps, it may not be possible to match the target exactly, but the setting which reads closest to the target will be within the specified tolerance.

After a point is calibrated, deactivate the unit. The last drive setting used while activated will be stored for that point. Additionally, both the waveform and base voltage drive are sampled and stored to detect over-power conditions.

With the unit deactivated, the Power Increase and Decrease keys are then used to select another calibration point. When the highest calibration point in a mode is displayed, the Power Increase key will have no further effect; the same is true for the Power Decrease key when the lowest point is displayed. This is useful in determining when a mode is fully calibrated.

It is only necessary to activate the unit for the selected point to be considered calibrated. No actual adjustment is required, but the output current (or power) should still be measured and verified against the target value.

Although the points in a Calibration mode may be calibrated in any order, it's best to use a sequence which insures that calibration is complete before returning to the menu.

4.6.3.1 Monopolar Power Calibration (C-C)

This mode permits the calibration tables for Pure Cut, Blend 1 Cut, Blend 2 Cut, Blend 3 Cut,

Standard Coag and Spray Coag to be adjusted to set output power to rated load as close as possible to the displayed power in RUN mode.

Connect the output power tester to the Return Electrode jack and one of the active RF output jacks, depending on how one wishes to activate the unit. Most Biomedics prefer to use the foot switch, in which case the tester should be connected to the foot switched controlled Monopolar Accessory Jack. If possible, set the tester for the rated load resistance, since this will yield the most accurate calibration results. If this resistance is not available, the Excalibur Plus PC™ may be calibrated to meet specifications using 300, 400 or 500 ohm loads.

Use a short alligator clip jumper (3"-6") to short A4R8 (0.1 ohm, 5W resistor) before turning unit on. Be careful not to touch other components until A4DS1 extinguishes. This jumper is only required for high power monopolar calibration, but will not affect calibration if left on throughout the entire procedure. Be sure to remove it after calibration is completed.

Connect the power plug to a source of AC power of the same frequency and within 5% of the voltage specified on the nameplate. Enter CAL Mode as described above.

When the "C-C" selection is in the CUT window, set the load resistance Option in the COAG window to match the tester load resistance and select "A" or "P" option in the bipolar window. Then press the "STORE" Key to enter the Monopolar Calibration Mode.

The Pure and Standard modes are selected by default, and the lowest power points in those modes will be displayed. Target output current is displayed in amps to the nearest 10 mA in the Cut and Coag power windows if "A" was selected. Targeted output power is displayed in watts to the nearest 1 watt in the cut and coag windows if "P" was selected.

Using the procedures described in Section 4.6.3, activate the unit in each of the points in all four operational modes, making adjustments only as required to set output current or power to match the displayed target as closely as possible.



Zero power points should be calibrated by setting the tester to the most sensitive range, then raising output until there is readable output. Find the output setting which yields the smallest perceptible output change between activated and deactivated conditions; the correct calibration setting for zero power is one step below that one.

Because heating tends to change the gain of the power amplifier slightly, a slow change in load current may be noted while the unit is activated. This may cause the unit to appear slightly off when calibration is rechecked in Run after cooling down. These errors may be minimized by allowing the unit to cool for 15 to 20 seconds between activations. Coag power calibration is affected by heating to a much smaller extent than is Cut.

This phenomenon is not ordinarily a problem unless the unit is far out of calibration, requiring extended activations in order to bring it in. In such cases, first perform a complete rough calibration. After the unit has cooled for several minutes after the last activation, repeat the calibration. Now the activation time necessary to close in on final adjustments will be very brief.

When all points have been calibrated satisfactorily, pressing the "STORE" key will store the updated values and restore the menu.

4.6.3.2 Bipolar Power Calibration (bP)

This mode permits the calibration tables for Bipolar Coag and Bipolar Cut to be adjusted to set output power to 50 ohms as close as possible to the displayed power in RUN mode.

Connect the output power tester to the Bipolar RF output jacks. If possible, set the tester for a 50 ohm load resistance, since this will yield the most accurate calibration results. If this resistance is not available, the Excalibur Plus PC™ may be calibrated using 100 or 125 ohm loads, however the accuracy will be degraded.

Connect the power plug to a source of AC power of the same frequency and within 5% of the voltage specified on the nameplate. Enter CAL Mode as described above.

Select "bP" in the CUT window, set load resistance Option in the COAG window to match the tester load resistance and select "A" or "P" option in the bipolar windows. Then press the "STORE" Key to enter the Bipolar Calibration Mode.

Coag will be selected by default. Target output current is displayed in amps to the nearest 10 mA in the Bipolar power window if "A" was selected. Target output power is displayed in watts to the nearest 1 watt in the CUT and COAG windows if "P" was selected. For target current, the decimal point is NOT displayed, but is effectively located at the left side of the two digit Bipolar power display. Thus a display of "99" should be read as "0.99" amps.

Using the general procedures described in Section 4.6.3 above, activate the unit in each of the points in both operational modes, making adjustments as required to set output to the displayed target as closely as possible.

When all points have been calibrated satisfactorily, pressing the "STORE" Key will store the updated values and restore the menu.

4.6.4 A.R.M. Calibration (PAD)

This mode calibrates the A.R.M. circuitry to Return Electrode resistances of 10 and 150 ohms. The only equipment required to complete A.R.M. Calibration are 10 and 150 ohm resistances accurate to 5% or better. Power ratings are unimportant, but wirewound resistors should not be used. A means to connect the resistance between both pins of either of the Return Electrode jacks is also required.

While at the menu level in CAL Mode, select PAD in the Cut window and press the "STORE" key. The Coag window will display the value in ohms of the resistance to be calibrated, and the ASSIST Resistance Indicator will be lit with a corresponding number of bars. A flashing ASSIST Resistance Indicator denotes an uncalibrated point.

Connect the selected resistance to the Return Electrode jack. Wait a second or two, then press the Alarm Set Point key to store the calibration value.



Use the Coag Power Increase or Decrease keys to select the other calibration point, connect the new indicated resistance, pause and press Alarm Set Point key.

If an error tone is sounded when the Alarm Set Point key is pressed, then the calibration point is out of range, and both points will be declared uncalibrated. Check to insure that the resistance has the value as displayed in the Coag window and that it is well connected to the Return Electrode. Then repeat calibration of both values.

Calibration was successful if the ASSIST Resistance Indicator is lit steadily for both points. Pressing the "STORE" key will restore the menu immediately and save the new values.

If calibration is incomplete or unsuccessful, pressing the "STORE" key will yield an Incomplete Cal error code, Err 10.9. Pressing the "STORE" key again will return the menu, and the PAd display will be flashing. If calibration was inadvertently incomplete, then the A.R.M. calibration mode may be reentered to correct the situation.

If a circuit fault is suspect, Diagnostics 2 should be entered for troubleshooting. Complete recalibration will be required after the circuit fault is corrected.

4.7 TROUBLESHOOTING

This section explains the troubleshooting aids built in to the Excalibur Plus PC™ and provides a guide to their use. Not all failures can be covered in a guide such as this, so the troubleshooter must by necessity understand the full operation of the unit. Read Section 3 for the description of system and circuit theory.

>WARNING<

READ THE SAFETY SUMMARY IN SECTION 1.1.4 BEFORE TROUBLESHOOTING THE UNIT.

If trouble is suspected, perform a thorough visual inspection, looking for loose or burned components which may point to the source of the problem. Verify that all connections are clean and seated properly and that soldered harness connectors are sound and not shorting. Check power

cord and all other wiring for evidence of mechanical damage. Check the regulated and unregulated power supply voltages. Improper supply voltages can produce a multitude of problems. Check that the RF shield is in place and all mechanical connections are secure. Check all fuses. Check the operating instructions and see if the suspected problem was actually designed to work that way.

4.7.1 Fault Codes

The Excalibur Plus PC™ microprocessor is programmed with a number of fault detection routines designed to shut the unit down safely if a failure has occurred. This shutdown procedure will produce a fault code that can help with the trouble shooting process. Refer to Appendix A for a complete list of the Fault Codes and their possible causes.

Two types of Fault codes can be generated by the unit. An "Err" fault code indicates a problem internal to the machine and generally requires a technician to fix the problem. Accessory problems, such as a stuck activation key, footswitch or control panel key are denoted by "ACC" fault codes. These codes can generally be cleared by turning the unit off, ensuring that no switches are pressed during power up, and turning the unit on. If this does not clear an ACC code, remove the accessory indicated and turn the unit on again. An ACC code not cleared by this will require repair.

Upon fault detection, the program displays a fault code in the Monopolar Cut and Coag power level displays. This loop takes /RFENA low, forces VBASE and the waveform generator output to zero drive condition and commands the relays to open. Further, it ceases generation of Watchdog Timer strobes and redundantly disables base and gate drive to the Power Amplifier.

If the Watchdog Timer detects a processor fault, it will issue an interrupt to the processor, causing a branch to the same routine as above if the processor is healthy enough to respond; if not, RF will still be disabled, but the front panel may not be capable of displaying the code. Additionally, if able, the unit will store the fault so it can be read later.



4.7.1.1 Checking and Clearing Last Fault Code

The Last Fault Code (LFC) that occurred during RUN mode can be viewed and also cleared if desired. It's good practice to clear the LFC so that recurring problems can be confirmed. To use LFC mode:

1. Enter CAL mode by pressing A3SW1 and turning unit on.
2. Press any key to end the display check more quickly. The unit will then go through self diagnostics and sound a two tone signal that it passed the diagnostics.
3. Press the Monopolar Cut Power adjust keys until "LFC" appears in the Cut power window.
4. Press "STORE". At that time, the display will show the last fault code or, if no Fault Code has occurred since the unit was last cleared, a series of dashes will appear on the display. Note the LFC for later reference.
5. TO KEEP THE LFC: press "STORE" to return to the top level.
6. TO CLEAR THE LFC: Press the "MONITOR SET" key. The display will then change to a series of dashes. Return to the top CAL menu by pressing STORE.

4.7.2 Pseudo Run Diagnostics (dIA 2)

Armed with a good understanding of the Theory of Operation in Section 3, one can make effective use of Pseudo Run Diagnostics (dIA 2) in correcting any of the faults which result in Err alarms in Run mode.

Pseudo Run Diagnostics (dIA 2) is provided to permit troubleshooting problems which cause the unit to lock up with a fault code in RUN mode. Such failures can be in the current limit circuitry, continuity detectors, or power amplifier, to name a few. These problems can be more effectively diagnosed if the unit is made operational.

In Pseudo Run Diagnostics (dIA 2), the unit operates as in normal RUN mode and will deliver

RF to the output jacks, except the following software routines which detect hardware faults are not executed:

- External NOVRAM validity.
- Program EPROM CRC validity.
- Calibration NOVRAM CRC validity.
- Watchdog Timer Lockout interrupt processing.
- Power Amp Overcurrent interrupt processing.
- Activation Switch Closure.
- Membrane Panel switch closure.
- A.R.M. circuit failure.
- Power settings in data memory does not match display.
- Relay test.

CAUTION: If any of those failures exist, the microprocessor may not shut the system down or display a fault code. One should be prudent in deciding whether or not to enter this mode without first attempting to identify the fault while powered down.

To start Pseudo Run:

1. Enter CAL mode. See Section 4.6.
2. Use the Cut Power adjust keys to select "dIA" in the Cut Power display.
3. Use the Coag Power adjust keys to select "2" in the Coag Power Display.
4. Press the Store key to activate mode. At that time, the unit will perform an abbreviated Self Diagnostics and then will operate normally except it will not perform the self checks listed above.

4.7.3 Watchdog Timer Troubleshooting (dIA 1)

This section contains help in troubleshooting the Watchdog Timer on the Controller PWB (A3).

A faulty Watchdog Timer (WDT) will cause the microprocessor to stop generating the /WDT signal in RUN mode. Troubleshooting this circuit is difficult without that signal, and setting up an external generator and connecting it to the circuit is time-consuming.



Watchdog Timer (dIA1) mode solves that problem by using the microprocessor as an on-board programmable pulse generator to allow selection of one of three pulse frequencies. One of the selections places pulses continuously inside the normal Watchdog Timer window, while the others are too early and too late. It is also possible to set RLYENA to verify operation of the lockup circuitry.

4.7.3.1 Accessing Watchdog Timer Diagnostics

Since this mode is useful only with the RLYENA flag in the reset state, "dIA" will not appear in the menu once RF has been activated in any of the power calibration modes. On the other hand, if a faulty WDT is detected on initial entry to CAL MODE, Watchdog Timer (dIA1) will be automatically entered, bypassing the menu, since proper calibration may be impossible if the WDT is faulty.

To enter Watchdog Timer (dIA1) voluntarily, enter CAL MODE per Section 4.6.1 above, then select "dIA" in the Cut window and "1" in the Coag window. Then press the "STORE" button. Entry will be signified by "1" appearing in the Bipolar Power window.

The menu cannot be restored from this mode. When work is complete, exit CAL Mode by using the RST switch or by powering down. This mode has no effect on the NOVRAM, so the calibration and CRC are unchanged.

4.7.3.2 dIA 1 Mode Selection

An indication of the currently selected mode appears in the Bipolar Power window. Modes are selected by using the Bipolar Power Adjust keys. Table 4.7 lists the available modes and the response for a normal unit.

4.7.3.3 Troubleshooting with Watchdog Timer (dIA1)

Since the WDT timing accuracy and ability to interrupt RF output are verified by the microprocessor on every power up, there is no need to recheck these parameters periodically. The only feature not checked automatically is lockout, which is extremely reliable due to its simplicity. If the unit declares an Err 4.X in RUN mode, then the timing is incorrect. For large timing errors, the Err Code may not correctly indicate the problem stage. In that case Watchdog Timer (dIA1) should be used. Select Late Mode 2 to observe timing of both WDT one-shot stages at their test points. Stage 1 should go high for 9 to

DISPLAY & MODE	/WDT PERIOD (msec)	WDTSTB2 First Stage (A3TP8)	/WDTINT Second Stage (A3TP2)
1 Normal	12.0	High for period of first one-shot. Nominally 10 msec.	High
2 Late	20.0	Same as Mode 1	High for period of second one-shot. Nominally 15 msec.
3 Early	2.0	High	Low
4 Lockup*	12.0	Same as Mode 1 until Mode 2 or 3 is selected. Then	High until Mode 2 or 3 is selected. Then latched to Low.

*RELYEN-Q (A3TP5) is Low until Mode 4 is entered. At that time, it is latched High.

Table 4.7 dIA 1 Modes



11 msec after each WDTSTB, and Stage 2 should run from 13.5 to 16.5 mS. WDTSTB is a very short pulse and may be difficult to see with an oscilloscope. Slight timing errors are most likely due to a faulty timing resistor or capacitor. Failure of the pulses to respond at all are more indicative of an IC failure.

An Err 7.0 indicates that the WDT did not shut down RF when Stage 2 timed out. This may be caused by failure of any of the components carrying the WDTFL signal to the WFG and VBASE circuits.

4.7.4 Base Voltage Generator Troubleshooting

Remove all base fuses on the A4 Power Conversion Assembly before checking a suspect Base Voltage Generator (BVG). Enter the dIA 2 mode (see section 4.7.2). Check that A3U20 is producing the proper VDAC voltage at A3TP14. Do this by selecting the Monopolar Blend 1 Cut mode, and increasing the power setting from 0 to 180W. Monitor TP14 to see that VDAC goes from approximately 9.95 Vdc at 0W to 2.5 Vdc at 180W when activated. The VDAC voltage at 180W will vary from unit to unit, the important factor is that the voltage changes in small increments.

Next monitor A3TP12 and repeat the above procedure. Confirm that TP12 voltage increases from no more than 0.4V at 0W to approximately 4.5 Vdc at 180W. If it fails to do so, check that VSENSE and ISENS are both less than 0.6V (this is true only if the base fuses have been removed).

Other problem sources could be one of the resistor divider chains in the BVG, a bad RFEN or WDTFL signal. Also check that the other components in the BVG chain are correct and functional.

If the BVG performs correctly as tested so far, and the Power Amplifier and Waveform Generator both test good, proceed with the following test. Turn off the unit and replace the fuses in the PA. Reenter dIA 2 and select Monopolar Blend. Monitor A3TP13 (VSENSE) and slowly increase the power setting on the front panel. When functioning correctly, TP13

will increase with power setting up to about 5.6 Vdc. At that point, there should only be a slight increase in TP13 voltage. If TP13 fails to increase towards 5.6 Vdc, do not proceed with this test; find the failed components and repair them.

After successful testing of the VSENSE circuit, connect a 300 ohm 250W load resistor to the unit's RF outputs. Select Monopolar Pure Cut and slowly increase the power setting while monitoring A3TP15. The dc voltage at TP15 should increase as power increases, but should not exceed 5.4 volts at full power.

Units that have passed the troubleshooting steps so far should be checked for properly oriented diodes, mismarked resistors, and correct divider voltages. If the unit has passed these BVG checks, then the problem is likely elsewhere.

4.7.5 Waveform Generator Troubleshooting

Enter the dIA 2 mode (see section 4.7.2). Check that a 20.0 MHz clock appears at A3TP32. Select a power setting and mode that corresponds to the photos in Fig. 3.5 and confirm the waveforms are similar to that at A4TP4 when activated (use A3TP20 to trigger the oscilloscope to get comparable results). If they are not, suspect one of A3U13-U18 as being bad. Another problem could be in the waveform select lines WV0-WV7.

4.7.6 Aspen Return Monitor (A.R.M.) Troubleshooting

The overall functionality of the A.R.M. circuitry may be checked per Section 4.5.7.

If these tests pass, but the unit still declares unaccountable Return Fault in operation with the ESU activated, interference from electrosurgical current is the likely cause. Check the A5T5 shield lid for good electrical and mechanical contact with the shield cup, and capacitors A5C44 and C45 for proper value and connection. Also check bypass capacitors A5C15, A3C25 and low pass filter capacitor A5C38.

If the ASSIST Resistance Indicator vs. resistance test fails, check BVARM at A3TP16 with 10 and 150 ohms connected to the Return Electrode



Jacks. With 10 ohms connected, BVARM should be +0.85 to 0.98 Vdc and with 150 ohms, it should be +1.89 to 2.18 Vdc. BVARM should also match VARM at A3TP17 to within 10 mV dc. If this test passes, then the trouble is most likely in the DAC A3U19 or A.R.M. comparator circuitry around A3U23. Note that a faulty DAC is also likely to cause Err 5.X Alarms.

If the VARM vs. resistance test fails, check the dc current source A3VR2 and A3U21D by connecting a dc milliammeter from A3TP17 to ground. The meter should read from 0.49 to 0.51 mA.

If VARM test reads near zero and the dc current is low, repeat the current test with A3J2 disconnected to eliminate a possible VARM short to ground in the A9W5 harness or on the A5 PWB and shorted transistors A5Q2 or Q3. With the Return Electrode Jacks open-circuited, check the waveforms on the A.R.M. oscillator collectors, A5Q2 and Q3. See Figure 3.7. They should appear as half-wave rectified sine waves with a frequency of 34.5 - 38.1 KHz. If the frequency is too high, A5C22, 23, 44 or 45 may be open. If the circuit is not oscillating and VARM is 0.6 - 0.8 Vdc, check the feedback resistors A5R7 and R8, transformer A5T4 for opens or shorts and transistors A5Q2 and Q3 for opens.

If the circuit is oscillating at the correct frequency but VARM does not respond to resistance changes, check the circuitry from the secondary to A5T4 to the Return Electrode jacks for shorts or open circuits.

4.7.7 RF Amplifier Troubleshooting

The first step in trouble shooting a Power Amplifier (PA) is to remove all PA collector and base fuses (check the fuses as you remove them and note if any of them are blown). This will prevent possible secondary failures in the PA due to overload.

Use a VOM to check for shorted bipolar power transistors (A4Q1-Q3, Q6-A8), power MOSFETS (Q4-Q5), and snubbing networks (A5D9-11, D14). Check to see that diodes (D1-3, D6-8) are functional. Check TP9 for approximately +110 Vdc and U2-6 for +12 Vdc.

Check the Base Voltage Generator and Waveform Generator for proper function before proceeding. If everything checks this far, enter dIA 2 (See section 4.7.2) and select Monopolar Pure Cut from the front panel. Confirm that A4TP10 and TP4 are approximately 0 to 10V signal swings, and the same shape as A3TP10.

Turn off the power to the unit and replace the base fuses. Reenter dIA 2 and select Monopolar Pure Cut from the front panel. Use an oscilloscope on the drains of A4Q4 and Q5 to confirm that the power MOSFETs are switching properly. Check the voltage on the cathode of D10 for approximately 39 Vdc.

If the unit has passed all tests to this point, it will be necessary to replace the collector fuses to troubleshoot further. Proceed with caution!

4.7.8. Power Amplifier Transistor Replacement

All bipolar power transistors A4Q1-Q3 and Q6-Q8 may be replaced singly without replacing the entire set. Calibration should be checked after transistor replacement. When replacing the power transistors:

1. Be sure to install the insulator pad. No thermal compound is necessary, but the mating surfaces of the transistor, insulator and heatsink should be clean. Replace any insulator which is torn, punctured or dirty.
2. Ensure that both pins of the transistor are properly centered in the socket before setting the transistor.
3. Tighten the screws to 4-6 inch-pounds. Excessive torque may cause the insulator pad to be cut, destroying its dielectric strength and shorting +110 Vdc to ground.

4.7.9 Troubleshooting Resets

Apparently random restarts of the unit are generally due to temporary loss of power. If the unit is the only machine in the room to restart, check for loose connectors in power supply circuits, broken or weakened power cords, and a disconnected or broken +5 volt regulator on the A3 assembly.



4.7.10 Interference with Other Equipment

Most, but not all equipment, for use in the operating room environment is designed to tolerate the interference created by electrosurgical generators. If other equipment does show interference, check that equipment for broken cable shields, faulty connectors, or open grounds. Video cameras are particularly prone to faulty cable shields since they are subject to flexing and sterilization procedures. The manufacturer of the equipment may be able to provide guidance in fixing the problem.

Improperly terminated video lines can also increase susceptibility to interference by loading the video signal level. As an example, when coaxial cable is used to route video signals to several locations, a 75 ohm terminator is sometimes used at each location, creating an extra load on the system. The other extreme is when no terminator is used. When long runs of coax are used to multiple loads, it may be best to use a video distribution amp to solve the load matching problem.

Interference problems can also be minimized by repositioning equipment, rerouting cables, power cords, or using a different power outlet.

4.8 PARTS ORDERING INFORMATION

To obtain replacement parts or additional information regarding your unit, write or telephone according to the contact information as listed on the inside front cover of this manual, or contact your CONMED distributor.

To ensure prompt service, please provide the following information:

- Model Number
- Serial Number
- Number Reference Designator and Description of Part
- Aspen Part Number (if known)
- Quantity Desired
- Mailing or Shipping Address
- Preferred Shipping Means (if any)
- Purchase Order Number (if applicable)
- Your Name

If you are returning a unit, obtain a Return Authorization (R.A) Number from CONMED Technical Services. Please mark the R.A. number on the outside of the carton for prompt service.

4.9 Parts Lists, PWB Layouts & Schematics

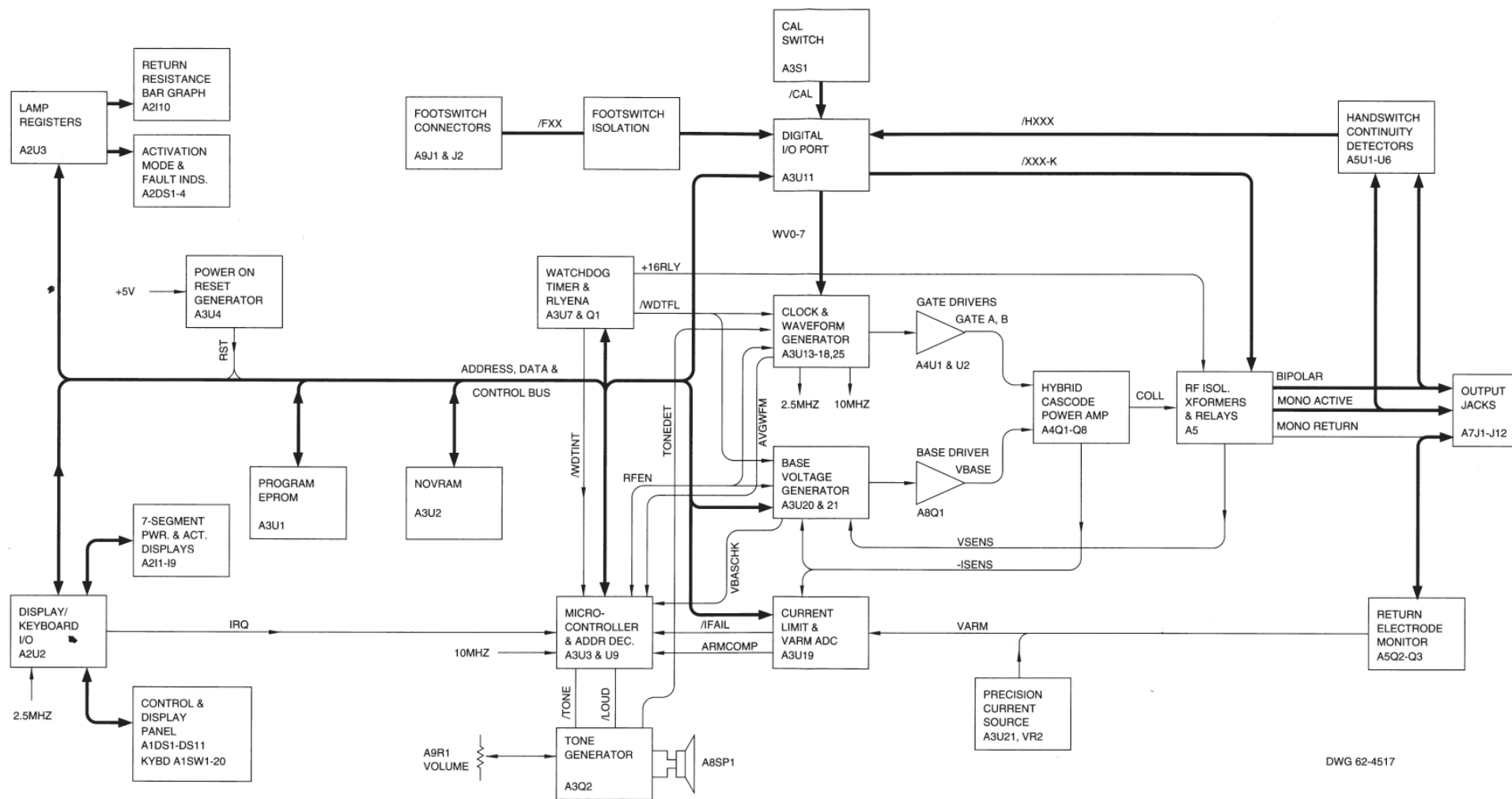
The following section contains printed wiring board layouts, parts lists and schematic diagrams.

The parts lists are shown on the same page as the corresponding schematic fold-out.

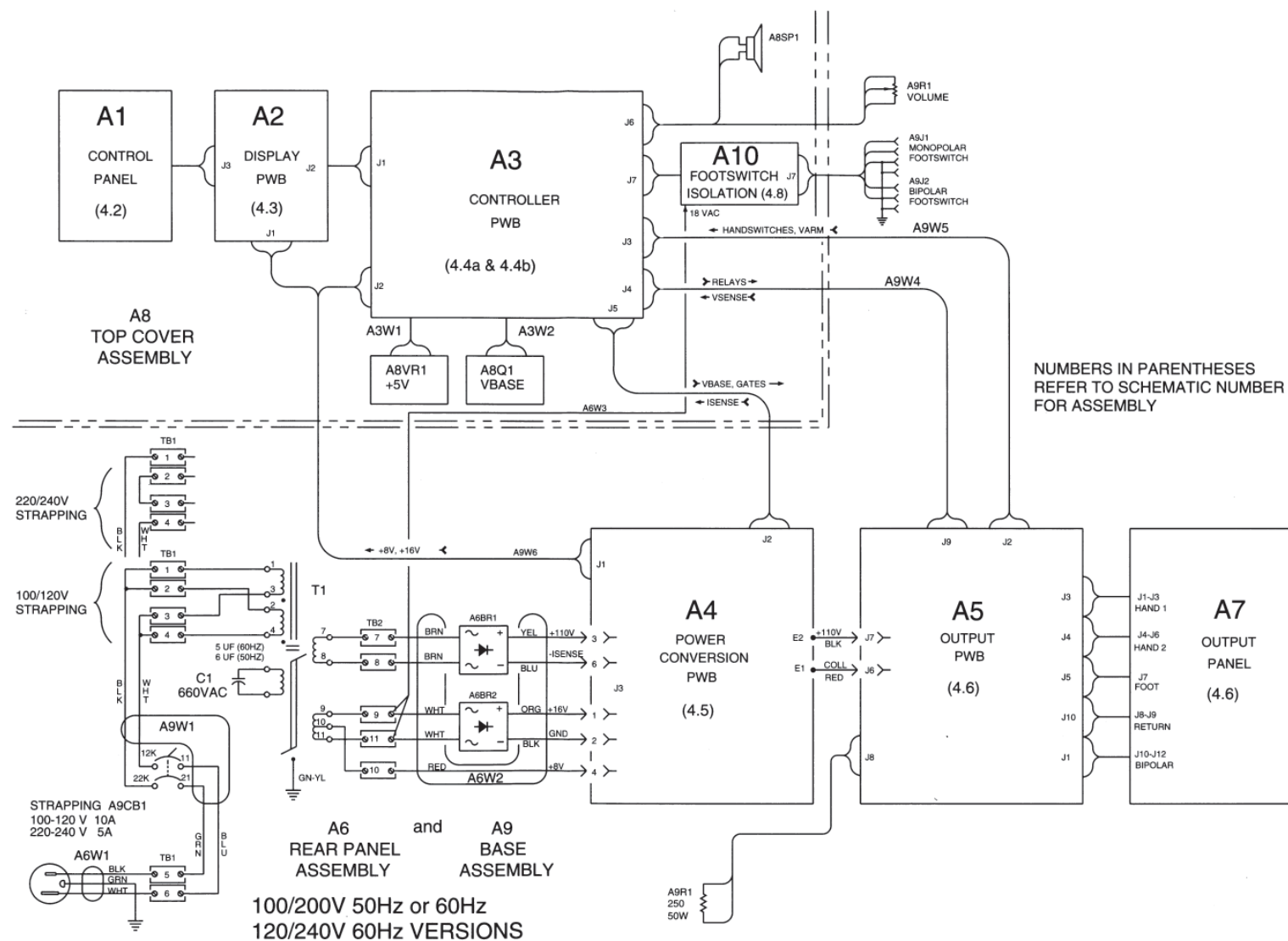
Listed are the replaceable parts available from CONMED. Many of the more common parts may be available from local electronic suppliers.



Schematic 4.0 Functional Block Diagram



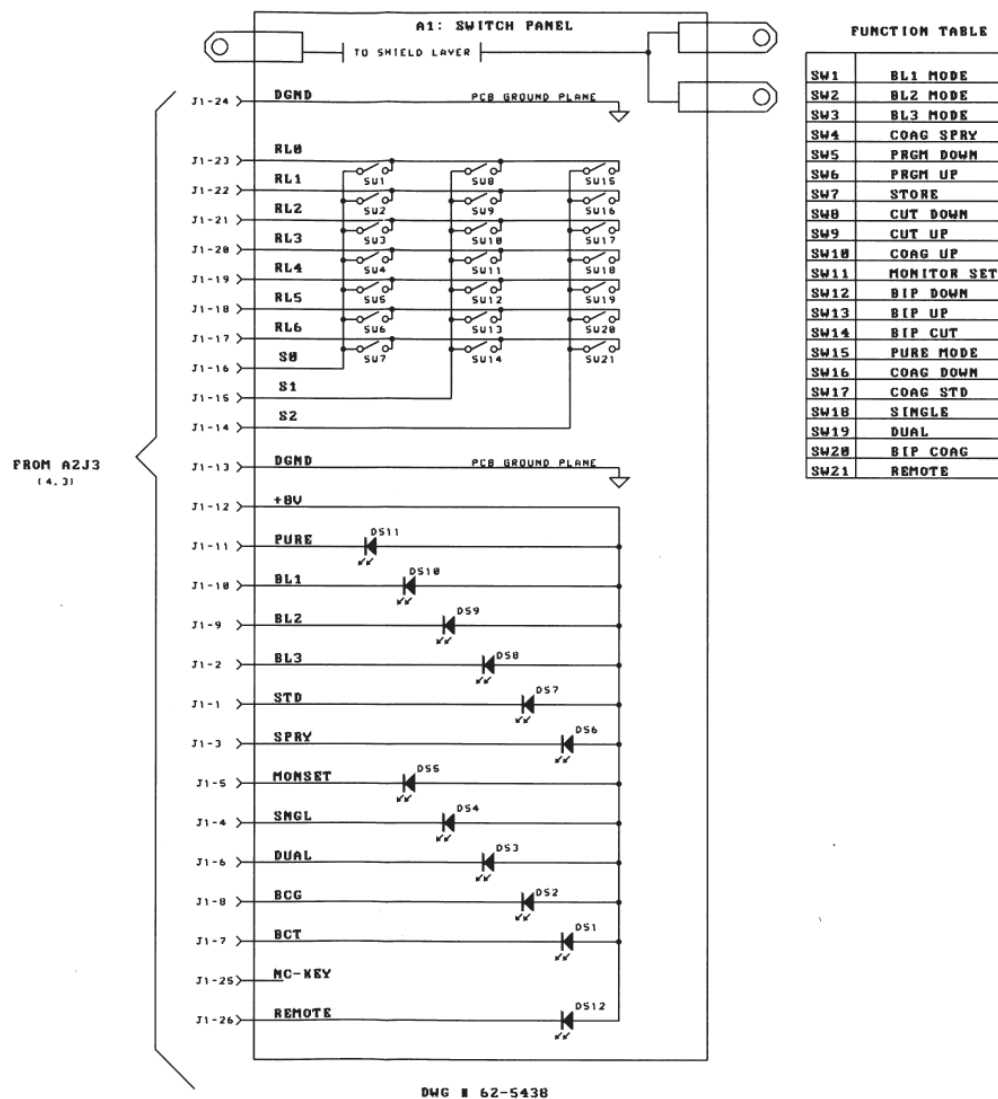
Schematic 4.1 Interconnect and Power Supply



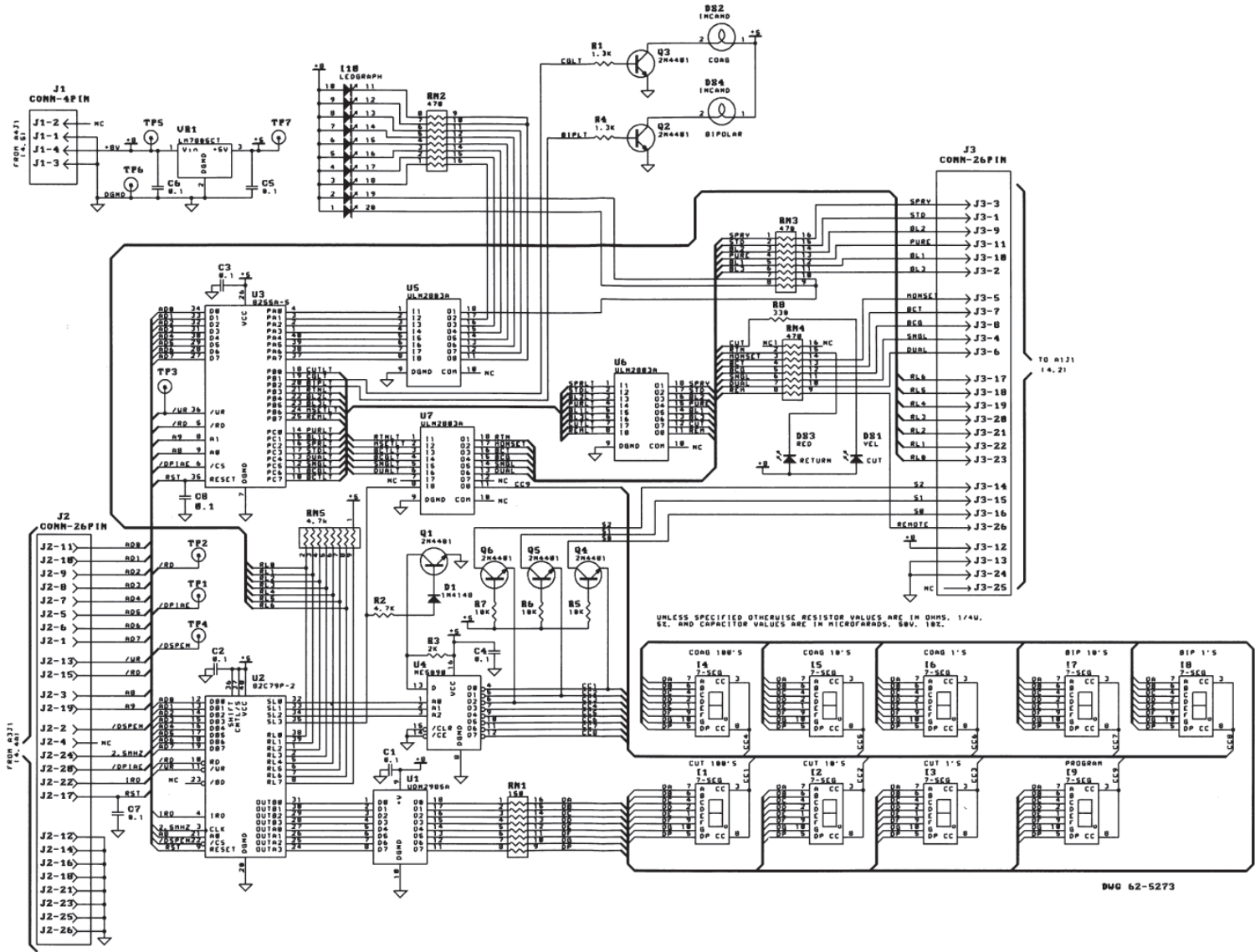
Ref. Des.	Aspen P/N	Description
ASSEMBLY: Rectifier Harness A6W2, 61-4191-001		
A4P3	62-4193-006	CONNECTOR HSG MOLEX 19-09-1069
A4P3	62-0076-002	TERMINAL MOLEX 02-09-1112
A6BR1,2	62-0288-005	TERMINAL SLIPON 1/4" #14-16
A6TB2	62-4168-005	TERMINAL BLOCK NYLON 5 POLE
N/A	62-0339-004	TUBING PVC-105-0
ASSEMBLY: Resistor Harness A9R2, 61-4185-001		
A4P8	62-3682-003	CONNECTOR HSG 3-PIN
A4P8	62-3682-201	CONNECTOR DISC. WIRE TERMINAL
A9R2	62-0362-004	RESISTOR WW 250 OHM 50W 3%
N/A	62-0620-004	TUBING 3/16
ASSEMBLY: Circuit Breaker Harness A9W1, 61-4187-001		
A6TB1	62-4168-006	TERMINAL BLOCK NYLON 5-POLE
A9CB1	62-0288-008	TERMINAL SLIPON 1/4" #18-22
N/A	62-0339-003	TUBING PVC-105-2
ASSEMBLY: A3/A4 Control Harness A9W2, 61-4188-001		
A3P5,A4P2	62-1389-012	PLUG .100 13 PIN
A3P5,A4P2	62-1388-001	TERMINALS CRIMP
N/A	62-0339-005	TUBING PVC-105-7/16
ASSEMBLY: Volume Control Harness A9W3, 61-4755-001		
A9R1	61-0448-002	POT, MOD, 500 OHM CW LOG TAPER
N/A	62-0431-001	WIRE, 22 AWG BUS
N/A	62-4427-007	WIRE, 24 AWG TWISTED ORG/WHT
N/A	62-0260-001	CABLE TIE, 3.5"
N/A	62-0339-001	TUBING, #2 PVC 105
N/A	62-4427-008	WIRE, 24 AWG TWISTED BRN/WHT
A3P6	62-1389-003	CONNECTOR, 4 PIN
N/A	62-1388-001	TERMINAL, CRIMP
ASSEMBLY: A3/A5 VSENSE/RELAY Harness A9W4, 61-4223-001		
ASP4,A3P4	62-1727-002	CONNECTOR IDC 14 PIN DIP
A9W4	62-1703-001	RIBBON CABLE 14-#28 47"
ASSEMBLY: A3/A5 Handcontrol/VARM Harness A9W5, 61-4223-002		
ASP2,A3P3	62-1727-003	CONNECTOR 16 PIN DIP
A9W5	62-1703-002	RIBBON CABLE 16-#28 31"
ASSEMBLY: A4 to A2/A3 Power Harness A9W6, 61-4190-001		
A2P1, A3P2	62-3682-004	CONNECTOR HSG 4-PIN
A4P1	62-3682-008	CONNECTOR HSG 8-PIN
A2P1,A3P2,	62-3682-201	CONNECTOR DISC. WIRE TERMINAL
A4P1		
N/A	62-0339-005	TUBING PVC-105-7/16
ASSEMBLY: Miscellaneous		
N/A	62-1763-001	ADHESIVE, TAK-PAK
N/A	62-3741-001	BRACKET HOOD RIGHT
N/A	62-3742-001	BRACKET HOOD LEFT
N/A	62-5294-001	CARTON, SHIPPING, EXCAL. PLUS
N/A	62-4231-001	CLAMP, CABLE
N/A	62-3739-007	COVER TOP
N/A	62-3734-001	GASKET SWITCH PNL
N/A	62-0324-004	GROMMET STRIP 1/32
N/A	61-5295-001	INSTAPACK EXCALIBUR RIGHT
N/A	61-5295-002	INSTAPACK EXCALIBUR LEFT
N/A	62-6257-001	INSTRUCTION CARD PACK
N/A	62-4233-001	LABEL RUN, RESET, CAL
N/A	62-0649-004	LOCKTITE #425
N/A	60-6270-001	MANUAL, OPERATOR
N/A	60-6280-001	MANUAL, SERVICE
N/A	62-0343-002	NUT #6-32 KEPS
N/A	62-0343-001	NUT #4-40 KEPS
N/A	62-4284-001	PIN 0.25D X 0.5L
N/A	62-1219-004	POLY BAG 24/36 IN
N/A	62-3402-001	RECEPTACLE 9 PIN
N/A	62-3894-003	SCREW 6-32 X 3/8 T HEAD PHILLIPS
N/A	62-4287-004	SCREW 8-32 X 1/2 BDGH PH
N/A	62-3894-002	SCREW 6-32 X 1/4 T HEAD PHILLIPS
N/A	62-3740-001	SHIELD, CONTROL

Ref. Des.	Aspen P/N	Description
N/A	62-0335-003	STANDOFF HEX 6-32 X 1 1/2
N/A	62-0260-002	TIE WRAP
N/A	60-5285-001	VIDEO TAPE, VHS, EXCALIBUR PLUS
N/A	62-0419-002	WASHER, FLAT #4
N/A	62-0419-003	WASHER, FLAT #6
ASSEMBLY: Rear Panel (A6) Not available as a completed assembly.		
N/A	62-1206-003	EQUIPOTENTIAL GND STUD
N/A	62-0419-002	FLATWASHER, #4
N/A	62-0620-004	HEATSHRINK TUBING, 3/16"
N/A	62-0418-002	LOCKWASHER, INT. TOOOTH, #4
N/A	62-0343-004	NUT KEPS #10-32
N/A	62-0343-002	NUT KEPS #6-32
N/A	62-0341-001	NUT, SMALL PATTERN, HEX, #4-40
N/A	62-4274-001	POWER CORD ASSEMBLY
N/A	62-3745-001	REAR PANEL
BR1,2	62-0257-001	RECTIFIER, BRIDGE 400V 25A
N/A	62-0799-007	SCREW #4-40 X 1/2" FH SLOTTED
N/A	62-0327-001	STRAIN RELIEF
N/A	62-0287-009	TERMINAL, 1/4" RING BLUE
N/A	62-0419-003	WASHER, FLAT #6
N/A	62-1752-001	WIRE BRAID
N/A	62-5349-001	HANDLE, REAR
N/A	62-5339-001	SCREW 1/4-20 X 1/2 FLT HD PH
ASSEMBLY: Base (A9) Not available as a completed assembly.		
N/A	62-4814-001	SCREW SELF-TAPPING TYPE F
N/A	62-0260-001	CABLE TIE
N/A	62-0272-001	THERMAL COMPOUND
N/A	62-0287-008	TERMINAL WIRE #10 RED
N/A	62-0337-002	FOOT PLASTIC
N/A	62-0339-005	TUBING PVC-105 X 7/16
N/A	62-0343-001	NUT KEPS #4-40
N/A	62-0343-002	NUT KEPS #6-32
N/A	62-0343-004	NUT KEPS #10-32
N/A	62-3608-004	SCREW #4-40 X 5/16 PH. PHILLIPS
N/A	62-3894-002	SCREW #6-32 X 1/4 T HEAD PHILLIPS
N/A	62-3894-004	SCREW #6-32 X 1/2 T HEAD PHILLIPS
N/A	62-3895-007	SCREW #6-32 X 1/2 FLH PHILLIPS
N/A	62-0418-005	WASHER LK #10
N/A	62-0419-005	WASHER FL #10
N/A	62-0645-005	CIRCUIT BREAKER 120V 10A
N/A	62-0645-004	CIRCUIT BREAKER 240V 5A
N/A	62-4172-003	SCREW 6-32 X 3/8 BTNHD CAP
N/A	62-1575-004	SCREW 6-32 X 3/8 SCH CAP
N/A	62-0306-001	KNOB
N/A	62-0309-001	CAP COLORED
N/A	62-4184-003	SCREW #10-32 X 3/8 SKT BTNHD CAP
N/A	62-2738-005	SCREW 6-32 X 1/2 TC TYPE F
N/A	62-2820-001	SPACER PWB
N/A	62-3746-001	HEAT SINK
N/A	62-3747-001	BASE, EXCALIBUR
N/A	62-4170-001	BRACKET CAP
N/A	62-4172-005	SCREW #6-32 X 5/8 SKT BTNHD CAP
N/A	62-0259-001	MOUNT, CABLE TIE
N/A	62-4184-005	SCREW 10-32 X 5/8 SKT BTNHD CAP
N/A	62-4279-001	HANDLE, FRONT, ESU
N/A	62-4280-001	CAM, HANDLE
N/A	62-4281-001	GROMMETS, ISOLATION
N/A	62-4184-006	SCREW 10-32 X 3/4 SKT BTNHD CAP
N/A	62-1753-001	GASKET RF
N/A	62-0287-002	TERMINAL, WIRE #6 RED
N/A	62-1754-001	TUBING, ZIPPER, 1/2" I.D.
N/A	62-1763-001	ADHESIVE, TAK-PAK
C1	62-4617-001	CAPACITOR, AC, 5uF
C1	62-4617-002	CAPACITOR, AC, 6uF
C1	62-4617-003	BOOT, CAPACITOR BUSHING, 60OC
TI	62-3725-001	TRANSFORMER FERRO 120/240V60Hz
TI	62-3725-003	TRANSFORMER FERRO 100/200V50Hz
TI	62-3725-004	TRANSFORMER FERRO 100/200V60Hz
TI	62-3725-005	TRANSFORMER FERRO 220/240/270V50Hz
TI	62-3725-006	TRANSFORMER FERRO 100/200V50-60Hz
N/A	62-5338-001	WASHER STEEL .300 OD
N/A	62-5338-002	WASHER STEEL .500 OD
N/A	62-3894-003	SCREW #6-32 X 3/8 T HD PH
N/A	62-5337-001	CLAMP CABLE HINGED

Schematic 4.2 Control Panel



Schematic 4.3 Display PWA

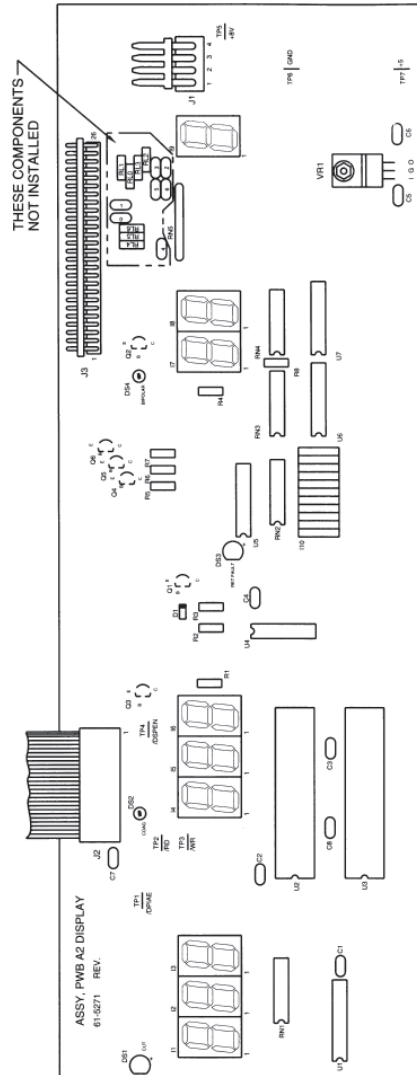


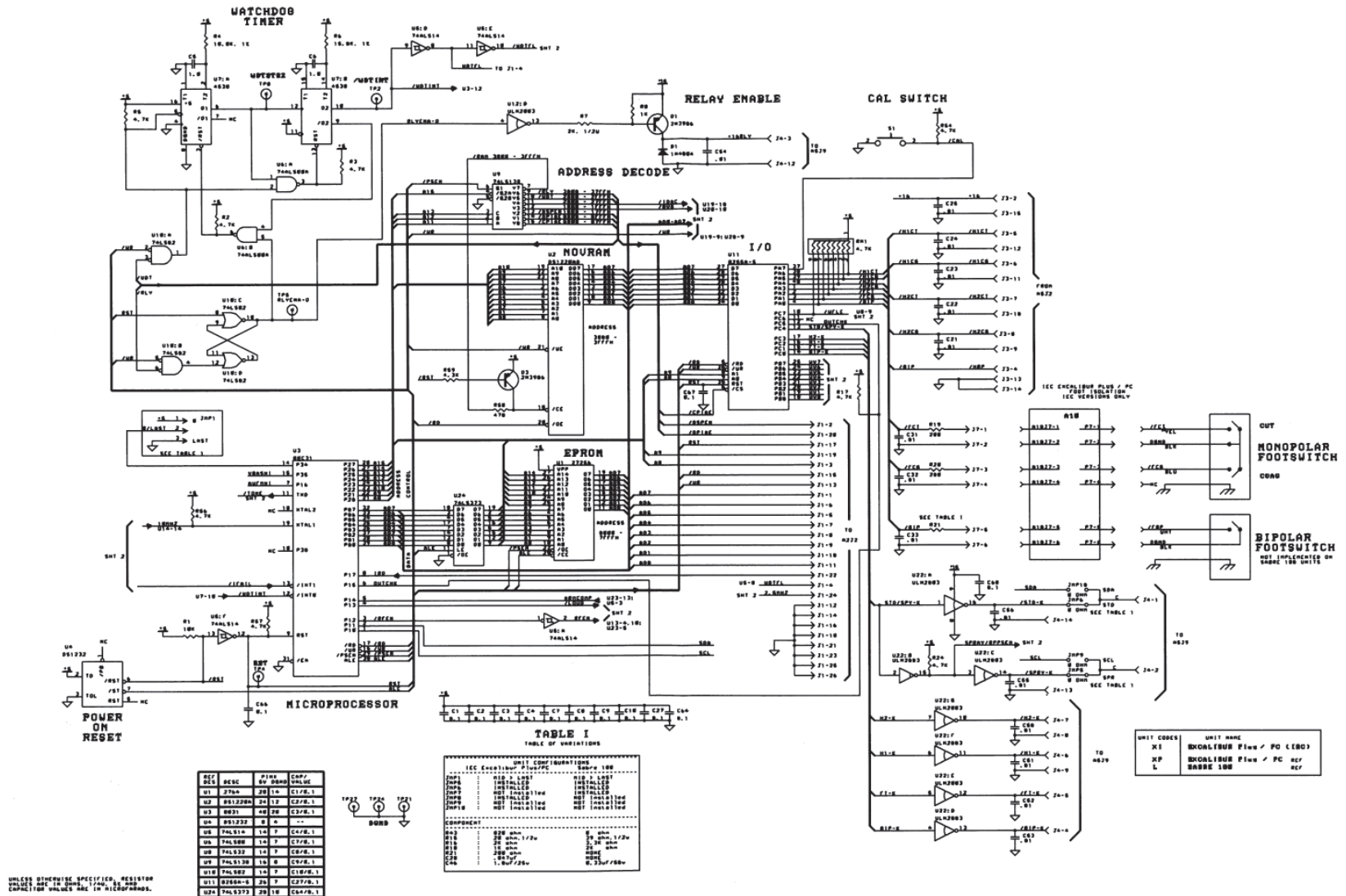
Ref. Des.	Aspen P/N	Description
-----------	-----------	-------------

ASSEMBLY: Display PWA (A2) 61-5271-001

C1-C8	62-0267-002	CAP, 0.1, 50V
D1	62-0289-001	DIODE, 1N4148
DS1	62-4056-003	LED, YEL
DS2,DS4	62-5288-001	LAMP, INCAND,T1
DS3	62-4056-001	LED, RED
I1 - I9	62-1361-003	HDSP - H153, LED, 7-SEG DISPLAY
I10	62-3462-001	LEDBAR, GRN
J1	62-3598-002	HEADER, FRICTION LOCK, 4-PIN
J2	62-1736-001	HARNESS, 26-PIN
J3	62-2860-005	HEADER, CONNECTOR RA, 26-PIN
Q1-Q6	62-4239-002	TRANSISTOR, NPN, 2N4401
R1,R4	62-0364-066	RESISTOR, 1.3K, 1/4W, 5%
R2	62-0364-079	RESISTOR, 4.7K, 1/4W, 5%
R3	62-0364-070	RESISTOR, 2K, 1/4W, 5%
R5-R7	62-0364-087	RESISTOR, 10K, 1/4W, 5%
R8	62-0364-063	RESISTOR, 1K, 1/4W, 5%
RN1	62-3463-001	RES. NET, 150, DIP 16, 2%
RN2-RN4	62-3463-007	RES. NET, 470, DIP 16, 2%
RN5	62-2861-001	RES. NET, 4.7K, SIP-9, 2%
U1	62-3459-001	IC, UDN2985A, DISPLAY DRIVER
U2	62-3458-001	IC, 82C79P2 KEYB./DISPLAY INT.
U3	62-3457-001	IC, 8255A-5, PIA
U4	62-4530-001	IC, NE5090N, ADDR. DISP DRIVER
U5, 6, 7	62-1374-003	IC, ULN2803A, 8 CH TRANSIST. ARR.
VR1	62-0417-004	VOLTAGE REG, LM7805CT +5, 2%
XDS1,XDS3	62-4919-001	MOUNT, LED
XDS2,XDS4	62-5289-001	SOCKET, LAMP
X11-110	62-2772-001	SOCKET STRIP, 10 PIN
N/A	62-3608-004	SCREW, #4-40, 5/16", P HEAD, PHILIPS
N/A	62-0343-001	NUT KEYS, 4-40
N/A	62-5272-001	PWB, DISPLAY, EXCALIBUR PLUS

Figure 4.4 A2 Display PWA





REF	DESC	QTY	MANUFACTURER	COMPONENT VALUE
U1	7744	20	14	C174.1
U2	8912240	20	17	C274.1
U3	8912240	40	20	C374.1
U4	891222	2	4	--
U5	74LS14	14	7	C474.1
U6	74LS00	14	7	C574.1
U7	74LS13	14	7	C674.1
U8	74LS138	14	8	C774.1
U9	74LS02	14	7	C874.1
U10	8255A-8	20	7	C974.1
U11	74LS237	20	10	C1074.1

TABLE I
TABLE OF VARIATIONS

COMPONENT	ICC EXECUTIVE / PC	UNIT CONFIGURATIONS
JMP1	IMP 1 LAST	IMP 1 LAST
JMP2	INSTALLED	INSTALLED
JMP3	NOT INSTALLED	INSTALLED
JMP4	NOT INSTALLED	NOT INSTALLED
JMP5	NOT INSTALLED	NOT INSTALLED
JMP6	NOT INSTALLED	NOT INSTALLED
JMP7	NOT INSTALLED	NOT INSTALLED
JMP8	NOT INSTALLED	NOT INSTALLED
JMP9	NOT INSTALLED	NOT INSTALLED
JMP10	NOT INSTALLED	NOT INSTALLED
JMP11	NOT INSTALLED	NOT INSTALLED
JMP12	NOT INSTALLED	NOT INSTALLED
JMP13	NOT INSTALLED	NOT INSTALLED
JMP14	NOT INSTALLED	NOT INSTALLED
JMP15	NOT INSTALLED	NOT INSTALLED
JMP16	NOT INSTALLED	NOT INSTALLED
JMP17	NOT INSTALLED	NOT INSTALLED
JMP18	NOT INSTALLED	NOT INSTALLED
JMP19	NOT INSTALLED	NOT INSTALLED
JMP20	NOT INSTALLED	NOT INSTALLED
JMP21	NOT INSTALLED	NOT INSTALLED
JMP22	NOT INSTALLED	NOT INSTALLED
JMP23	NOT INSTALLED	NOT INSTALLED
JMP24	NOT INSTALLED	NOT INSTALLED
JMP25	NOT INSTALLED	NOT INSTALLED
JMP26	NOT INSTALLED	NOT INSTALLED
JMP27	NOT INSTALLED	NOT INSTALLED
JMP28	NOT INSTALLED	NOT INSTALLED
JMP29	NOT INSTALLED	NOT INSTALLED
JMP30	NOT INSTALLED	NOT INSTALLED
JMP31	NOT INSTALLED	NOT INSTALLED
JMP32	NOT INSTALLED	NOT INSTALLED
JMP33	NOT INSTALLED	NOT INSTALLED
JMP34	NOT INSTALLED	NOT INSTALLED
JMP35	NOT INSTALLED	NOT INSTALLED
JMP36	NOT INSTALLED	NOT INSTALLED
JMP37	NOT INSTALLED	NOT INSTALLED
JMP38	NOT INSTALLED	NOT INSTALLED
JMP39	NOT INSTALLED	NOT INSTALLED
JMP40	NOT INSTALLED	NOT INSTALLED
JMP41	NOT INSTALLED	NOT INSTALLED
JMP42	NOT INSTALLED	NOT INSTALLED
JMP43	NOT INSTALLED	NOT INSTALLED
JMP44	NOT INSTALLED	NOT INSTALLED
JMP45	NOT INSTALLED	NOT INSTALLED
JMP46	NOT INSTALLED	NOT INSTALLED
JMP47	NOT INSTALLED	NOT INSTALLED
JMP48	NOT INSTALLED	NOT INSTALLED
JMP49	NOT INSTALLED	NOT INSTALLED
JMP50	NOT INSTALLED	NOT INSTALLED
JMP51	NOT INSTALLED	NOT INSTALLED
JMP52	NOT INSTALLED	NOT INSTALLED
JMP53	NOT INSTALLED	NOT INSTALLED
JMP54	NOT INSTALLED	NOT INSTALLED
JMP55	NOT INSTALLED	NOT INSTALLED
JMP56	NOT INSTALLED	NOT INSTALLED
JMP57	NOT INSTALLED	NOT INSTALLED
JMP58	NOT INSTALLED	NOT INSTALLED
JMP59	NOT INSTALLED	NOT INSTALLED
JMP60	NOT INSTALLED	NOT INSTALLED
JMP61	NOT INSTALLED	NOT INSTALLED
JMP62	NOT INSTALLED	NOT INSTALLED
JMP63	NOT INSTALLED	NOT INSTALLED
JMP64	NOT INSTALLED	NOT INSTALLED
JMP65	NOT INSTALLED	NOT INSTALLED
JMP66	NOT INSTALLED	NOT INSTALLED
JMP67	NOT INSTALLED	NOT INSTALLED
JMP68	NOT INSTALLED	NOT INSTALLED
JMP69	NOT INSTALLED	NOT INSTALLED
JMP70	NOT INSTALLED	NOT INSTALLED
JMP71	NOT INSTALLED	NOT INSTALLED
JMP72	NOT INSTALLED	NOT INSTALLED
JMP73	NOT INSTALLED	NOT INSTALLED
JMP74	NOT INSTALLED	NOT INSTALLED
JMP75	NOT INSTALLED	NOT INSTALLED
JMP76	NOT INSTALLED	NOT INSTALLED
JMP77	NOT INSTALLED	NOT INSTALLED
JMP78	NOT INSTALLED	NOT INSTALLED
JMP79	NOT INSTALLED	NOT INSTALLED
JMP80	NOT INSTALLED	NOT INSTALLED
JMP81	NOT INSTALLED	NOT INSTALLED
JMP82	NOT INSTALLED	NOT INSTALLED
JMP83	NOT INSTALLED	NOT INSTALLED
JMP84	NOT INSTALLED	NOT INSTALLED
JMP85	NOT INSTALLED	NOT INSTALLED
JMP86	NOT INSTALLED	NOT INSTALLED
JMP87	NOT INSTALLED	NOT INSTALLED
JMP88	NOT INSTALLED	NOT INSTALLED
JMP89	NOT INSTALLED	NOT INSTALLED
JMP90	NOT INSTALLED	NOT INSTALLED
JMP91	NOT INSTALLED	NOT INSTALLED
JMP92	NOT INSTALLED	NOT INSTALLED
JMP93	NOT INSTALLED	NOT INSTALLED
JMP94	NOT INSTALLED	NOT INSTALLED
JMP95	NOT INSTALLED	NOT INSTALLED
JMP96	NOT INSTALLED	NOT INSTALLED
JMP97	NOT INSTALLED	NOT INSTALLED
JMP98	NOT INSTALLED	NOT INSTALLED
JMP99	NOT INSTALLED	NOT INSTALLED
JMP100	NOT INSTALLED	NOT INSTALLED

UNLESS OTHERWISE SPECIFIED, RESISTOR VALUES ARE IN OHMS/RESISTOR CAPACITOR VALUES ARE IN MICROFARADS.



Ref. Des.	Aspen P/N	Description
ASSEMBLY: Controller PWA (A3) 61-5751-001		
A3W1	61-3461-001	HARNNESS ASSY EXCAL A3W1
A3W2	61-3461-002	HARNNESS ASSY EXCAL A3W2
U1	61-4265-017	IC PROG ROM IEC EXCAL + PC
U18	61-4266-002	IC WAVEFORM ROM 3 BLEND
U27	010561001	IC,FET DRIVER,7667
TP1,5,8,10,12-18,20-22,24,25	020361101	TEST POINT, BLK.
C59	62-0266-002	CAP CER 150PF 200V 10%
C18,19,21-26,29-33,41,50-56	62-0267-001	CAP DIP CER 0.01UF
C1-4,7-15,27,34,35,42,43,45,49,57,64-70,72,74	62-0267-002	CAP DIP CER 0.1UF
C38,39,47,48	62-0267-003	CAP DIP CER 33UF
C36	62-0267-004	CAP DIP CER 100PF
C73	62-0267-006	CAP CER, 1.0UF 50V
C71	62-0267-013	CAP CER, .15uF 50V
C17,20	62-0268-002	CAP ELEC 47UF 63V
D2-7,11,12	62-0289-001	DIODE 1N4148
R72	62-0364-015	RES, 10, 1/4W, 5%
R36	62-0364-039	RES, 100, 1/4W, 5%
R19-21	62-0364-046	RES, 200, 1/4W, 5%
R41	62-0364-053	RES, 390, 1/4W, 5%
R58	62-0364-055	RES, 470, 1/4W, 5%
R45	62-0364-056	RES, 510, 1/4W, 5%
R43	62-0364-061	RES, 820, 1/4W, 5%
R8,22,48	62-0364-063	RES, 1000, 1/4W, 5%
R16,31	62-0364-070	RES, 2000, 1/4W, 5%
R25	62-0364-072	RES, 2400, 1/4W, 5%
R12,13	62-0364-075	RES, 3300, 1/4W, 5%
R59	62-0364-078	RES, 4300, 1/4W, 5%
R2,3,5,17,24,33,54,56,57,67,71	62-0364-079	RES, 4700, 1/4W, 5%
R42,44	62-0364-081	RES, 5600, 1/4W, 5%
R1,40,46,50,55	62-0364-087	RES, 10K, 1/4W, 5%
R68	62-0364-100	RES 36K 1/4 5%
R51	62-0364-105	RES, 56K, 1/4W, 5%
R69	62-0364-111	RES, 100K, 1/4W, 5%
R52,53,70	62-0364-135	RES, 1.0M, 1/4W, 5%
R15	62-0365-022	RES CF 39 1/2 W 5%
R14	62-0365-060	RES, 750, 1/2W, 5%
R18	62-0365-063	RES, 1000, 1/2W, 5%
R7	62-0365-070	RES, 2000, 1/2W, 5%
C28,37	62-0451-001	CAP CER 0.047UF 100V 20%
D1,9	62-0565-001	DIODE
R62	62-0961-213	RES, 1.62K, 1/4W, 1%
R47	62-0961-231	RES, ME1.249K, 1/4W, 1%
R61	62-0961-252	RES, 4.12K, 1/4W, 1%
R60,63	62-0961-260	RES, 4.99K, 1/4W, 1%
R4,37,38	62-0961-289	RES, ME 10.0K, 1/4W, 1%
R27,29	62-0961-300	RES, ME 13.0K, 1/4W, 1%
R6,R64	62-0961-306	RES, ME 15.0K, 1/4W, 1%
R49	62-0961-309	RES, ME16.2K, 1/4W, 1%
R9-11,39	62-0961-318	RES, ME 20.0K, 1/4W, 1%
R34	62-0961-326	RES, ME 24.3K, 1/4W, 1%
R32	62-0961-333	RES, ME28.7K, 1/4W, 1%
R35,65	62-0961-340	RES, ME 34.0K, 1/4W, 1%
R66	62-0961-354	RES, 47.5K, 1/4W, 1%
R26	62-0961-361	RES, ME 56.2K, 1/4W, 1%
R23	62-0961-378	RES, ME 84.5K, 1/4W, 1%
R28,30	62-0961-414	RES, ME200K, 1/4W, 1%
VR2	62-0964-001	DIODE
C16,44,46	62-1357-001	CAP TANT IUF 25V 10%
U7	62-1370-001	IC DUAL ONE-SHOT 4538
U12,22	62-1374-001	IC XSTR ARRAY ULN2003
J4	62-1377-002	SOCKET
J3	62-1377-003	SOCKET
X1,18	62-1377-008	SOCKET DIP 28 PIN
J6	62-1390-003	RECEPTACLE
J7	62-1390-005	RECEPTACLE
J5	62-1390-012	RECEPTACLE
U14-16	62-1711-001	IC 4BIT BIN 74LS163
U9	62-1714-001	IC OCTAL DECODER 74LS138
U10	62-1715-001	IC QUAD 2NOR 74LS02
Y1	62-1718-002	CLOCK OSCILLATOR 20 MHZ
VR1	62-1719-002	REGULATOR VOLT T092 12V
C40	62-1854-001	CAP TANT 10UF 16V 10%
U3	62-2569-002	IC,MICROCNTL,8 BIT,80C31
C5,6,61	62-2844-001	CAP,1.0UF 63V

Ref. Des.	Aspen P/N	Description
JMP1	62-2860-002	HEADER, RT ANGLE, 6 PIN
RN1	62-2861-001	RES, NETWORK, 9 PIN
JMP5,6,8	62-3062-001	RES,ZERO OHM
U21	62-3394-001	IC OP AMP QUAD
U11	62-3457-001	IC PIA 8255A-5
Q1,2,3	62-3464-001	TRANSISTOR PNP 2N3906
U2	62-3466-003	IC NOVDRAM EXCAL +
J2	62-3598-002	HEADER FRCT LOK 34CKCT RT
VR3	62-3957-001	IC,VOLT REE 2.5V 1%,TO-92
U13	62-4253-001	IC 4INPUT NAND 74LS140
U17	62-4254-001	IC SHFT REG 8 BIT 74LS166
U19,20	62-4255-001	IC D-A CONVERT AD558
U23,26	62-4257-001	IC QUAD COMPARTOR LM339
U4	62-4258-001	IC MICROMONITOR DS1232
U24,25	62-4597-001	IC, FLIP-FLOP 74LS373
S1	62-4855-002	SWITCH SPST, N.O.
J1	62-4929-001	HEADER, RT ANGLE, 80 CONTACT
JMP1	62-4931-001	JUMPER, .025"X.100", 2 PIN
U6	62-5853-000	I.C. 2 INPUT NAND, 74ALS00A
U5	62-5853-014	I.C. HEX INV 74ALS14
U8	62-5853-032	I.C. 2 INPUT OR 74ALS32

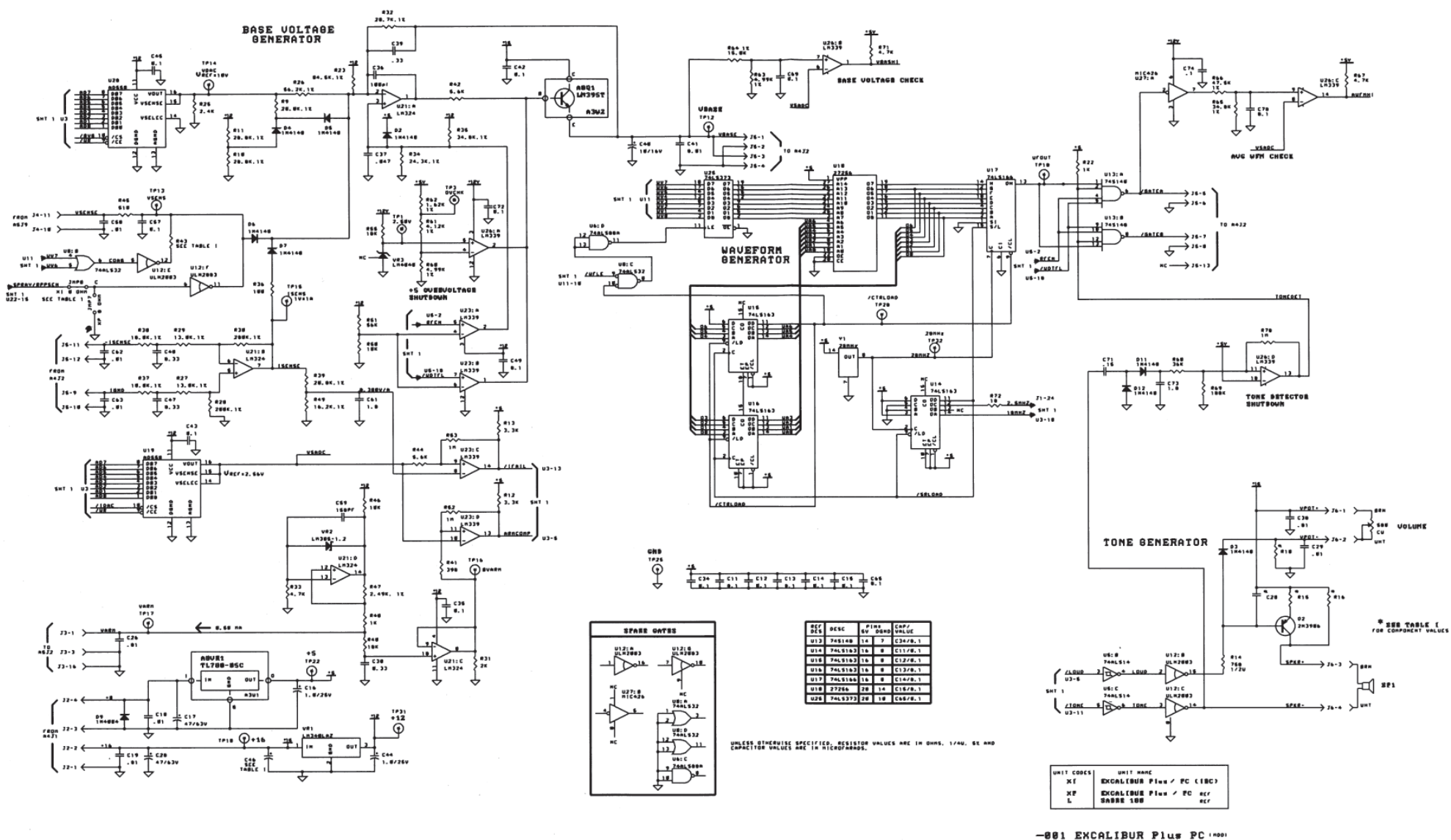
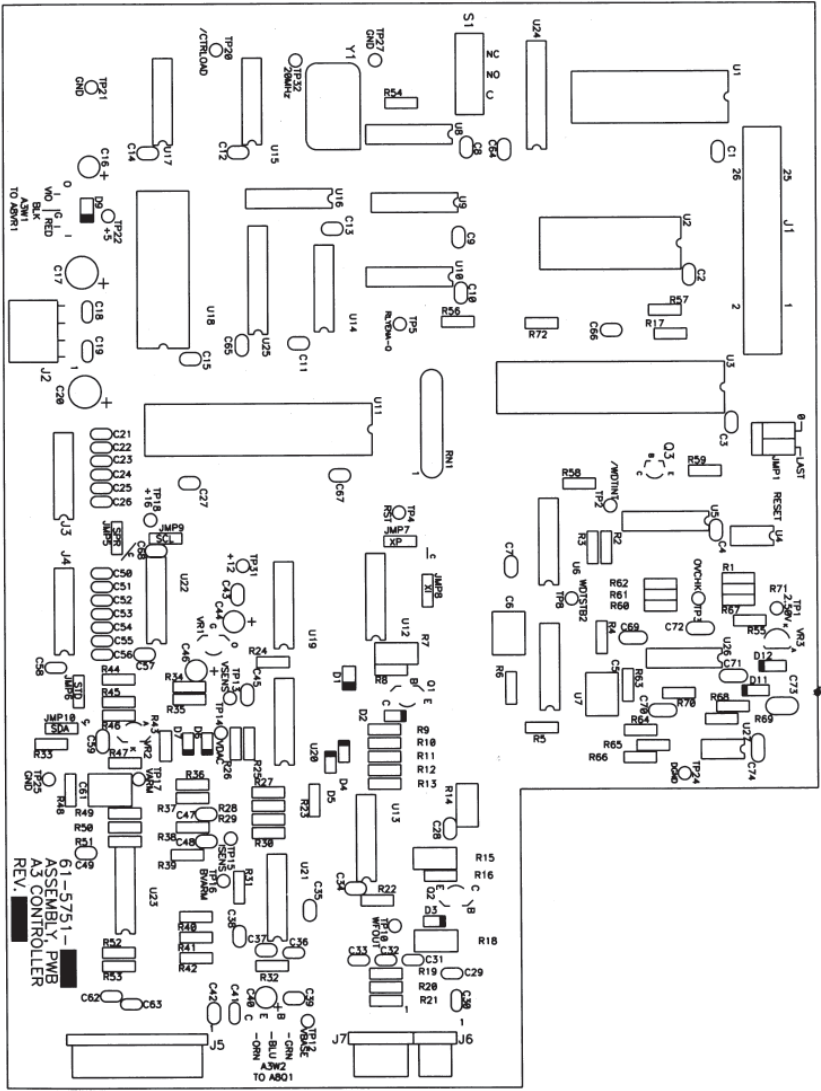


Figure 4.5: A3 Controller PWA

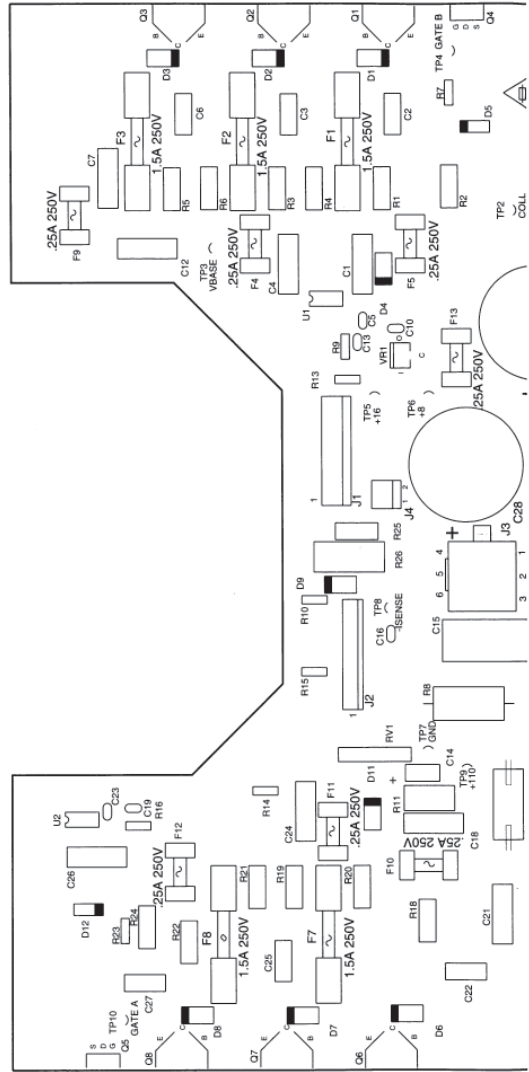


Ref. Des.	Aspen P/N	Description
-----------	-----------	-------------

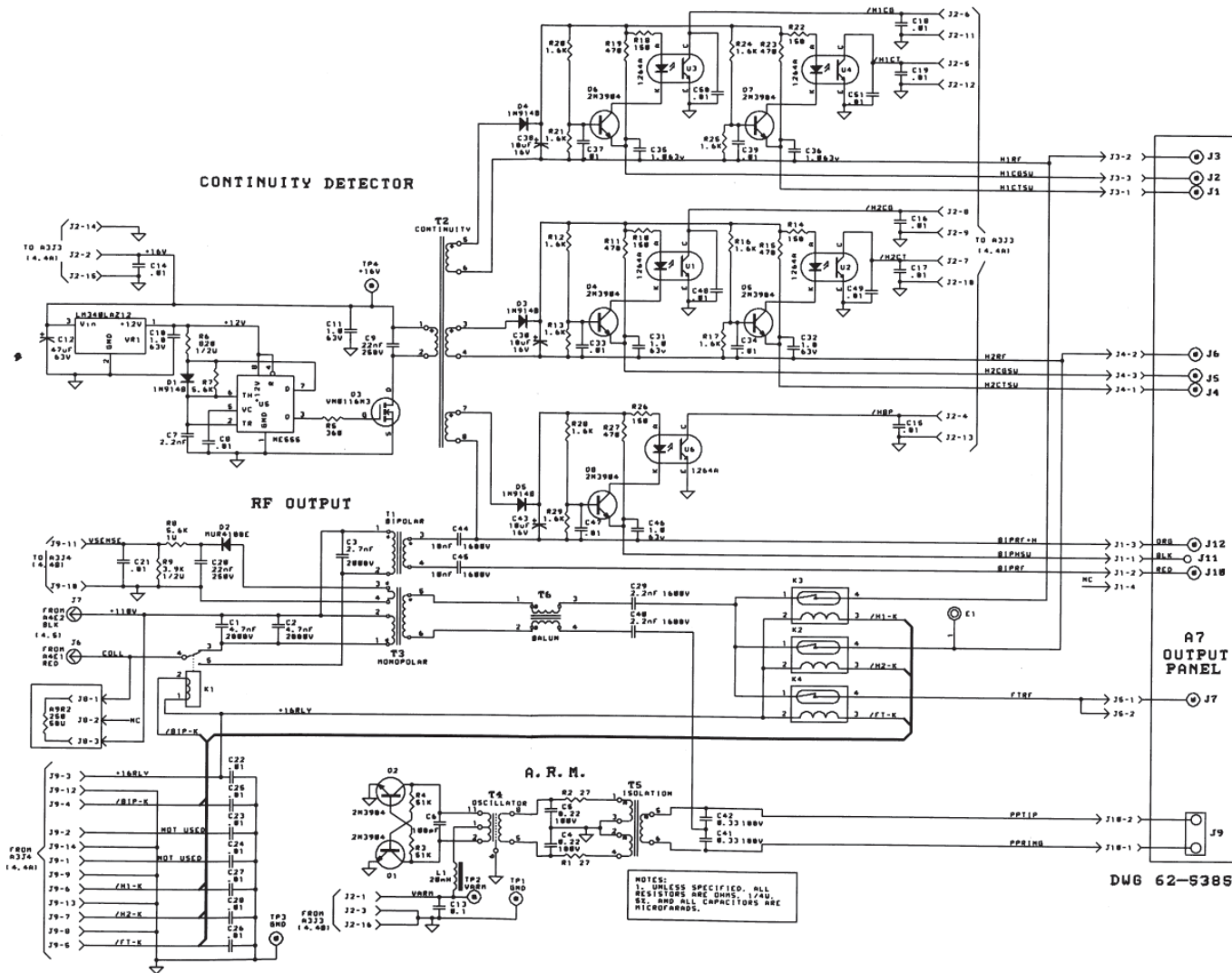
ASSEMBLY: Power Conversion PWA (A4), 61-4120-001

R7,23	62-0364-016	RESISTOR 11 1/4W 5% CF
R10,15	62-0364-050	RESISTOR 300 1/4W 5% CF
R9,16,27,28	62-0364-063	RESISTOR 1K 1/4W 5% CF
R13,14	62-0364-066	RESISTOR 1.3K 1/4W 5% CF
R25	62-0365-105	RESISTOR 56K, 1/2W 5% CC
R11	62-0367-039	RESISTOR 100 2W 5% CF
R8	62-4243-001	RESISTOR 0.1 5W 5% WW
R2,4,6,20, R21,24	62-1693-003	RESISTOR 0.62 2W 5% WW
R1,3,5,18, R19,22	62-1693-002	RESISTOR 3.3 2W 5% WW
R12	62-0363-007	RESISTOR 4K 8W 5% WW
R26	62-4243-004	RES. CERAMIC FLAMEPROOF 120, 5W 5%
C11,20	62-3314-003	CAP ELEC 820 200V
C8	62-3314-004	CAP ELEC 22000 25V
C9	62-3314-005	CAP ELEC 27000 16V
C9	62-3314-006	CAP ELEC 33000 16V
C14	62-2720-005	CAP ELEC 22 25V
C15	62-1679-001	CAPACITOR PP 1.0 200V
C1,4,7, C12,18,21, C24,26	62-1680-001	CAPACITOR PC 1.0 63V
C2,3,6,22	62-1681-001	CAPACITOR PE .01 100V
C25,27		
C10,16	62-0267-002	CAPACITOR CER 0.1 50V
C5,23	62-0267-003	CAPACITOR CER 0.33 50V
D9	62-1684-001	DIODE ZENER 39V 1N6285
D5,12	62-1687-001	DIODE ZENER 18V 1N5355A
D4,11	62-4865-001	DIODE, 1N5401
D1-3,6-8	62-1683-001	DIODE, HIGH VOLTAGE/SPEED
VR1	62-0417-005	REGULATOR, VOLTAGE +12V LM340AT
DS1	62-4056-001	LED, RED
RV1	62-4594-004	VARIATOR 17V
U1,2	62-1709-001	IC DUAL CLOCK DRIVER 0026
J2	62-2845-012	RECEPTACLE STRAIGHT 13 PIN
J1,4	62-3598-001	HEADER .156" (8P1) (2E; J4 -002)
J3	62-4248-006	HEADER .093" 6 PIN
XF1-3,6-8	62-0295-001	FUSE CLIP, 3AG
XF4,5,9, XF10-13	62-0295-003	FUSE CLIP, 2AG (XF13 -002 ONLY)
TP1-11	62-2725-001	TEST POINT .200"
N/A	62-4244-001	WIRE, 14 AWG, RED
N/A	62-4244-002	WIRE, 14 AWG, BLACK
E1,2	62-4247-001	CONNECTOR EASTON INSUL 0.250
A4	61-5246-001	ASSY. A4 PWR CONVERSION PWB
A4	61-5246-002	ASSY. A4 PWR CONVERSION PWB
Q1-3, Q6-8	62-4773-004	TRANSISTOR, NPN, MJW16018
Q4,5	62-4242-001	TRANSISTOR, FET BUZ 71
N/A	62-3429-003	INSULATOR PADS TO-247
N/A	62-3429-002	INSULATOR PADS TO-220
N/A	62-4768-001	BRACKET MOUNT
N/A	62-1575-004	SCREW, SOCKET HEAD, 6-32 X 3/8"
N/A	62-4878-007	SCREW, SOCKET HEAD, #4-40 X 1/2"
N/A	62-4901-001	WASHER, COMPRESSION #4
XQ4,5	62-4286-001	CLAMP TO-220
F1-3, 6-8	62-1596-001	FUSE, 1.5A, 250V, 3AG
F4,5,9,10	62-4866-003	FUSE, 0.25A, 2AG
F11-12		
N/A	62-5297-001	HEATSINK, EXCALIBUR
N/A	62-0649-002	LOCKTITE, TYPE 222
N/A	62-0419-003	WASHER, FLAT, #6
N/A	62-4878-002	SCREW, SOCKET HEAD, #6 X 3/16"

Figure 4.6 A4 Power Conversion PW.

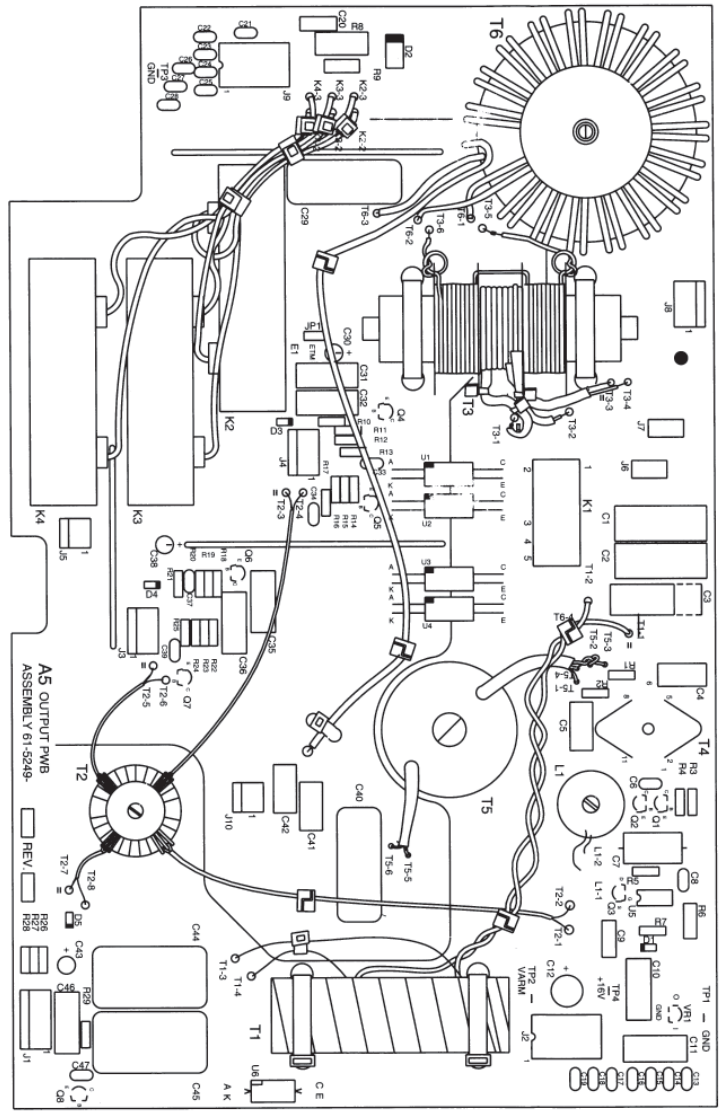


Schematic 4.6 Output

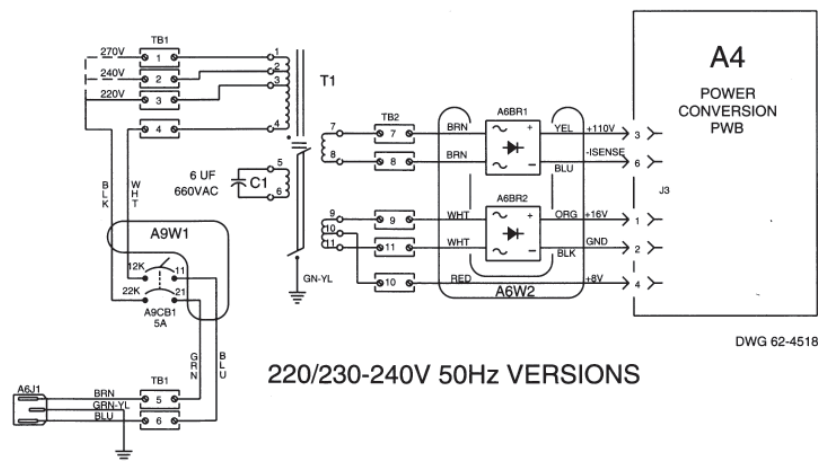
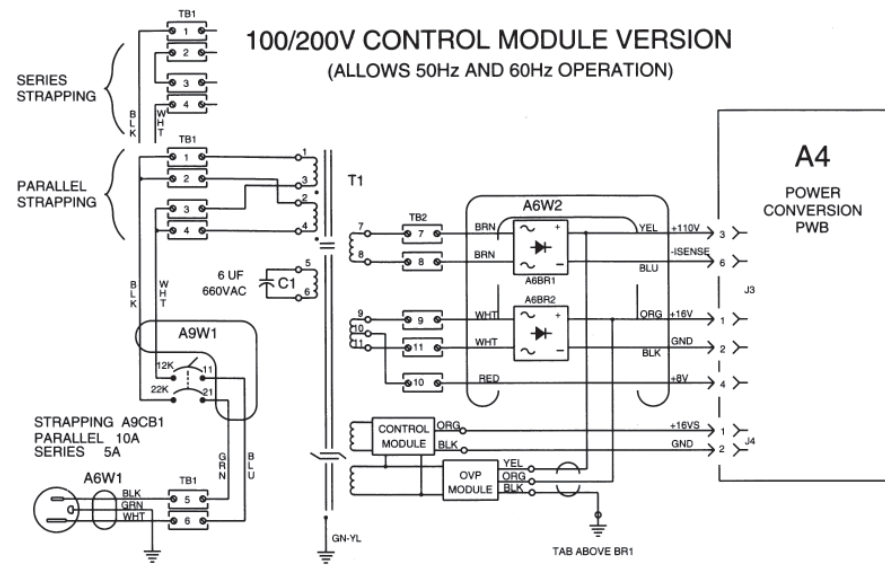


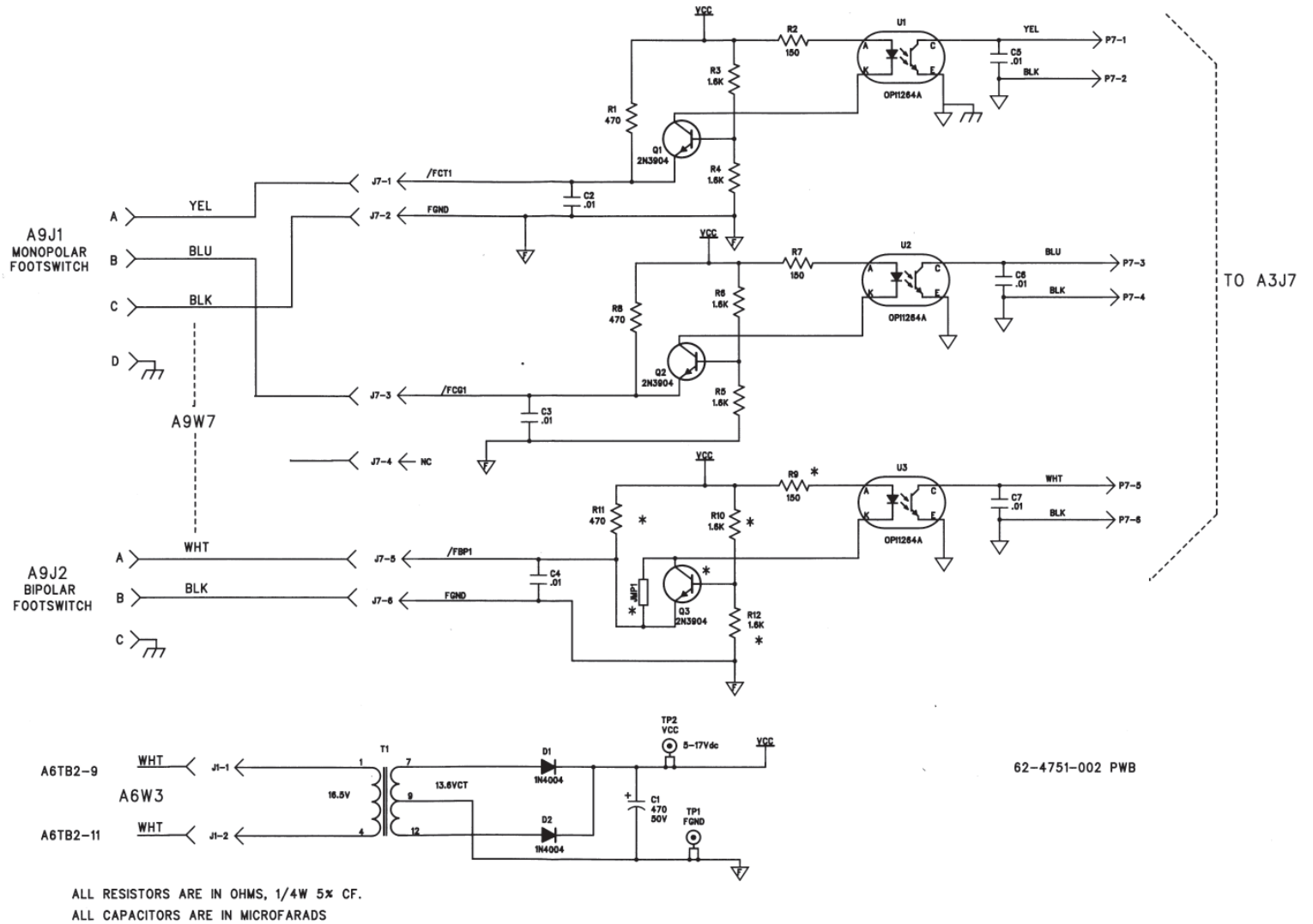
Ref. Des.	Aspen P/N	Description
R3, 4	62-0364-104	RESISTOR, 5.1K, 1/4W, 5%
R7	62-0364-081	RESISTOR, 5.6K, 1/4W, 5%
R12,13,16, R17,20,21, R24,25,28, R29	62-0364-068	RESISTOR, 1.6K, 1/4W, 5%
R11,15,19, R23,27	62-0364-055	RESISTOR, 470, 1/4W, 5%
R5	62-0364-052	RESISTOR, 360, 1/4W, 5%
R10,14,18, R22,26	62-0364-043	RESISTOR, 150, 1/4W, 5%
R1,2	62-0364-025	RESISTOR, 27, 1/4W, 5%
R9	62-0365-077	RESISTOR, 3.9K, 1/2W, 5%
R6	62-0365-061	RESISTOR, 820, 1/2W, 5%
R8	62-0366-081	RES, 5.6K, 1W, 5%
C10,11,31, C32,35,36, C46	62-1356-001	CAP, PC, 1.0uF, 63V, 5%
C41,42	62-1677-004	CAPMET PE, 0.33uF, 100V, 5%
C4,5	62-1677-005	CAPMET PE, 0.22uF, 100V, 5%
C13	62-0267-002	CAP, CER, 0.1uF, 50V, 20%
C9,20	62-1677-001	CAPMET PE, 22NE, 250V, 10%
C44,45	62-1676-002	CAP, PE, 10uF, 1600V, 5%
C12	62-0268-002	CAP, ELEC, 47uF, 63V, 20%
C8,14,19,21, C22,28,33, C34,37,39, C47	62-0267-001	CAP, CER, 0.01uF, 50V, 20%
C3	62-1675-003	CAPMET PE, 2.7NE, 2000V, 5%
CL2	01-0261-472	CAPMET PE, 4.7NE, 2000V, 5%
C7	62-0263-005	CAP, PS, 2.2uF, 100V, 5%
C30,38,43	62-0268-001	CAP, 10uF, 16V, 20%
C29,40	62-1676-001	CAP, PE, 2.2NE, 1600V, 5%
C6	62-0267-004	CAP, CER, 100uF, 50V, 10%
U5	62-0301-001	L.C. TIMER 555
K1	62-0638-003	RELAY, SPST, 12V
Q1,2,4,8	62-4239-001	NPN TRANSISTOR, 2N3904
Q3	62-4853-001	TRANSISTOR, FET, VN0116N3
D1, 3,5	62-0290-002	DIODE, 1N914B
D2	62-1683-001	DIODE, HV, FAST RECOVERY
U1-4,6	62-4238-001	OPTOISOLATOR, OPTI1264A
T1	61-4175-003	XFORMER, BIPOLAR, IEC EXCALIBUR +
T5	61-4176-006	XFORMER, ARM/ISO, IEC EXCALIBUR +
T3	61-5393-001	XFORMER, MONO, IEC EXCALIBUR +
T4	62-4177-001	XFORMER, ARM OSCIL, EXCALIBUR
T2	61-4179-005	XFORMER, CONT DET, IEC EXCALIBUR +
T6	61-5392-001	XFORMER, BALUN, IEC EXCALIBUR +
K2-4	62-3473-003	RELAY, REED, HV, 14V, FLYING LEADS
VR1	62-1719-002	REGULATOR, VOLTAGE, TO92, 12V, 3%
J9	62-1377-002	SOCKET/DIP, 14PIN
J2	62-1377-003	SOCKET/DIP, 16PIN
J10	62-3598-003	HEADER, FRICTION LOCK
J6, 7	62-0286-002	HEADER, 24 PIN GOLD FRICTION LOCK
TP1-4	62-2725-001	TEST POINT
N/A	62-0260-001	CABLE TIE, .085W
N/A	62-0260-002	CABLE TIE, .190W
N/A	62-4240-001	NYLON WIRE STANDOFF, 1"
(L1)	62-0753-003	NUT, HEX, NYLON, #6-32
(L1)	62-4278-001	SCREW, NYLON, #6-32 X 1/2 BH
A5	62-5248-001	PWB, A5 OUTPUT, IEC EXCALIBUR PLUS
(T6)	62-5647-001	SPACER, 5/8" ROUND, NYLON
(T6)	62-5646-001	WASHER, NYLON (1-1/2" O.D.)
(T6)	62-0343-004	KEP NUT, #10
(T6)	62-0419-005	WASHER, FLAT, #10
(T6)	62-5648-001	SCREW, #10-32 PAN HD (2-1/2" LG)
(T2)	62-4278-005	SCREW, NYLON #6-32 X 3/4"
(I2)	62-5234-001	BUSHING, SHLDR, RUBBER
(T2)	62-0753-003	NUT, NYLON, #6-32
L1	62-4178-001	CHOCHE, 20MH
JP1	62-3062-001	JUMPER, ZERO OHM RES
N/A	62-0274-001	RTV SEALANT - GRAY
N/A	62-0274-002	RTV SEALANT - CLEAR
N/A	62-0620-009	HEATSHRINKABLE TUBING, 3/8", CLEAR

Figure 4.7 A5 Output PWA



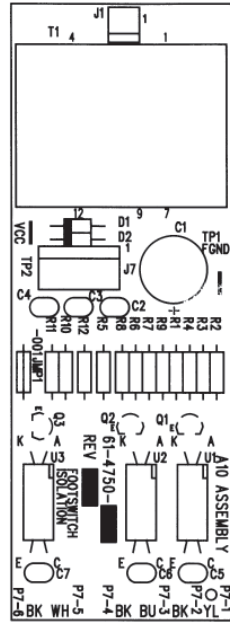
Schematic 4.7 Mains Voltage and Frequency Variations





Ref. Des.	Aspen P/N	Description
ASSEMBLY: Footswitch Isolation PWA (A10), 61-4750-002		
T1	62-4749-001	XFMR PWR 2.5VA 50/60 HZ
C2-C7	62-0267-001	CAP DIP CER 0.01UF
C1	62-0268-005	CAP ELEC 470UF 50V
R2,R7,R9	62-0364-043	RES. CE 150, 1/4W, 5%
R1,R8,R11	62-0364-055	RES. 470, 1/4W, 5%
R3,4,5,6,10	62-0364-068	RES. 1600, 1/4W, 5%
L2		
D1,D2	62-0565-001	DIODE
A3P7	62-1389-005	CONNECTOR_PLUG,6-PIN
TP-1&-2	62-2725-001	POINT TEST 0.200" CENTER
J1	62-2845-001	RECEPTACLE STRT 2 PIN
J7	62-2845-005	RECEPTACLE STRT 6 PIN
U1-U3	62-4238-001	OPTOISOLATOR OPTII264A
Q1,Q2,Q3	62-4239-001	TRANSISTOR NPN 2N3904

Figure 4.8 A10 Footswitch Isolatic



Appendix A - Fault Codes

NOTE: Although many of the Possible Causes of the Err Codes are digital IC's, their failure rates are very low. Eliminate other possibilities (such as IC sockets, open pull up resistors or shorted bypass capacitors) before changing them.

<u>ACC CODES</u>	<u>MEANING</u>	<u>POSSIBLE CAUSES</u>
FS	Monopolar Footswitch Shorted.	<ul style="list-style-type: none"> -Monopolar footswitch pressed while turning power on. -Faulty ribbon cable or connector. -Shorted Footswitch. -Shorted bypass capacitors or open pull up resistors on control lines. -A3U11 Failure (8255).
LH	Left Handswitched Monopolar Accessory Shorted.	<ul style="list-style-type: none"> -Left Handswitched Accessory pressed while turning power on. -Shorted Left Handswitched Accessory -Faulty ribbon cable or connector. -A5 U2 or U3 shorted. -Shorted bypass capacitors or open pull up resistors on control lines. -A3U11 Failure (8255).
rH	Right Handswitched Monopolar Accessory Shorted.	<ul style="list-style-type: none"> -Right Handswitched Accessory pressed while turning power on. -Shorted Right Handswitched Accessory. -Faulty ribbon cable or connector. -A5 U5 or U6 shorted. -Shorted bypass capacitors or open pull up resistors on control lines. -A3U11 Failure (8255).
bP	Bipolar Accessory Shorted.	<ul style="list-style-type: none"> -Bipolar Accessory pressed while turning power on. -Shorted Bipolar Accessory. -Faulty ribbon cable or connector -A5 U1 shorted. -Shorted bypass capacitors or open pull up resistors on control lines. -A3U11 Failure (8255).
CP "xx"	Control Panel key Note: "xx" displayed in Bipolar Power window corresponds to the stuck key using Figure 2.1 as a reference. Multiple keys show as "88".	<ul style="list-style-type: none"> -Control Panel key pressed while turning power on. -Shorted Control Panel key. -Faulty ribbon cable or connector. -A2Q4, Q5 or Q6 shorted. -A2U2 (8279) or A2U4 (NE5090) Failure.



<u>Err CODES</u>	<u>MEANING</u>	<u>POSSIBLE CAUSES</u>
1.0	Read/write of 8031 internal memory is impaired.	-Faulty A3U3 (8031 microprocessor). -RF Shield not properly installed.
1.1	Read/write of external memory is impaired.	-Faulty A3U2 (DS1220). -Shorted or open bus lines. -RF Shield not properly installed.
2.x (“x” is for mfr’s. internal use.)	Program Memory CRC error.	-Faulty A3U1 (27C256). -Faulty A3U3 (80C31). -Shorted or open bus lines.
3.0	Calibration Memory CRC error.	-Calibration incomplete when exited CAL mode. -Faulty A3U2 (DS1220). -Shorted or open bus lines. -Faulty A3U6 or U8.
4.0	First Stage of Watch Dog Timer incorrect. Note: If error is very large, the unit cannot tell which stage is incorrect.	-A3U7, R5, or C5 incorrect. -Microprocessor frequency incorrect (A3Y1 or U14). -A3U6 or U10 incorrect.
4.1	Second Stage of Watch Dog Timer incorrect. Note: If error is very large, the unit cannot tell which stage is incorrect.	-A3U7, R6, or C6 incorrect. -Microprocessor frequency incorrect (A3Y1 or U14). -A3U6 or U10 incorrect.
4.2	Watchdog Timer Pulse is outside of allowed timing window.	-Faulty A3U1 (27256). -Faulty A3U3 (8031). -Clock frequency incorrect (A3Y1 or A3U14).
5.0	RF PA current too low during power on tests.	-RF Output transistor(s) (A4Q1-Q8) faulty. -Open fuse on A4 assembly. - +5Volt supply faulty A8VR1 connection. -RF power supply faulty or not connected. -A8Q1 connections faulty. -Gate or base signals faulty or not connected. -Isense circuitry faulty. -faulty relays A5K1-K6.
5.1	RF PA current too high during Power on Tests.	-RF Output transistor(s) (A4Q1-Q8) faulty. -Gate or base signals faulty. -A4D10 shorted. -Isense circuitry faulty. -faulty relays A5K1-K6.
5.2	RF PA current too high for power setting.	-RF Output transistor(s) (A4Q1-Q8) faulty. -Gate or base signals faulty. -A4D10 shorted. -Isense circuitry faulty. -faulty relays A5K1-K6. -RF shield improperly installed. -Vsense circuit faulty (high power cut only)



<u>Err CODES</u>	<u>MEANING</u>	<u>POSSIBLE CAUSES</u>
6.0	Attempted entry to guarded memory location or CPU failure.	-RF Shield not properly installed. -Faulty A3U3 (8031). -Faulty A3U1 (27256).
7.0	Watchdog Timer does not disable RF drive.	-A4R8 shorted. -Faulty A3U5 (74LS14). -Faulty A3U13 (74LS140). -Faulty A3U23 (1M339). -A3 +12V supply incorrect. -Faulty A3R50 or R51.
10.X	Incomplete Calibration Note: The suffix determines which mode was not calibrated.	-10.0 Multiple modes not calibrated on return to CAL top level menu. -10.1 Pure -10.2 Blend 1 -10.3 Blend 2 -10.4 Blend 3 -10.5 Standard Coag -10.6 Spray Coag -10.7 Bipolar Coag -10.8 Bipolar Cut -10.9 ARM
11.X	Nonmonotonic calibration; i.e.; at least one calibration point is lower than the preceding point. The suffix determines which mode is nonmonotonic.	-11.0 More than one mode is nonmonotonic on return to CAL top level menu. 11.1 Pure -11.2 Blend 1 -11.3 Blend 2 -11.4 Blend 3 -11.5 Standard Coag -11.6 Spray Coag -11.7 Bipolar Coag -11.8 Bipolar Cut
12.0	Power setting in data memory doesn't match display.	-RF Shield not in place. -Faulty A2U1 (8279). -Faulty A3U3 (8031). -Faulty bus connection to A2J2
12.1	A3U11 RESET after power up.	-RF Shield not in place. -Faulty A3C67. -Faulty A3U11.
12.2	Safety Critical Variables do not match.	-Faulty A3U2 (DS1220). -Faulty A3U3 (80C31). -Shorted or open bus lines. -Faulty A3U9 (74LS138)
13.1	Stuck CAL switch.	-CAL Switch (A3S1) is stuck or held for more than 30 seconds. -Faulty A3R54 -Faulty A3U11



<u>Err CODES</u>	<u>MEANING</u>	<u>POSSIBLE CAUSES</u>
21.0	ARM voltage less than or equal to 0.4V.	<ul style="list-style-type: none"> -Faulty A5Q2 or Q3. -A3U21 or VR2 faulty. -Bent pin on ribbon cable. -Shorted bypass cap on VARM line. -Shorted VARM sense line. -Shorted A5T4.
22.0	Base Voltage drive (VBASE) is too low during Power On Self Test.	<ul style="list-style-type: none"> -Test jumper A3TP3 to A3TP22 is still installed. (Remove it.) -Faulty A8Q1 or connections. -+5V Over Voltage Shutdown Circuit malfunction. -Base voltage Check circuitry (A3R64, R63, C69, U26B) failure. -Any failure in the VBASE circuitry.
22.1	Base Voltage drive (VBASE) is too high during Power On Self Test.	<ul style="list-style-type: none"> -A8Q1 shorted to supply. -Base voltage Check circuitry (A3R64, R63, C69, U26B) failure. -Any failure in the VBASE circuitry.
22.2	Base Voltage drive (VBASE) too high in Run Mode.	<ul style="list-style-type: none"> -Unit calibrated without load or too high a load Recalibrate with rated load connected to unit. -A8Q1 shorted to supply. -Base voltage Check circuitry (A3R64, R63, C69, U26B) failure. -Any failure in VBASE circuitry.
23.0	Waveform too low during Power on self tests.	<ul style="list-style-type: none"> -Waveform detection circuitry (A3U27A, R66, R65, C70, U26C) malfunction. -Ripple on +12V supply. -Tone detector or tone generator circuitry failure keeping waveform drive off.
23.1	Waveform too high during Power on self tests.	<ul style="list-style-type: none"> -Waveform detection circuitry (A3U27A, R66, R65, C70, U26C) malfunction. -Ripple on +12V supply.
23.2	Waveform too high in Run Mode.	<ul style="list-style-type: none"> -Waveform detection circuitry (A3U27A, R66, R65, C70, U26C) malfunction. -Ripple on +12V supply. -Stuck address lines to A3U10 or U17.
24.1	Tone detector can't disable RF.	<ul style="list-style-type: none"> - Failure in tone detect circuitry (A3U26D, C71, D11, D12, R68, R69, R70, R22 prevents TONEDET from pulling low during power on self test.



