

Service Manual

Diagnostic Ultrasound System

Falcon 2101, Falcon 2101EXL,

Hawk 2102, Hawk 2102XDI, Hawk 2102EXL, Surgical Hawk 2102XDI/EXL

This manual covers all existing versions (as of May 2003) of the 2100 series scanners.



World Headquarters: Mileparken 34 • DK-2730 Herlev • Denmark
Tel.: +45 4452 8100 • Fax +45 4452 8199 • www.bkmed.com • e-mail: support@bkmed.com

1	General Information
2	Service Notes
3	Checking Procedure
4	Trouble Shooting
5	Adjustment Procedure
6	Mechanical Parts
7	Preventative Maintenance
8	Theory of Operation
9	System Interconnections
10	

Section 1

GENERAL INFORMATION

CONTENTS	PAGE
1 Safety Aspects	1-2
1.1 Terms and Symbols used	1-2
1.2 WARNINGS and CAUTIONS:.....	1-3
2 System Overview	1-4
2.1 Front View	1-4
2.2 Rear Connectors	1-5
2.3 System Configuration	1-6
2.4 Configuration Upgrade	1-6
2.5 Modules and PC Boards	1-7
3 Revision System	1-8
4 Special Tools and Equipment.....	1-9
4.1 Checking Procedure (Section 3)	1-9
4.2 Troubleshooting (Section 4)	1-10
4.3 Adjustment Procedure (Section 5)	1-10
4.4 Mechanical Parts (Section 6)	1-10
4.5 Preventative Maintenance (Section 7)	1-10
4.6 Electrical Safety Test.....	1-10

1 Safety Aspects

The Falcon 2101/ Hawk 2102 System complies with IEC 60601-1 safety class I.

The Falcon 2101/ Hawk 2102 System is classified as follows:

- Array Input Module: Type B (Body)
- Single-element Transducer Module: Type B (Body)
- ECG Input Module: Type BF (Body Floating)

1.1 Terms and Symbols used

Throughout this manual the following terms are used to indicate a situation where safety precautions are required:

"WARNING": Indicates a situation involving risk of injury or loss of life to personnel or patient.

"CAUTION": Indicates a situation involving risk of damage to the instrument or other equipment connected.













Symbol	Name	Description
	ATTENTION	Consult ACCOMPANYING User Guide (BB0340) when this sign is encountered on the instrument, to avoid reducing its safety
	Potential Equalisation	Terminal connected to the chassis. Should be connected to corresponding terminals on other equipment to eliminate potential differences.
	Protective Earth	Additional Protective Earth
	Type CF	CF: Isolated from earth. Maximum Patient Leakage Current under: Normal Condition $\leq 10\mu\text{A}$, Single Fault Condition $\leq 50\mu\text{A}$
	Type BF	BF: Isolated from earth. Maximum Patient Leakage Current under: Normal Condition $\leq 100\mu\text{A}$, Single Fault Condition $\leq 500\mu\text{A}$
	Type BF	BF, DEFIBRILLATOR-PROOF
	Type B	B: Maximum Patient Leakage Current under: Normal Condition $\leq 100\mu\text{A}$, Single Fault Condition $\leq 500\mu\text{A}$
IP57	SEALING	Dust and immersion protected according to IEC Publication 529
	Stand-by	Push button for switching the scanner from stand-by to active. (The power supply cord is the means of separation from the main power supply.)
	Off	Main power supply off
	On	Main power supply on
	Non-ionising radiation	Ultrasound Scanner emits acoustic radiation
	STERILE	Device is in a sterile condition

Table 1. IEC safety symbols

1.2 WARNINGS and CAUTIONS:

For your own and others safety please read the following carefully:

Warnings:

- Opening the instrument can expose live parts.
- Any work done on the open instrument with power on must only be done by B-K Medical or their authorised representatives, who are aware of the hazards involved.
- Any repair on the 2101/2102 must be followed by an electrical safety test to verify a continuous safe operation of the system.
- Only the original mains cable must be used
NEVER USE EXTENSION CABLES!!
- The 2101/2102 contains a Lithium battery. Under no circumstances must this battery be removed or replaced by the user as there is danger of explosion.

Personal Safety:

Be aware that there may be a risk of infection due to contaminated equipment, especially puncture guides/needles and transducers. The following precautions should be taken:

At the hospital ask the staff to sterilise transducers and puncture guides before receipt. Consoles must be disinfected as recommended in the User Guide before any repair.

When working with possible infected equipment, use gloves especially if you have open wounds or scratches.

Possible infected equipment must be sterilised before handed over to customers. Follow the recommendations in the Transducer User Guide.

- Always wash your hands after working with the equipment.
- If you scratch yourself on contaminated equipment you should immediately contact the hospital staff or see a doctor.

Cautions:

- Ensure that the two mains voltage selector switches on the rear panel of the power supply are set to match the actual mains voltage.
- Always use correct fuses.
- Switch off all equipment before connecting or disconnecting their interfaces. Failure to do so could damage the equipment.
- A 2101/2102 set up to operate in the 90-132 Volt main voltage range, will be damaged if connected to 230 volt.
- The power supply cord is the means of separating the 2101/2102 from the main power supply.

2 System Overview

2.1 Front View

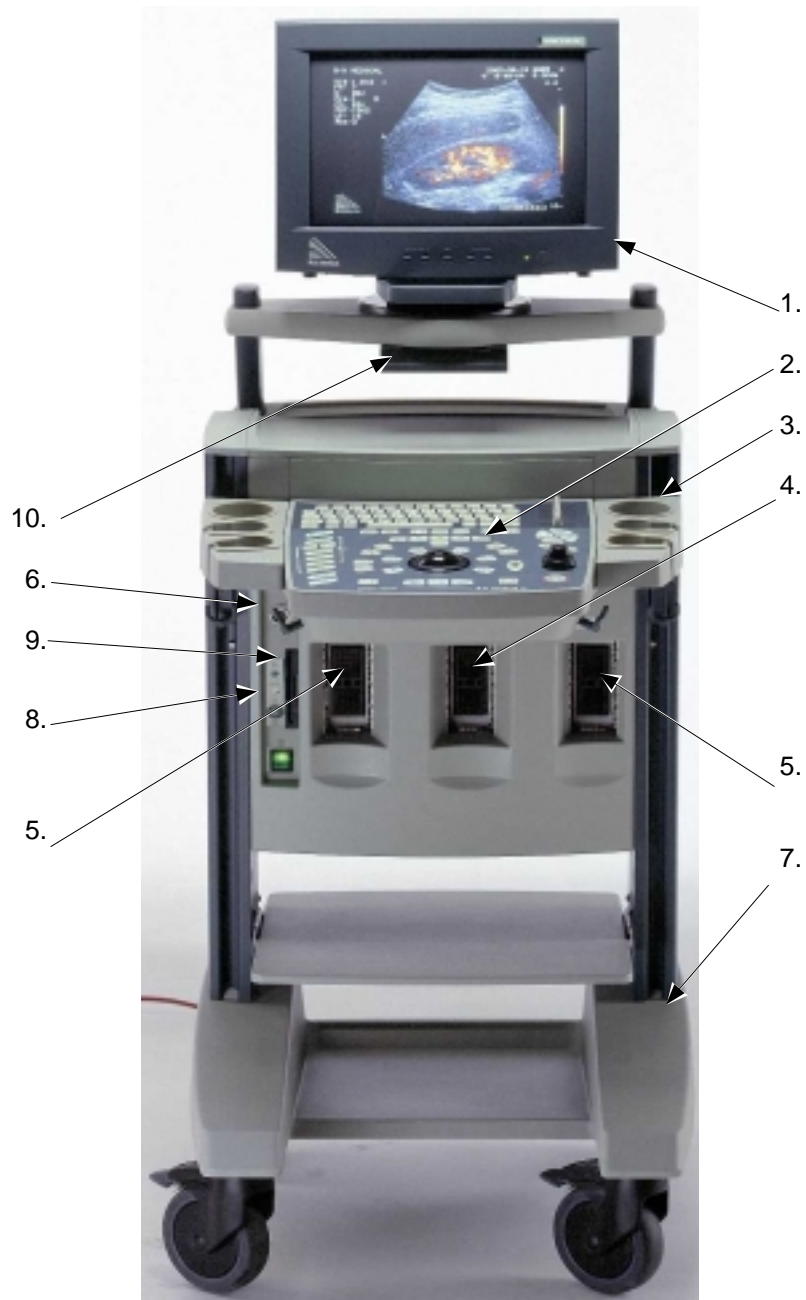

Identify the following main parts.

1. Monitor
2. Keyboard / TGC / Track Ball
3. Gel bottle holder
4. Array Transducer connector(2102)/"Parking"(2101)
5. Array Transducer connector
6. Single Transducer connector (option)
7. Trolley
8. ECG input (option)
9. Floppy Disk Drive
10. CD-ROM drive (option)

2.2 Rear Connectors

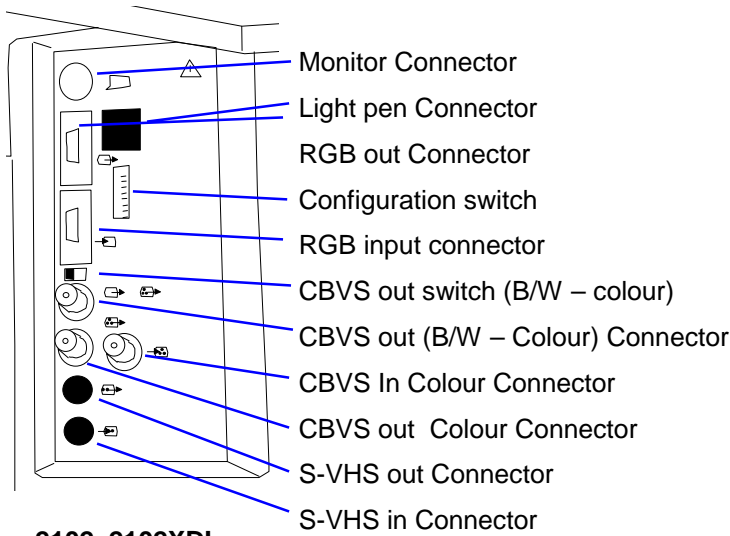

2102, 2102XDI

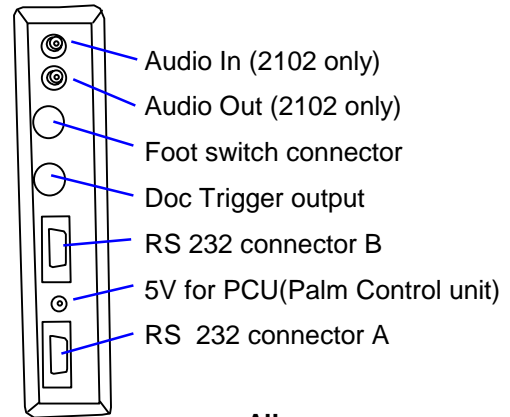

All

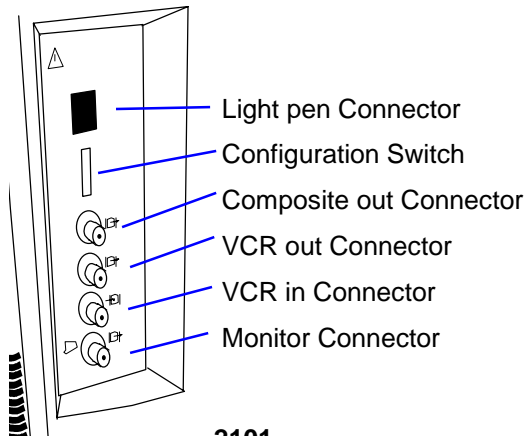

2101

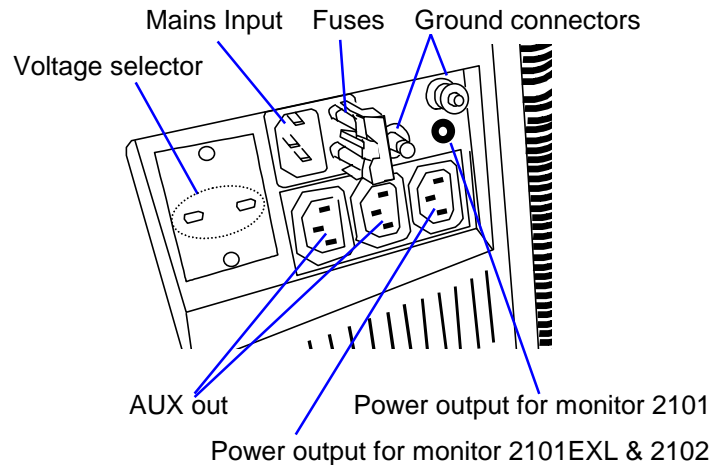

All

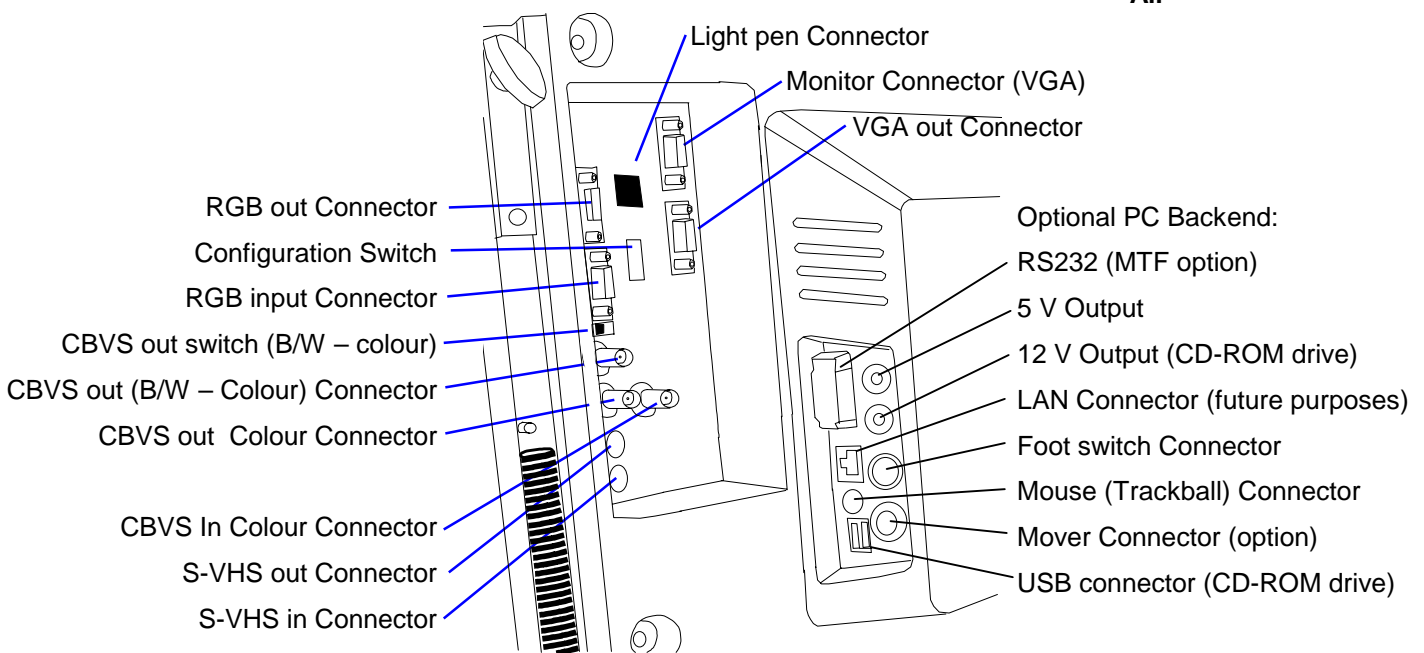

2101/2102EXL

2.3 System Configuration

The Falcon 2101 and Hawk 2102 exists in the below listed versions:

Falcon 2101 for use in B-, and M-mode.

Falcon 2101 EXL use in B-, and M-mode and additional 3D mode

Hawk 2102 for use in B-, Doppler-, and M-mode.

Hawk 2102 XDI for use in B- (Incl. of True Echo Harmonics), Doppler-, and M-mode.

Hawk 2102 EXL for use in B- (Incl. of True Echo Harmonics), Doppler-, and M-mode and additional 3D mode

Surgical Hawk 2102 XDI for use in B- (Incl. of True Echo Harmonics), Doppler-, and M-mode equipped with a Rack Docking System™, PCU (Palm Control unit), and PIP(Picture In Picture) functionality

Surgical Hawk 2102 EXL for use in B- (Incl. of True Echo Harmonics), Doppler-, and M-mode equipped with a Rack Docking System™, PCU (Palm Control unit), and PIP(Picture In Picture) functionality and additional 3D mode

2.4 Configuration Upgrade

The following upgrade kits are available:

Valid for all models:

- UA1254-K – ECG module upgrade kit
- UA1255-K – Single Input module for mechanical transducers
- UA1270-K – Palm Control Unit Kit for scanners delivered before April 2001

Hawk 2102:

- UA1275-K - Harmonic upgrade kit, valid for Hawk 2102 s/n 1824377 or higher

Hawk 2102XDI:

- UA1276-K – PIP upgrade kit, valid for Hawk 2102XDI

Hawk 2102EXL:

- UA1290 PIP upgrade kit, valid for Hawk 2102EXL

2.5 Modules and PC Boards

Board/ subassembly	Model	2101	2101EXL	2102	2102XDI	Surgical Hawk 2102XDI	2102EXL & Surgical 2102EXL
Monitor		ZV0049	ZV0065	ZV0050/51 ²	ZV0060	ZV0060	ZV0065
Video Converter/Mixer board			ZH0743	ZH0691	ZH0691	ZH0699	ZH0743
Video Connector board			ZH0745	ZH0692	ZH0692	ZH0722	ZH0745
VGA connector board			ZH0744				ZH0744
Core board		ZD0753	ZD0771	ZD0762/67 ³	ZD0762/67 ³	ZD0762/67 ³	ZD0767
Front-end board		ZE0731	ZE0731	ZE0724	ZE0724	ZE0724	ZE0724
Delay board		ZE0726	ZE0774	ZE0725	ZE0768	ZE0768	ZE0772
Doppler board				ZD0758	ZD0758	ZD0758	ZD0758
Motherboard		ZH0675/95	ZH0675/95	ZH0695	ZH0695	ZH0695	ZH0695
Power supply		ZG0341	ZG0341/48	ZG0341	ZG0341	ZG0341	ZG0341/48
Keyboard assembly		ZN0006	ZN0006	ZN0009	ZN0009	ZN0009	ZN0009
- Potentiometer Board		ZH0676	ZH0676	ZH0676	ZH0676	ZH0676	ZH0676
- Gain Board		ZH0678	ZH0678	ZH0678	ZH0678	ZH0678	ZH0678
- Tracker Ball		NT0254	NT0254	NT0254	NT0254	NT0254	NT0254
Floppy Drive		UL0018	UL0018	UL0018	UL0018	UL0018	UL0018
ECG Module (UA1254 Option)		ZE0762	ZE0762	ZE0762	ZE0762	ZE0762	ZE0762
Single Module (UA1255 Option)		ZH0709	ZH0709	ZH0709	ZH0709	ZH0709	ZH0709
PC-Backend (6503 Option)		N/A	ZN0377	N/A	N/A	N/A	ZN0377
- Single board PC		N/A	ZN0042	N/A	N/A	N/A	ZN0042
- Frame grabber with connect.		N/A	ZN0043	N/A	N/A	N/A	ZN0043
- Harddisk		N/A	UL0023	N/A	N/A	N/A	UL0023
- Power supply		N/A	ZG0345	N/A	N/A	N/A	ZG0345
- Connection board		N/A	ZH0751	N/A	N/A	N/A	ZH0751
- MCM base		N/A	ZH0752	N/A	N/A	N/A	ZH0752
- MCM Motor Control (option)		N/A	ZH0753	N/A	N/A	N/A	ZH0753
- CD/RW		N/A	ZN0041	N/A	N/A	N/A	ZN0041
- Trackball for PC-Backend		N/A	NT0262	N/A	N/A	N/A	NT0262
- Footswitch for PC-Backend		N/A	UA1215	N/A	N/A	N/A	UA1215

² ZV0050=10" / ZV0051=12"³ ZD0762-sw. < 3.00 / ZD0767 sw. ≥ 3.00

3 Revision System

All PC Boards in the 2101/2102 are described by the board name, Type number, Revision code (ID) and PCB Version.

The *name* of the board indicates the *function* of the board, for example the Delay Board. The name of the board is changed only if the function of the board changes.

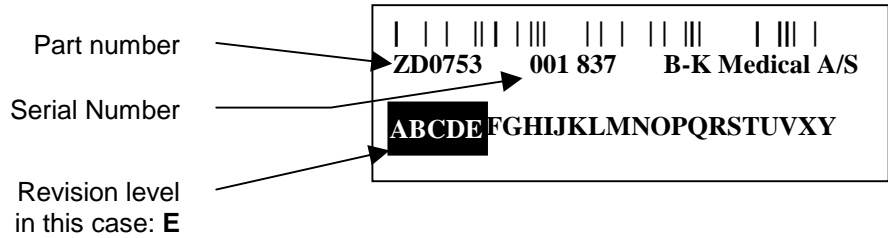

Bar Code Label

The *Part number* of the board, for example ZD0753, is the *order number* of the board. The number is changed if the modification of the existing PCB is found to be too extensive.

The serial number of the board is a unique number used for tracking purposes.

The *revision code* (ABCDEFGH.....) is related to the *modifications* made on the board. The revision letter is marked when modifications are made. When boards are ordered from the B-K Medical stock it is important that the serial number of the scanner is stated. The serial number ensures that the correct revision is shipped.

The PCB version (number e.g. 3) is printed on the circuit board.

Information about Hardware/ Software compatibility can be found in the B-K Medical Hot Line on the support section of www.bkmed.com (requires password)

4 Special Tools and Equipment

The tools and equipment listed below does not include standard tools and commonly used equipment.

4.1 Checking Procedure (Section 3)

- Transducer Phantom, model 254 (WQ 0973) for checking a 2101/2102 system equipped with Array- and Single-element Transducers.
- Transducer Phantom, type 251 (WQ 0972) for checking a 2101/2102 system equipped with the Endosonic Probe 1850.
- Ruler (for checking the size of the image on the monitor)
- Floppy disk 3.5" (for testing the floppy disk drive)
- Blank CD-R (for testing PC Back-end CD Drive – option)

Further it is recommended to bring a 150 ml bottle containing preserving fluid for the phantom(s):

Prescription for preserving fluid:

- 94 ml Glycerol (85%)
- 50 ml Rodalon (10%)
- 1000 ml purified Water

4.2 Troubleshooting (Section 4)

For troubleshooting the power supply

- DVM

4.3 Adjustment Procedure (Section 5)

For adjusting the monitor:

- Nonmagnetic screwdriver
- Ruler (for checking the size of the image on the monitor)
- Colour Analyser (for 2102 and 2101EXL monitor)

For adjusting the monitor friction:

- 4 mm Allen key

4.4 Mechanical Parts (Section 6)

- Static Control Service Kit, type 3M 8501 (WQ 0969) or similar. (when handling the static sensitive PCB's).
- TORX key size 10 and 20. A short TORX key size 20 is necessary in order to get easy access to some screws on the monitor assembly.
- Wrench key for Video converter mounted on the Core Board or CD ROM drive for PC Back-end

4.5 Preventative Maintenance (Section 7)

- Equipment necessary to perform the Preventative Maintenance is the equipment used in the Checking Procedure and Electrical Safety Test.

4.6 Electrical Safety Test

Testers required:

- Safety Tester
- HV Tester
- WB 1275 HV test adaptor for type BF Transducers

High Voltage test plugs required:

- WJ 0246 HV Test Plug for Mains
- WJ 0287 HV Test Plug for ECG (for testing ECG Input Module)
- Electrical Safety Test Record (Enclosed)

2101/2102 Electrical Safety Test Record



Equipment under test	Serial no:	Location:
----------------------	------------	-----------

For INSTRUCTIONS read the back of this sheet.

Test Select	Test		Test Date					Typical value	Test Limits
1	Rigel self test	-						-	-
2	Mains Voltage	-						-	Nominal +/- 10%
3	Insulation Resistance	Mains to Case							5 MΩ
5	Pr. gnd	Console (earth terminal)						0,1 ohm	0,2 ohm
5	Pr. gnd	Transducer connector –array						0,1 ohm	0,2 ohm
5	Pr. gnd	Video shelf						0,1 ohm	0,2 ohm
5	Pr. gnd	Single module connector						0,1 ohm	0,2 ohm
5	Pr. gnd	Monitor						0,1 ohm	0,2 ohm
5	Pr. gnd	ECG (Potentiometer button)						0,1 ohm	0,2 ohm
6	Earth Leakage	Norm.						40 μA	500 μA
6	Earth Leakage	Rev.						80 μA	500 μA
7	Earth Leakage	Norm.						2 μA	1000 μA
7	Earth Leakage	Rev.						120 μA	1000 μA
8	Enclosure Leakage	Norm.							100 μA
8	Enclosure Leakage	Rev.							100 μA
11	Patient Leakage	Norm.							100 μA
11	Patient Leakage	Rev.							100 μA
A	2.2 kV (DC)	Mains							No Flash over
B	2.2 kV (DC)	ECG							No Flash over

Signature

The test complies with IEC 60601-1 regulations for medical equipment, safety class I, Type B (ECG type BF).

Important:

High Voltage testers deliver hazardous currents. Therefore these testers should only be operated by technicians who are aware of the hazards involved.

Disconnect transducers and accessories from the equipment under test. Test limits are valid only for the equipment itself without any applied part(s) connected.

The complete test must always follow immediately after a repair made on the 2101/2102 Ultrasound Scanner, and always on the fully assembled unit.

Protective GND: General remarks and settings for Test no. 5:

Tester: Rigel 233
Cables: Mains cable for scanner; clip/probe lead (Rigel accessories)
Basic settings: 2101/2102 mains switch ON; Rigel switch settings: Class=I, Type: B (For ECG test type BF)
Calibrate Rigel: Connect clip/probe lead between PROBE and GND in IUT POWER socket; Press TEST and zero ohm-meter.

Connect the scanners Main cable from IUT POWER (Rigel) to power inlet on the scanner.

1. Connect the clip/probe lead between PROBE (Rigel) and the left GND connector on the back of the scanner. Press the TEST button and record the resistance. Disconnect the power cable for the monitor.

Note: As the test current is 25 Amps. it is important that the clip/probe lead is held firmly against, or clipped to the GND connector before the TEST button is pressed !

2. Move the clip/probe to the metal on one of the array transducer connectors. Press the TEST button and record the resistance.
3. Move the clip/probe to on of the metal screws holding the video shelf on the scanner. Press the TEST button and record the resistance.
4. If single module installed: Move the clip/probe to the metal ring on the single module connector (if installed). Press the TEST button and record the resistance.
5. Move the clip/probe to on of the metal on the back of the monitor. Press the TEST button and record the resistance.
6. If ECG installed: Set the Rigel tester to type BF. Remove the top on one of the potentiometer buttons on the ECG module. Move the clip/probe to the nut on the potentiometer button. Press the TEST button and record the resistance. Set the Rigel tester to type B again.

Leakage Current: General remarks and settings for test no. 6 and 7.

Test 6 measures Earth Leakage current – normal condition

Test 7 measures Earth Leakage current – single Fault Condition (supply open)

Tester: Rigel 233
Cables: Mains cable for scanner;
Basic settings: 2101/2102 mains switch ON; Rigel switch settings: Class = I, Type: B,

1. Connect the mains cable for the scanner to the IUT POWER outlet (Rigel) to power inlet on the scanner
2. Position the Rigel Normal-Reverse switch in *Normal* and record the current.
3. Position the Rigel Normal-Reverse switch in *Reverse* and record the current.
4. Repeat the above test for test no. 7.

High Voltage Test: General remarks and settings for A and B

Tester: HV Insulation Tester JP15
Cables: HV probe and GND lead (JP15 accessories)
Adaptors: HV test plug for mains WJ0246, HV test plug for ECG Module WJ0287
Connections: Insert the HV test plug for mains into socket for mains input, and HV test plug for ECG Module into ECG socket. Connect the JP15 GND with the scanners BNC GND using the JP15 GND lead.
Basic settings: Mains switch on scanner ON; on JP15: Connect HV probe cable with switch plug into socket "HT"/"sw". Select 1µA and 7,5 kV. "Volume" to mid position and HV potentiometer fully anti-clockwise.

Test A: Insert tip of HV probe into the HV test plug for mains. Press button on HV probe handle while increasing the HV to **2.2 kV (DC)** read from the voltmeter. Apply this voltage for **maximum 5 sec.** There must be no flash over nor breakdowns indicated by full deflection on the µA-meter.

Test B: Insert tip of HV probe into HV test plug for ECG Module and repeat above test.

Section 2

SERVICE NOTES

Service Notes

To improve the performance of the Falcon and Hawk Ultrasound System 2101/2102, small changes in the hardware and firmware may be made. All information about these changes, and any other change or correction to this Service Manual will be released in the form of Service Notes in the Medical Hotline.

Note

All existing and future Service Notes concerning the 2101 Falcon or 2102 Hawk system should be placed in this section.

Edition Number

If any major changes are made to the 2101 Falcon or 2102 Hawk system and/or the Service Manual, a new edition will be released.

Any new editions can be recognized by the edition number given in the footer.

The serial numbers from which each edition is valid are listed on the front page.

This page is left blank intentionally

Section 3

CHECKING PROCEDURE

CONTENTS	PAGE
3.1 Introduction	2
3.1.1. Necessary Equipment to Perform the Checking Procedure	2
3.2. Basic Checks	2
3.2.1. Visual Inspection	2
3.2.2. Monitor	3
3.2.3. Before Power Up	3
3.2.4. Power Up	4
3.2.5. Test Oscillators	5
3.3. Monitor Checking	14
3.4. Transducer Inputs	14
3.5. Track Ball	15
3.6. Gain/TGC	15
3.7. Size	15
3.8. Focusing	16
3.9. Frame Rate	16
3.10. Image Processing	16
3.11. Persistence	16
3.12. Puncture	16
3.13. Zoom	16
3.14. Measure	17
3.15. Image review	17
3.16. M-mode	17
3.17. Split Screen	17
3.18. Image Storage	17
3.19. Audio/Spectral Doppler (only 2102)	18
3.20. CFM (only 2102)	18
3.21. PIP (only for 2102 with the PIP option)	19
3.22. 3D system (6503 option)	20
3.22.1. Basic check – start up & signal transfer to/from scanner	20
3.22.2. Acquisition	20
3.22.3. CD-RW drive	21
3.22.4. ECRM option	22
3.22.5. Pull back option	23
3.22.6. 2050 3D scanning	23
3.22.7. MTF (Magnetic Tracked Freehand) option	24

3.1. Introduction

The Checking Procedure is to verify proper operation of the main functions of the 2101/2102 System.

The procedure should be used during installation, incoming inspection, regular maintenance and before and after repair.

The procedure is arranged in sections and must be followed from the beginning when performed.

Notes

If the Checking Procedure cannot be performed successfully or if there is a specific fault in the System, refer to Section 4, TROUBLESHOOTING or Section 5, ADJUSTMENT PROCEDURE.

The Checking Procedure does not include a check of the different transducer types.

If in doubt about the functions of the 2101/2101EXL/2102/2102XDI/2102EXL you should consult the user guide BB0340/BB1086/BB0360/BB0950/BB1075.

Important!!

Any inside repairs performed on the 2101/2102 must be followed by an Electrical Safety Test.

3.1.1. Necessary Equipment to Perform the Checking Procedure

- Transducer Phantom, model 254 (WQ 0973) for checking a 2101/2102 system equipped with Array- and Single-element Transducers.
- Transducer Phantom, type 251 (WQ 0972) for checking a 2101/2102 system equipped with the Endosonic Probe 1850.
- Ruler (for checking the size of the image on the monitor)
- Floppy disk 3.5" (for testing the floppy disk drive)
- Array Transducer (Linear or Convex).
- Sector Transducer (for systems equipped with Single-element module)

Note: If a phantom is not available the human body is a good alternative.

3.2. Basic Checks

3.2.1. Visual Inspection

1. Check the overall appearance of the 21/012102.

Especially check for scratches and stain's on the paint.

3.2.2. Monitor

1. Check that the monitor is securely fastened on its base and is easy to rotate.

3.2.3. Before Power Up

1. Check that the two voltage selector switches found on the rear panel of the Power Supply are set for the actual mains voltage.
2. Check the rating of the primary fuses:

If 230 V AC: T 6.3 A H, 250V (Time lag high breaking capacity)
If 115 V AC: T 8 A H, 250V (Time lag high breaking capacity)
3. The 2101/2102 System complies with the IEC 60601-1 safety regulations and as such it **must** be connected to a mains outlet having a safety ground connection. Therefore: Check that the 2101/2102 mains cable is terminated with a three-pole plug that fits a three-pole mains outlet. For safety reasons do not use extension cables!

3.2.4. Power Up

1. Disconnect all accessories from the 2101/2102 and connect any transducer available which fits the Array Input Module.
2. Switch On the 201/2102.
After a few moments the power up (boot) sequence is completed.
3. Verify that the monitor opening layouts are shown in Fig. 3.3 -1. Note that the menu shown (settings) differs from transducer type.





Fig. 3.3-1. *The default display.*

4. Check that the following is displayed on the monitor:
 - the current date and time
 - a white “Asteric” (“Freeze”-mode)

Note: If the displayed date and time is incorrect, press **Setup** to display the Setup menu.
Press **F2** to display the Date /Time menu and use the track ball to go to the field to adjust. Press  to toggle the menu's.
Press F1 for Next Page
To exit the menu press **Setup**.

3.2.5. Test Oscillators

1. Connect an electronic transducer to the 2101/2102.
2. Switch On the scanner.
3. Press **Shift, Alt** and  to select the Test menu
4. Select the Scancon Test oscillator by pressing **F3** and unfreeze
Toggle between Scancon test 1,2 and 3 by pressing **F3**, and compare to the images below. To bring up the test menu again, press **Shift, Alt** and 
Note that the actual image on the scanner depends on various settings e.g. size and transducer type.

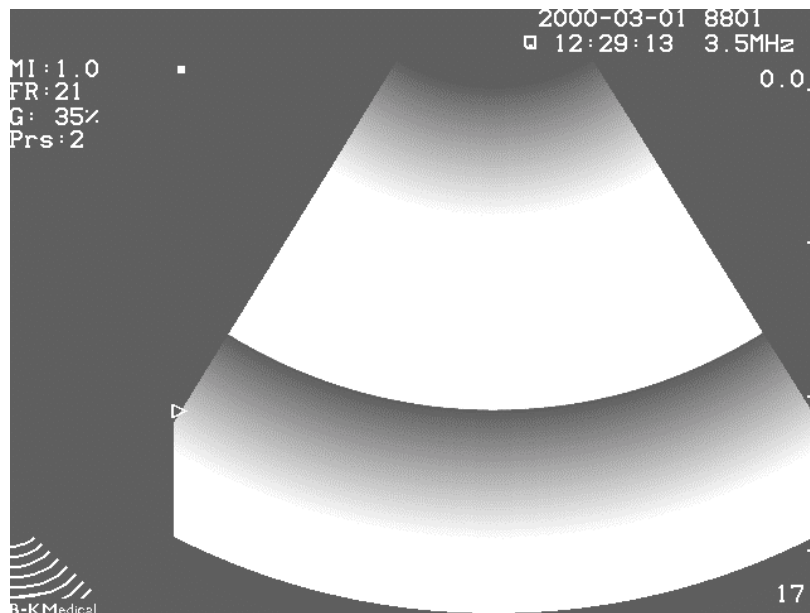

Fig. 3.3-2. Scancon Test Osc. 1 and 2. Check that image is going from black to white

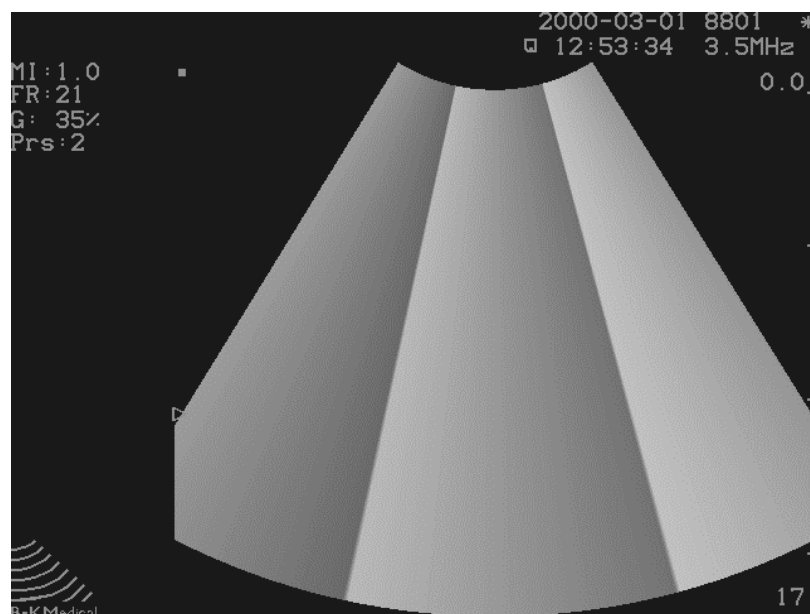

Fig. 3.3-3. Scancon Test Oscillator 3 - Greyscale horizontally.
Note ! this image might flicker dependable on transducer type and size of image

5. Exit the Scancon Test by keeping **F3** depressed for 1 second.

6. Select the Input Test Oscillator by pressing **F1**. Compare to the image below.

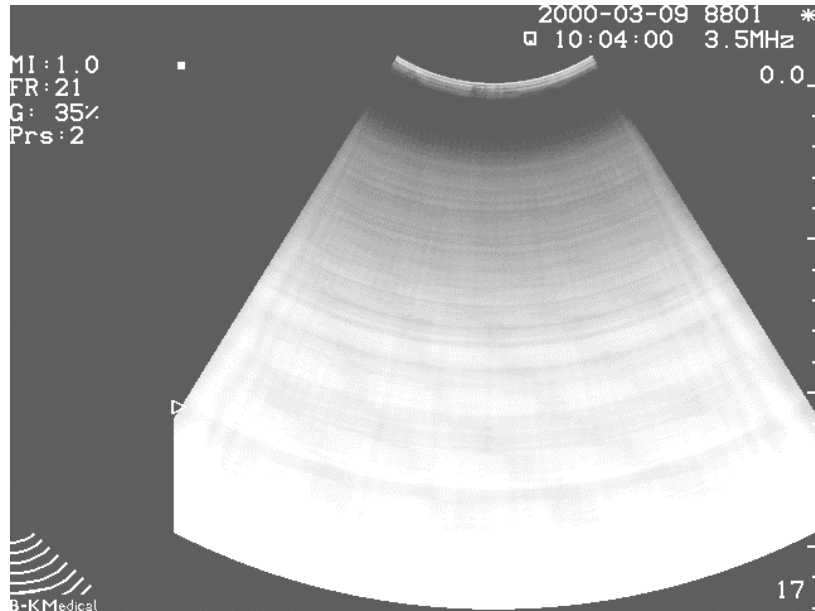



Fig. 3.3-4. *Input Test Oscillator.*

7. Exit the Input Test Oscillator by pressing **F1**.

8. Switch off the scanner and disconnect all transducers from the 2101/2102.
9. Turn on the scanner and after the boot sequence press **Shift, Alt** and .
10. Select the Delay Test oscillator by pressing **F2** and unfreeze The image should now look like the figure below i.e. concentric bands which gradually goes from black to white (light grey) and then back to black.
Note ! The actual number of concentric bands depends on the size selected.

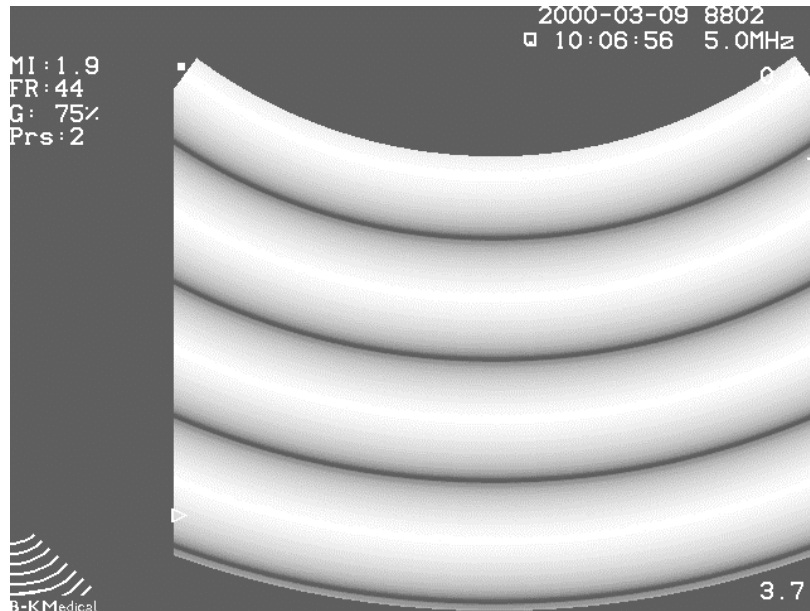



Fig. 3.3-5. *Delay Test Oscillator 1*

11. Press **Shift, Alt** and  to access the Test Oscillator again.
12. Press **F2** to start Delay test oscillator 2. The image should now look like the figure below i.e. 6/8 concentric bands which consist of a number of white (light grey) blocks separated by 48/64 narrow black radial lines.
 Note ! If bands are missing from the sides it could be because of the user setup. In that case make a backup of the 8802 set-up on a floppy disk and reset the 8802 set-up. Remember to load the customer setup again after the test.

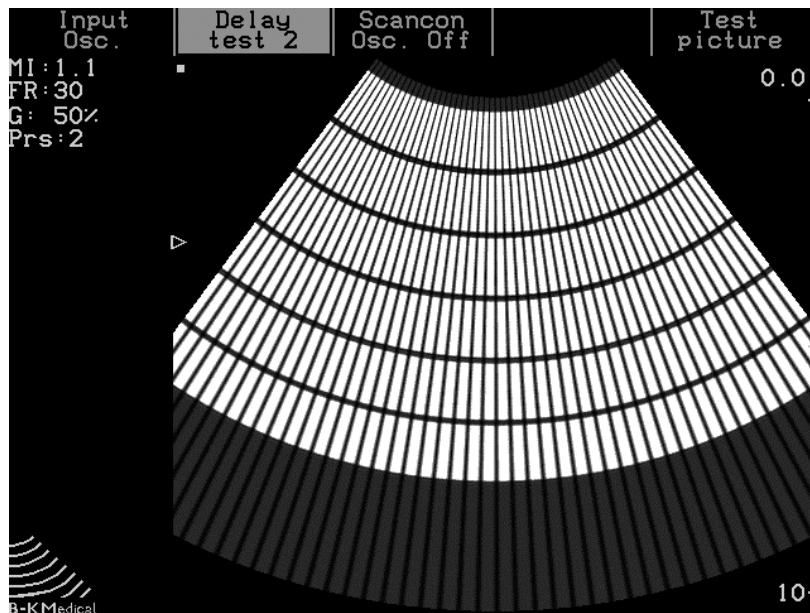

Fig. 3.3-6. Delay Test Oscillator 2 on 2101

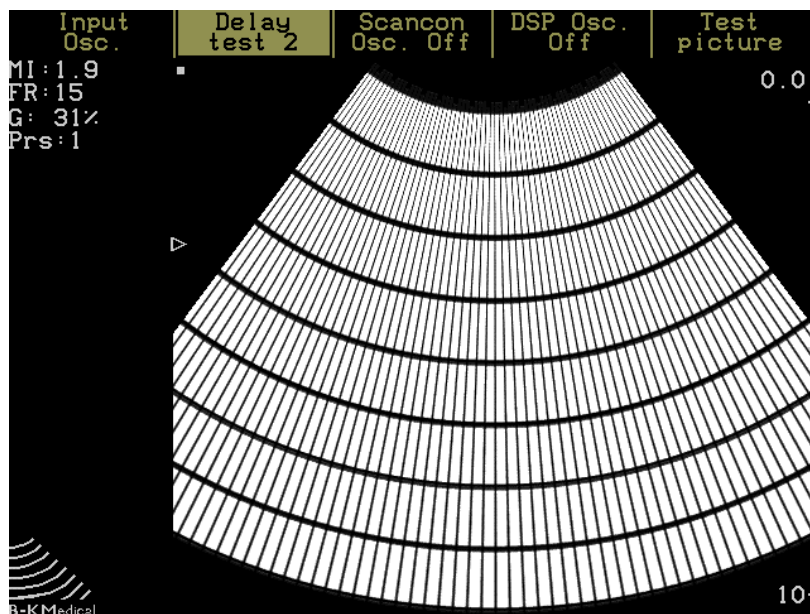

Fig. 3.3-7. Delay Test Oscillator 2 on 2102

13. Turn the gain down to see if all bands can be adjusted to dark grey and turn the gain up again to see if the bands appears white again.

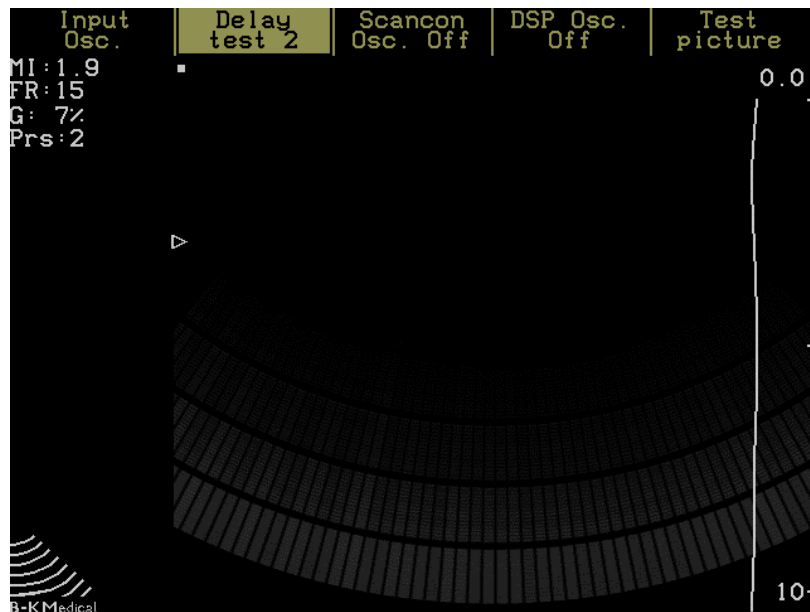

Fig. 3.3-8. Delay Test Oscillator 2 with gain turned down – test image should fade out

14. Press **F2** to start Delay test oscillator 3. The image should now look like the figure below i.e. 24/32 radial fields separated by narrow white lines. The fields should be white from top to bottom and then gradual decrease in length going from right to left.
 Note ! On 2101 the left line should be a narrow line where as on the 2102 it should be a wide field.

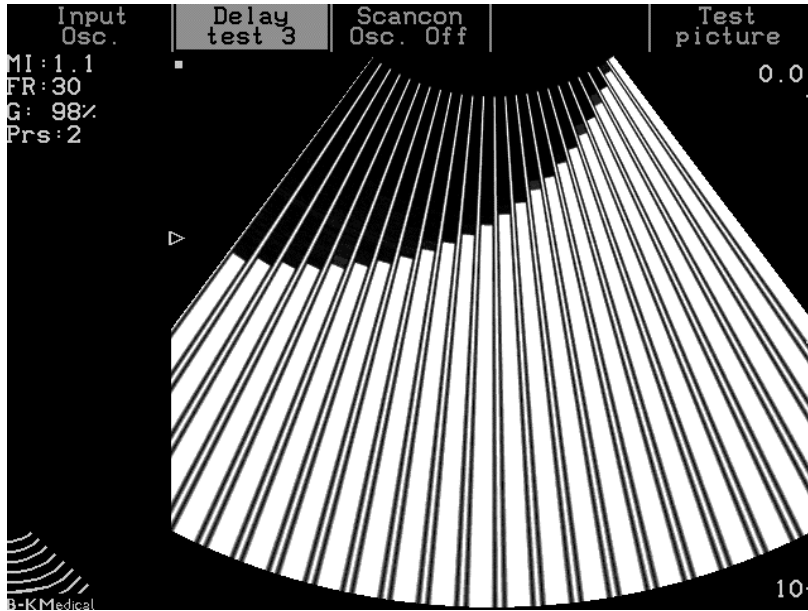

Fig. 3.3-9. Delay Test Oscillator 3 (2101).

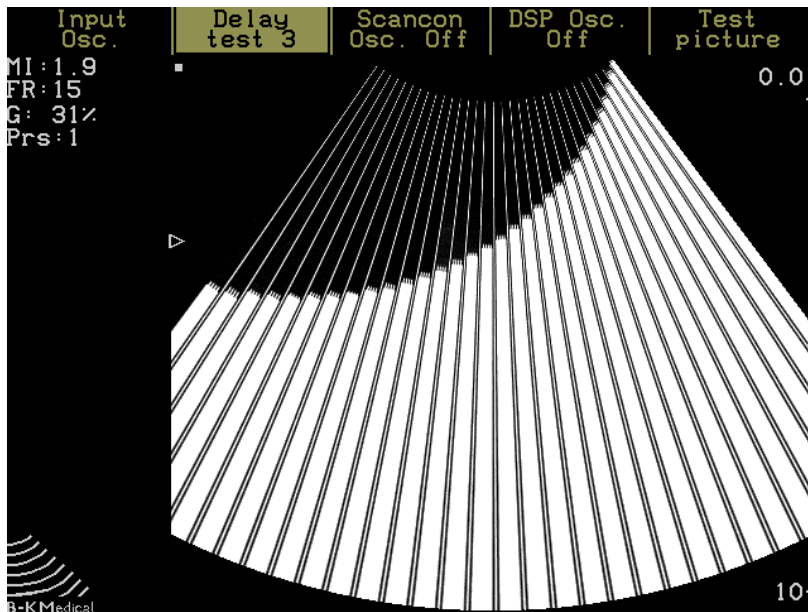



Fig. 3.3-10. Delay Test Oscillator 3 (2102).

15. Turn the gain down to see if all bands can be adjusted to dark grey and turn the gain up again to see if the bands appears white again.
16. Switch off the scanner

2102 Only !

(for 2101 continue with step 24)

17. Connect an electronic transducer to the 2102 and switch on the scanner.
18. Press **CFM**
19. Select the test menu by pressing Press **Shift, Alt** and .
20. Select DSP osc. by pressing **F4** and then press **Freeze** and compare to the figure below.

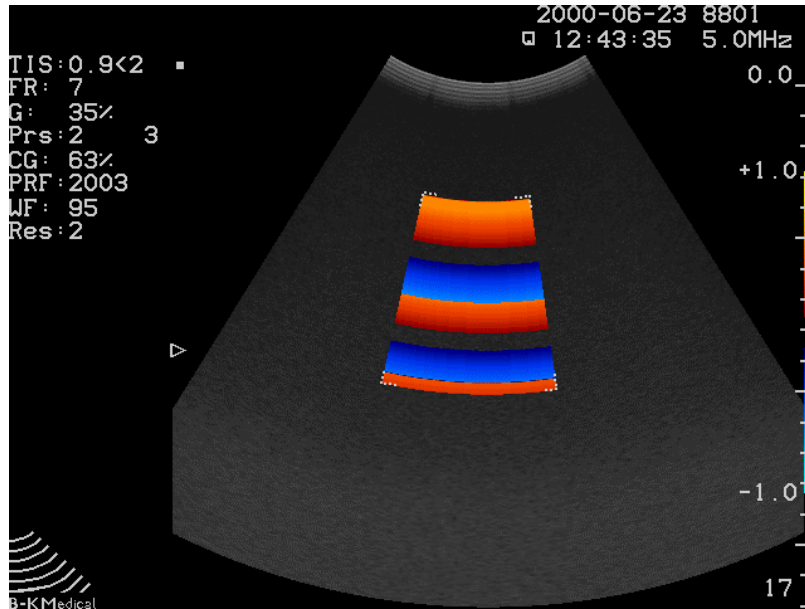
**Fig. 3.3-11.** Doppler test Oscillator 1.

21. Press **Shift, Alt** and  to activate the Test menu.
22. Press **F4** to activate Test oscillator Disp. Osc.2
23. Press **Freeze** twice (freeze and then unfreeze) and compare to the Figure below.

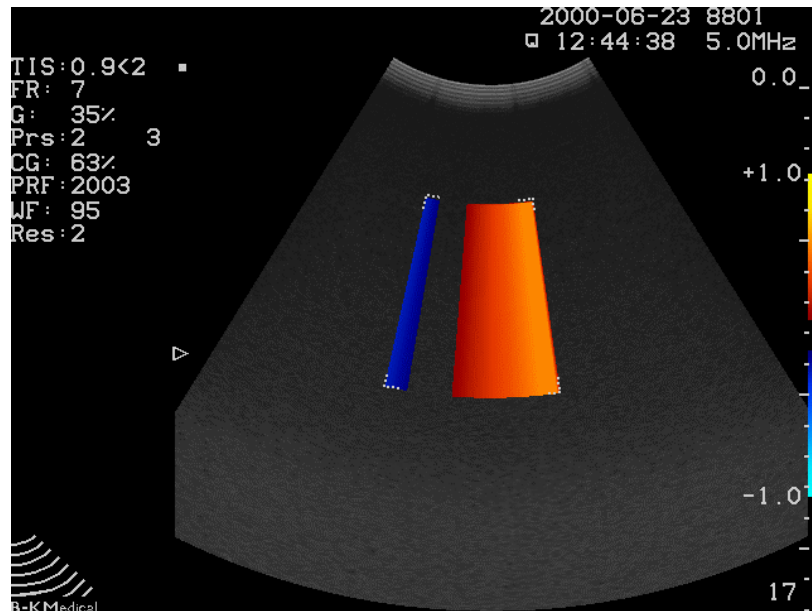

Fig. 3.3-12. Doppler test Oscillator 2.

24. If the 2101/2102 has a single input module then switch off the scanner and disconnect all transducers from the 2101/2102.
25. Turn on the scanner.
26. Start the Single Input Test Oscillator by pressing **Shift, Alt, and Z**, select e.g. 8539 (**F2**) and unfreeze. Compare to the image below.

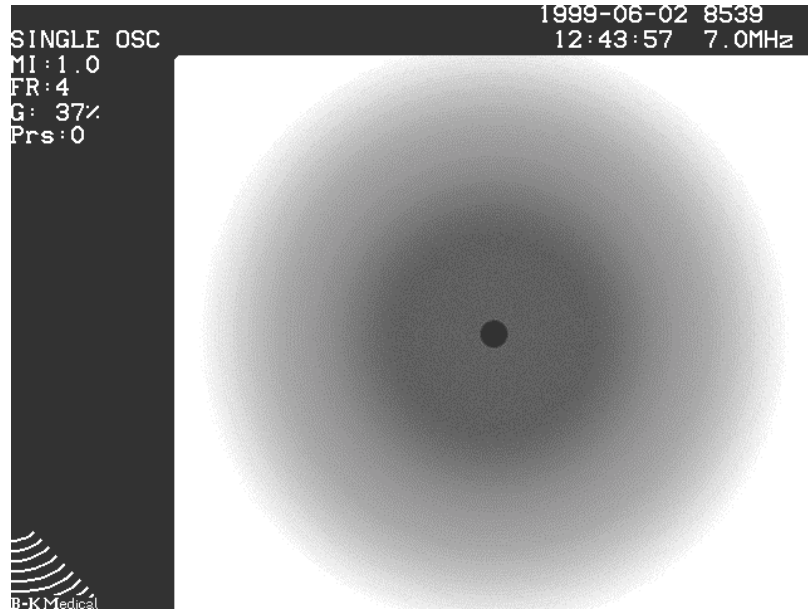

Fig. 3.3-13. Single Input Test Oscillator.

27. Exit the Single Input oscillator by pressing **Shift, Alt, and Z**.
28. If the 2101/2102 has an ECG option then connect a transducer and unfreeze the image.
29. Press **S (HR)** to get the ECG Curve on the screen.
30. Select the ECG test by pressing **Shift, Alt, S**. Compare to the image below. Note ! The amplitude and position of test curve depends of the setting of the ECG potentiometers.)

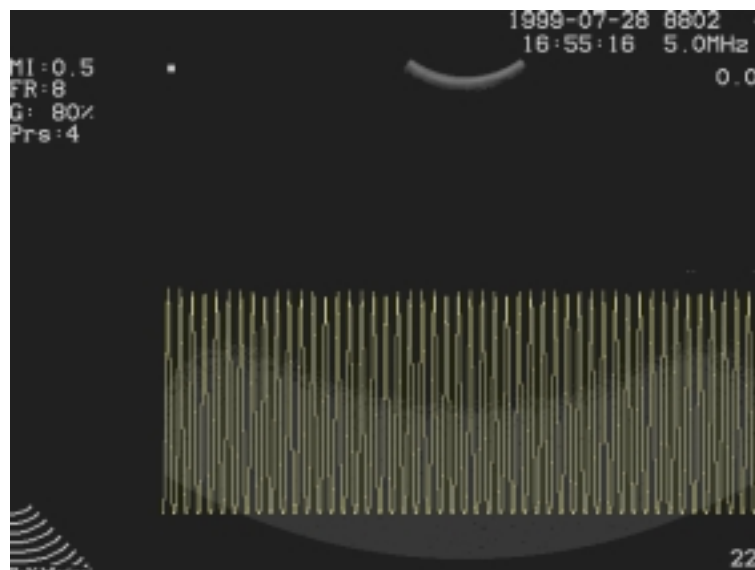



Fig. 3.3-14. ECG Test Oscillator

3.3. Monitor Checking

Press **Shift, Alt, and G**, to get a test picture on the monitor screen (The scanner must be in freeze mode).

1. One for brightness with two dark squares where one is 2/255 and the other is 4/255 of 100% white, Brightness is adjusted so the 2/255 part disappear and the 4/255 is just become visible.
2. One for contrast with one square filled out white 100% white (255/255). Contrast has to be adjusted to 60 cd/m² measured in the centre of the square
3. Test picture displaying a linear 8 step greyscale for final check of monitor adjustment

Use **<Alt><Shift><G>** to toggle through the test pictures.

- 1.
2. Verify that the external controls for Brightness and Contrast (on the monitor) provides sufficient adjustment range and set to give the best image.
3. Press the **Shift, Alt** and . Then press **F5** to chose the Test picture. (Pressing **F5** toggles between Geometric test picture, all pixel off, all pixels on)

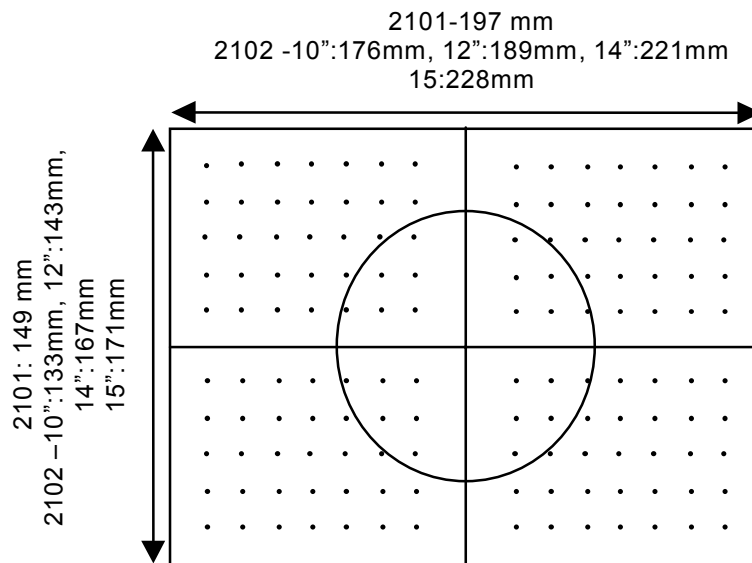



Fig. 3.3-15. *The Geometric Test Picture..*

4. Check the geometry of the test Picture.
5. If you have problems meeting the above requirements, consult Section 5, ADJUSTMENT PROCEDURE.

3.4. Transducer Inputs

1. Move the transducer connector to the other input module(s), Press  and confirm that the transducer can be identified.
2. Start the transducer to verify correct operation of the input module.

Note: If available connect a Single-element transducer to the Single element socket and verify correct operation of the transducer.

3.5. Track Ball

The track ball should move smoothly. If it is too tight or too loose you can adjust it using the adjusting tool QA0228 (mounted underneath the keyboard)

1. Start the scan mode and press 
2. Press **ABC** and check that a white square appears on the monitor screen. Move your finger on the Tracker ball and verify that the square can be set off for a linear movement in any direction within the B-image field.
3. Press **ABC** until the square disappears.

3.6. Gain/TGC



1. Press  to start scanning.
2. Adjust the gain using the gain potentiometer and observe the effects on the B-image.
3. Adjust the TGC curve using the TGC Potentiometers and observe the effect on the B-image.

3.7. Size

1. Verify the function of the  (Image Size): Press Lower Image Size button to decrease the size of the objects (higher scale units) and the upper Image Size button to enlarge the size of the objects (lower scale units).

3.8. Focusing

Note: This section is only valid for array transducers.

1. Check that there is a focus zone mark (arrow) on the screen. (If not press )
2. Move the Tracker Ball up and down and check that the arrow moves accordingly on the monitor screen. Also check that max. lateral (horizontal) resolution is at the position of the arrow - use the phantom, model 254, to check the focusing.
3. Press  again to toggle the number of zones selected (1-4)

3.9. Frame Rate

1. Connect a mechanical transducer and press the Frame Rate Up/Down  and observe that the speed of motor change correspondingly.
2. Connect a Array transducer, press the Frame Rate Up/Down and observe that increased frame rate narrows the scanning field.

3.10. Image Processing

1. Press . Use phantom, model 254, to check the following:
2. Press Contrast **F1**, **F2** and observe the effect on the image.
3. Press Contour **F3** and observe the effect on the image
4. Press Grey Scale **F4**, **F5** and step trough the five different grey scales. Observe the effect on the image





3.11. Persistence

1. Press Persistence Up/Down to change the averaging (0 is no averaging and 5 is max averaging) and check the effect on the image.





3.12. Puncture

1. Press  to select the default puncture guide for the selected transducer, if applicable, and check that puncture dots appear in the B-image field.

3.13. Zoom

1. Press  and check that a white frame appears on the screen. (Dependent on the setting in System Setup the frame will have a zoom or panning function)
2. Check by using the tracker ball that the frame can be moved to any position.
3. Press the  control to adjust the size of the zoom frame.
4. Press the  control to be able to move the zoom frame again if necessary.
5. The scanner will automatically zoom in on the selected area when you have finished resizing and moving the frame.
6. To move or resize the zoom area Press , the image is shown in full size, adjust the frame size and location and the scanner will automatically zoom in on the new area.
7. To turn off the Zoom function, press  for more than 1 second.

3.14. Measure

1. Press  to place a set of distance markers on the monitor. Check that the distance between the markers are read out.
2. Press  to move the other marker.
3. Activate another set of markers by pressing .
4. Check the Area and Volume determination using the Draw- and Ellipse methods (under **Basic**). Press  to start drawing.

3.15. Image review



1. Make a scan and press .
2. Observe that a horizontal Track ball movement scrolls through the most recently recorded B mode images.

3.16. M-mode



Note: This section is only valid for Linear Array and Convex Array.

1. Press the **M** on the keyboard.
2. Start the transducer and check that the echoes now are displayed both as a normal image and as horizontal lines that reflect the echo information along the M-mode line.

3.17. Split Screen







1. Press  to activate Split Screen.
2. Press **A** to make a scan "A"
3. Press  and repeat for "B"

3.18. Image Storage



1. Insert a formatted floppy disk in the floppy drive.
2. Freeze the image on the screen.
3. Press  to store the current monitor display on a floppy disk.
4. Press  and press **F5** to see the list of images on the floppy disk and press  to retrieve the image.

3.19. Audio/Spectral Doppler (only 2102)

Note: This section is only valid for Array transducers.

1. Press Duplex and place the sample volume over a vessel.
2. Observe that sound can be heard in the speaker and a Doppler spectrum is shown.
3. **Audio Volume** - press  and check that the volume of the audio signal can be adjusted.
4. **Gain** - use the smaller topmost Gain Control and adjust the gain up and down. Observe that spectrum noise and sound changes.
5. Filter changes the setting of the wall filter. Observe that the low frequency components close to the base-line disappears.
6. **Range** – press  and observe that the resolution of the spectrum decreases when the range is increased.
7. **Baseline** - press  up/down and check that the spectrum is offset.
8. **Doppler Sample Volume** - Press  to change the size of the sample volume, using the trackball. Use select () to toggle between resizing and moving the sample value.
9. **Doppler Angle** – press  and adjust the angle of the sample volume with the trackball. Check that the scale is changed.
10. **Steered Doppler** –press  to angle the Doppler beam. Press steered to toggle between left angling, right angling and no angling.
Note: Steered Doppler cannot be selected, if not supported by the transducer.

3.20. CFM (only 2102)

1. Press the **CFM** control.
2. Unfreeze and place the transducer over a vessel. Move the colour box using the Track ball and verify flow in the colour box.
3. **Gain** - Increase CFM gain using the smaller topmost Gain Control and observe that the colour box is filled with coloured noise dots.
4. **Base line** - move the base line up and down with the base line control . Check that the colour scale is offset allowing to measure a larger range of velocities in one direction.
5. **Colour resolution**- press the resolution control . Increase the resolution and check that the number of lines in the CFM image is increased and framerate is decreased.
6. **Colour persist** - press  up/down to control the colour persistence level. Check that increased persistence slows down the update of the colours.

3.21. PIP (only for 2102 with the PIP option)

1. Connect an external video signal to either Composite, S-VHS or RGBS.
2. Press **Setup, F2, F4** to configure the PIP parameters (video source).
3. Press  on the Palm Control Unit to toggle through the following options: Ultrasound image only, Picture In Picture mode, External Video only.



Fig 3.2-1 Example of a Picture In Picture image

3.22. 3D system (6503 option)

3.22.1. Basic check – start up & signal transfer to/from scanner

1. Connect a transducer that is supported by the 3D system.
2. Turn on the scanner and wait for it to complete boot up. The integrated 3D option has completed boot-up when a sound sequence (♫) is heard.
3. Press **ID** and enter “patient name + ID number” e.g. “TEST 0123”. Press Enter.
4. Press “3D (F)” and check that the system switch to 3D mode.
5. Check that the Last name and ID has been transferred to the 3D database entry view and click on *OK*



6. Click on the Acquisition icon and check that the ultrasound image can be seen in the acquisition window.
7. Check that the ultrasound image in the acquisition window is updated e.g. check that the clock is running or scan with the transducer.
8. Press the right footswitch and check that the system switches to 2D. Press the switch again to get back to 3D.

3.22.2. Acquisition

9. Click on the *Preset* icon and select an untracked scan from the list.
10. Place the transducer on a phantom or on yourself.



11. Click on the “*Start Scan*” or press the left footswitch to start an acquisition.
12. Move the transducer slowly and check the a number which counts down is displayed in the upper right corner.



13. When the acquisition has been completed click on the 3D cube.
14. Check that the cube has been filled with echo information from the transducer and that the cube can be rotated and manipulated with



15. Save the scan.

3.22.3. CD-RW drive

16. Insert a CD in the CD ROM drive. If the CD is blank it needs to be formatted first- refer to the user guide.

17. Click on Patient Database mode.



18. Select the scan that you have just saved.

19. Click on File

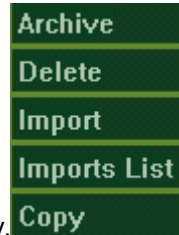

20. Click on Ok at the dialog informing about the time it will take and click on OK when the copying is completed.

21. Click on File

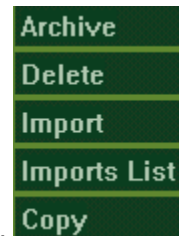

22. Check that the volume has been saved on the CD.
23. Select the volume and click on View.
24. Check that the volume can be read from the CD.

3.22.4. ECRM option

1. Connect the ECRM (EndoCavity Rotational Mover) to the 3D system
2. Connect the 8658 to the scanner and select it as the active transducer (S section).
3. Place the transducer in the cradle



4. Switch to 3D mode and select Acquisition mode
5. Select "8658 /S Motorised Fan" as preset.
6. Check that the angle is 90 degrees – if not change it to 90 degrees
7. Click on the "start scan" button on the ECRM
8. Check that the ECRM rotates and that it stops after 90 degrees.



9. Press "3D view" on the ECRM and check that it switch to 3D mode.



10. Click on the Acquisition icon.
11. Press "Clear Scan" on the ECRM and check that the "Save scan" and "Clear Scan" icons disappears.
12. Press "Start Scan" and then press the "Emergency stop" and check that the ECRM stops rotating.

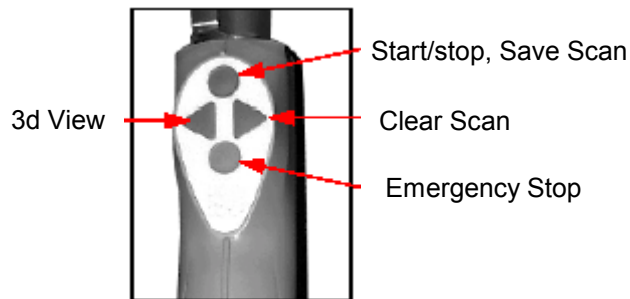

3.22.5. Pull back option

1. Connect the Pull back to the 3D system
2. Connect the 1850 transducer to the scanner and select 6004 as the active transducer.
3. Place the transducer in the cradle



4. Switch to 3D mode and select Acquisition mode
5. Select "1850-6004 Motorized Pullback" as preset
6. Note the distance that it is set for
7. Check that the start position is aligned to zero



8. Start the acquisition and check that the pull back moves and stops after the distance set.

3.22.6. 2050 3D scanning

1. Connect the 2050 splitter adapter to the scanner and connect the splitter adapter to the 3D system (MCM connector).
2. Connect the 2050 transducer to the scanner and select it as the active transducer on the scanner



3. Switch to 3D mode and select Acquisition mode
4. Select "2050" as preset
5. Set the distance to maximum - 6 cm.
6. Start scanning with the crystal positioned at the 2050 tip (default position)
7. Place the transducer (crystal) at the top position of the phantom.
8. Look at the distance markers at the transducer and lower the transducer 6 cm (the same distance as the acquisition has been set for).



9. Start the acquisition and check that the transducer pulls back the crystal and stops after 6 cm (the top of the phantom).

3.22.7. MTF (Magnetic Tracked Freehand) option

1. Connect the MTF to the 3D system
2. Connect a transducer which is supported by MTF and select it as the active transducer.
3. Place the transmitter in the holder and attach it to the transducer
4. Switch to 3D mode and select Acquisition mode
5. Select a Linear or Curvilinear preset
6. Position a plastic ruler on the patient table approximately 40 cm from the transmitter. Perform the scan by dragging the probe perpendicular to the imaging plane, with the probe tip running along the edge of the plastic ruler, see below.

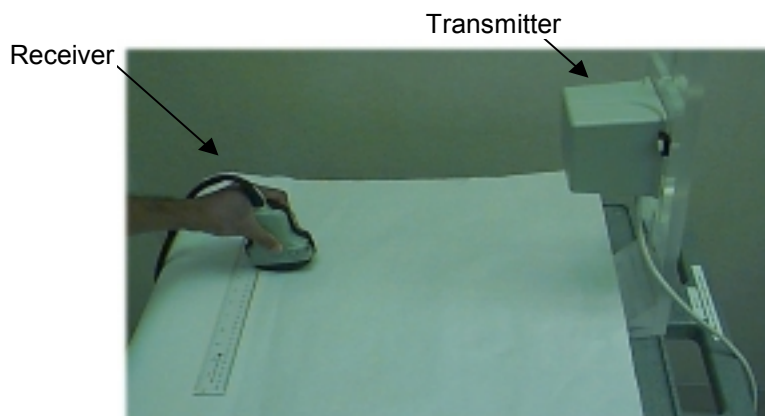

7. The total scan extent should be approximately 7 cm for high-frequency probes (e.g., 8664), and approximately 10cm for low-frequency probes (e.g., 8665). Verify that the reconstructed image cut along a reconstructed plane shows the probe tip as having followed a straight line (see picture below).

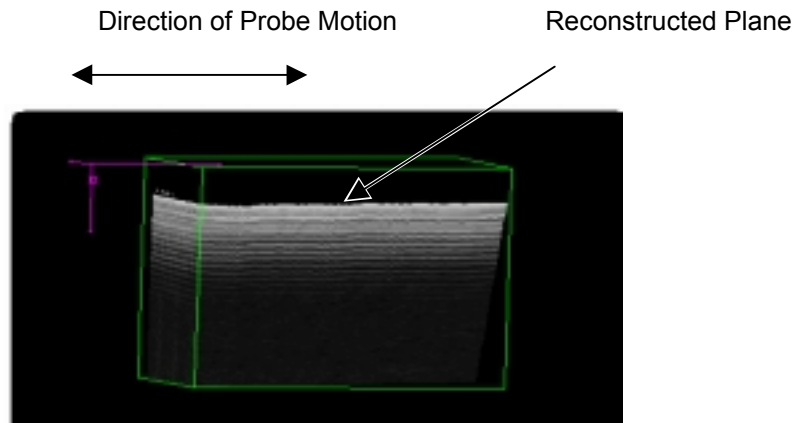

8. Use the distance-measuring tool  to place a line along the probe tip in the reconstructed dimension. The endpoints of the tool line should lie on the probe tip image at approximately 10% from the ends. (The reconstructed dimension is the dimension along which the probe was moved). The maximum deviation of any point on the line formed by the probe tip from the measuring tool line should be less than or equal to 0.2cm. The probe tip line should be smooth, with a peak to peak amplitude of the jitter less than or equal to 0.1cm.

Section 4

TROUBLESHOOTING

CONTENTS	PAGE
4.1. Introduction.....	2
4.2. Replaceable Parts.....	2
4.3. Keys to Troubleshoot Specific Problems (Hints)	2
4.3.1. Boot Problem - Scanner	3
4.3.2. Loss of user set-up.....	3
4.3.3. Transducer or scanner	4
4.3.4. No Echo Information.....	4
4.4. The Test Oscillators	5
4.4.1. Location of The Test Oscillators	5
4.4.2. The Scancon Test Oscillators.....	6
4.4.3. The Delay Test Oscillator	7
4.4.4. The Input Test Oscillator	10
4.4.5. The Doppler Test Oscillator (only 2102).....	11
4.4.6. The Single Input Test Oscillator	12
4.4.7. The ECG Test Oscillator.....	13
4.4.8. Monitor Tests.....	13
4.5. Power Supply.....	14
4.5.1. Troubleshooting the Power Supply.....	14
4.5.2. The Voltage LED's.....	14
4.5.3. Block Diagram of the Power Supply	14
4.6. Monitor ZV0049/ZV0050/ZV0060/ZV0065	16
4.6.1. Monitor Disassembling	16
4.6.2. Missing picture on monitor.....	16
4.7. Test of the 2102 Docking cable (UA1278).....	17
4.8. Software update (on the scanner).....	18
4.8.1. User setup.	18
4.8.2. Loading main software	18
4.9. Error Log on Core Board	20
4.10. Trouble shooting the PC Back-end (3D system).....	21
4.10.1. Cannot switch to 3D system – boot problem	21
4.10.2. Problems with CD-ROM drive.....	21
4.10.3. Mover problems	22
4.10.4. Problem opening the database.....	22
4.10.5. 3D trackball does not work	22
4.11. 3D Service mode.....	23
4.12. 3D disk structure	25
4.13. MCMComm.....	27
4.14. 3D software upgrade	29

4.1. Introduction

This section is divided into separate subsections some of which cover specific areas within the troubleshooting, others describe the overall test facilities in the 2101/2102.

But before you jump to any of the subsections you should first consult Section 4.3 which might give you, if not the solution, then some ideas of how to troubleshoot this particular problem of yours.

To prevent injury to persons and damage to the 2101/2102 be aware of the following:

WARNINGS:

- Opening the Power Supply can expose live parts.
- Any work done on the open instrument with power On must only be done by B-K Medical or their authorized representatives, who are aware of the hazards involved.
- Any repair work done on the 2101/2102 system must be followed by an electrical safety test to verify a continuous safe operation of the system.
- The Core board contains a lithium battery. The battery must only be replaced by a person having special knowledge as described in sec. 4.2 Replaceable Parts

CAUTIONS:

- Switch Off the 2101/2102 before connecting or disconnecting the 2101/2102 to any peripheral units. Failure to do so could damage the equipment.
- The PC Boards in the 2101/2102 are sensitive for static discharge. Therefore, when handling PC Boards always take steps to prevent static discharge - see Section 1.5, Special Tools and Equipment.

4.2. Replaceable Parts

Apart from a few exceptions listed below all PC Boards and modules in 2101/2102 can be replaced without further actions made. Any work that requires opening the 2101/2102 must however be followed by an electrical safety test.

Before replacing a subassembly it is necessary to verify that the ID (revision) of the new part is the same or higher than the ID of the defective part.

Item to be replaced:	Type of unit effected:	<u>Necessary action after replacement:</u>
ZV0049 Monitor	2101 only	Monitor Adjustment - Section 5
ZG0341 PWR Supply	2101 only	Monitor Adjustment - Section 5
QB0041 Lithium battery	All	Set real time clock + User settings
ZH0743 Video Mixer Board	EXL	Enable PIP if replaced board had this enabled - Section 4
ZD0753/62/67/71 Core Board	All	Set real time clock + User settings
UL0023 Harddisk	EXL	Restore Patient database and User settings for the 3D system – Section 4

4.3. Keys to Troubleshoot Specific Problems (Hints)

4.3.1. Boot Problem - Scanner

Possible cause	Look for	Actions to locate failure
Defective Power Supply	Green LED inside power supply	Check the Power Supply – sec. 4.5.1
Dip Switch #8 set to Debug terminal	Only the first line in the boot sequence is displayed	Check dip switch #8 – sec. 9.5
Defective Core board	After “switching task” in the boot sequence the scanner stops (breaks down).	Check error log – sec. 4.9
Defective Core board	The count up in the boot sequence is never completed to “switching task”	Try to reload the software
Defective Keyboard	The message : “Keyboard error ! “ is displayed during boot up	Check the keyboard connection if OK try another keyboard Note: Any keyboard from 1101/2101/2102 can be used for this test
Board is pulling down Power Supply or preventing Core board to complete boot sequence		Successively disconnect the Front-end, Delay, Doppler and Single module until the unit can boot. Remember to switch off the 2101/2102 before the boards are removed

The boot sequence should under normal circumstances look like below. The first line: “Type 2100 LOADER VP2767 (CB2100) 10-26-2001 08:48:14” appears when the system is starting in the boot-prom. Then it starts loading the main software from the Flash-prom into the RAM, this is indicated with a number (Byte) counting up. As the last sequence the task is changed to the main software – “switching task”.

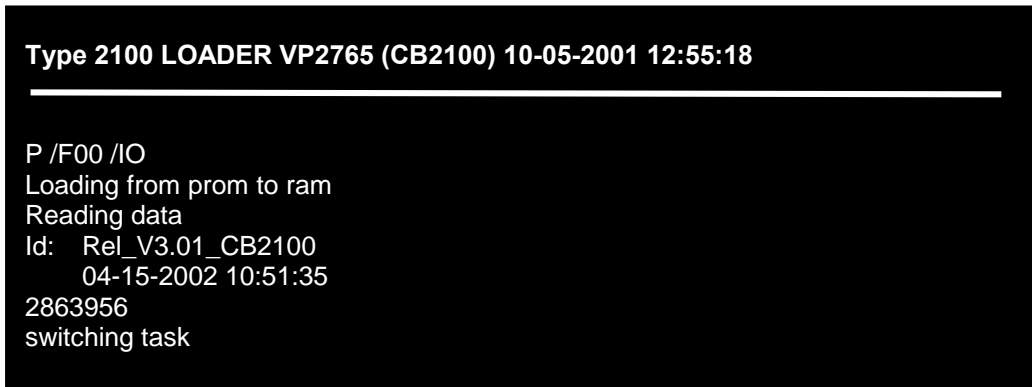

```

Type 2100 LOADER VP2765 (CB2100) 10-05-2001 12:55:18
-----
P /F00 /IO
Loading from prom to ram
Reading data
Id: Rel_V3.01_CB2100
    04-15-2002 10:51:35
2863956
switching task

```

Fig. 4.3-1. Booting sequence on the monitor screen

4.3.2. Loss of user set-up

Check the lithium battery on the Core board (also check for bad contact)

4.3.3. Transducer or scanner

- First of all: Try another transducer!
- Try the other Array Input Connector
- If possible, connect a single-element transducer to bypass the Front-end board and part of the Delay board.

Radial or Vertical lines

The problem is most likely caused by the Analogue Front End, Delay, or the transducer. Use the Test Oscillators to isolate the fault. (**Shift, Alt** and )

Concentric rings or Horizontal bands

If concentric rings or horizontal bands are visible in the B-image the Delay or Front-end board should be suspected. Use the Test Oscillators to isolate the fault. (**Shift, Alt** and )

Noise pattern in the B-image

A noise pattern in the **far field** is often caused by external noise entering the scanner trough the air or via the mains cable. To isolate the problem check/try the following:

- Connect the scanner to another mains outlet, preferably in another room. A change in the noise pattern indicates noise on the mains.
- Check that the wall outlet has a proper grounding.
- Compare different transducer types and frequencies (MFI). External noise is often frequency specific.

The noise can also be caused by a failure in the digital noise reduction system on the Delay board. Use the test oscillators to confirm this. (**Shift, Alt** and )

Note:

Before contacting the support group in Denmark for help with noise problems it is recommended that you try out the suggestions above. Use the image storage facility of the 2101/2102 to save a couple of images showing the problems. The images can be attached to an e-mail.

4.3.4. No Echo Information

Possible cause	Look for	Actions to locate failure
Defective transducer		Try another transducer
Defective Front End board - recognise circuit	Transducer type no. on the monitor	Try another transducer and/or try the delay/single module test which simulates the transducer codes
Defective keyboard ( key)	Does * symbol disappear when unfreezing	Try on the scanner keyboard and on the transducer as well
Missing HV on Power Supply	Green HV-LED inside power supply	Check the Power Supply – sec. 4.5
Failure on Front-end board - receive part		Check input test osc. – sec. 4.4.4
Failure on Front-end board – transmit part		Try with a single module transducer if possible
Failure on Delay board		Check delay test osc. – sec. 4.4.3
Defective Core board -Scan Converter part		Check scancon test osc - sec 4.4.2
Defective Core board – HV setup to Power Supply	Green HV-LED inside power supply	Check the Power Supply – sec. 4.5
Defective Core board – RTSC part		Try with another Core board

4.4. The Test Oscillators

The 2101/2102 is equipped with a number of Test Oscillators for troubleshooting purposes.

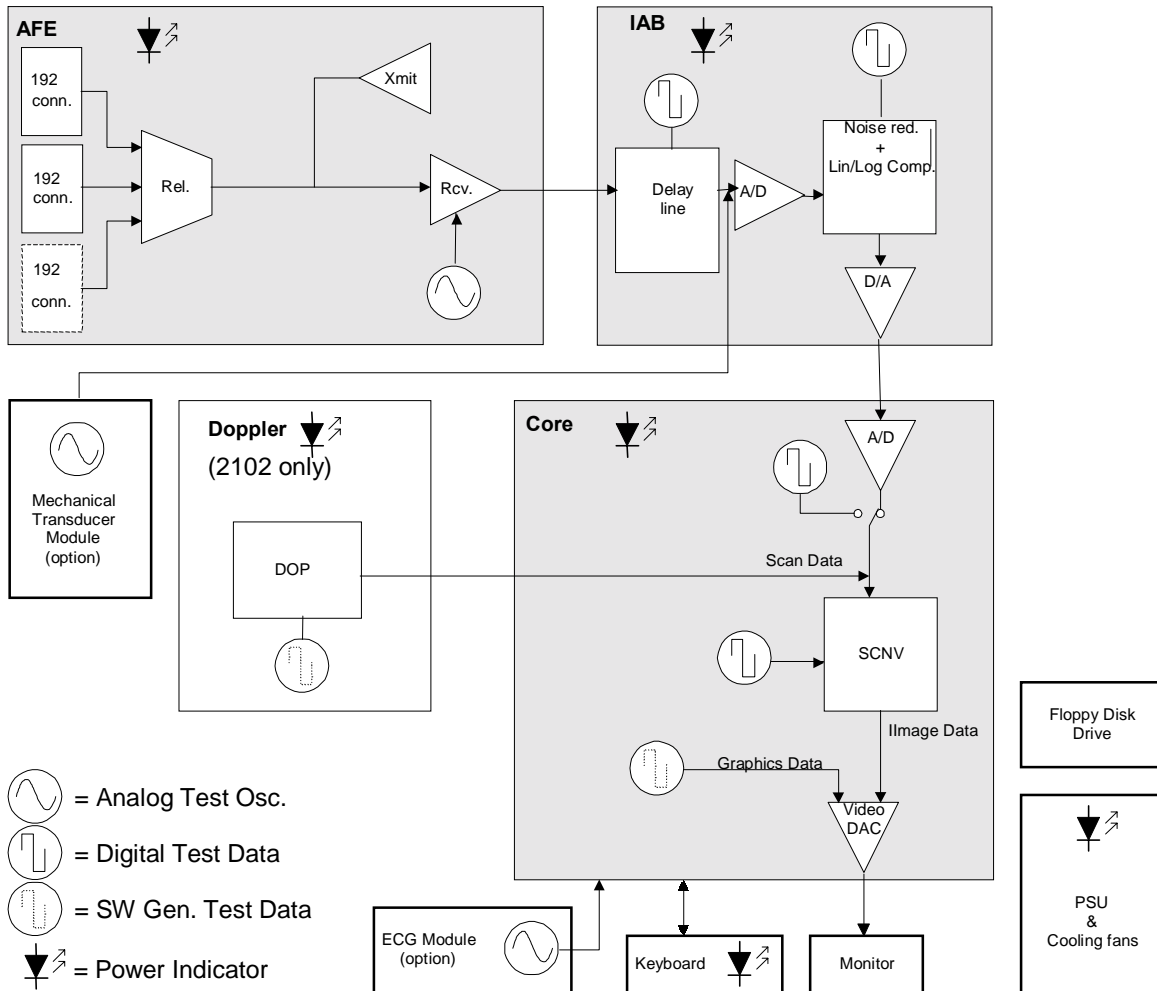

Fig. 4-4-1. Oscillator Signal Flow

4.4.1. Location of The Test Oscillators

Refer to Fig. 4.4-1 for the location of the oscillators.

The Test Oscillator menu are activated by pressing **Shift, Alt** and

The Single Transducer and ECG test oscillator are activated by pressing **Shift, Alt, Z** and **Shift, Alt, S** respectively.

4.4.2. The Scancon Test Oscillators

An array transducer must be connected and active to start this oscillator.
 Press F3 Scancon osc to toggle between Scancon test 1,2 and 3.

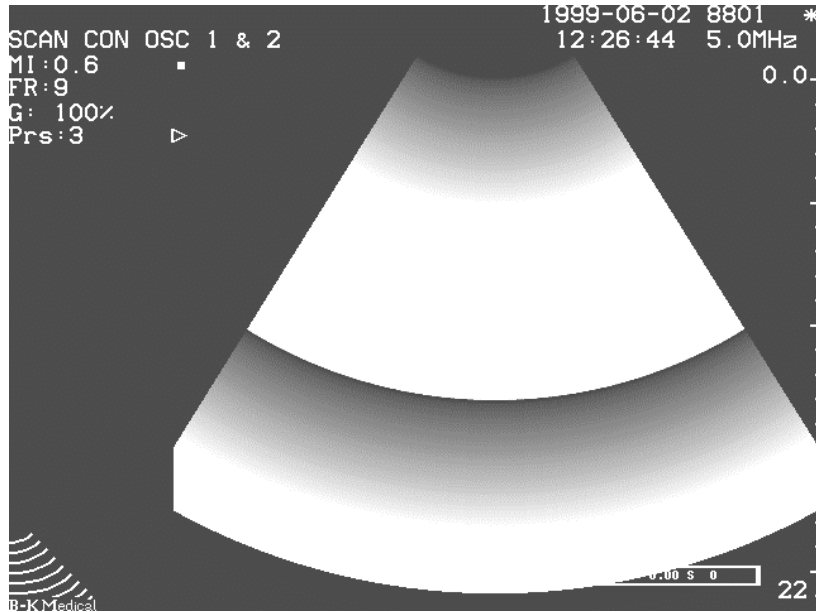

Fig. 4.4- 2. Scancon Test Oscillator 1 and 2

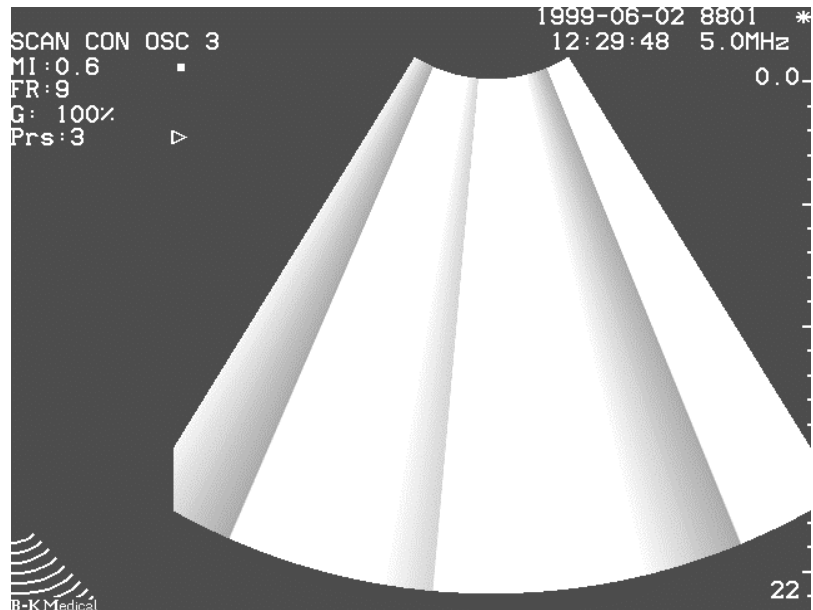



Fig. 4.4- 3. Scancon Test Oscillator 3.

Note ! This image might flicker dependable of transducer type and size.

4.4.3. The Delay Test Oscillator

Power off, disconnect all transducers and power on the 2101/2102. Press **Shift, Alt** and  and then press **F2**, Delay Test to toggle between Delay osc. 1,2 and 3.

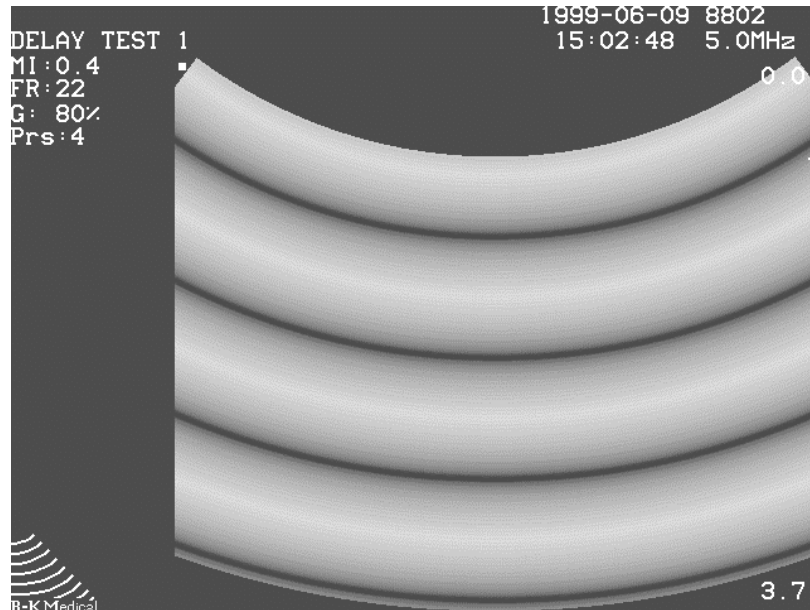

Fig. 4.4- 4. Delay Test Oscillator 1.

The DELAY TEST 1 is a verification of the digital noise reduction. It is controlled that data can be written to the noise reduction frames and that the signal compression is functioning. The image consist of concentric bands which gradually goes from black to white (light grey) and then back to black.
Pre-requisite: The Scancon Test must pass.

DELAY TEST 2 is a verification that all 48/64 channels from the Front End board to the Delay board are active (Test osc. Located on the FE board). 6/8 circular bands are shown, one for each delay component. Each of the rectangles consist of 16 narrow bands. One for each Tap Driver. Note ! If changing size after the test is activated you may only see some of the 6/8 bands.
 Pre-requisite: Input Test Oscillator and Delay Test 1 must pass

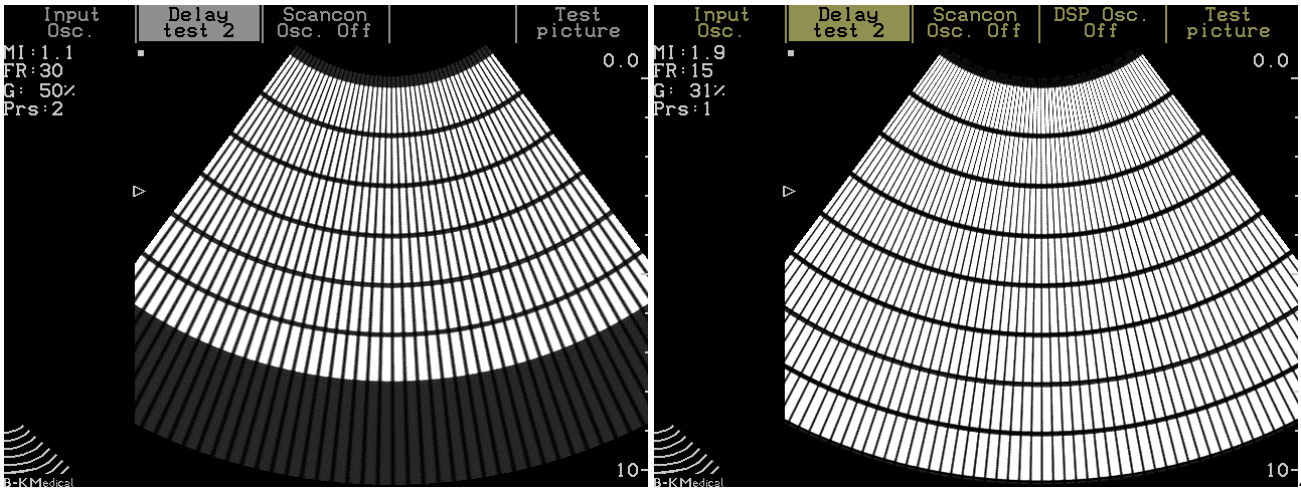

Fig. 4.4- 5. Delay Test Oscillator 2 – 2101(left side) and 2102 (right side).

If one or more lines are missing it can be either the channel(s) on the Front-end, the cable between the Front-end and Delay board, or the channel(s) on the Delay board itself that is defective. To isolate the fault try to reroute the signals from the output on the Front-end board to the input on the Delay board manually. An output can be connected to any input.

Note that the Input Test Oscillator (on the Front-end board) is used to generate the white level for the Delay Test thus the input Test Oscillator must pass its test also.

To test part of the TGC control it is recommended to turn the gain down to see if all bands can be adjusted to dark gray and turn the gain up again to see if all bands appears white again.

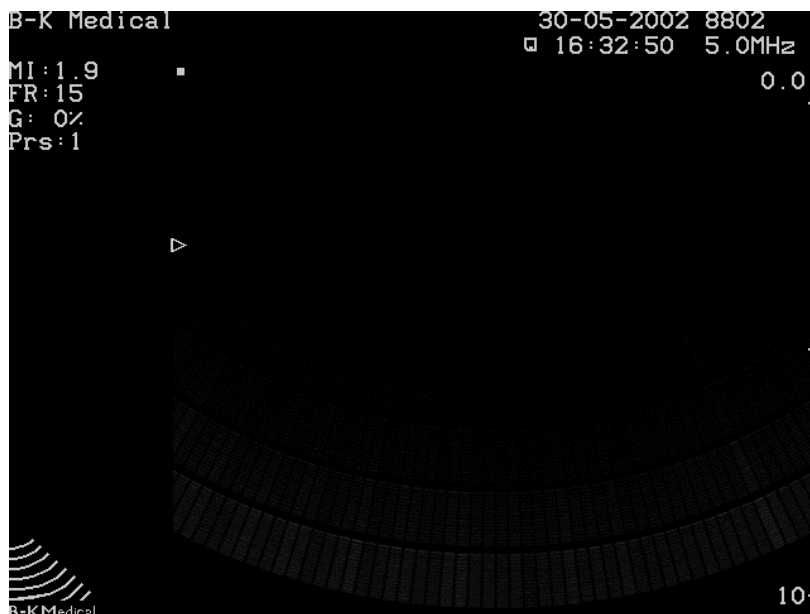

Fig. 4.4- 6. Delay Test Oscillator 2 – with gain turned down

DELAY TEST 3 is a verification that all 24/32 inputs on the beamformer works, including aperture opening and dynamic focusing. The 24/32 radial fields separated by narrow white lines. The fields should be white from top to bottom and then gradual decrease in length going from right to left.

Note ! On 2101 the left line should be a narrow line where as on the 2102 it should be a wide field.

Pre-requisite: Input Test Oscillator, Delay Test 1 and Delay Test 2 must pass.

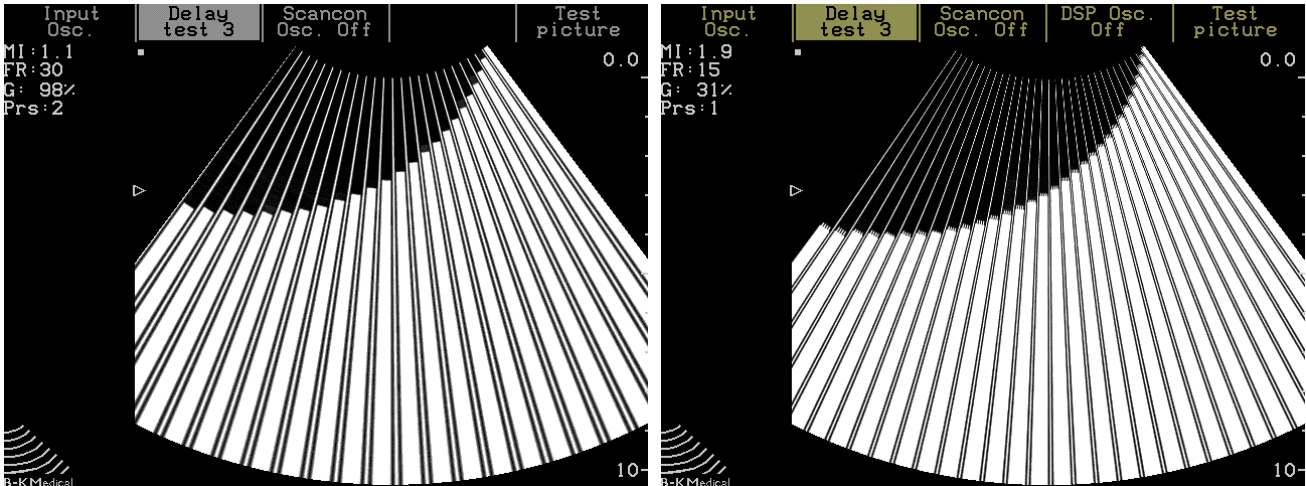

Fig. 4.4- 7. Delay Test Oscillator 3 - 2101(left side) and 2102 (right side).

Note that the Input Test Oscillator (on the Front-end board) is used to generate the white level for the Delay Test thus the input Test Oscillator must pass its test also.

To test part of the TGC control it is recommended to turn the gain down to see if all bands can be adjusted to dark gray and turn the gain up again to see if all bands appears white again.

4.4.4. The Input Test Oscillator

An array transducer must be connected and active to start this oscillator. Press **F1** to select the Input Test Oscillator.

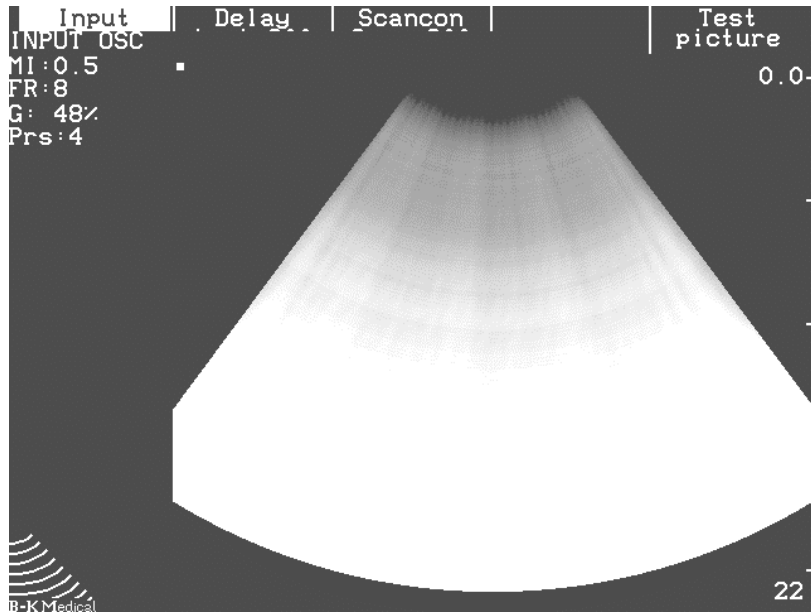



Fig. 4.4- 8. Input Test Oscillator.

4.4.5. The Doppler Test Oscillator (only 2102)

An array transducer must be connected and active to start this oscillator. Press **CFM** to switch to Doppler mode. Press **Shift, Alt** and  and then press **F4**, DSP Test to activate the oscillator. Freeze and unfreeze the image.

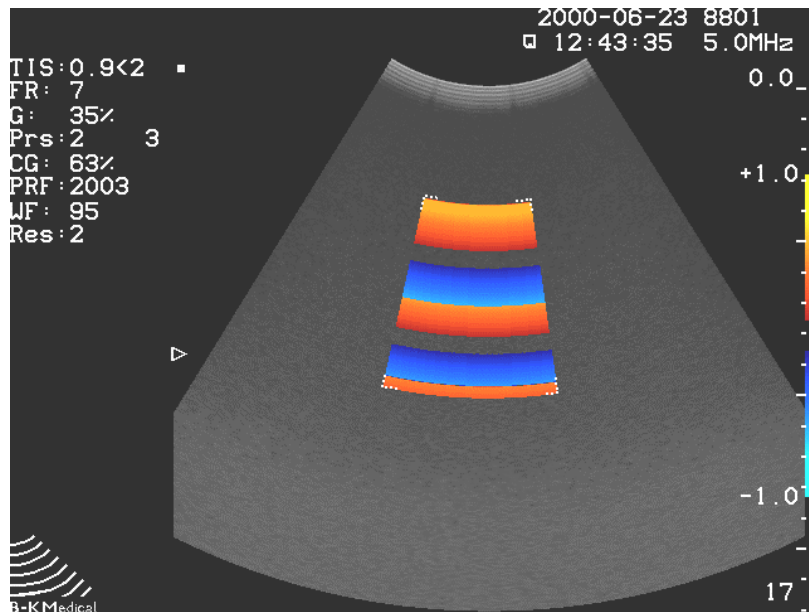



Fig. 4.4- 9. Doppler test Oscillator 1.

Press **Shift, Alt** and  to activate the Test menu and then press **F4** to activate Test oscillator Disp. Osc.2 Press **Freeze** twice (freeze and then unfreeze).

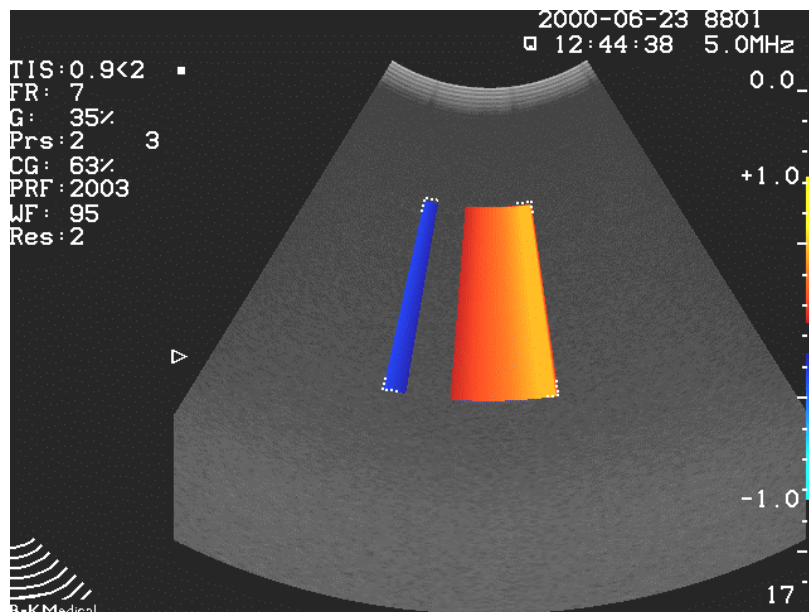



Fig. 4.4- 10. Doppler test Oscillator 2.

4.4.6. The Single Input Test Oscillator

Single Input Test oscillator (optional)

Disconnect the transducer before activating the Single Input Test oscillator by pressing **Shift -Alt-Z**. Then select the single element simulator that you want to activate e.g. 8539

– used with 1850 - (F2) and press .

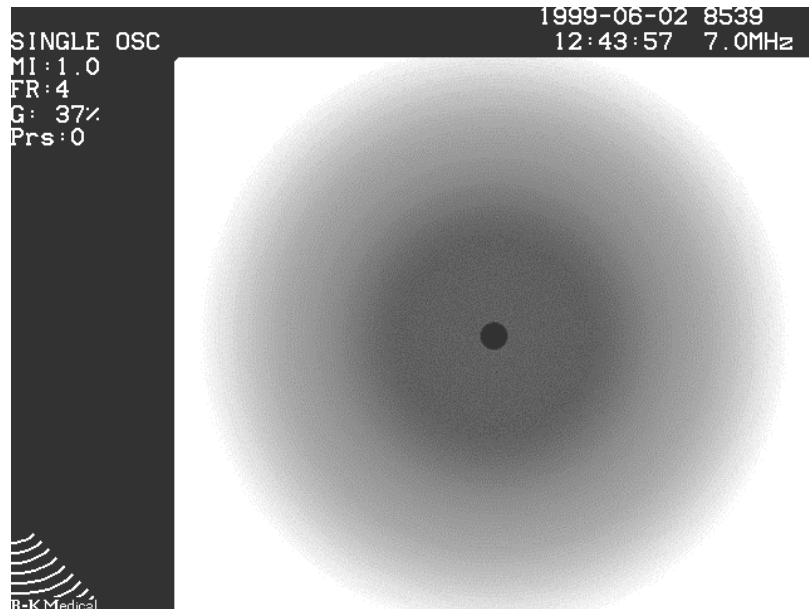

Fig. 4.4- 11. Single Input Test Oscillator.

4.4.7. The ECG Test Oscillator

ECG Test oscillator(optional)

Connect a transducer and start scanning. Then select ECG curve by pressing **S** (HR). Finally select the ECG test by pressing **Shift-Alt-S**.

Note ! The amplitude and position of test curve depends of the setting of the ECG potentiometers.

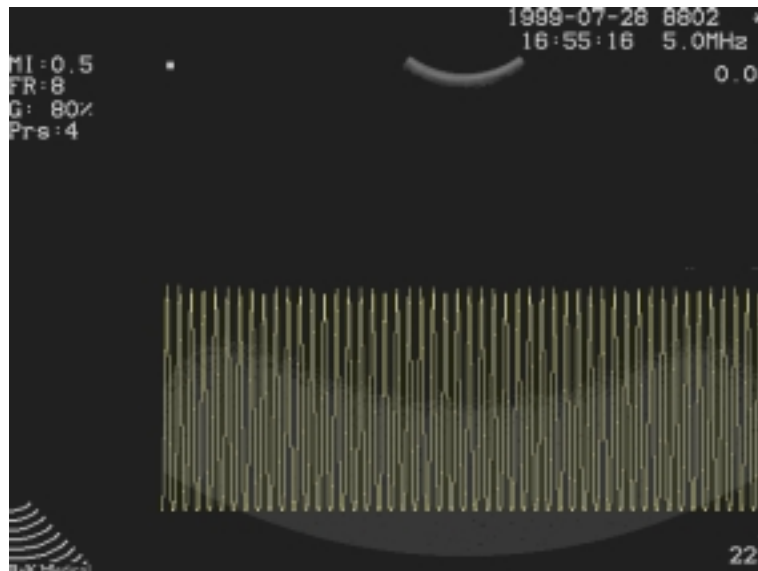



Fig. 4.4- 12. ECG Test Oscillator.

4.4.8. Monitor Tests

The monitor tests are used during checking and adjustment of the monitor.

To start the Test osc. Press **Shift, Alt** and . Press **F5** to toggle between the three test pictures.

1. Geometric Test picture for testing linearity, phase and size.
2. All pixels off.
3. All pixels on.

(See Section 5, MONITOR ADJUSTMENT PROCEDURE.)

4.5. Power Supply

4.5.1. Troubleshooting the Power Supply

The 2101/2102 Power Supply is replaced as a complete unit.

WARNING: Mains voltage is present in the Power Supply.

4.5.2. The Voltage LED's

Inside the Power Supply are two green Voltage LED's which are visible through one hole at the rear side of the power supply (when the back cover of the 2101/2102 has been removed).

When the Power Supply is working satisfactorily, i.e. all voltages are present, the right hand Green Voltage LEDs will be lit. The left hand LED which represents the High Voltage (+/- HV) is only present during scanning. (After freezing the image the LED will be lit for approximate half a minute) Refer to Fig. 4.5-1.

The Power Supply type ZG0348 which has the soft power down function has also a green LED at the front which lights as long as mains power is present on the optional PC Back-end module.

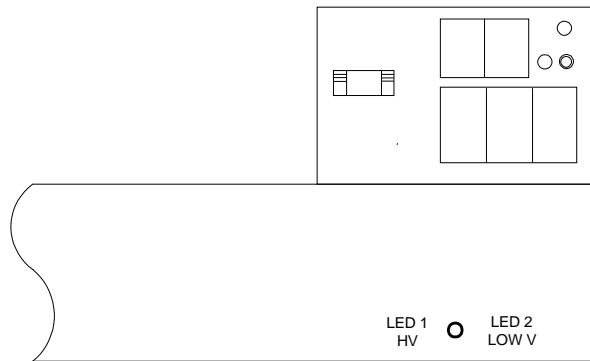

Fig. 4.5- 1. Voltage LED's.

4.5.3. Block Diagram of the Power Supply

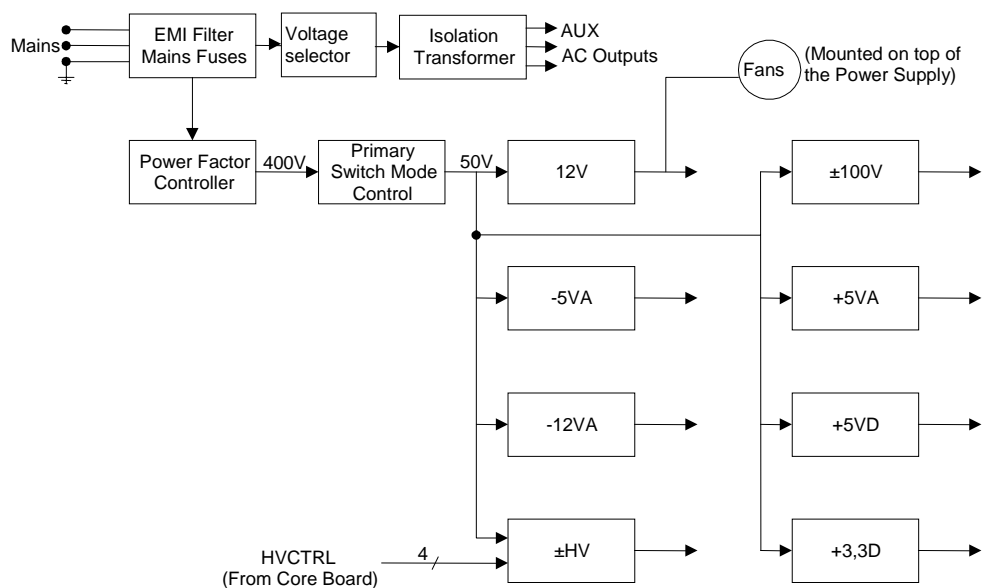

Fig. 4.5- 2. Power Supply ZG0341/348

If one or both of the Voltage LEDs are Off it indicates that one or more voltages are Missing. The reason is one of three:

- (1) A defective transducer shorting the HV
- (2) A short-circuit in the Console,
- (3) A Power Supply fault

What to do:

Try another transducer.

Switch off and disconnect the keyboard and the monitor . Switch on and observe the status of the LED's. If the LED 2 (low voltage) are on the keyboard or the monitor may be defective .

"Search for the short-circuit in the Console" is done by successively lifting up the boards. Remember to switch off the 2101/2102 before the boards are removed. The scanner should be able to boot with all boards except for Core board and Power supply removed.

The power supply itself is checked by removing the supply from the cassette and measuring the voltages on the power supply plug. Refer to Fig 4.5-3

Note:

The measured voltages does not reflect the tolerances from Fig 4.5-5 as these are the values when the supply is loaded.

The Power Supply HV output can not operate with the power plug disconnected from the motherboard. By short circuiting pin 4 and pin 14 on the power supply plug the green HV-LED on the power supply should be on and from +68 to +76 Volts should be present at pin 12 (Ref. pin 10) and from -68 to -76 Volts should be present at pin 24 (Ref pin 10).

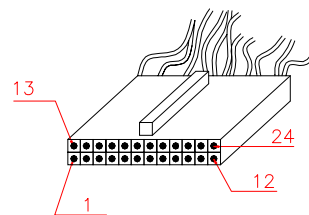

Fig. 4.5-3. PWR supply plug

1	HVCTRL0	13	HVCTRL1
2	HVCTRL2	14	HVCTRL3
3	+3.3VD	15	DGND
4	+5VD	16	DGND
5	+5VD	17	DGND
6	+5VA	18	AGND
7	-5VA	19	AGND
8	+12VA	20	AGND
9	-12VA	21	AGND
10	AGND	22	AGND
11	+100VA	23	-100VA
12	+HV	24	-HV

Fig. 4.5-4. Pin connections

DC OUT-PUT	MAX CURRENT	REGULATION
+3,3VD	2.5A	±5%
+5VD	7A	±2%
+5VA	1.5A	±5%
-5VA	1.5A	±5%
+12VA	5A	±5%
-12VA	4A	±5%
+100VA	50mA	±5%
-100VA	50mA	±5%
+HV	0.35A	±5%
-HV	0.35A	±5%

Fig 4.5-5. Table of voltage tolerances with load

4.6. Monitor ZV0049/ZV0050/ZV0060/ZV0065

The 2101/2102 is equipped with a 12" B/W - / 10"/12"/14" or 15" Colour Monitor.

4.6.1. Monitor Disassembling

To get access to the PCB remove the 4 screws from the rear of the monitor cabinet and remove the monitor cover. (See Section 6.1.5 Getting Access to the Interior of the Monitor for Adjustment.)

4.6.2. Missing picture on monitor

What to do:

- Check the power to the monitor.
- Check that the HV is present. The HV build up can typically be heard during power on.
- Check cables/connectors.
- Try to connect an external monitor.
- If the picture is not present on the external monitor the problem is most likely located on the Core/Video Converter board.
- If the picture is present on the external monitor the problem is most likely located in the monitor or caused by a broken monitor cable.

4.7. Test of the 2102 Docking cable (UA1278)

Locate failures in the cable/box using an ohmmeter.

Cable 1:	Signal	Pin no.	Cable 2:	Signal	Pin no.
RGB Out:	Blue signal	48	RGB In:	Blue signal	44
RGB Out:	Blue Shield	32	RGB In:	Blue Shield	28
RGB Out:	Green Signal	47	RGB In:	Green Signal	43
RGB Out:	Green Shield	31	RGB In:	Green Shield	27
RGB Out:	Red Signal	46	RGB In:	Red Signal	10
RGB Out:	Red Shield	30	RGB In:	Red Shield	26
RGB Out:	Sync (White)	15	RGB In:	Sync (White)	11
RGB Out:	Brown	Cut off	RGB In:	Brown	Cut off
RGB Out:	Yellow	Cut off	RGB In:	Yellow	Cut off
RGB Out:	Black	Cut off	RGB In:	Black	Cut off

Cable 3:	Signal	Pin no.	Cable 4:	Signal	Pin no.
CVBS Out:	Signal	41	CVBS In:	Signal	40
CVBS Out:	Shield	25	CVBS In:	Shield	24

Cable 5:	Signal	Pin no.	Cable 6:	Signal	Pin no.
S-VHS Out:	White	6	S-VHS In:	White	4
S-VHS Out:	White shield	7	S-VHS In:	White shield	5
S-VHS Out:	Brown	38	S-VHS In:	Brown	36
S-VHS Out:	Brown Shield	37	S-VHS In:	Brown Shield	35

Cable 8:	Signal	Pin no.	Cable 7:	Signal	Pin no.
Audio Out:	Signal(white)	34	Audio In:	Signal(Red)	2
Audio Out:	Shield	1	Audio In:	Shield	18

Connector	Signal Name	Docking BOX	Docking Cable
RGBS OUT (1)	Blue Sync Green Red Ground	Pin 3 Pin 13 Pin 2 Pin 1 Shield	Pin 12 Pin 15 Pin 4 Pin 11 Shield
RGBS IN (2)	Blue Sync Green Red Ground	Pin 3 Pin 13 Pin 2 Pin 1 Shield	Pin 3 Pin 13 Pin 2 Pin 1 Shield
CVBS OUT (3)	CVBS Signal Ground	Mid Pin Shield	Mid Pin Shield
CVBS IN (4)	CVBS Signal Ground	Mid Pin Shield	Mid Pin Shield
S-VHS OUT (5)	Y Signal C Signal Ground	Pin 3 Pin 4 Shield	Pin 3 Pin 4 Shield
S-VHS IN (6)	Y Signal C Signal Ground	Pin 3 Pin 4 Shield	Pin 3 Pin 4 Shield
AUDIO IN (7)	Audio Signal Audio ground	Mid Pin Shield	Mid Pin Shield
AUDIO OUT (8)	Audio Signal Audio ground	Mid Pin Shield	Mid Pin Shield

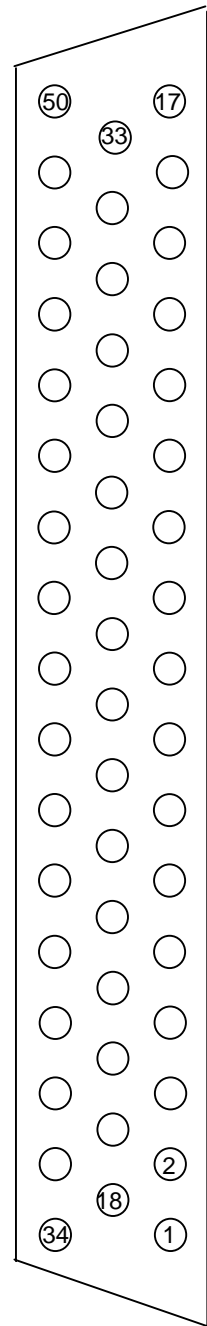
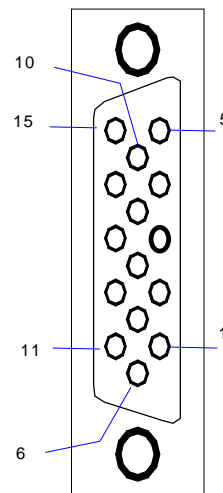

S-VHS pin numbers
On the box

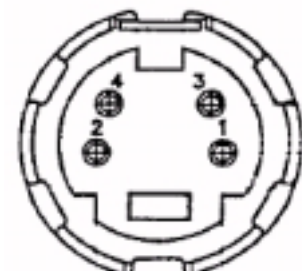

4.8. Software update (on the scanner)

The software for the 2101/2102 can be updated via the build-in floppy disk drive. The files containing the main software on the floppy disks are named: *load.000*, *load.001*, *load.002*, and *load.003*.

4.8.1. User setup

Besides the main software it is possible to save and recall the user setup i.e. application (transducer specific) and system setup to and from the floppy disk respectively. With each release of a new software a set of "Factory user setup" are included. These can be used to reset the user setup when appropriate. A software update will usually keep the user setup.

Note ! For 2102 there are two "Factory user setup" disks – one for monitor types 10", 12" and 14" and one for 15" monitor (EXL). The user setup has in this case been optimised in greyscale and contrast setting for the specific monitor. For the 2101 there are two "Factory user setup" disks one for EXL versions (default) and one for standard 2101 (12" monitor)

Before loading new software, make a copy of the user setup from the Copy Setup menu, so you have a backup: Press **Setup** then **F2** (System setup) and then **F5** (Copy setup) to get to the menu for copying and recalling the user setup.

4.8.2. Loading main software

1. Insert the floppy disk labeled "Load 000" in the floppy drive.
2. Turn on the 2101/2102.
3. When the line: "Type 2100 LOADER" appears (after approximately 3 seconds) then press **Shift, Alt, ***.
 Note ! Some units will not show this line as the warm-up period of the monitor exceeds the boot time. In that case turn on the scanner, wait 2-3 seconds and then press **Shift, Alt, *** successively for a couple of times.
4. A repeating beeping then indicates that the software load menu has been accessed. The menu shown below may look different on systems with other versions of the boot PROM.

Type 2100 LOADER VP2765 (CB2100) 10-26-2001 08:48:14

```
Select command using <key>:
<1> Upgrade scanner software using floppy disk
<2> Upgrade scanner software using serial port
<9> Reset all user programmed parameters (NVSS)
<q> Quit, no upgrade performed
```

By resetting the NVSS (by pressing **9** in the above menu) the applications(transducer setup), label library and bodymark library are set to factory default. If a default language different from English has been set by loading the "Language disk" then the names of the applications, label library, and bodymark library will be set to that language.

Note ! Not all names may have been translated.

Note! Support of "Language disk" is only for units with sw. version 2.52 (2101) / 3.0 (2102) or above.

5. Press the **1** for "**Upgrade scanner software using floppy disk**" and follow the instructions on the screen.

Note ! Do not turn off the scanner during the updates as this may cause the Flash Proms on the Core board to fail !

6. Change diskette (Load 001-002/003) when prompted.
7. At the completion of the software loading the scanner will restart.
8. Press **Shift, Alt, ID** to check that the software is correct, see below example.

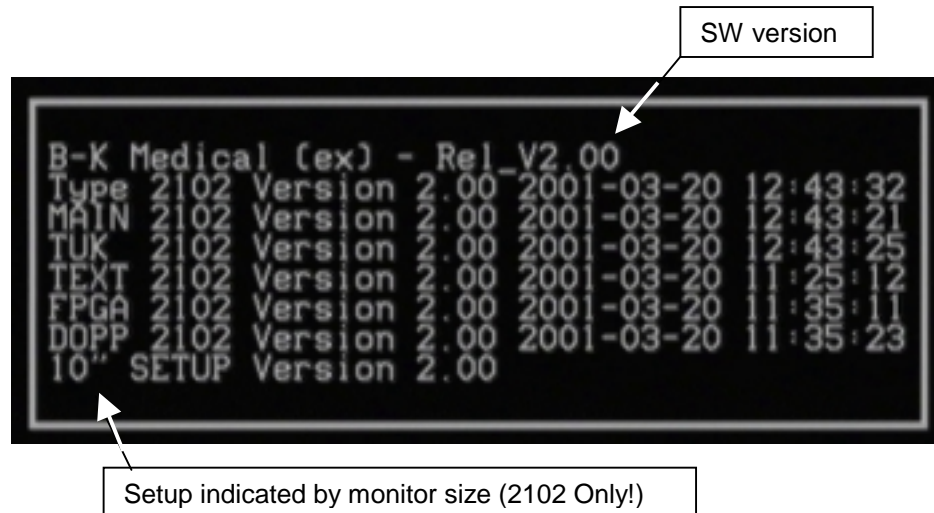

For 2102 the bottom line shows which factory setup that the user setup has been based on. This is indicated by the monitor size. If "MIXED SETUP" is shown it is because transducer setups from different based setup has been recalled individually. After a software update the version of the setup are usually lower than the SW version as the user setup are kept.

9. If the set up needs to be changed then use the "Factory setup disk" which is released together with the main software.
 - I) Insert the disk with transducer/system setup
 - II) Press "Setup", press "System Setup" (F2), press "Copy setup" (F5)
 - III) Select "Recall all transducer setup values "
 - IV) Select "Recall system setup"

4.9. Error Log on Core Board

In case the scanner stops operating during normal use the CPU (Core Board) in some cases stores information in a error log. This log can be assessed via a PC and a terminal program e.g. Windows (Hyper)Terminal.

1. Connect the PC to the scanner via the RS232 A with the cable EL4021 or similar. Note ! If the PC Back-end is mounted then use RS232 B and set DIP switch 5 to right position.
2. Use PC terminal program e.g. Procomm or Windows Terminal. Com. settings: **19200 BPS N,8,1.**
3. Set DIP switch 8 to RIGHT (scanner rear panel).
4. Switch on the scanner.
5. Press **<N>** at the prompt:
"DO YOU WANT TO MODIFY JOB ? PRESS YES TO CONFIRM".
6. Press **<N>** at the prompt:
"DO YOU WANT TO RESET TO DEFAULT SET_UP (Y/N)"
7. If any text in the error log, you will be prompted
"DO YOU WANT TO SEE THE POST MORTEM HISTORY ?"
Note ! Information will only show if the error log is not empty.
8. Then press **"y"**

Remember to set DIP switch 8 back to LEFT. After turning the scanner off.

If the contents of the error log does not make sense please then send a copy to the Service department at B-K Medical.

4.10. Trouble shooting the PC Back-end (3D system)

4.10.1. Cannot switch to 3D system – boot problem

If it is not possible to switch to 3D the cause of the failure can be diverted into two categories:

Missing control/video signal between scanner and PC Back-end or PC Back-end boot problem. To see if the 3D system boots OK the monitor can be connected directly to the VGA output of the PC Back-end. Remove the back cover, disconnect the internal VGA connector and connect the scanner monitor – see below. In general if the sound sequence (♪♪♪) is heard then the 3d system is running and boot sequence completed.

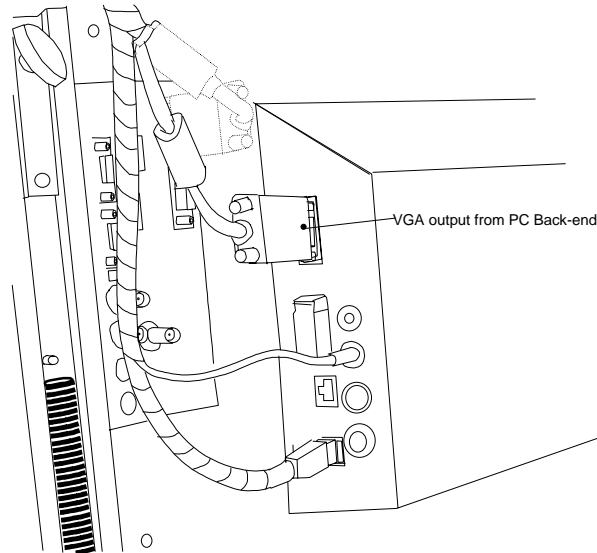

Possible cause	Look for	Actions to locate failure
Defective Video board in the scanner		
Faulty video cable from scanner		Check cable connection inside scanner
Defective VGA output	No output from VGA connector	Connect the monitor directly to the VGA output
No communication between scanner and PC Back-end		Check that DIP switch #2 is in right position. Also check that the serial cable is mounted in RS232 port A
No Transducer connected to scanner	Note ! Only a problem for scanners with sw. version 2.71(2101)/3.11(2102) or below	Connect a transducer
Defective footswitch		Try switching to 3D via the keyboard
Defective Power Supply		Check the Power Supply
Defective/not connected trackball	Connect the monitor directly to the video output from the PC backend and see if it stops during Windows boot sequence. Note ! Only a problem for scanners with sw. version 2.71(2101)/3.11(2102) or below	Connect another trackball NT0263 or connect an ordinary trackball/mouse via a keyboard splitter cable (remember to turn off the system and restart when reconnecting)
Defective/corrupt harddisk	Connect the monitor directly to the video output from the PC backend and see if it stops during Windows boot sequence.	

4.10.2. Problems with CD-ROM drive

Possible cause	Look for	Actions to locate failure
-----------------------	-----------------	----------------------------------

No power	No light in the CD drive/cannot eject	Check connections and power cable
Low voltage to the CD drive		Check that the correct (12V) connector has been used on the PC-Back-end
Cannot format a blank CD (menu does not appear)	When a blank CD is inserted into the Cd drive nothing happens.	Press <Alt><←> (back space), click on "Programs" and then on "Format blank CD"
Defective USB port or USB cable		Try the other USB connector or if possible try it on another computer
Defective CD drive		

4.10.3. Mover problems

Possible cause	Look for	Actions to locate failure
Defective mover		Activate the MCMComm 4.13
Defective MCM		Activate the MCMComm 4.13
Defective com port on PC		Activate the MCMComm 4.13
Faulty cable inside the PC-back-end		Check cable

4.10.4. Problem opening the database

Possible cause	Look for	Actions to locate failure
Corrupt database	Error message when opening the database or when adding a patient	Restore the database see service utilities in 4.11

4.10.5. 3D trackball does not work

Possible cause	Look for	Actions to locate failure
Defective trackball		
Standard trackball used instead of modified (NT0263)		Check that the trackball is the modified NT0263. If using a standard trackball it must be connected via a keyboard splitter cable
Defective mouse/keyboard port		

4.11. 3D Service mode

For service purposes it is possible to turn off the 3D application and then access the PC Back-end as a normal computer. This requires that you log on as administrator on the system.

Warning ! Do not try to run other program or do any other change in the system setup than stated in this manual !

1. Turn on the scanner and wait for the PC Back-end to complete the boot sequence.
2. Switch to 3D
3. Press ALT + ←(back space)
4. Click on "Shut Down, see below



- 5. Select "Log off life and click OK, see below.



- 6. Log on as administrator with User name: "ADMINISTRATOR" and Password: "!BK3D_AD". Note ! Some system may have been set up with the password "!bk3d_ad" instead !



7. The normal Windows desktop should now appear similar to the below picture.

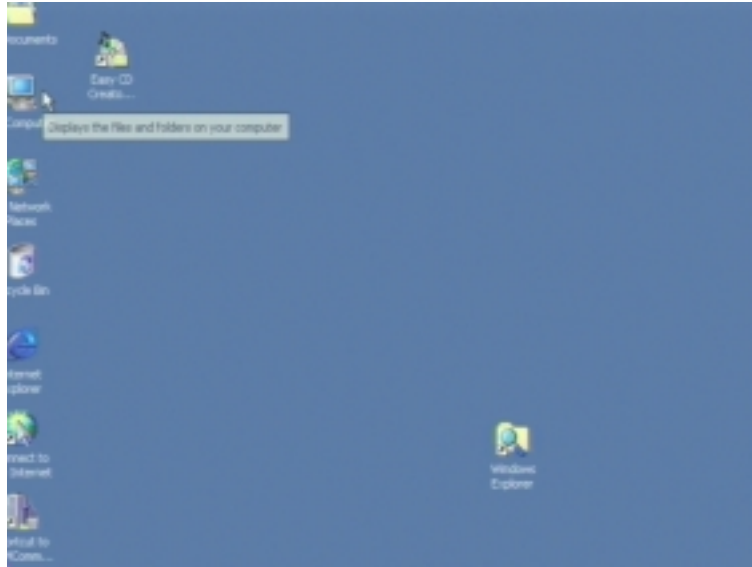

8. The service utilities are found on "C:\Program Files\Service". Use "My Computer" or "Windows Explorer" which are found on the desktop to locate the folder. See the service folder below.

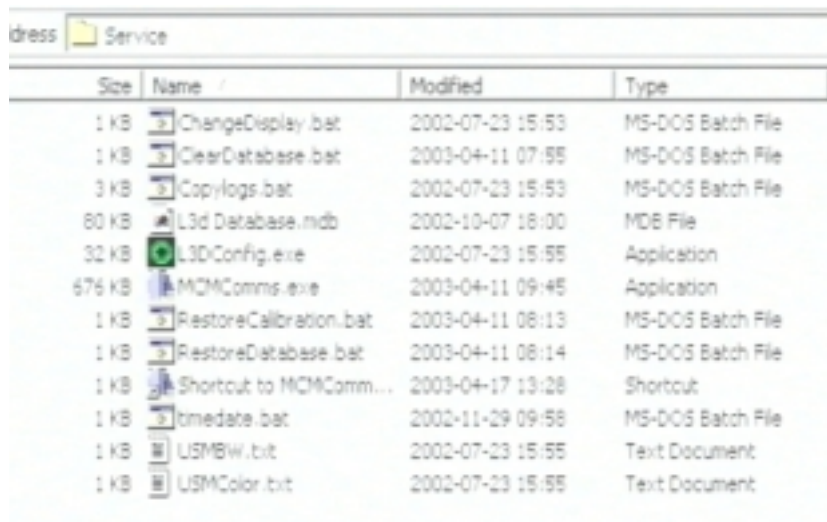

The following programs and files are available:

ChangeDisplay.bat	Not used
ClearDatabase.bat	Clears the patient database and all scans from the folder D:\scans
Copylogs.bat	
L3d Database.mdb	Empty Patient database used by "ClearDatabase"
L3DConfig.exe	Not used
MCMComms.exe	Test program for the MCM option
RestoreCalibration.bat	Restores the "Calibration Database" with a copy from the CD
RestoreDatabase.bat	Restores the "L3D Database" with a copy from the CD
ShortCut to MCMComm	
timedate.bat	Changes the time and date (also available from user menu)
LISMBW.txt	not used
LISMColor.txt	not used

4.12. 3D disk structure

The harddisk in the 3D system are partitioned in two volumes: C: and D:.

The C: drive holds the operating system (Windows 2000), the application software (3D), service utilities, patient database (L3D Database.mdb) and Calibration database (Calibration.mdb). The patient database holds information about all patients which the user has typed in via the file mode on the 3D system. It holds references to all scans saved on the harddisk and all archived files.

The calibration database holds the factory preset as well as the user presets. whenever a 3D scan has been archived to a CD it also copies the patient and calibration database to the CD as a backup.

The D: drive stores the acquired scans, imported scans from the CD and the Pagefile (Windows swap file).

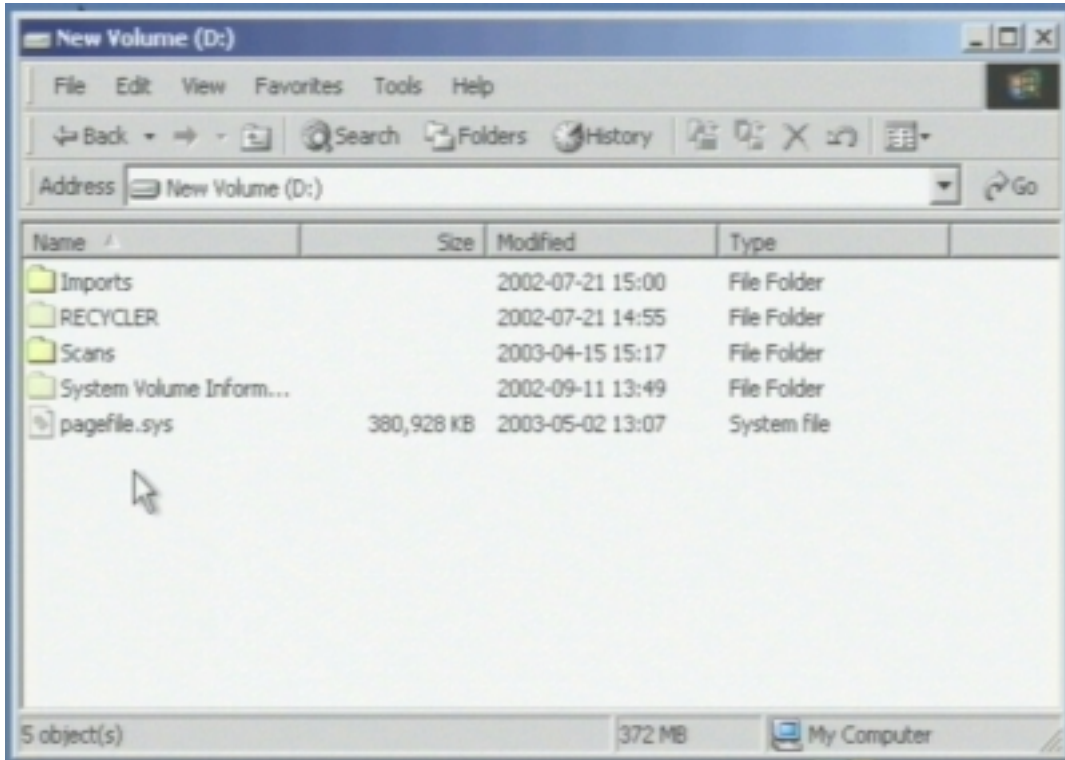

To restore the patient database use the utility in the service folder “Restore Database” , see Service Mode 4.11. Note ! This restores only the database and not the actual scans. The scan can manually be transferred to the “scans” folder on the D: drive if necessary using e.g “My Computer” in the service mode.

4.13. MCMComm

The movers are controlled by the MCM. The MCMComm is a test tool for the MCM and the movers which can be used to separate the faulty components if experience mover problems.

4.1. Go to Service mode as described in 4.11.

4.2. Double Click on the MCMComm icon on the desktop.



4.3. Click on “Ping MCM”.



4.4. The version of the MCM should now appear. If not either the MCM or the cable connecting it is faulty

4.5. If a mover is connected to the system it should be identified by using “Get Mover Type”. If it can’t be identified it can be either the mover itself or the cable to it.

4.6. Click on the arrows (left or right) to activate the mover.

4.7.

4.14. 3D software upgrade

The software version of the 3D can be seen if you click on  in the lower right corner.

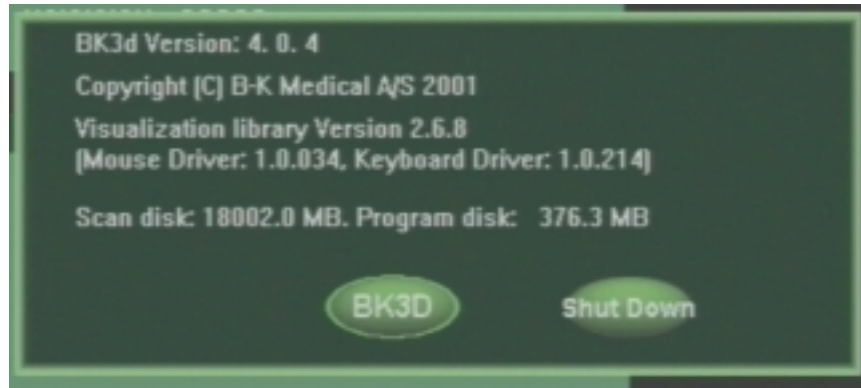

The software are updated via the CD drive.

1. Turn on the scanner and wait for the PC Back-end to complete the boot sequence.
2. Switch to 3D
3. Press ALT + ←(back space)
4. Click on " Program" and then "Upgrade"



5. Follow the instructions on the screen

This page is left blank intentionally

Section 5

ADJUSTMENT PROCEDURE

CONTENTS	PAGE
5.1. Introduction.....	5-2
5.2. 2101EXL/2102EXL Monitor Adjustment for 15" VGA monitors.....	5-2
5.2.1. Geometry adjustment for 15" VGA monitors	5-4
5.2.2. Colour Balance adjustment for 15" VGA monitors.....	5-5
5.3. 2101 Monitor Adjustment.....	5-7
5.3.1. Geometry adjustment for 12" B/W monitors	5-7
5.4. 2102 Monitor Adjustment.....	5-9
5.4.1. Geometry Adjustment for 10" and 12" monitors	5-9
5.4.2. Colour Balance for 10" and 12" monitors.....	5-11
5.5. 2102XDI Monitor Adjustment for 14" monitors	5-12
5.5.1. Geometry adjustment for 14" monitors	5-14
5.5.2. Colour Balance adjustment for 14" monitors	5-16
5.6. Monitor Friction Adjustment	5-18
5.7. Trackball Friction Adjustment.....	5-18

5.1. Introduction

Most of the adjustable components in the 2101/2102 are factory adjusted and need no further adjustment. Do not attempt to make other adjustments than stated in this section.

5.2. 2101EXL/2102EXL Monitor Adjustment for 15" VGA monitors

The Brightness and Contrast of the monitor can be adjusted by the user via the buttons on the front of the monitor and should be adjusted according to the ambient light level in the room where the scanner is used. When leaving the factory the Brightness is set to "16" and the Contrast "85" but these values may be necessary to adjust. Note that in many cases the scanning takes place in a dimmed light environment so the adjustment should be made accordingly.

To help adjusting the Brightness and Contrast three test screens can be activated:

1. Two dark squares where one is 2/255 and the other is 4/255 of 100% white, for adjusting Brightness, see below.
Note: Before you can visualize the squares you might have to turn the Brightness to 100%
It should be adjusted so the 2/255 part (top) disappear and the 4/255 (lower) is just visible.

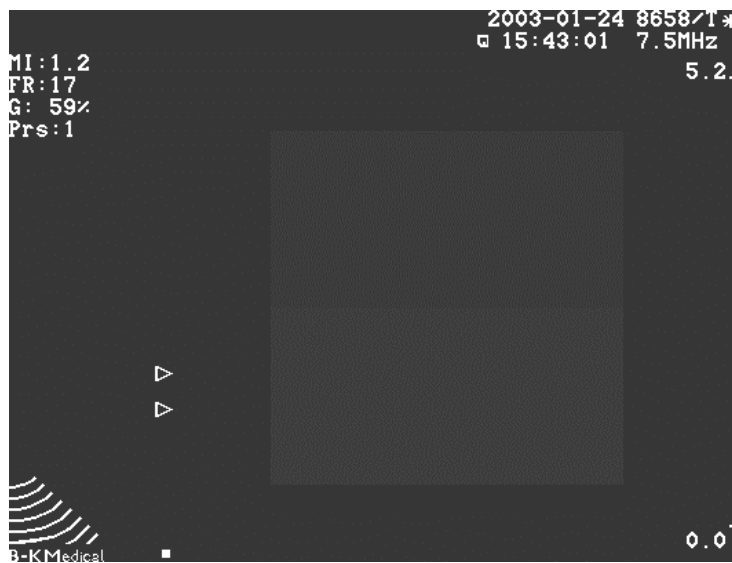

Fig. 5.2-1. The Square for brightness adjustment of the 15" monitor.

2. A square filled out with 100% white, for Contrast adjustment.
3. A test picture displaying a linear 8 step grayscale for final check of monitor adjustment.

Pressing **Shift**, **Alt**, and **G**, toggles between these screens and test screen OFF (The scanner must be in freeze mode).

The adjustment of the 15" monitor is done by accessing an On Screen Display menu which are activated via buttons on the front the monitor. When changes has been made these will automatically be stored in an internal memory. Two sets of geometry settings stored are stored: One for PAL and one for NTSC (the differences in the VGA signal is the frequency). As the monitor automatically detects the video format from the scanner it should be checked that it has been set to the correct video format - refer to section 9. The setting for the colour balance is the same for both standards. The buttons which can be activated are shown below.

The monitor can operate in two modes: *Normal* and *Factory* mode. *Normal* mode is for normal use and *Factory* mode is for adjusting the monitor. Note ! In *Factory* mode the monitors default setting are changed so care should be taking when changing these.

The On Screen Menu is activated by pressing the **MENU** button. In *Normal* mode the menu disappears after approx. 15 sec. if no keys are activated. In *Factory* mode the On Screen Menu stays active. In *Factory* mode some additional adjustments are possible. After power off the monitor starts up in *Normal* mode. To activate *Factory* mode press and hold the **MENU** button. Press **▽ BRIGHTNESS** a number of times (5-10 !) until the On Screen Menu turns red. (In *Normal* mode the menu background is blue).

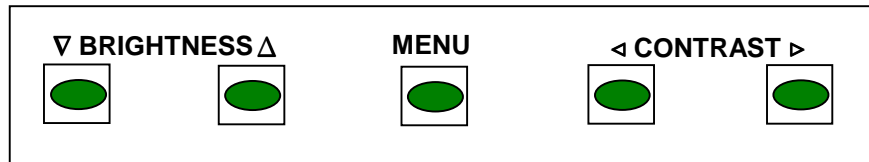
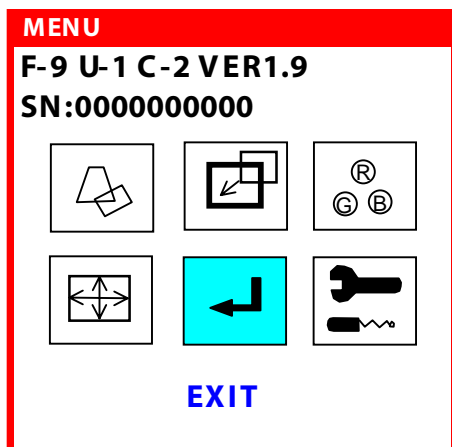



Fig. 5.2-2. The Adjustments buttons on the front of the 15" monitor.



- Geometry
- Center
- Color
- Size
- Exit
- Utility

Fig. 5.2-3. The main On Screen Menu.

5.2.1. Geometry adjustment for 15" VGA monitors

1. Check that the scanner has been set to the right video format - refer to section 9.
2. Switch On the 2101/02EXL and press the **Shift, Alt** and  Then press **F5** to chose the Test picture. (Pressing **F5** toggles between Geometric test picture, all pixel off, and all pixels on)

Note: Allow the monitor to warm up for at least 20 minutes before adjusting.

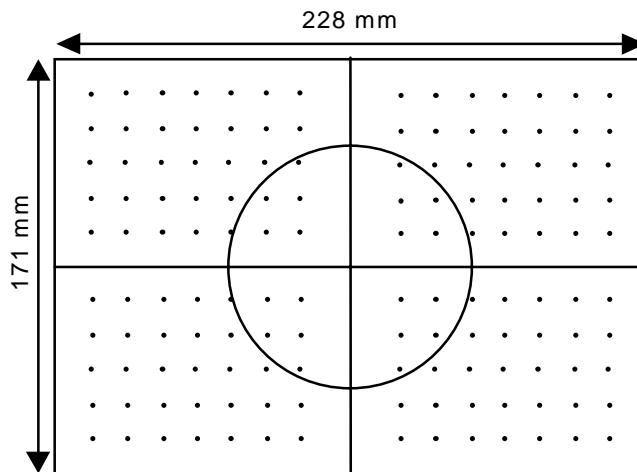

Fig. 5.2-4 The Geometric Test Picture on a 15" monitor

3. The geometry of the screen can if necessary be adjusted by the following steps:
4. Activate *Factory* mode by pressing and holding the **MENU** button. Then press **▽ BRIGHTNESS** a number of times (5-10 !) until the On Screen Menu turns red.
5. Press **◀ CONTRAST** until *SIZE* appears and then press **MENU**.
6. Adjust the size matching the above figure and leave the menu pressing **MENU**.
7. Press **◀ CONTRAST** until *GEOMETRY* appears and then press **MENU**.
8. Adjust *PINCUSHION* to achieve a correct rectangle and then press **MENU**.
9. If the circle are not circular then readjust the size as in step 5-6.
10. Press **◀ CONTRAST** until *CENTER* appears and then press **MENU**.
11. Adjust the placement to centre the test picture on the screen.

5.2.2. Colour Balance adjustment for 15" VGA monitors

The colour balance is adjusted with the Philips Colour Analyser PM5639
Set-up values for the colour analyser, refer to the PM5639 user manual:

CRT/PH	EBU
WH. Ref	ZV0065
X =	0.261
Y =	0.272
Lumi. Units	NIT
Maus. Mode	R&B/G

Note: Allow the monitor to warm up for at least 20 minutes before adjusting.

1. Activate *Factory* mode by pressing and holding the **MENU** button. Then press **▽ BRIGHTNESS** a number of times (5-10 !) until the On Screen Menu turns red.
2. Leave the menu by pressing **MENU**
3. Set the Contrast and the Brightness to max.
4. Press **MENU** to activate the main On Screen Menu.
5. Press **◀ CONTRAST** until *COLOR* appears and then press **MENU**.
6. Press **◀ CONTRAST** until *USER* is selected (Turns red).
7. Press **BRIGHTNESS Δ** until *SUB CONTRAST* appears and adjust it to max. pressing **CONTRAST ▶**.
8. Press **BRIGHTNESS Δ** until *BLUE GAIN* appears and adjust it to max. pressing **CONTRAST ▶**.
9. Press **Shift, Alt** and  on the 2101/02EXL and select the "white" test-picture.
10. Place the colour analyser sensor on the picture tube so that there are min. 2 cm to the edge of the white test screen and min. 2 cm. to the On Screen Menu.
11. Press **BRIGHTNESS Δ** until *GREEN GAIN* appears and adjust it to 5% of blue colour using **◀ CONTRAST ▶**.
12. Press **BRIGHTNESS Δ** until *RED GAIN* appears and adjust it to 5% of green and blue colour using **◀ CONTRAST ▶**.
13. Select the "black" test image (F5 on the scanner keyboard)
14. Press **BRIGHTNESS Δ** until *SUB BRIGTHNESS* appears and adjust it to 3 NIT ± 0.2 NIT using **◀ CONTRAST ▶**.
15. Select the "white" test image (F5 on the scanner keyboard).
16. Press **BRIGHTNESS Δ** until *RED GAIN* appears and adjust it to 5% of green colour using **◀ CONTRAST ▶**.
17. Press **BRIGHTNESS Δ** until *BLUE GAIN* appears and adjust it to 5% of green and red colour using **◀ CONTRAST ▶**.
18. Check that the intensity is > 70 Nit.

19. Select the "black" test image (F5 on the scanner keyboard)
20. Leave the On Screen Menu by pressing **MENU** twice.
21. Adjust Brighthness to 0,5 Nit \pm 0,1 Nit
22. Press **MENU** to activate the main On Screen Menu.

23. Press **◀ CONTRAST** until *COLOR* appears and then press **MENU**.

24. Press **◀ CONTRAST** until *USER* is selected (Turns red).

25. Press **BRIGHTNESS Δ** until BLUE BIAS appears and adjust it to 10% of green colour using **◀ CONTRAST ▷**.
26. Press **BRIGHTNESS Δ** until RED BIAS appears and adjust it to 10% of blue green colour using **◀ CONTRAST ▷**.
27. Power off the monitor , wait a few seconds and then turn it on again (leaving *Factory mode*)
28. Press **MENU** and press **CONTRAST ▷** until *Utility* appears and then press **MENU**.
29. Press **BRIGHTNESS Δ** until RECALL appears and select YES pressing **CONTRAST ▷**. (It automatically goes to no when the Recall action has been carried out)
30. Press **MENU** twice to leave the On Screen Menu.

5.3. 2101 Monitor Adjustment

5.3.1. Geometry adjustment for 12" B/W monitors

Necessary tools:

- a long, flexible, non-magnetic and non-conductive screwdriver.
1. To get access to the potentiometers inside the monitor follow the procedure described in section 6, getting access to interior of the Monitor for Adjustment.

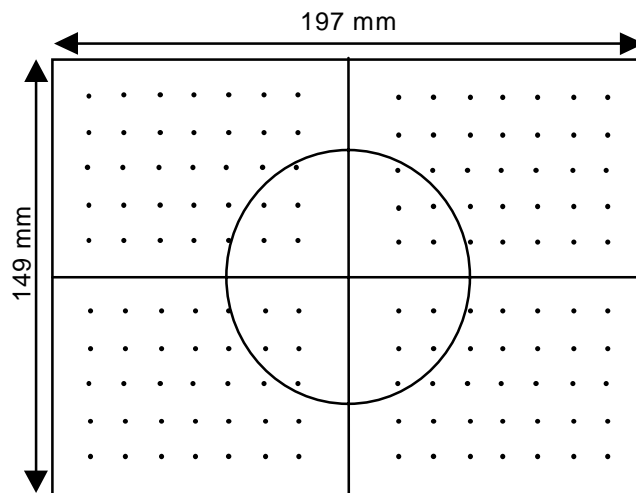



Fig. 5.2-1 *The Geometric Test Picture.*

2. Switch On the 2101 and press the **Shift, Alt** and  Then press **F5** to chose the Test picture. (Pressing **F5** toggles between Geometric test picture, all pixel off, and all pixels on)

Note:

The Height should always be checked/adjusted following any exchange of monitor or power supply. Variations in the 12V DC from the power supply may cause change of the vertical image size. To check this go directly to step 5.

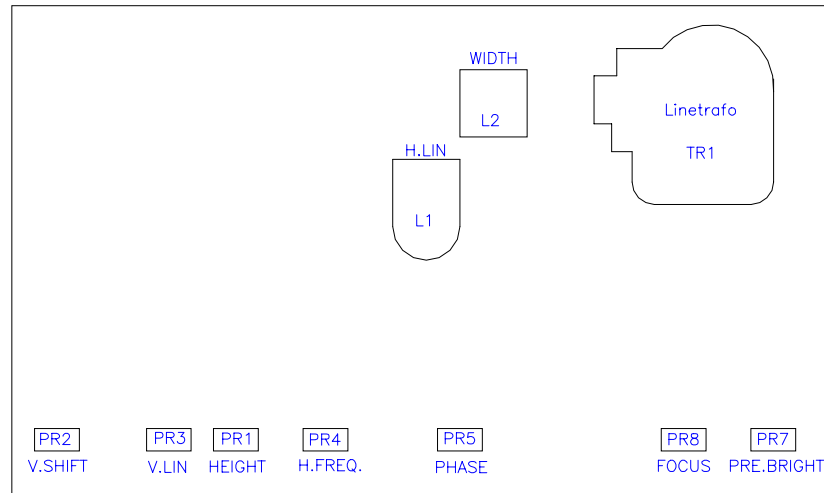

Fig. 5.2-2. *The Deflection Board Layout.*

The following adjustments (step 3 - 11) are done on the Deflection PCB (refer to Fig. 5.2-2):

Allow the monitor to warm up for at least 15 minutes before you proceed with step 3.

3. Phase: Turn up the brightness until the background light is visible. Then adjust Phase (PR5) so that the test picture is located in the centre of the background light area.
4. Horizontal Linearity: Adjust the core H. Lin (L1) till the circles left and right side have an equally long distance to the centre.
5. Ext. Height: Adjust Ext. Height (PR1) so that the height of the test picture is 143 mm.
6. Ext. Width: Adjust Width (L2) so that the width of the test picture is 190 mm.
7. Vertical Linearity: Adjust V. Lin (PR3) till the circles top and bottom have an equally long distance to the centre.
8. Vertical Shift: Adjust V. Shift (PR2) till the test picture is located vertically in centre.
9. Focus: Check the focus of the test picture. If necessary adjust, with a normal brightness setting, Focus (PR8). Adjust for best compromise between centre and corners of the test picture.
10. Brightness: Set the external brightness potentiometer to two thirds of the max value. Adjust Pre. Bright (PR7) till the background light is just visible.
11. Switch Off the 2101 and re-assemble the monitor.

5.4. 2102 Monitor Adjustment

5.4.1. Geometry Adjustment for 10" and 12" monitors

Necessary tools for 10" and 12" monitors:

- A non-magnetic and non-conductive screwdriver.
1. To get access to the potentiometers inside the monitor follow the procedure described in section 6, getting access to interior of the Monitor for Adjustment.

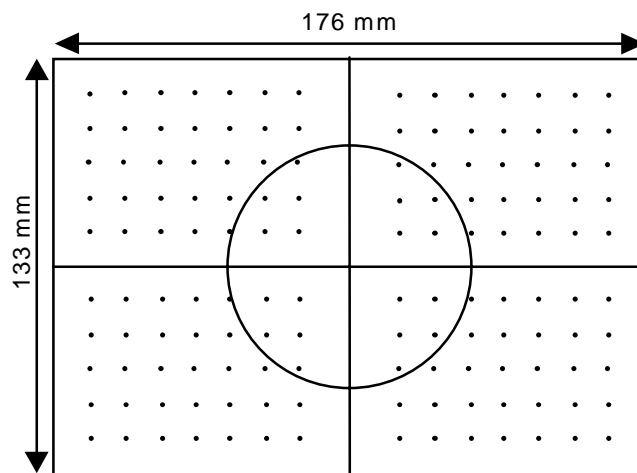

Fig. 5.3-1 The Geometric Test Picture on a 10" monitor

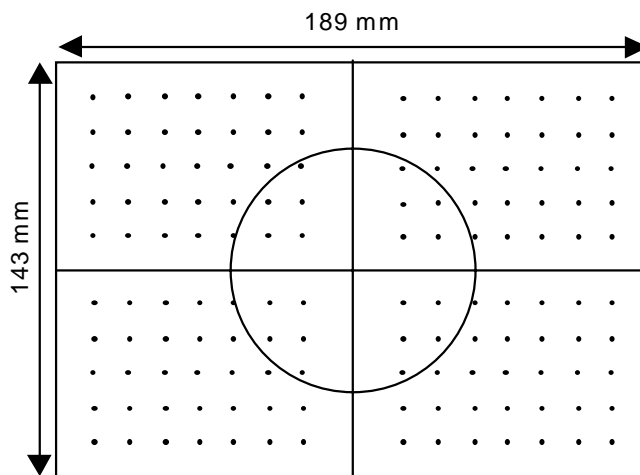



Fig. 5.3-2 The Geometric Test Picture on a 12" monitor

2. Switch On the 2102 and press the **Shift, Alt** and  Then press **F5** to chose the Test picture. (Pressing **F5** toggles between Geometric test picture, all pixel off, and all pixels on)

Note: Allow the monitor to warm up for at least 15 minutes before adjusting.

3. Check the geometry of the test picture and if necessary adjust the size with HEIGHT and WIDTH.
Adjust the roundness of the circle with V. LIN and H. LIN. The position of the test picture is adjusted with V. SHIFT and PHASE.

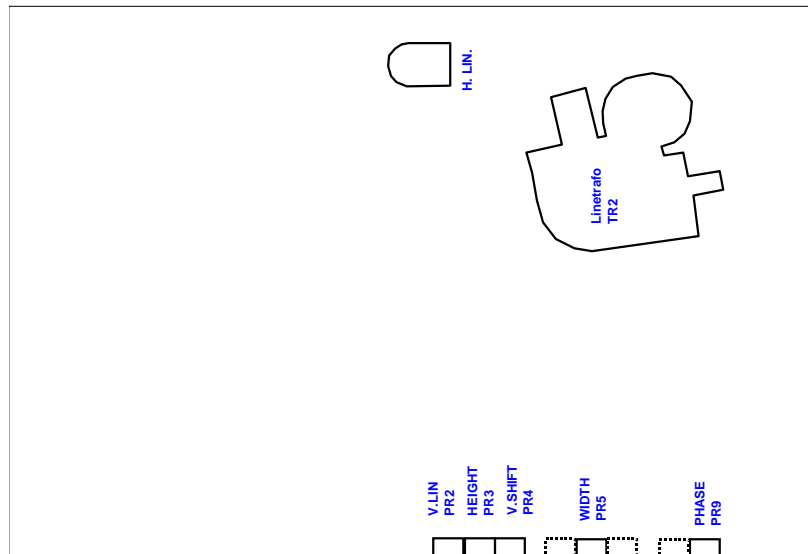

Fig. 5.3-3. *The Deflection Board Layout.*

5.4.2. Colour Balance for 10" and 12" monitors

The colour balance is adjusted with the Philips Colour Analyser PM5639
Set-up values for the colour analyser, refer to the PM5639 user manual:

CRT/PH	EBU
WH. Ref	ZV0050 (10") / ZV0051 (12")
X =	0.267
Y =	0.272
Lumi. Units	NIT
Maus. Mode	RGB/Luminance

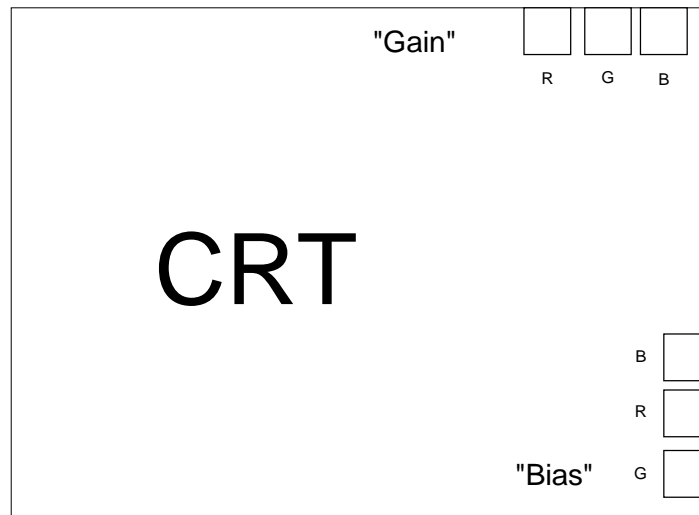



Fig. 5.3-4. CRT PCB, rear view

1. Remove the anti-glare screen and place the sensor on the picture tube.
2. Press **Shift, Alt** and  on the 2102 and select the "black" test-picture
3. Set the Contrast pot. to min. and the Brightness pot. to max. and check that the intensity is > 3 Nit (typically 40 NIT). The intensity can be adjusted with the "Bias" pots (Fig. 5.3.4).
4. Adjust the brightness pot. to a read-out of approximately 1.5 NIT ($1.3 \leq X \leq 1.7$). Check that the RGB amplitudes does not differ more than 8% (0.12NIT). If necessary adjust the three bias pot's and then also check step 3.
5. Adjust brithtness pot. to approximately 0.5 NIT ($0.4 \leq X \leq 0.6$).
6. Select the "white" test picture.
7. Set contrast to max. and check that the intensity is >150 NIT.
8. Adjust contrast to approximately 150 NIT ($140 \leq X \leq 160$).
9. Check that the RGB amplitudes does not differ more than 13% (20 NIT). If necessary adjust with the three Gain pots (Fig. 5.3.4) and then also check from step 7.

5.5. 2102XDI Monitor Adjustment for 14" monitors

The adjustment of the 14" monitor is done by accessing an On Screen Display menu which are activated via buttons inside the monitor. When changes has been made these will automatically be stored in an internal memory. Two sets of geometry settings stored are stored: One for PAL and one for NTSC. As the monitor automatically detects the video format from the scanner it should be checked that it has been set to the correct video format - refer to section 9. The setting for the colour balance is the same for both standards.

The buttons which can be activated are shown below. To get the On Screen Menu the **mode** switch must be set to position "U" and then the **status** switch must be pressed. Pressing the **status** switch makes the On Screen Menu toggle between a status menu, five adjustment menus and no menu (On Screen Menu off).

In the adjustment menus the cursor is moved by pressing **cursor+** or **cursor-** and the value of the active function can be changed by pressing **adjust+** or **adjust-**. After changing a value you must move the cursor or change the menu by pressing **status** before the On Screen Menu times out in order to save the value.

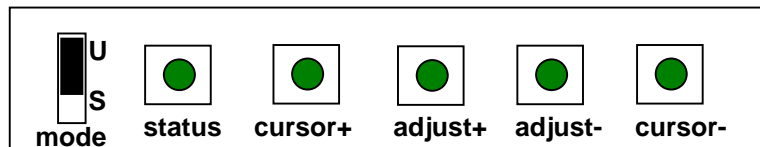

Fig. 5.3-5. The Adjustments buttons inside the 14" monitor.

When pressing the **status** switch the following menu's will appear successively. The symbols/abbreviations are shown as well as the text indicating the function.

<p>H 31.25 KHz V 50.01 Hz</p>
<p>HDTV</p>

(Scanner in PAL mode)

<p>H 31.51 KHz V 60.00 Hz</p>
<p>640x480</p>

(Scanner in NTSC mode)

Fig. 5.3-6. The status menu.

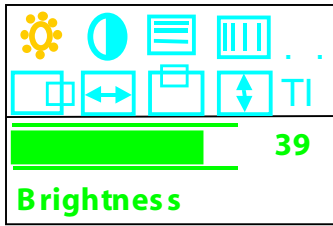

Brightness
 Contrast
 Horizontal Moire
 Ver. Moire
 N/A
 Horizontal Position
 Horizontal size
 Vertical Size
 Tilt

Fig. 5.3-7. *The Image size menu.*

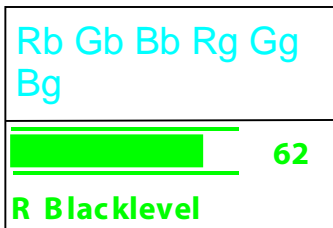

Rb (Red bias)
 Gb (Green bias)
 Bb (Blue bias)
 Rg (Red gain)
 Gg (Green gain)
 Bg (Blue gain)

Fig. 5.3-8. *The Colour adjust menu.*

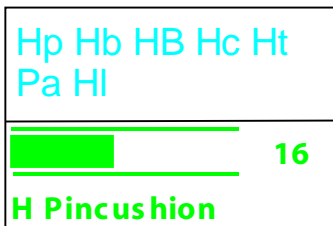

Hp (Hor. Pincushion)
 Hb (Hor. Pincushion balance)
 HB (Hor. Lin. Balance)
 Hc (Hor. Corner)
 Ht (Hor. trapezium)
 Pa (Hor. Parallelogram)
 Hl (Hor. Linearity)

Fig. 5.3-9. *The Horizontal geometry menu.*

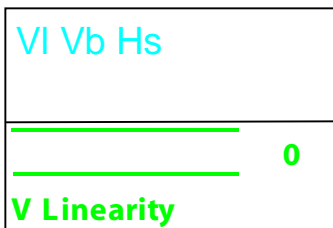

VI (Ver. Linearity)
 Vb (Ver. Lin. Balance)
 Hs (Hor. DC shift) NOT IMPLEMENTED !

Fig. 5.3-10. *The Vertical geometry menu.*

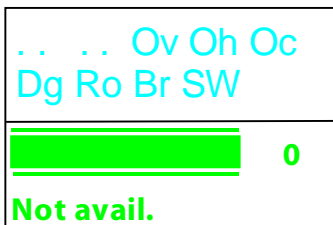

.. (N/A)
 .. (N/A)
 Ov (OnScreenDisplay Ver. Position)
 Oh (OnScreenDisplay Hor. Position)
 Oc (OnScreenDisplay Contrast)
 Dg Degauss
 Ro (Rotate)
 Br (Bright)
 SW (SW version for monitor)

Fig. 5.3-11. *The Miscellaneous menu.*

5.5.1. Geometry adjustment for 14” monitors

1. To get access to the adjustment buttons inside the monitor follow the procedure described in section 6, getting access to interior of the Monitor for Adjustment.
2. Check that the scanner has been set to the right video format - refer to section 9.
3. Switch On the 2102XDI and press the **Shift, Alt** and  Then press **F5** to chose the Test picture. (Pressing **F5** toggles between Geometric test picture, all pixel off, and all pixels on)

Note: Allow the monitor to warm up for at least 15 minutes before adjusting.

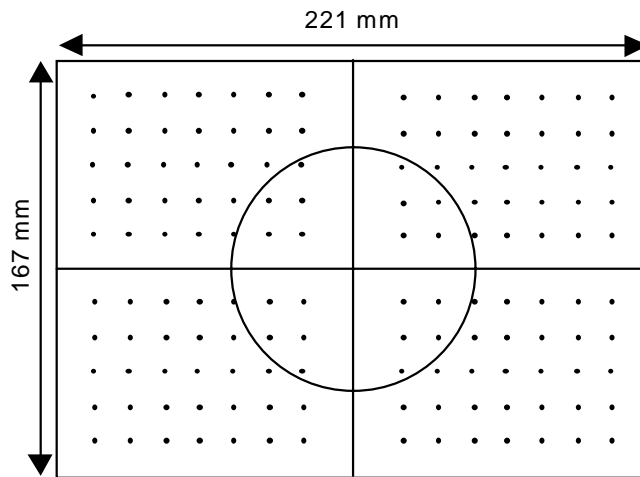
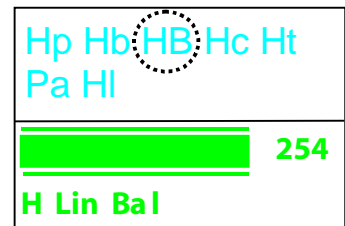
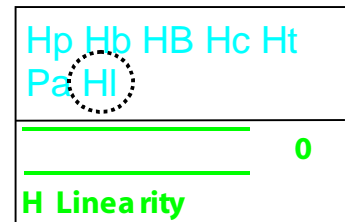



Fig. 5.3-12 The Geometric Test Picture on a 14” monitor

4. The geometry of the screen can if necessary be adjusted by the following steps:
5. Set the **Mode** switch in position “**U**”.
6. Press **status** untill you are in the Horizotal geometry menu.
7. Set Hor. Lin. Bal. to (**HB**) 254.



8. Set Hor. Linearity (**HI**) to 0.



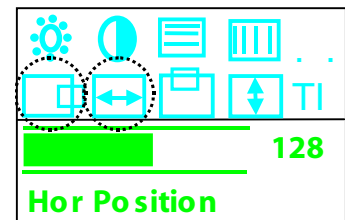

9. Press **status** untill you are in the Image size menu.
10. Adjust Hor. Size () and Hor. Pos. () so that the test pattern has the correct width and is placed in the middle of the screen.

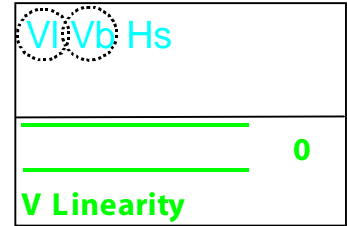

11. Press **status** until you are in Vertical geometry menu.
12. Adjust Ver. lin. (**VI**) and Ver. bal. (**Vb**) so that the dots in the test picture has an equal distance to each other and are symmetric in respect to the horizontal middle line.



13. Press **status** until you are in the Image size menu.
14. Adjust Ver. Size () and Ver. Pos. () so that the test pattern has the correct height and is placed in the middle of the screen.
15. Set the **mode** back to position "S".



5.5.2. Colour Balance adjustment for 14" monitors

The colour balance is adjusted with the Philips Colour Analyser PM5639
Set-up values for the colour analyser, refer to the PM5639 user manual:

CRT/PH	EBU
WH. Ref	ZV0060
X =	0.249
Y =	0.246
Lumi. Units	NIT
Maus. Mode	R&B/G

1. Press **Shift, Alt** and  on the 2102XDI and select the "black" test-picture.
2. Set the **mode** switch to position "U".

3. Press **status** until you are in the Miscellaneous menu.
4. Set OnScreenDispaly Hor. Pos. (**Oh**) to minimum (menu positioned to the far left)

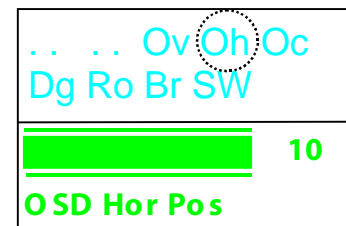

5. Place the sensor on the picture tube so that it does not measure the OnScreen Display menu.
6. Set the Contrast and the Brightness potentiometers to max.
7. Press **status** until you are in the Colour adjust menu.
8. Adjust Gain (Rg, Gg, and Bg) to maximum (63).

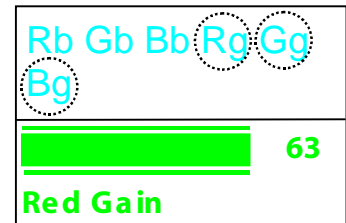

9. Check that the intensity is 5 Nit \pm 0.5 NIT. The intensity can be adjusted by changing the values of bias (Rb, Gb, and Bb).

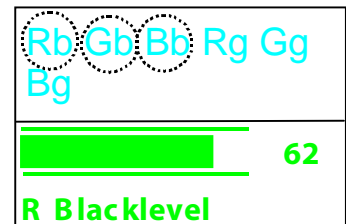

10. Check that the RGB amplitudes does not differ more than 5% (0.25NIT). If necessary adjust the values of bias (Rb, Gb, and Bb) and go to step 9 again.
Note: If the RGB amplitudes does not differ more than 5% and it is only the NIT that needs to be adjusted the Bright Adj (**Br**) in the Miscellaneous menu can be changed as all colours then will be affected.
11. Set the Contrast potentiometer to middle position.
12. Adjust the Brightness potentiometer so that the intensity is 1 NIT \pm 0.2 NIT

13. Check that the R, G, and B amplitudes does not differ more than 5% (0.25NIT). If necessary adjust the values of bias (Rb, Gb, and Bb) and go to step 12 again.

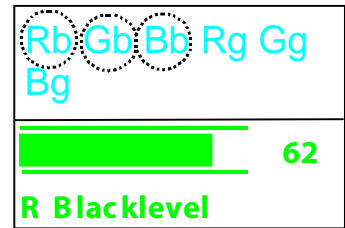

14. Select the "white" test picture.

15. Adjust Contrast potentiometer down so that the intensity is 80 NIT ± 10 NIT.

16. Check that the RGB amplitudes does not differ more than 5%. If necessary adjust the values of gain (Rg, Gg, and Bg) leaving one of them as the maximum value (63).

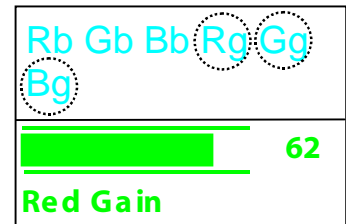

17. Toggle between the "white" and the "black" test picture without adjusting the Contrast and Brightness potentiometers.

18. With the "black" picture selected check that the RGB amplitudes does not differ more than 5%. If necessary adjust the values of bias (Rb, Gb, and Bb).

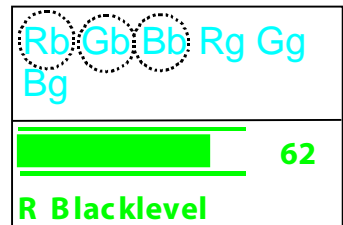

19. With the "white" picture selected check that the RGB amplitudes does not differ more than 5%. If necessary adjust the values of gain (Rg, Gg, and Bg) leaving one of them as the maximum value (63).

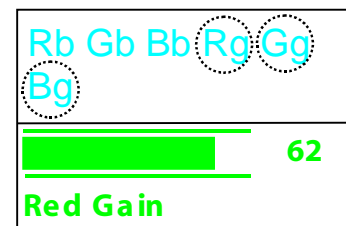

20. Adjust contrast and Brightness potentiometers to maximum.

21. Select the "black" test picture.

22. Press **status** until you are in the Miscellaneous menu.

23. Adjust Brightness Adjust (**Br**) so that the intensity is 5 NIT ± 0.5 NIT.

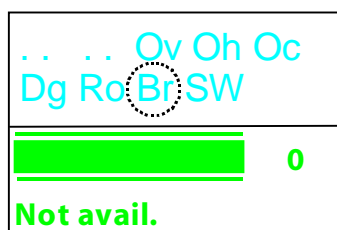

24. Select the "white" test picture.

25. Check that the intensity is > 110 NIT.

5.6. Monitor Friction Adjustment

The friction of the monitor tilt movement can be adjusted with a 4 mm. Allan key. The screws can be accessed from underneath the monitor as shown in figure 5.4-1 below. The friction is factory adjusted to 2000 - 2200 grams force on the handle in front of the

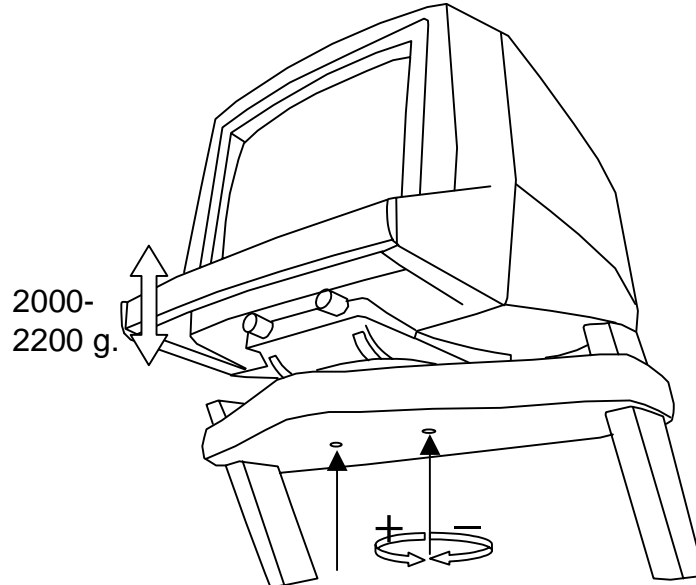

monitor.

Fig. 5.4-1. Monitor tilt friction adjustment

5.7. Trackball Friction Adjustment

The trackball should move smoothly. If it is too tight or too loose it can be adjusted using the adjusting tool (QA0228) which is placed in the compartment underneath the keyboard. Turn clockwise to tighten and counter clockwise to loosen the trackball. The trackball can be removed completely for cleaning.

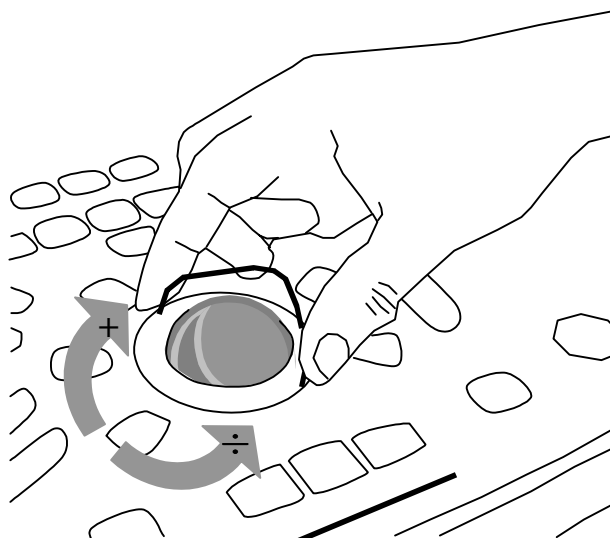

Section 6

MECHANICAL PARTS

CONTENTS	PAGE
6.1. Dismantling and Reassemble Procedures	6-3
6.1.1. Removing the Electronic Cassette	6-3
6.1.2. Getting access to the floppy disk drive	6-7
6.1.3. Replacing the single input module	6-8
6.1.4. Replacing the Floppy disk drive	6-10
6.1.5. Replacing the ECG module	6-11
6.1.6. Replacing the Power Supply	6-12
6.1.7. Replacing the Fans	6-14
6.1.8. Getting access to the PC boards	6-15
6.1.9. Replacing the Front-end board	6-16
6.1.10. Replacing the Delay board	6-17
6.1.11. Replacing the Doppler board	6-17
6.1.12. Replacing the Core board assembly	6-18
6.1.13. Replacing the Motherboard	6-20
6.1.14. Removing the keyboard	6-22
6.1.15. Getting access to the inside of the keyboard	6-24
6.1.16. Replacing the trackball	6-24
6.1.17. Removing the potentiometer module	6-24
6.1.18. Removing the Gain board	6-24
6.1.19. Replacing the monitor	6-26
6.1.20. Getting access to the interior of monitor for adjustment (10", 12" and 14")	6-30
6.1.21. Getting access to the PC Back-end	6-32
6.1.22. Remove the power supply	6-33
6.1.23. Remove the frame grabber	6-34
6.1.24. Remove the MCM boards	6-35
Exploded Views	6-37
6.2.1. Overview (front)	6-37
6.2.2. Monitor assembly exploded view	6-38
6.2.3. Monitor assembly part list	6-39
6.2.4. Cassette assembly exploded view	6-40
6.2.5. Cassette assembly part list	6-40
6.2.6. Trolley assembly exploded view	6-42
6.2.7. Trolley assembly part list	6-43
6.2.8. Keyboard assembly exploded view	6-44
6.2.9. Keyboard assembly part list	6-45
BI2102-D	6-1

This page is left blank intentionally

6.1. Dismantling and Reassemble Procedures

6.1.1. Removing the Electronic Cassette

1. Disconnect the mains cable, remove all transducers from the transducer connectors and disconnect the connector from the keyboard on the front, see Fig. 6. 1-1.

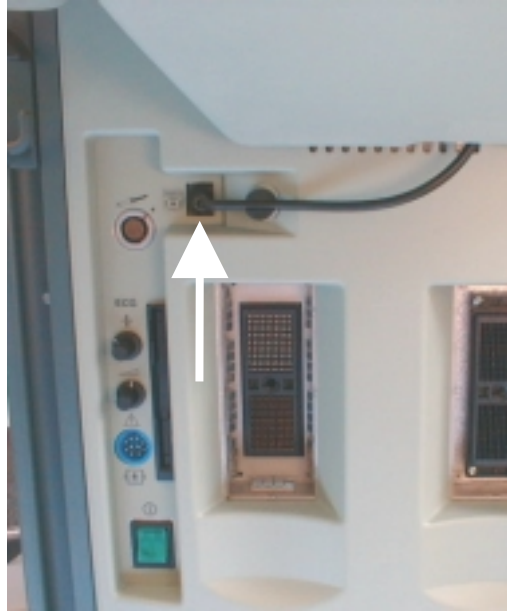

Fig. 6. 1-1. Disconnect the keyboard connector

2. Disconnect the video and the power connector from the monitor on the back of the scanner, see Fig. 6. 1-2. If the PC Back-end is installed then also disconnect the power and USB connections to the CD-RW.

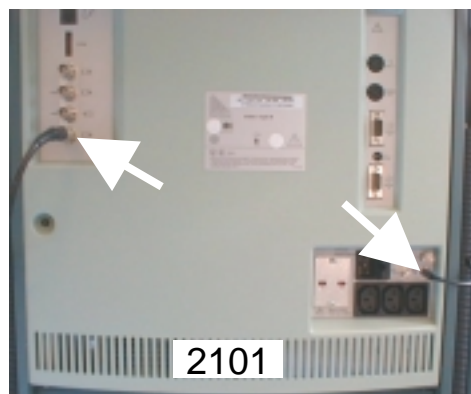
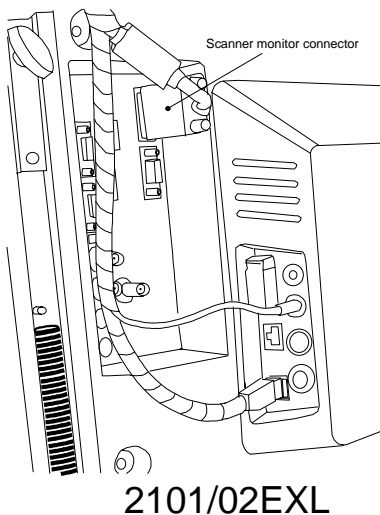

Fig. 6. 1-2. Video and Power connector from the monitor

3. Remove the two side bar covers on top of the two sidebars, see Fig. 6. 1-3.



Fig. 6. 1-3. Remove the side bar cover

4. Slide up the monitor so that the back cover can be removed, see Fig. 6. 1-4.



Fig. 6. 1-4. Position of the monitor when removing the back cover

5. Unscrew the two screws (M3×8) and remove the back cover, see Fig. 6. 1-5. Note – On some EXL scanners with PC Back-End it is necessary to remove a protective cover and disconnecting the RS232 connector before removing the back cover.



Fig. 6. 1-5. Removing the back cover



Fig. 6. 1-6. Removing the RS232 cover

6. Loosen the four screws (M4×8) holding the four metal plates on the cassette, see Fig. 6. 1-7.

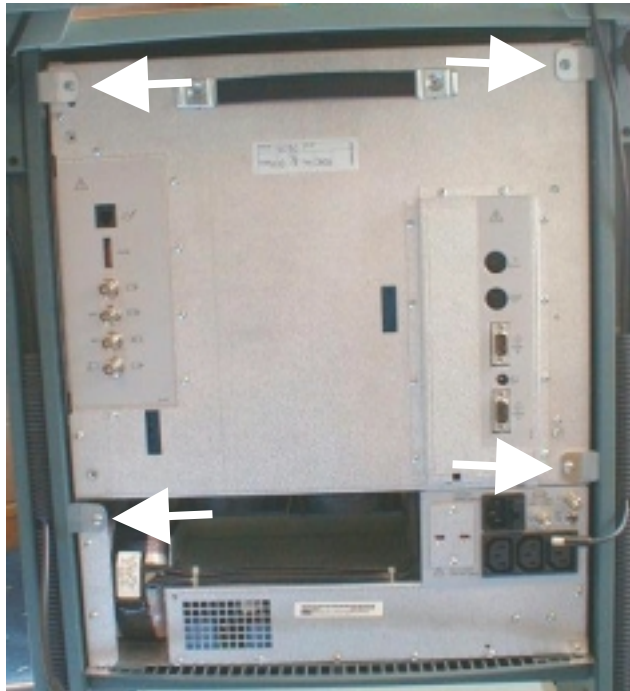

Fig. 6. 1-7. The four metal plates to be loosened

7. Pull out the cassette, see Fig. 6. 1-8.

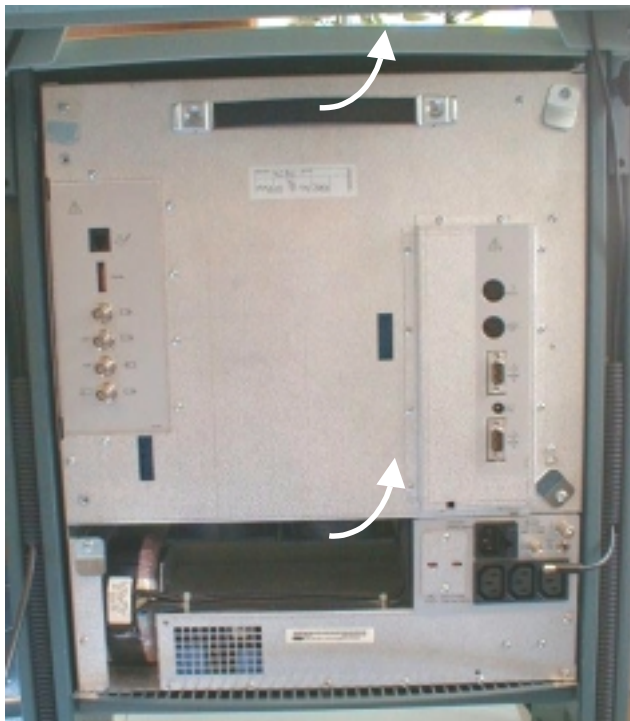





Fig. 6. 1-8. Pulling out the cassette

6.1.2. Getting access to the floppy disk drive

Remove the electronic cassette as described in section 6.1.1 Removing the Electronic Cassette.

1. If the unit has the ECG option then remove the two potentiometer buttons by taking off the top of the button and then loosen the screw underneath, see Fig. 6. 1-9. (marked )
2. Unscrew the five screws (M3x6 marked ) on the cassette, see Fig. 6. 1-9.
3. Loosen the three screws (M3x6 marked ) on the cassette, and remove the metal plate covering the floppy disk drive, see Fig. 6. 1-9.

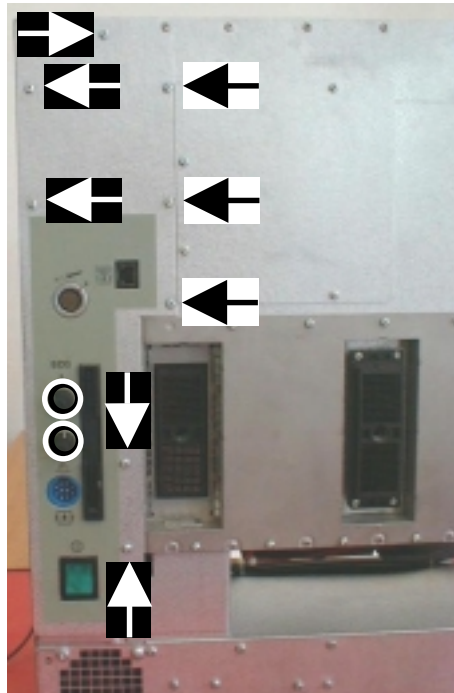

Fig. 6. 1-9. Screws holding the floppy disk cover

6.1.3. Replacing the single input module

Remove the electronic cassette as described in section 6.1.1 Removing the Electronic Cassette

Remove the metal plate described in section 6.1.2 Getting access to the floppy disk drive.

1. Unscrew the screw (M3×6) on the back of the cassette holding the Single module, see Fig. 6. 1-10.

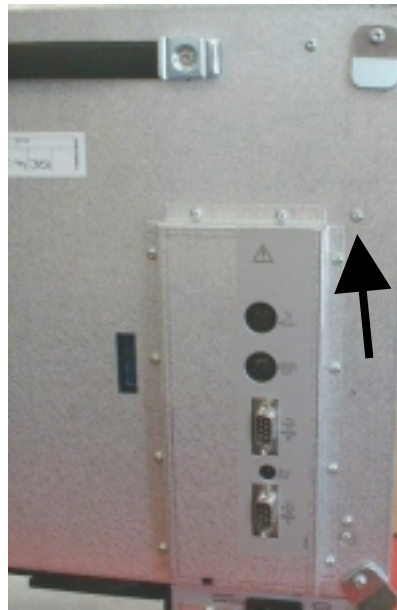

Fig. 6. 1-10. Screw holding the Single module

2. Disconnect the connector on the Mother board, see Fig. 6. 1-11.

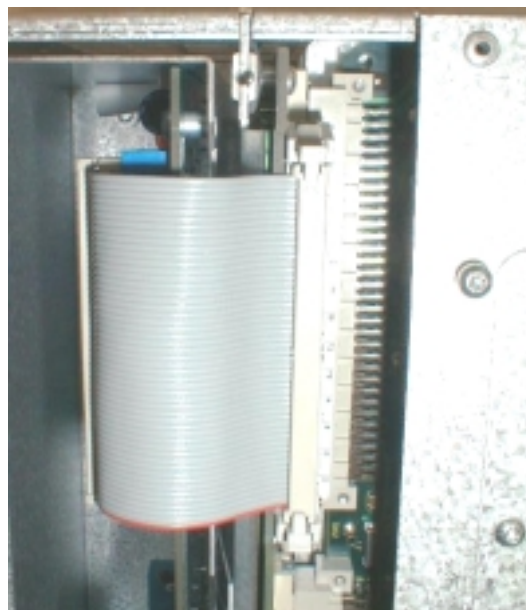

Fig. 6. 1-11. Connector from single module

3. Pull out the Single module. Note that the module has to be tilted as shown to get out of the cassette, see Fig. 6. 1-12.



Fig. 6. 1-12. Pulling out the Single module

4. Replace the single module and reverse the dismantling procedures.

6.1.4. Replacing the Floppy disk drive

Remove the electronic cassette as described in section 6.1.1 Removing the Electronic Cassette.

Remove the metal plate described in section 6.1.2 Getting access to the floppy disk drive.

Remove the single module (if installed) as described in section 6.1.3.

1. Unscrew the screw holding the floppy disk drive, see Fig. 6. 1-13.



Fig. 6. 1-13. Screw holding the Floppy disk drive

2. Disconnect the connector on the Motherboard and if necessary also disconnect the ECG connector, see Fig. 6. 1-14.



Fig. 6. 1-14. Floppy disk and ECG connector

3. Pull out the Floppy disk drive and if necessary remove the ECG module from it.
4. Replace the Floppy disk drive and reverse the dismantling procedures.

6.1.5. Replacing the ECG module

Remove the electronic cassette as described in section 6.1.1 Removing the Electronic Cassette.

Remove the metal plate described in section 6.1.2 Getting access to the floppy disk drive.

Remove the single module (if installed) as described in section 6.1.3 Dismantling and Reassemble Procedures.

Remove the Floppy disk drive as described in 6.1.4 Replacing the Floppy disk drive.

1. Unscrew the three screws (M3×6) which holds the ECG module fixed to the floppy disk drive, see Fig. 6. 1-15.

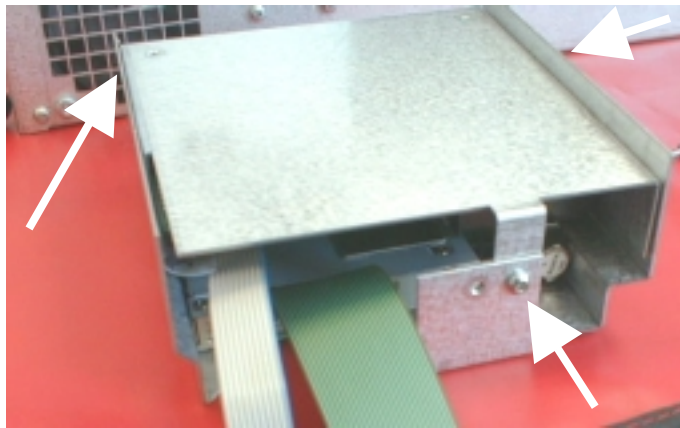

Fig. 6. 1-15. Screws fixing the ECG module

2. Remove the ECG module.
3. Replace the ECG module and reverse the dismantling procedures.

6.1.6. Replacing the Power Supply

Remove the electronic cassette as described in section 6.1.1 Removing the Electronic Cassette. Remove the metal plate described in section 6.1.2 Getting access to the floppy disk drive.

1. On units with PC Back-end the power, ground and power control cable must be removed, see Fig. 6. 1-16.

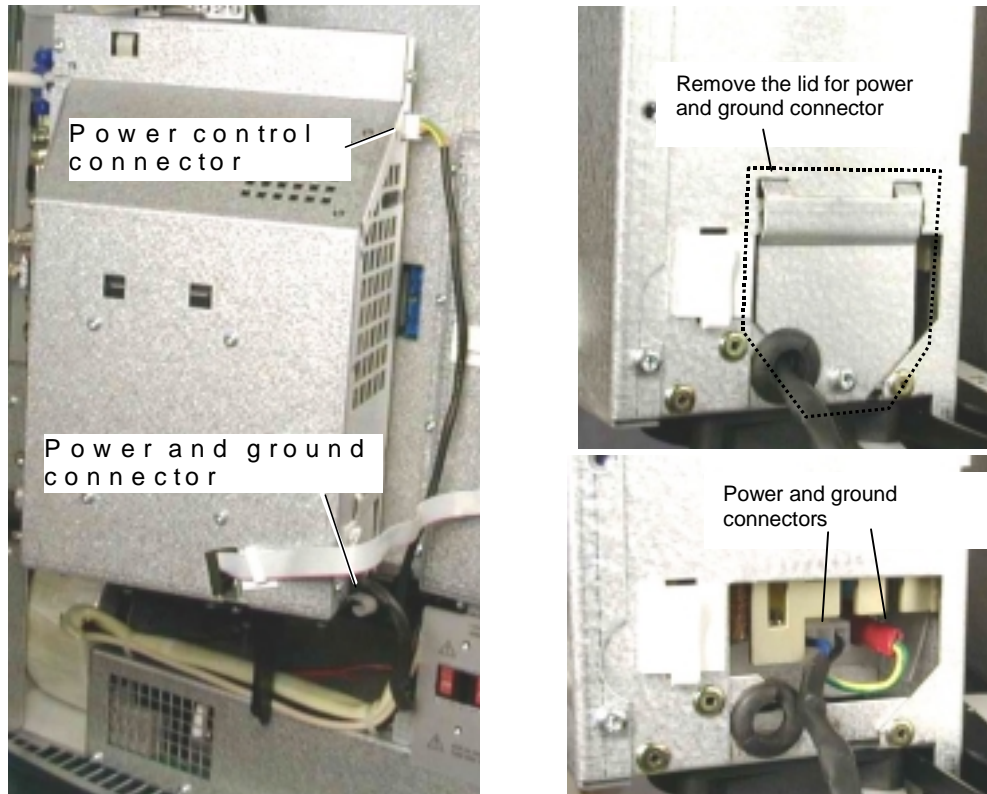

Fig. 6. 1-16. Remove the Power, Ground, and Power control connectors

2. Place the electronic cassette on the side and unscrew the seven screws (M3×6), see Fig. 6. 1-17.



Fig. 6. 1-17. Screws holding the Power Supply

3. Carefully slide out the Power Supply and disconnect the connector on the Motherboard, see Fig. 6. 1-18.

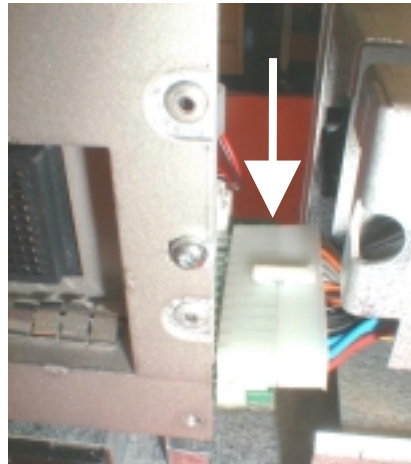

Fig. 6. 1-18. Power Supply connector on the Motherboard

4. Replace the power supply and reverse the dismantling procedure.
- ! 2101 only → 5. If necessary adjust the height of the image on the monitor, see Section 5 Monitor Adjustment.

6.1.7. Replacing the Fans

Remove the electronic cassette as described in section 6.1.1 Removing the Electronic Cassette.

Remove the Power Supply as described in section 6.1.2 Removing the Electronic Cassette.

4. Disconnect the two connectors from the Motherboard, see Fig. 6. 1-19.
5. Cut the strap fixing the cable, Fig. 6. 1-19
6. Unscrew the three screws (M3×10) on each fan and remove the fans, see Fig. 6. 1-19.

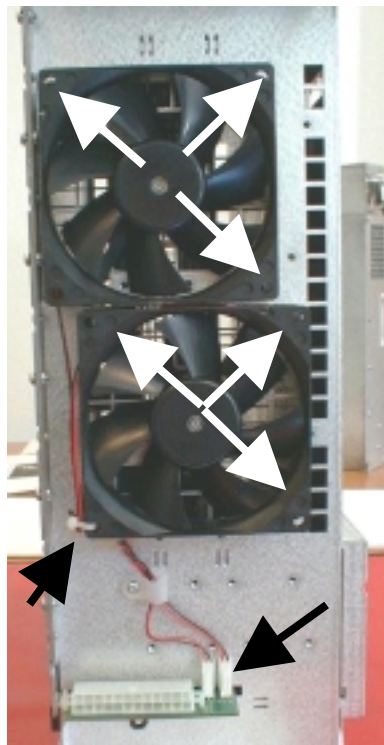



Fig. 6. 1-19. Connectors, strap, and screws for the two fans

6.1.8. Getting access to the PC boards

Remove the electronic cassette as described in section 6.1.1 Removing the Electronic Cassette.

1. Unscrew the seven screws (M3×6) on the cassette, see Fig. 6. 1-20 (marked ).
2. Loosen the seven screws (M3×6) on the cassette, and remove the metal plate covering the PC boards, see Fig. 6. 1-20 (marked ).

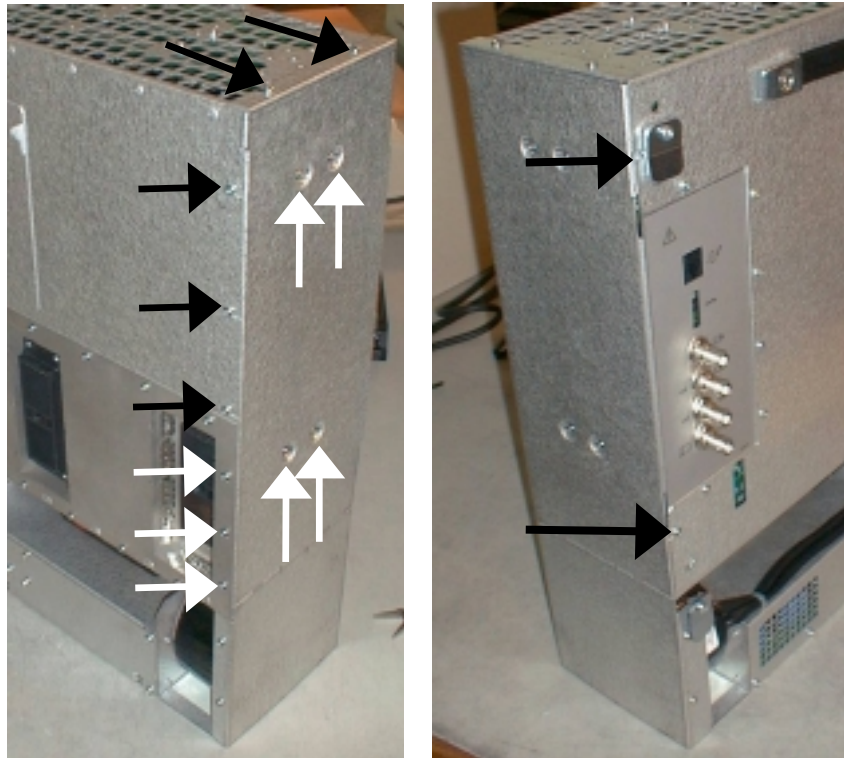

Fig. 6. 1-20. Screws holding the metal cover for the PC boards

6.1.9. Replacing the Front-end board

Remove the electronic cassette as described in section 6.1.1 Removing the Electronic Cassette.

Remove the floppy disk drive cover as described in section 6.1.2 Getting access to the floppy disk drive.

Get access to the PC boards as described in section 6.1.8

1. Unscrew the 12 screws and remove the transducer connector cover metal plate, see Fig. 6. 1-21.

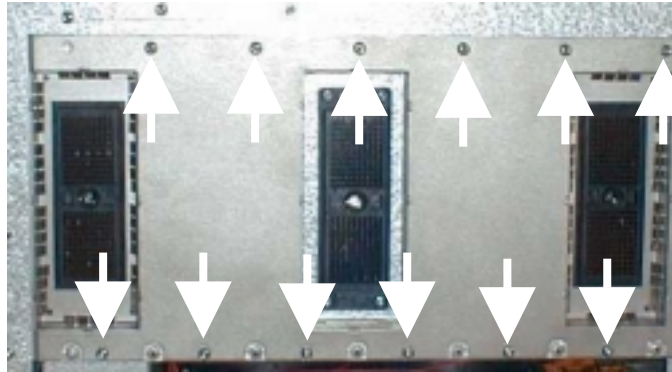

Fig. 6. 1-21. Screws on transducer connector cover plate

2. Remove the PCB fixation piece, see Fig. 6. 1-22.

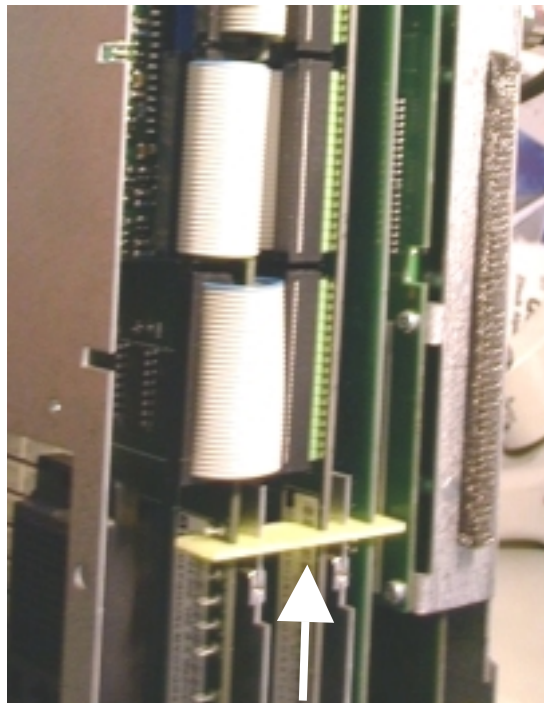

Fig. 6. 1-22. PCB fixing piece

- Slide out the Delay board approx. 5 cm and disconnect the three(2101)/four(2102) connectors on the multi-cables going to the Front-end board, see Fig. 6. 1-23.

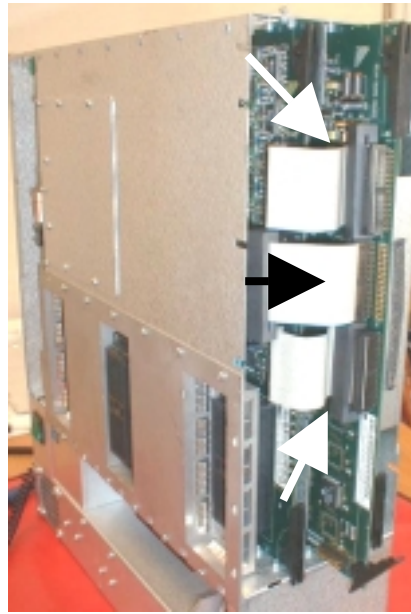

Fig. 6. 1-23. Connectors on Delay board

- Slide out the Front-end board.
- Install the new Front-end board and reverse the dismantling procedures.

6.1.10. Replacing the Delay board

Remove the electronic cassette as described in section 6.1.1 Removing the Electronic Cassette and get access to the PC boards as described in section 6.1.8

- Remove the PCB fixing piece, see Fig. 6. 1-22.
- Slide out the Delay board approx. 5 cm and disconnect the three(2101)/four(2102) connectors on the multi-cables going to the Front-end board, see Fig. 6. 1-23.
- Slide out the Delay board.
- Install the new Delay board and reverse the dismantling procedures.

6.1.11. Replacing the Doppler board

Remove the electronic cassette as described in section 6.1.1 Removing the Electronic Cassette and get access to the PC boards as described in section 6.1.8

- Remove the PCB fixing piece, see Fig. 6. 1-22.
- Slide out the Doppler board.
- Install the new Doppler board and reverse the dismantling procedures.

6.1.12. Replacing the Core board assembly

If possible save the user setups on a floppydisk.

Remove the electronic cassette as described in section 6.1.1 Removing the Electronic Cassette.

Get access to the PC boards as described in section 6.1.8.

1. Unscrew the six screws (M3×6) on the Core board connector plate, see Fig. 6. 1-24.

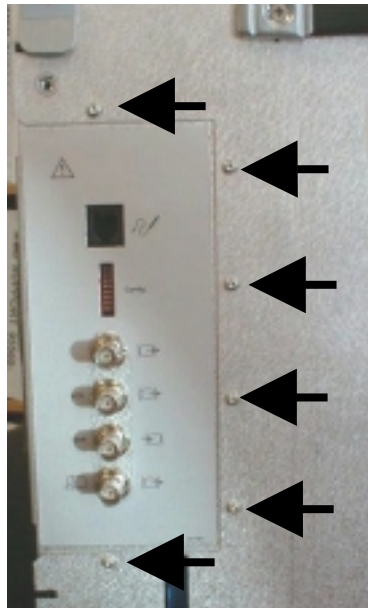

Fig. 6. 1-24. Screws on Core board connector plate

2. If the PC Back-end is installed then disconnect the video cable from the video board.
3. Slide out the Core board.
Note ! Be careful when sliding out the board ! Take care that the Coil on the board does not catch the screw holding the metal plate, see Fig. 6. 1-25 !

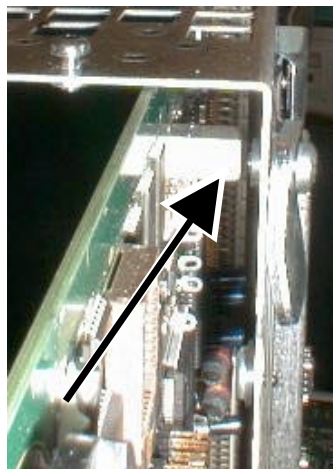
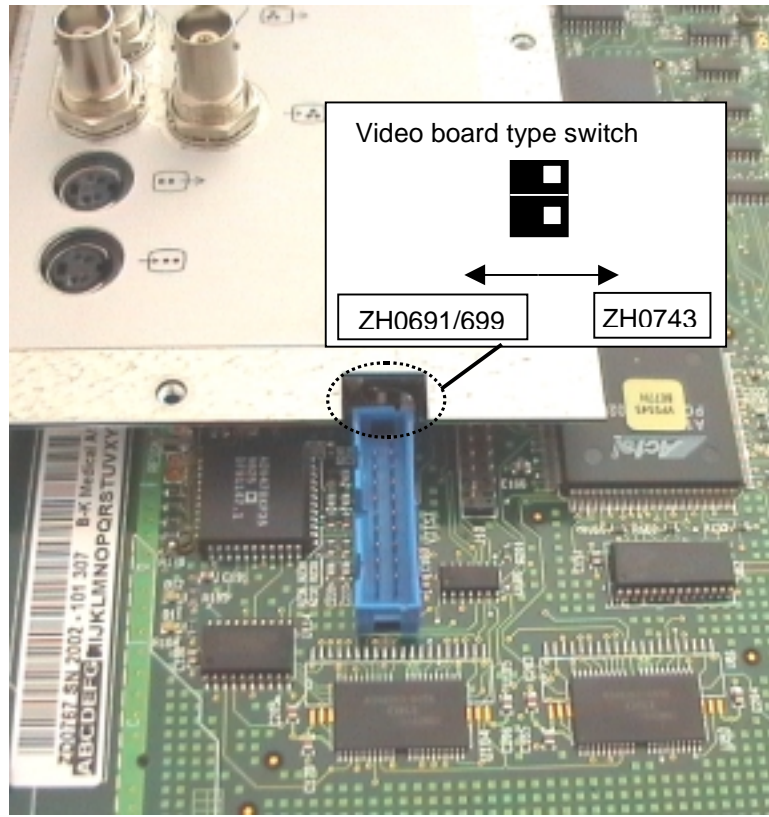

Fig. 6. 1-25. Coil on Core board !

4. Before installing the new Core board check that the video switch has been set correct, see below. Note – This is only applicable for Core board type ZD0767 used in 2102 Hawk !



5. Install the new Core board and reverse the dismantling procedures.
6. Set the clock on the system to the right time and date. Refer to the user guide.
7. If another language than English should be the default then load the Language disk.
8. If a preferred set of user setups are available then load then from the floppy disk drive.

6.1.13. Replacing the Motherboard

Remove the electronic cassette as described in section 6.1.1 Removing the Electronic Cassette.

Get access to the PC boards as described in section 6.1.8.

Remove the Power supply as described in section 6.1.5 Dismantling and Reassemble Procedures.

Remove the Front-end - , the Delay - , the Doppler(2102 only) - and then Core board as described in section 6.1.9, 6.1.10, 6.1.11, and 6.1.12.

1. Remove the two shielding plates from the cassette by unscrewing the four screws (M3×10) and slide out the plates, see Fig. 6. 1-26.



Fig. 6. 1-26. Shielding plate screws

- ! 2102 only !** → 2. Disconnect the connector from the Loud-speaker as shown in

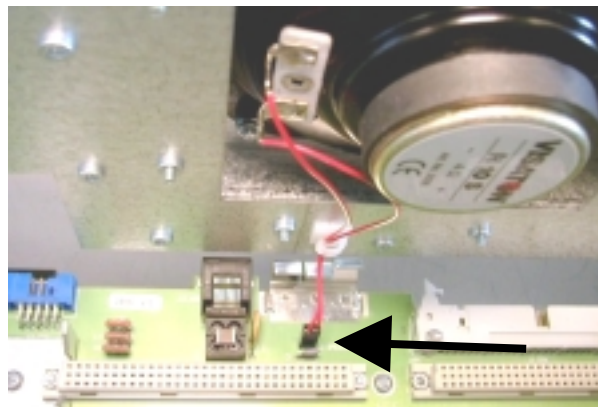

Fig. 6. 1-27. Loudspeaker connector on Motherboard

3. Unscrew the eight screws (six M3×6 and two M3×8) as shown in Fig. 6. 1-28.

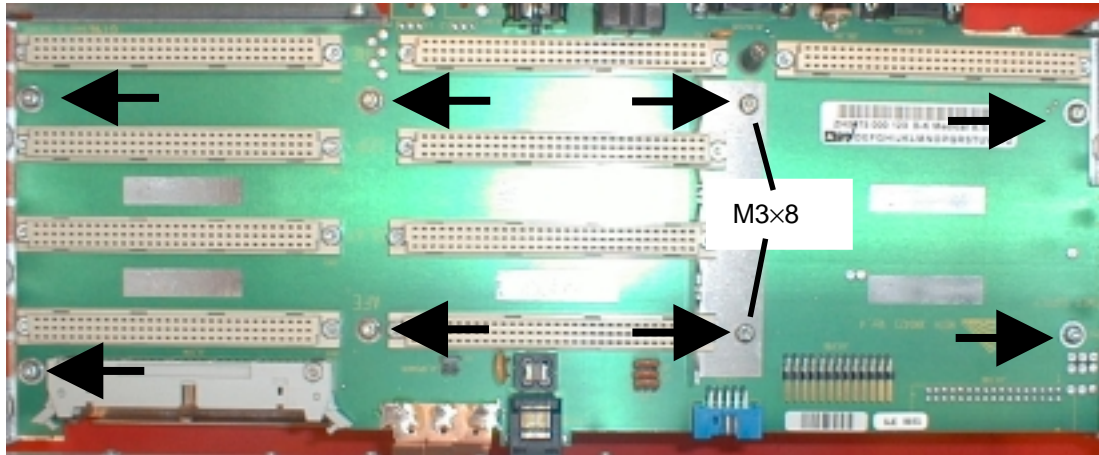

Fig. 6. 1-28. Screws holding the Motherboard

4. Disconnect the two connectors from the fans, see Fig. 6. 1-29.

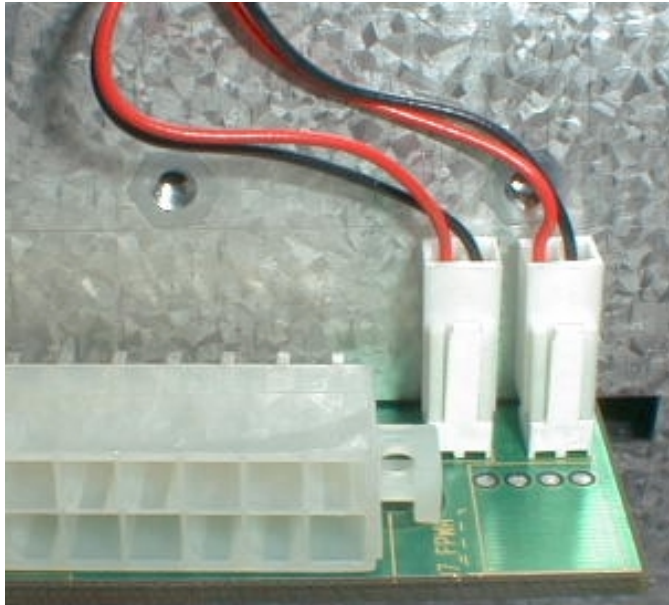

Fig. 6. 1-29. Plugs from the fans

5. Slide out the Motherboard.
6. Install the new Mother board and reverse the dismantling procedures.

6.1.14. Removing the keyboard

1. Disconnect the keyboard cable, see Fig. 6. 1-30.



Fig. 6. 1-30. Keyboard connector

2. Tilt up the keyboard and lift the keyboard up, see Fig. 6. 1-31.



Fig. 6. 1-31. Tilt the keyboard and lift it up

This page is left blank intentionally

6.1.15. Getting access to the inside of the keyboard

Remove the keyboard as described in section 6.1.14.

1. Disconnect the keyboard cable on the bottom of the keyboard.
2. Unscrew the nine screws and lift off the bottom of the keyboard.

6.1.16. Replacing the trackball

Remove the keyboard and get access to the keyboard interior as described in section 6.1.14.

1. Disconnect the cable from the Potentiometer board, see Fig. 6. 1-32.
2. Unscrew the two nuts and remove the trackball, see Fig. 6. 1-32.

6.1.17. Removing the potentiometer module

Remove the keyboard and get access to the keyboard interior as described in section 6.1.14.

1. Disconnect the four cables from the Potentiometer board (Gain board, Keyboard, Keyboard light, Trackball), see Fig. 6. 1-32.
2. Unscrew the six screws and remove the board, see Fig. 6. 1-32.

6.1.18. Removing the Gain board

Remove the keyboard and get access to the keyboard interior as described in section 6.1.14.

1. Disconnect the cable from the Potentiometer board, see Fig. 6. 1-32.
2. Unscrew the three screws and remove the board, see Fig. 6. 1-32.

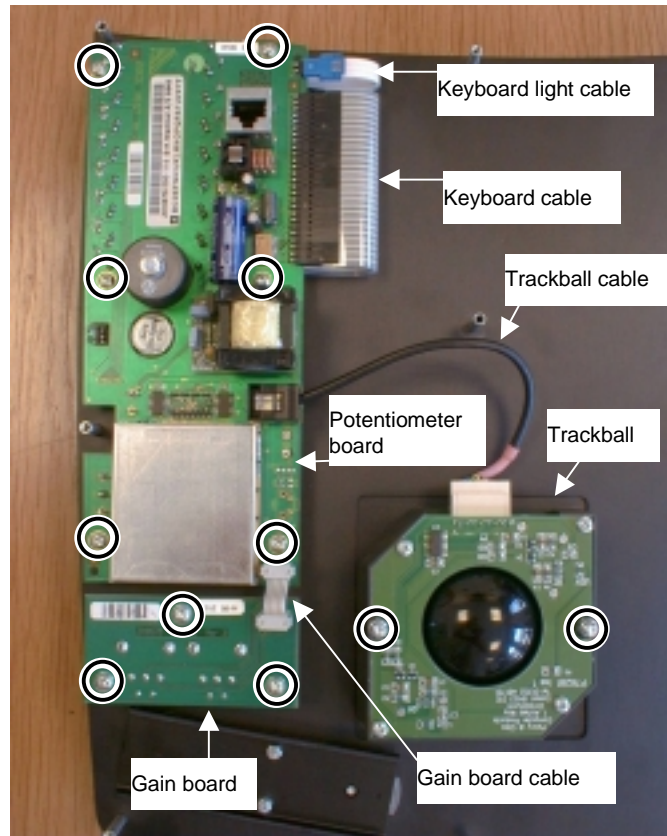
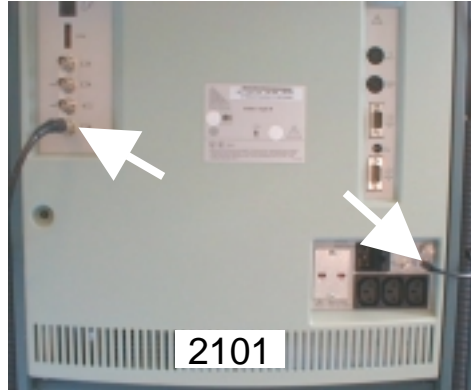
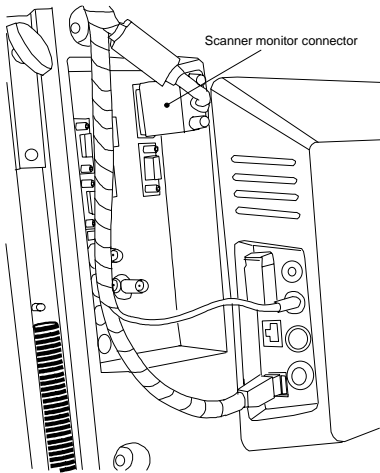

Fig. 6. 1-32. Items attached to the back of the keyboard

6.1.19. Replacing the monitor

1. Disconnect the video and the power connector from the monitor on the back of the scanner, see Fig. 6. 1-33.



2101/02EXL

Fig. 6. 1-33. Video and Power connector from the monitor

2. Remove the two side bar covers on top of the two sidebars, see Fig. 6. 1-34.

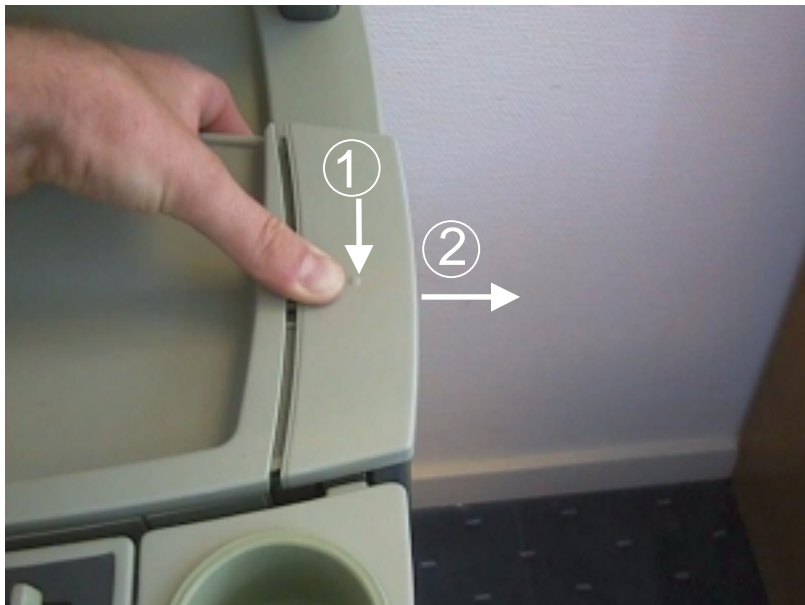

Fig. 6. 1-34. Remove the side bar cover

3. Slide up the monitor assembly, remove it from the trolley and position it up side down.

4. Remove the cables from the cable tubes, see Fig. 6. 1-35.



Fig. 6. 1-35. Remove the cables from the cable tube

5. Unscrew the four screws (thread forming 4×8) and remove the metal plate, see Fig. 6. 1-36.



Fig. 6. 1-36. Screws to be removed

- Slide out the two cable covers from the monitor base assembly, see Fig. 6. 1-37



Fig. 6. 1-37. Cable covers on monitor base assembly

- Unscrew the four screws (thread forming 4×8) and remove the metal plate, see Fig. 6. 1-38.



Fig. 6. 1-38. Screws on monitor base plate

8. Unscrew then four screws (M4×10) and remove the monitor ,see Fig. 6. 1-39.

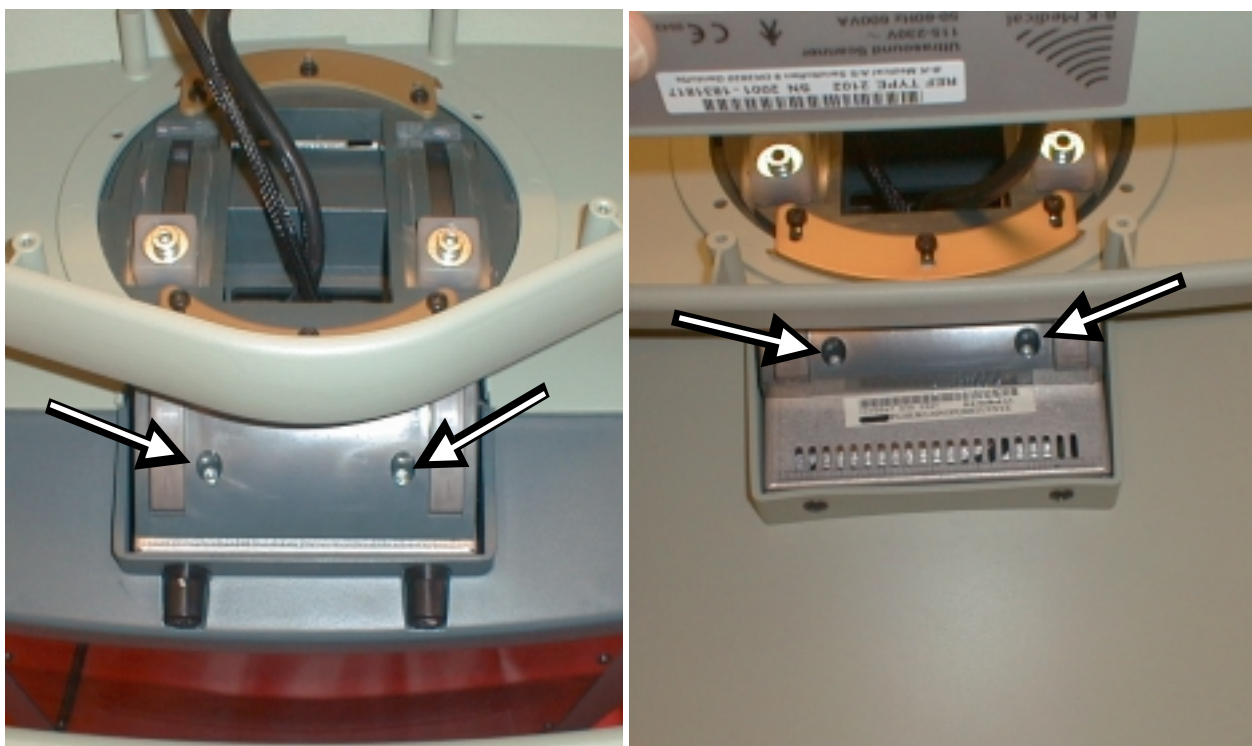

Fig. 6. 1-39. Screws holding the monitor

9. Replace the monitor and reverse the dismantling procedures.

- ! 2101 only !** →
10. After the replacement of the monitor check the height of the image and if necessary adjust it according to the procedure in section 5.

6.1.20. Getting access to the interior of monitor for adjustment (10", 12" and 14")

1. Unscrew the four screws (M4×12) on the back of the monitor and slide off the back cover, see Fig. 6. 1-40.

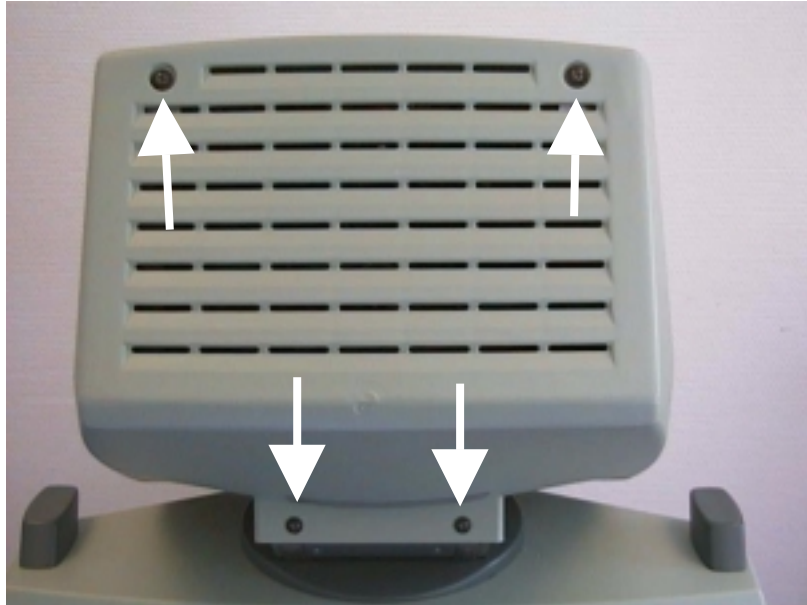

Fig. 6. 1-40. Screws on monitor back

! 2101 only ! →

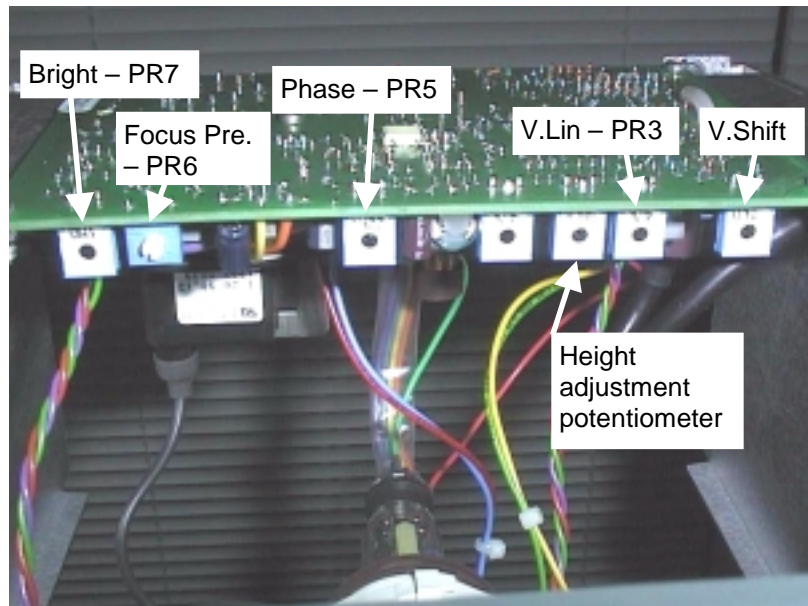

Fig. 6. 1-41. Adjustments potentiometers in the 2101 monitor

! 2102 only ! → Unscrew the eight screws (M4) on the top holding the deflection board. Note that one has a tooth washer. Pull up the board slightly to gain access to the potentiometers.

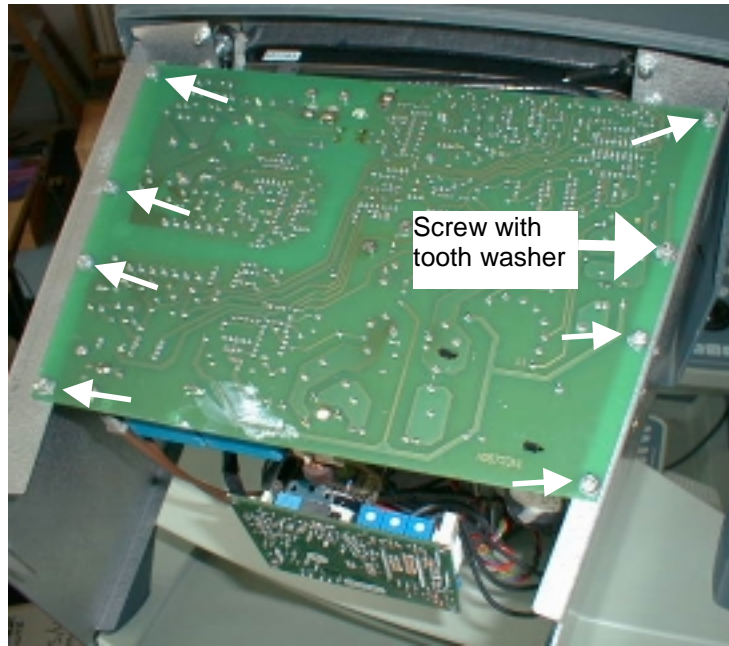

Fig. 6. 1-42. Screws to remove to get access to the adjustment potentiometers

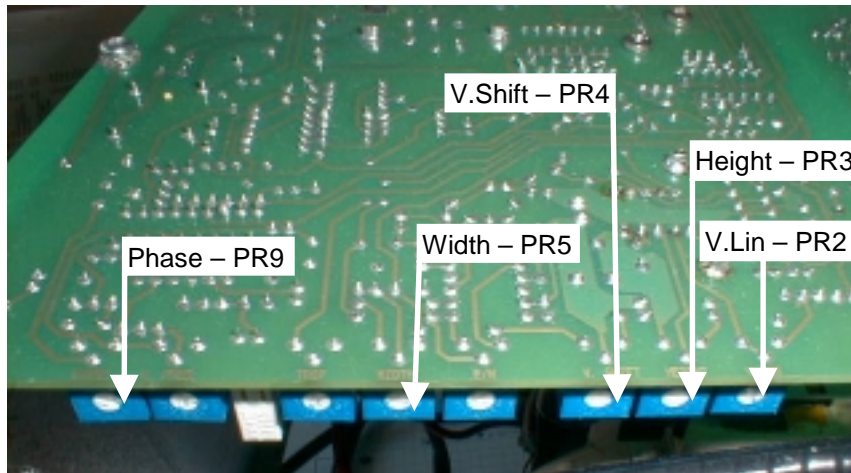

Fig. 6. 1-43. Adjustments potentiometers in the 2102 monitor

! 2102XDI only ! →

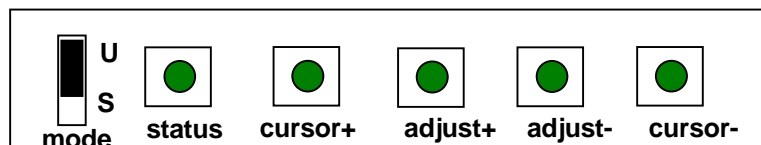

Fig. 6. 1-44. The Adjustments buttons inside the 14" monitor

6.1.21. Getting access to the PC Back-end

1. Remove the back cover of the scanner
2. Unscrew the 14 screws holding the PC Back-end lit, see fig. 6.1-45.

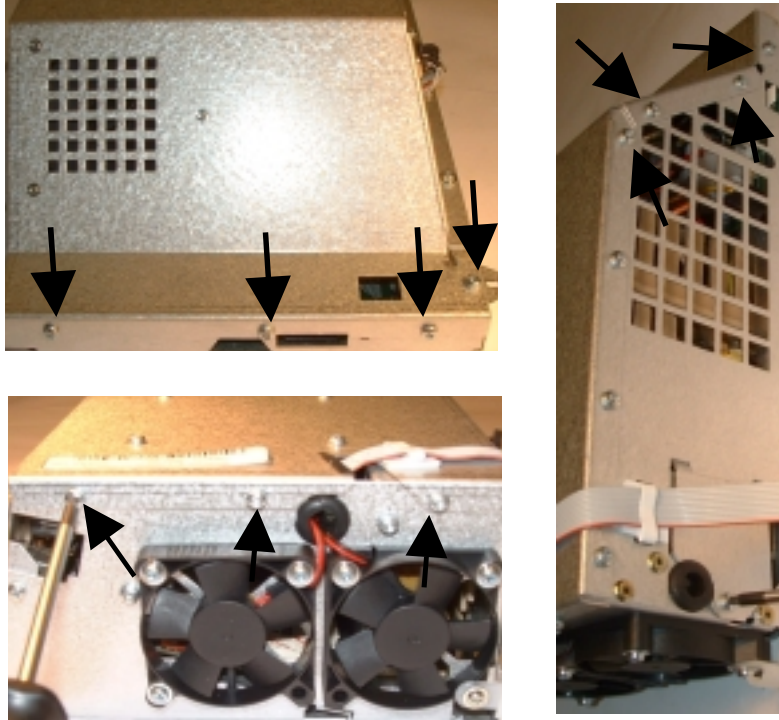

Fig. 6. 1-45. Screws holding the lit

3. Carefully lift off the lit, disconnect the cable to the harddisk and remove the loudspeaker from the lit, see 6.1-46. Place the loudspeaker at the side of the cassette.



Fig. 6. 1-46. Screws holding the loudspeaker

6.1.22. Remove the power supply

1. Unscrew the screw at the bottom holding the power supply, see 6.1-47.
2. Disconnect the 2 connector attached to the connection board and remove the power supply



Fig. 6. 1-47. Screws holding the loudspeaker

6.1.23. Remove the frame grabber

1. Loosen the screw holding the power supply, see 6.1-47
2. Unscrew the two screws holding the frame grabber
3. Carefully lift up the frame grabber
4. Disconnect the connector attached to the back of the frame grabber board, see 6.1-48

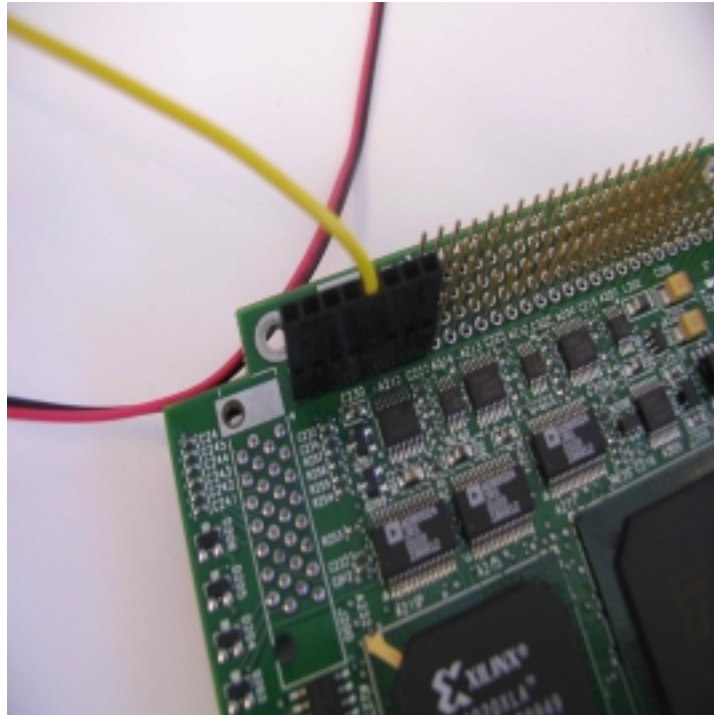

Fig. 6. 1-48. Connector on the back of the frame grabber

6.1.24. Remove the MCM boards

1. Remove the frame grabber to get access to the MCM boards.
2. Unscrew the 3 screws holding the MCM control board, see 6. 1-49.

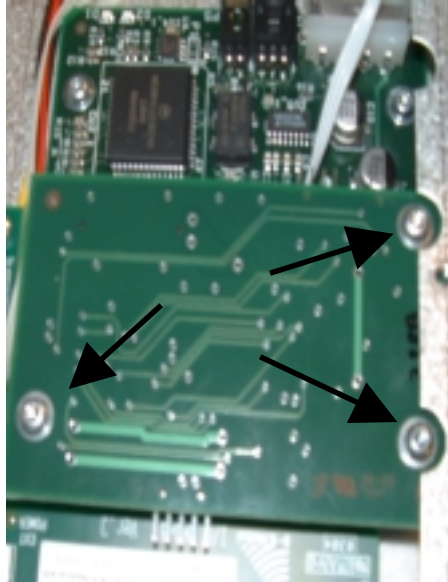

Fig. 6. 1-49. Screws holding the top MCM board

3. Unscrew the 2 screws and 3 spacers holding the MCM board, see 6. 1-50.

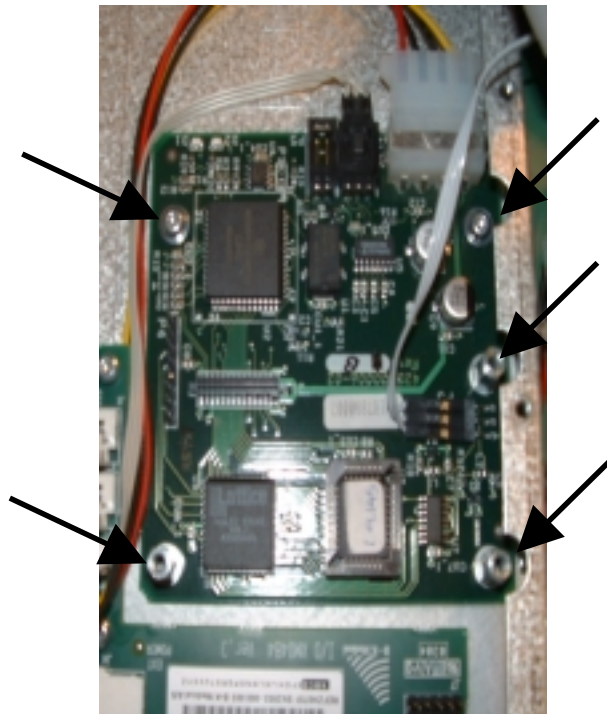
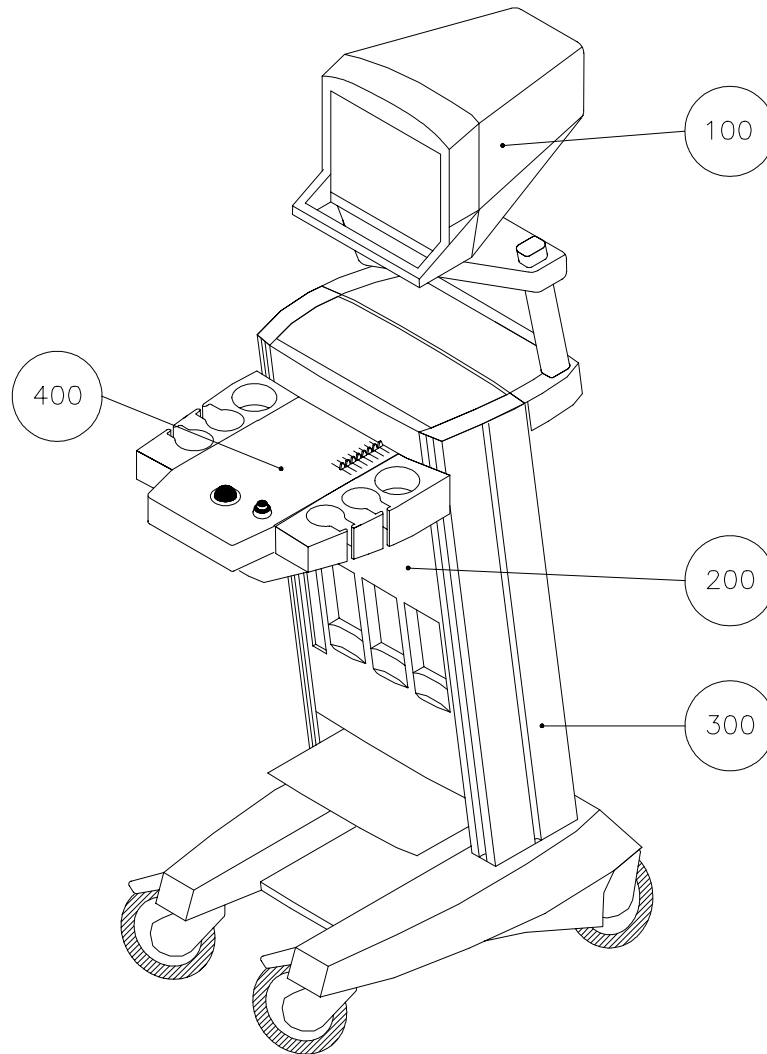

Fig. 6. 1-50. Screws holding the top MCM board

This page is left blank intentionally

6.2. Exploded Views

6.2.1. Overview (front)



ITEM	Description
100	Monitor
200	Cassette
300	Trolley
400	Keyboard

6.2.2. Monitor assembly exploded view

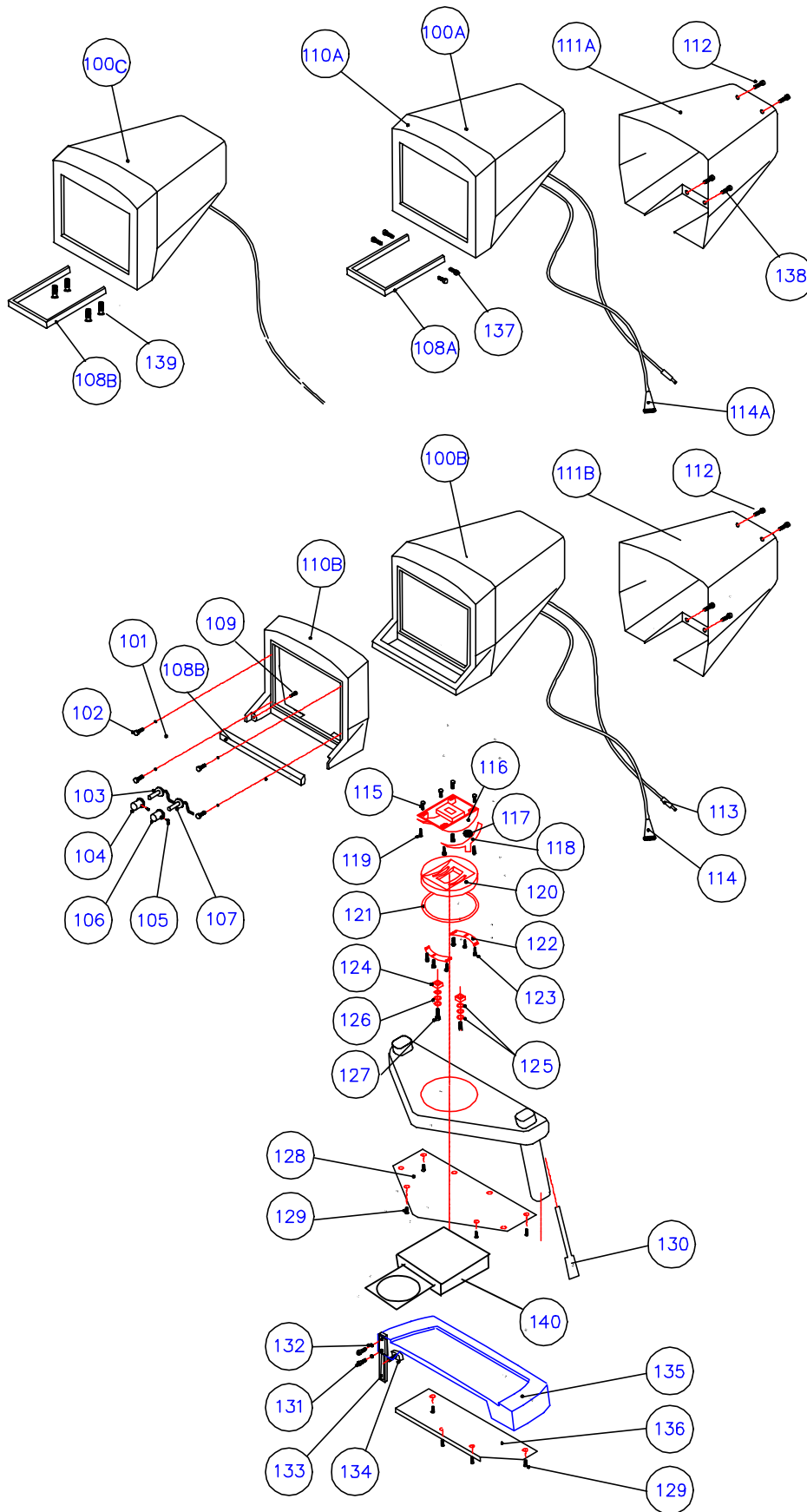

6.2.3. Monitor assembly part list

Item no.	Part no.	Quantity	Description
100A	ZV0060	1 (2102XDI)	Monitor complete, 14" Col. (incl. of item 108-114)
100B	ZV0049	1 (2101)	Monitor complete, 12" B/W (incl. of item 101-127)
100B	ZV0050	1 (2102)	Monitor complete, 10" Col. (incl. of item 101-127)
100B	ZV0051	1 (2102)	Monitor complete, 12" Col. (incl. of item 101-127)
100C	ZV0065	1(2101/02EXL)	Monitor complete, 15"VGA(incl. of item 108-114)
101	SG0001	1	Anti-glare screen
102	YS9508	4	Screw for anti-glare screen
104	SN0212	1	Bottom Contrast
104	SN0217	1	Bottom contrast 14" monitor
105	YQ4003	2	Pivot screw
106	SN0214	1	Bottom Brightness
106	SN0218	1	Bottom Brightness 14" monitor
108A	DH0761	1 (2102XDI)	Monitor handle ZV0060
108B	DH0764	1	Monitor handle
108C	DH0846	1(2101/02EXL)	Monitor handle ZV0065
109	YQ9211	2 (2102XDI)	Screw for monitor handle
110A	DZ9774	1 (2102XDI)	14" Monitor front cover
110B	DZ2317	1 (2101/2)	12" Monitor front cover
110B	DZ9759	1 (2102)	10" Monitor front cover
111A	DZ9761	1 (2102XDI)	14" Monitor back cover
111B	DZ2316	1	10/12" Monitor back cover
112	YS9512	2-4	Screw for back cover
113	ZN0010	1 (2101)	Monitor Power cable for 2101
113	ZN0012	1 (2102)	Monitor Power cable for 2102
114	ZN0011	1 (2101)	Monitor video cable for 2101
114	ZN0013	1 (2102)	Monitor video cable for 2102
114A	ZN0019	1 (2102 XDI)	Monitor video cable for 2102 14" monitor
115	YS9352	4	Screw M3×8 thread forming
116	DZ9766	1	Tilting base
117	YJ3133	2	O-ring
118	DP0822	2	Slide
119	YT1410	4	Screw M4×10 Torx
120	DZ9767	1	Tilt seat
121	YO1626	1	Sliding ring
122	GU1708	2	Monitor fixing plate
123	YT1408	6	Screw M3×8 Torx
124	DP0811	2	Tilt stop
125	YO0687	4	Washer
126	YO0800	2	Spring washer
127	YQ2635	2	Screw
128	GV2436	1	Plate
129	YT4408	4	Screw 4×8 Torx
130	DD0540	2	Cable cover
131	YT7625	2 (on each)	Screw
132	YO9427	2 (on each)	Spring washer (included in ZN0008)
133	ZN0008	2	Position guide for monitor/keyboard
134	DH0765	1 (on each)	M6×20 (included in ZN0008)
135	DZ2314	1(2101)	Shelf for 2101
135	DC0609	1(2102)	Shelf for 2102
136	GV2435	1	Plate
137		4 (2102XDI)	screw for handle 14" monitor
138	YS9507	2 (2102XDI)	Screw for backcover 14" monitor
139	YM0335	6 (2101/02EXL)	screw for handle 15" monitor
140	ZN0041	1 (2102/02EXL)	CD RW (for PC Back-end option)

6.2.4. Cassette assembly exploded view

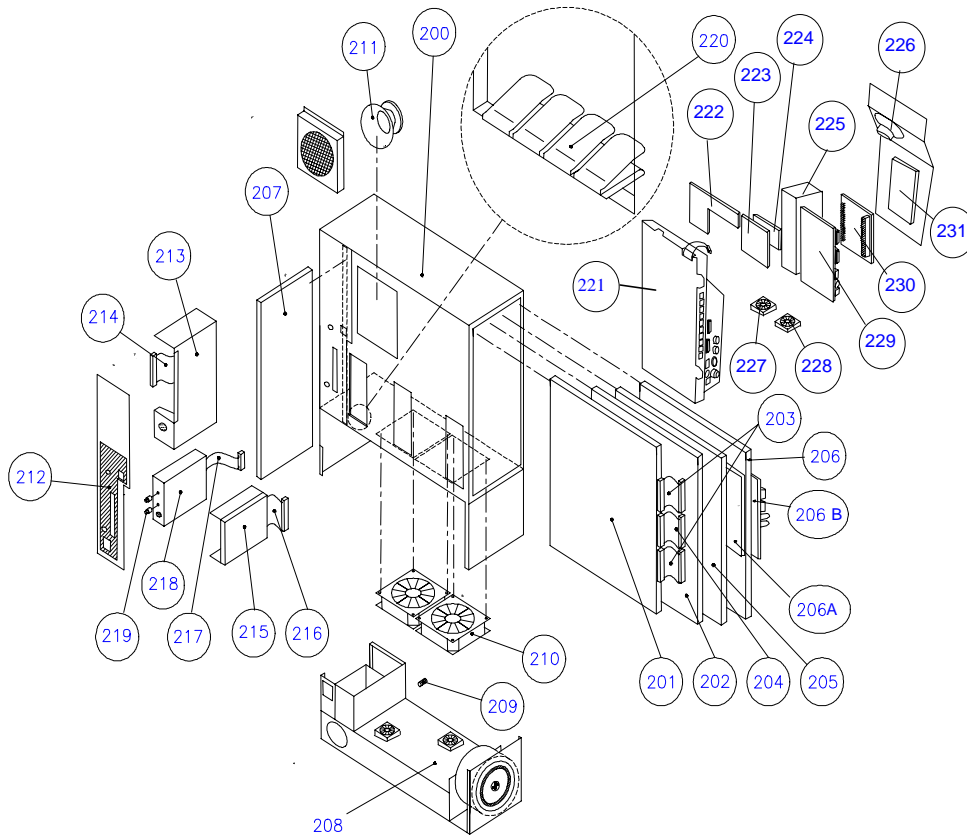

6.2.5. Cassette assembly part list

Item no.	Part no.	Quantity	Description
200	ZN2101	1	Cassette complete for 2101 (item201-216)
200	ZN2102	1	Cassette complete for 2102 (item201-216)
201	ZE0731	1(2101)	Front-end board for 2101
201	ZE0724	1(2102)	Front-end board for 2102
201	ZE0726	1(2101)	Delay board for 2101
202	ZE0725	1(2102)	Delay board for 2102
202	ZE0768	1(2102XDI)	Delay board for 2102XDI
202	ZE0774	1(210EXL)	Delay board for 2101EXL
202	ZE0772	1(2102EXL)	Delay board for 2102EXL
203	AQ1669	2	Cable from Front-end to Delay board
203	AQ1669	1(2101)	Cable from Front-end to Delay board
204	AQ1672	1(2102)	Cable from Front-end to Delay board
205	ZD0758	1(2102)	Doppler board for 2102
206	ZD0753	1(2101)	Core board for 2101
206	ZD0762	1(2102)	Core board for 2102 sw. vers. < 3.0
206	ZD0767	1(2102)	Core board for 2102 sw. vers. > 3.0
206	ZD0771	1(2101EXL)	Core board for 2101EXL
206	ZD0767	1(2102EXL)	Core board for 2102EXL
206A	ZH0691	1(2102)	Video Converter for 2102 Coreboard
206A	ZH0699	1(2102 PIP)	Video Mixer (PIP version) for 2102 Coreboard
206A	ZH0743	1(2101/02EXL)	Video Mixer for 2101/02EXL Coreboard

206B	ZH0692	1(2102)	Video Connector board for 2102 Coreboard
206B	ZH0722	1(2102 PIP)	Video Connector board (PIP version) 2102
206B	ZH0745	1(2101/02EXL)	Video Connector board 2101/02EXL
206C	ZH0744	1(2101/02EXL)	VGA Connector board 2101/02EXL
207	ZH0675	1(2101)	Mother board for 2101
207	ZH0695	1(2102)	Mother board for 2102
208	ZG0341	1	Power supply
208	ZG0348	1	Power supply for units with PC Back-end
209	VF0093	0-2	Fuse T 6.3A H, 250 V (for 220 V use)
209	VF0099	0-2	Fuse T 8A H, 250 V (for 115 V use)
210	UH1017	2	Fan
211	HP0041	1(2102)	Loudspeaker for 2102
212	SC1467	0-1	Floppy disk cover
	SC1468	0-1	Floppy disk and Single module cover
	SC1469	0-1	Floppy disk and ECG cover
	SC1470	0-1	Floppy disk, Single module, and ECG
213	ZH0709	0-1	Single module (incl. of AQ1668)
214	AQ1668	0-1	Cable for Single Module
215	UL0018	1	Floppy disk drive
216	AQ0590	1	Cable for floppy disk drive
217	AQ1670	0-1	Cable for ECG module
218	ZE0762	0-1	ECG module (incl. of AQ1670)
219	SN0179	0-2	ECG gain/off-set button
	DD0482	0-2	
	SV0056	0-2	
220	DM0295	10 (each con.)	Spring for transducer connector
	YT1306		Screw M3×6 Torx
	YT1308	2	Screw M3×8 Torx
	YS9507	3 (on each fan)	Screw for fan M4×10
	AO0366	0-1	ECG cable 3.5 m
	QB0041	1	Battery for Core board
221	ZN0377	1	PC Back-end complete
222	ZH0751	1	Connection board
223	ZH0752	1	MCM Base
224	ZH0753	1	MCM Motor Control
225	ZG0345	1	Power Supply for PC Back-end
226	ZN0432	1	Loudspeaker
227	ZN0431	1	Fan for PC Back-end
228	UH1019	1	Fan for CPU
229	ZN0042	1	Single Board PC
230	ZN0043	1	Frame Grabber incl. of connector
231	UL0023	1	Harddisk

6.2.6. Trolley assembly exploded view

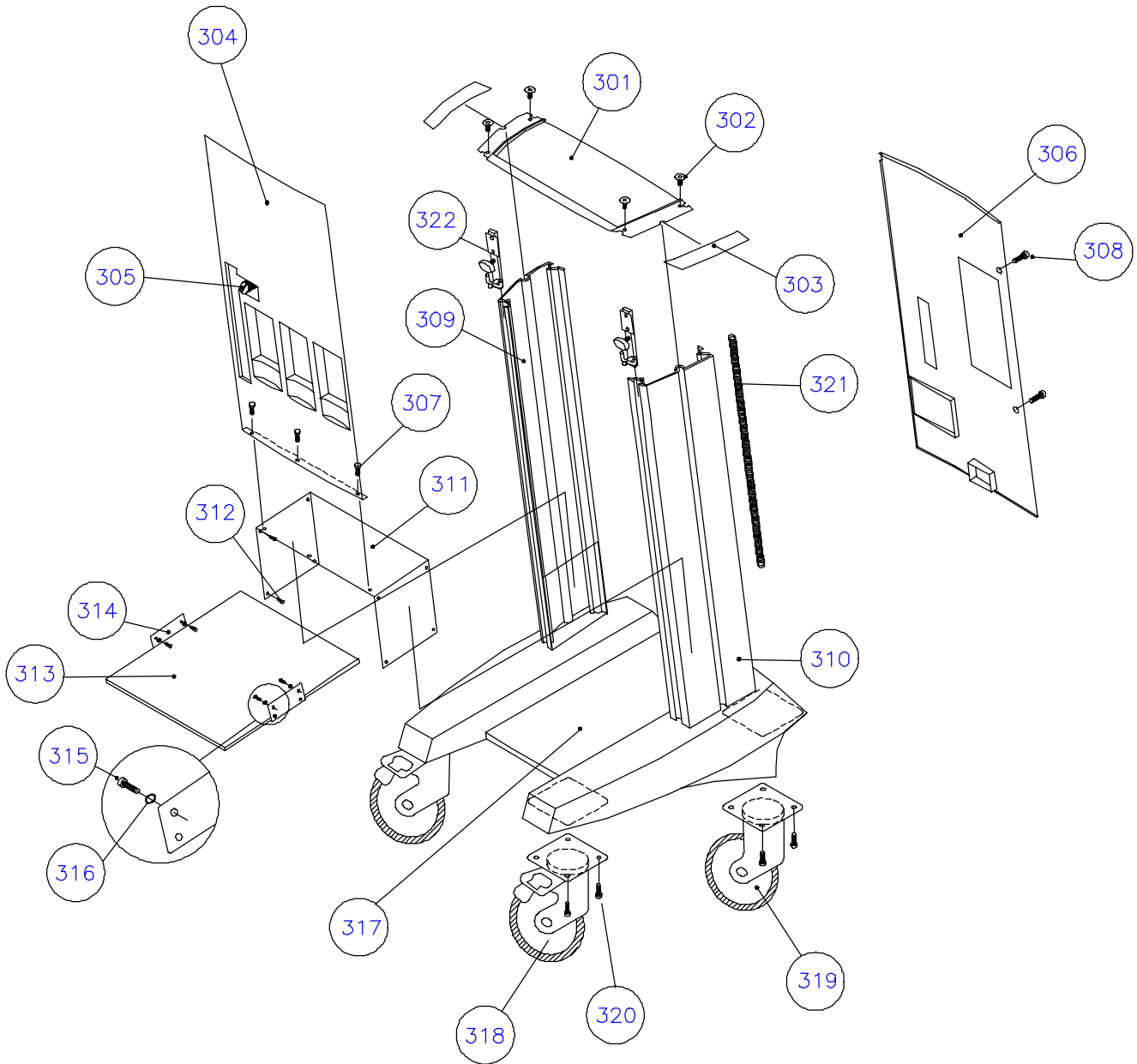

6.2.7. Trolley assembly part list

Item no.	Part no.	Quantity	Description
301	DZ9750	1	Trolley top plate
302	YS0823	4	Screw for top plate
303	DZ9721	2	Side bar covers
304	DZ9751	1	Front cassette cover
305	DH0678	1	Cable holder for front cassette cover
306	DZ9752	1	Back cassette cover
307	YS9509	3	Screw for front cassette cover
308	YT1408	2	Screw for back cassette cover
309	DK1267	1	Side bar left
310	DK1268	1	Side bar right
311	GV2413	1	Shelf for electronic cassette
312	YT1408	8	Screw for electronic cassette shelf
313	GV2437	1	Shelf for VCR/printer
314	GV2451	2	Shelf mounting brackets
315	YS9507	8	Screw for VCR/Printer shelf
316	YO0462	8	Washer for VCR/Printer shelf
317	DZ9758	1	Trolley base
318	DF7081	2	Front wheel with brake
318	DF7091	2	Front wheel with brake – conductive (optional)
319	DF7080	2	Rear wheel
319	DF7091	2	Rear wheel - conductive (optional)
320	YT1610	16	Screw for wheel
321	AF0912	0.44m (on each side)	Cable tube
322	ZN0008	2	Position guide for monitor/keyboard

6.2.8. Keyboard assembly exploded view

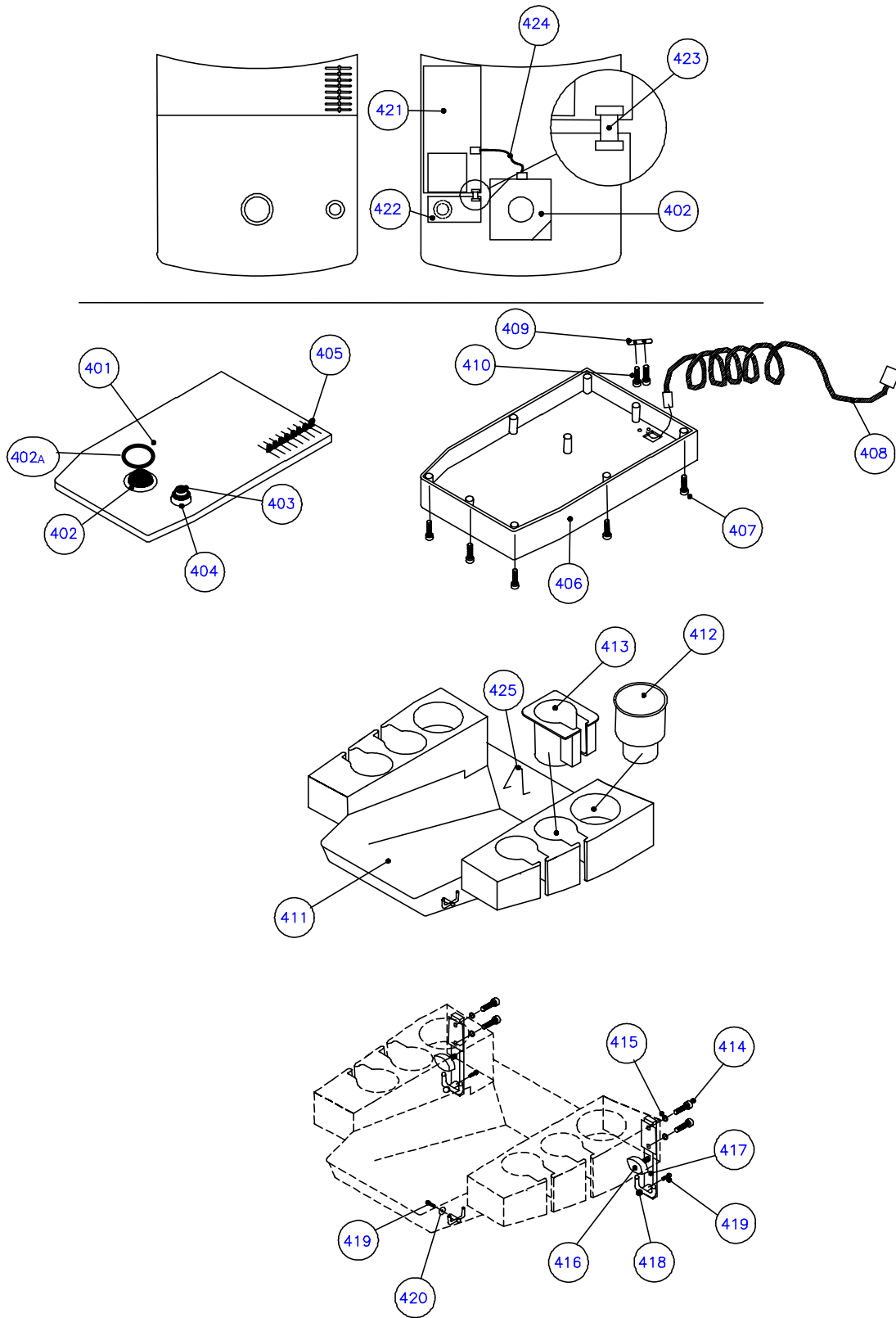

6.2.9. Keyboard assembly part list

Item no.	Part no.	Quantity	Description
400	ZN0006	1(2101)	Keyboard complete for 2101 (item 401-410)
400	ZN0009	1(2102)	Keyboard complete for 2102 (item 401-410)
401	NP0139	1(2101)	Keyboard for 2101
401	NP0140	1(2102)	Keyboard for 2102
402	NT0254	1	Trackball (Inclusive of Lip Seal Ring)
402A	YJ3150	1	Lip Seal ring for Trackball
403	SN0210	1	Gain button top
404	SN0209	1	Gain button lower
405	DP0888	8	Potentiometer button
406	DZ9748	1	Keyboard bottom cover
407	YT1310	9	Screw for keyboard bottom cover
408	AO0415	1	Keyboard cable
409	DV0469	1	Cable relief
410	YT2312	2	Screw for cable relief
411	ZN0007	1	Keyboard base (item 414 – 420)
412	DZ9754	2	Gel holder
413	DZ9755	4	Transducer holder
414	YT7630	2 (on each)	Screw (included in ZN0008)
415	YO9427	2 (on each)	Spring washer (included in ZN0008)
416	DH0765	1 (on each)	M6×20 (included in ZN0008)
417	ZN0008	2	Position guide for monitor/keyboard
418	DZ9262	4	Cable hook (not on ZN0008)
419	YT2416	4	Screw for cable hook (not on ZN0008)
420	DB3407	2	Washer for cable hook
421	ZH0676	1	Potentiometer board
422	ZH0678	1	Gain potentiometer board
423	AQ1665	1	Cable Potentiometer - Gain board
424	AO2016	1	Trackball cable
425	QA0228	1	Trackball adjusting tool

This page is left blank intentionally

Section 7

PREVENTATIVE MAINTENANCE

CONTENTS	PAGE
7.4. Introduction	7-2
7.5. Necessary Equipment.....	7-2
7.6. What to do.....	7-3

7.1. Introduction

The purpose of the Preventative Maintenance is to ensure the performance and stability over the years of use.

Note: The Preventative Maintenance should be performed once every year.

Preparation of the Preventative Maintenance is essential as it in most cases will take place at the hospital as part of a Continuity Agreement.

The Preventative Maintenance consists of eight steps. Some of these steps refer to specific sections in the Service Manual. If errors occur during the procedure go to TROUBLESHOOTING, Section 4.

7.2. Necessary Equipment

The equipment, necessary for a preventative visit is divided into 3 packages.

A: Parts necessary to ensure the performance and stability of the system.

Check in the Service Informations (Hot-Line) if there are any modifications to be done.

B: Parts necessary to meet customers complaints.

Before arranging the visit, check if the customer has any complaints and bring the necessary spare parts and tools to solve the problem.

C: Tools and equipment necessary to perform the Preventative Maintenance.

The only equipment necessary to perform the Preventative Maintenance is the equipment used in the Electrical Safety Test and phantoms for the Checking Procedure:

For the Checking Procedure:

Transducer Phantom, model 254 (B-K no.WQ 0973) for checking a 2101/2102 system equipped with Array- and Single Element Transducers.

Transducer Phantom, type 251 (B-K no. WQ0972) for checking a 2101/2102 system equipped with the Endosonic Probe 1850.

For the Electrical Safety Test:

Testers required:
Safety tester
HV Tester

High Voltage test plugs required:
WJ 0246 HV Test Plug for Mains
WJ 0287 HV Test Plug for ECG (optional)

High Voltage test adaptors required:
WB 1275 HV Test Adapter for Transducers (for BF array transducers)

Note: It is recommended to bring additionally the Static Control Service Kit, type 3M 8501 (B-K no. WQ0969) or similar in case one of the static sensitive PC Boards is to be removed from its location in the cassette.

7.3. What to do

1. Users Comments and Corrections

Check with the user that the system is operating satisfactorily. A number of malfunctions can be corrected by an set-up adjustment! If an error is obvious correct it at this state.

2. Modifications

In accordance with the Service Informations (HOT-LINE) perform modifications necessary to ensure performance and stability of the system.

3. Mobility

Check that the system moves freely and all wheels are turning.
Check that the monitor can be tilted up/down
Check that the trackball moves smoothly

Caution - Never add oil or grease to wheels or any other movable parts.

4. Fans inside the cassette

Remove the cassette from the 2101/2102. Connect a mains cable and turn on the unit. Check that both fans above the power supply rotates and check that the fan inside and the two fans on top of the power supply also rotates. Reassemble the scanner.

5. Fans inside the monitor on 2102XDI

Remove the back cover of the monitor. Check that the fan underneath the monitor rotates. Reassemble the monitor.

6. Checking Procedure

To verify proper operation of the main functions perform the CHECKING PROCEDURE, Section 3.

7. Peripherals

This is to verify the function of the video output and the peripherals used with the 2101/2102 System.

Take a picture/print and check the quality. If necessary adjust the peripheral using the original instruction manual.

8. Adjustment Procedure

If necessary, perform an adjustment of the Monitor using the ADJUSTMENT PROCEDURE, Section 5.

9. Electrical Safety Test

Verify that the system complies with IEC 60601-1 using the Electrical Safety Test, Section 1

This page is left blank intentionally

Section 8

THEORY OF OPERATION

CONTENTS	PAGE
8.1. Introduction.....	8-2
8.2. General Description	8-2
8.2.1. Configurations	8-3
8.2.2. Block Diagram	8-4
8.3. PC Board Description.....	8-6
8.3.1. Front End Board	8-6
8.3.2. Delay Board	8-8
8.3.3. The Incremental Analog Beamformer	8-9
8.3.4. Core board.....	8-12
CPU system.....	8-12
Real-time Scan Controller (RTSC)	8-12
8.3.5. Floppy Disk	8-13
8.3.6. The Doppler Board	8-14
8.3.7. Single input module.....	8-16
8.3.8. ECG module	8-17
8.3.9. Power Supply	8-18
8.3.10. Monitor	8-19
8.4. PC Backend.....	8-20
8.5. 2101/2 Test facilities.....	8-21

8.1. Introduction

This section describes the theory of operation of the Diagnostic Ultrasound System 2101, 2101EXL, 2102, 2102XDI, and 2102EXL

This description is divided into two separate sub-sections:

8.2. General Description

Supported by a complete block diagram, this section aims to give you an understanding of the interaction between modules, PC Boards and major function blocks. It explains briefly the main signal flow through the 2101/2102 system.

8.3 PC Board Description

This section provides an overall description of each PC Board, explaining the main function of all function blocks on the board. Furthermore the section contains a description of the ECG Input Module, the Single Transducer module, the PC backend, and the Monitor.

8.2. General Description

The following aims to give you a brief and easily read description of how the different modules and parts of the Diagnostic Ultrasound System 2101/2102 are related to each other and how they function together as a system. The complete block diagram shown on page 8-4 should be used for reference while reading this section.

8.2.1. Configurations

The scanners are equipped with the following boards/ subassemblies:

Front End board (AFE = Analog Front End)
 Core Board
 Video Board
 Video Connector Board
 Delay board (IAB = Incremental Analog Beamformer)
 Doppler Board (2102/2102XDI/2102EXL)
 Mother board (Back plane)
 Floppy Drive
 Power Supply
 Monitor
 Keyboard (subassembly)
 Potentiometer Board (part of keyboard)
 Gain Board (part of keyboard)
 Tracker Ball (part of keyboard)

As options the 2101/2102 system can be equipped with a Single Element Transducer Module, ECG Input Module and PC-Backend which enables 3D scanning. If these are installed the following boards/subassemblies will then also be present:

Single Element Transducer module
 ECG Module board
 PC-Backend (3D scanning) – ONLY on 2101EXL and 2102EXL !

The 2101/2102 system consists of an Analog/Digital cassette which holds all the PCB's and an attached Power Supply making the electronics fit in one cassette.

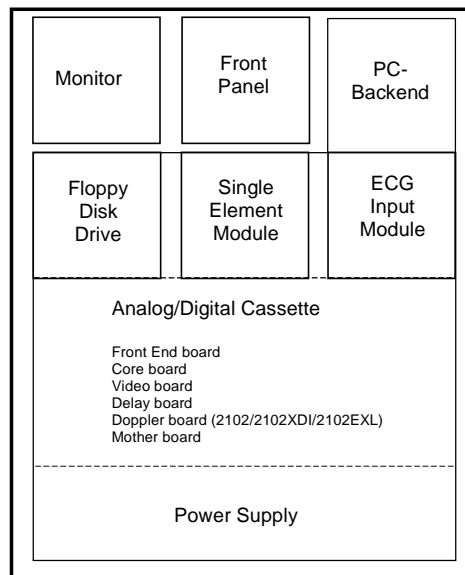

Fig. 8.2-1. Diagnostic ultrasound system 2101/2102

8.2.2. Block Diagram

The description of the PC Boards follows the signal flow in the 2101/2102 system. Refer to Fig. 8.2-2 2101/2102 Block Diagram

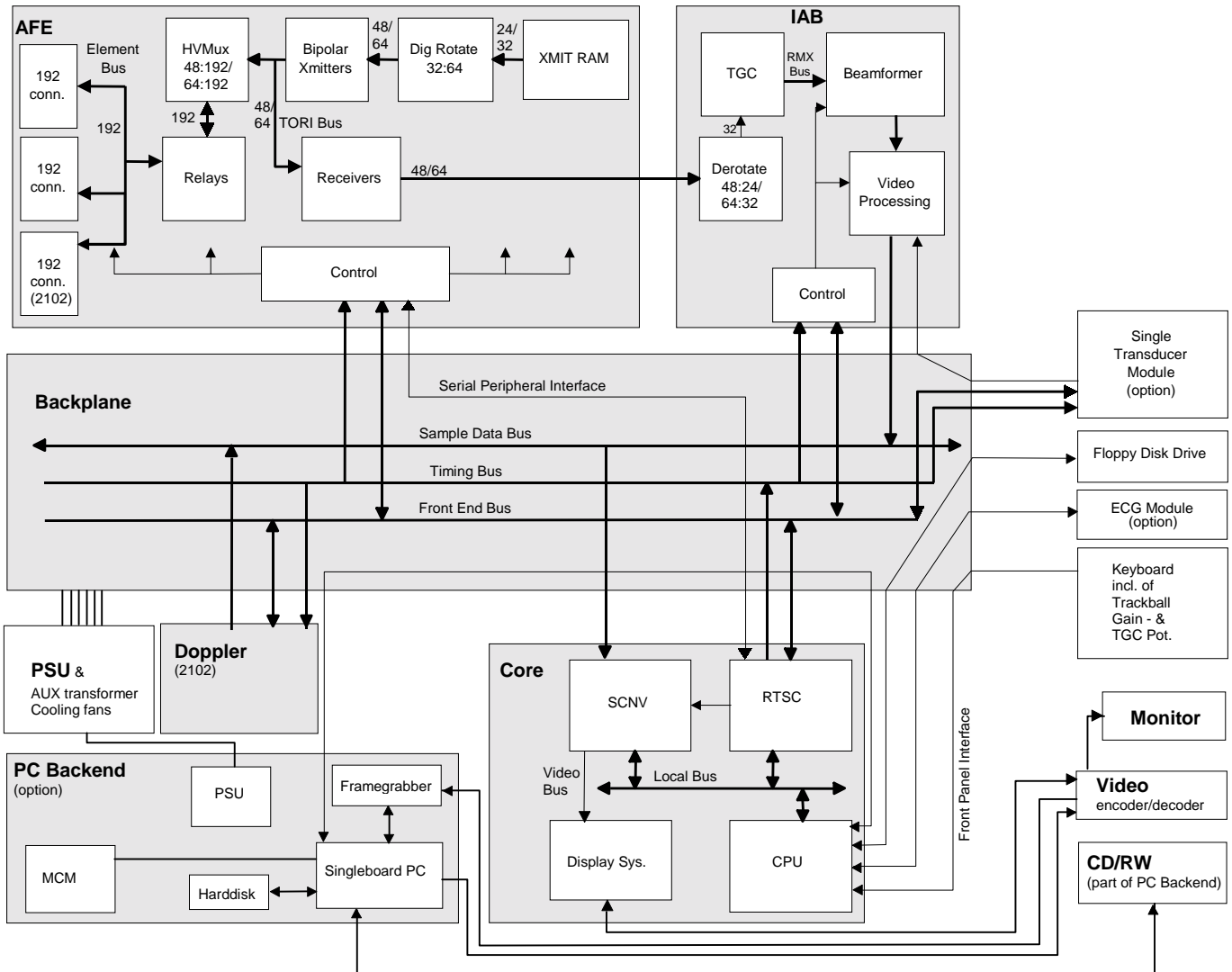

Fig. 8.2-2. 2101/2102 Block Diagram.

The signal path starts at the Front End Board where the transmit beam signal profile is generated. The beam profile is fed to a 48/64 channel transmit driver and then directed to the active transducer connection.

The echo signals are routed from the active transducer connection to the preamplifiers on the Front End board and then passed on to the Delay Board.

On the Delay board the signals are derotated and at the same time added together two by two according to their delay requirements to reduce the number of signal lines. The echo signals are filtered and delayed with different delays to convert the arc shape of the echo signals to a straight line. The signals are then added together to form a single signal representing the reflection from the scanned object. The analog signal is converted to an 8 bit digital signal which is led to the Core Board.

On the Core Board the digital signal is processed and converted into a composite video signal for use in the Monitor. Besides the scanning image the graphics are mixed into the video signal. The Core Board controls the signal flow through the system and the whole timing in respect to the active transducer. It also handles input/output to Keyboard, Light pen, ECG Input Module, and Floppy Disk drive.

The Doppler board interfaces to the analog output of the beamformer. Apart from the Analog Front End where demodulation and filtering takes place, the signal processing is digital. The "Quadrature" and "Phase" signals are digitized using a 12/16 bit A/D converter. The signal processing takes place using DSP's (Digital Signal Processors). Most of the CFM signal processing, wall filtering and auto correlation is performed in the CFM pre-processor. A CFM post-processor processes output data, Median Filter, interpolation and controls the transfer of CFM data to the Scanconverter. The Spectral Doppler processing, wall filter and FFT is performed by the spectral doppler processor.

8.3. PC Board Description

This section provides an overall description of each board, explaining the main function of all function blocks on each board.

8.3.1. Front End Board

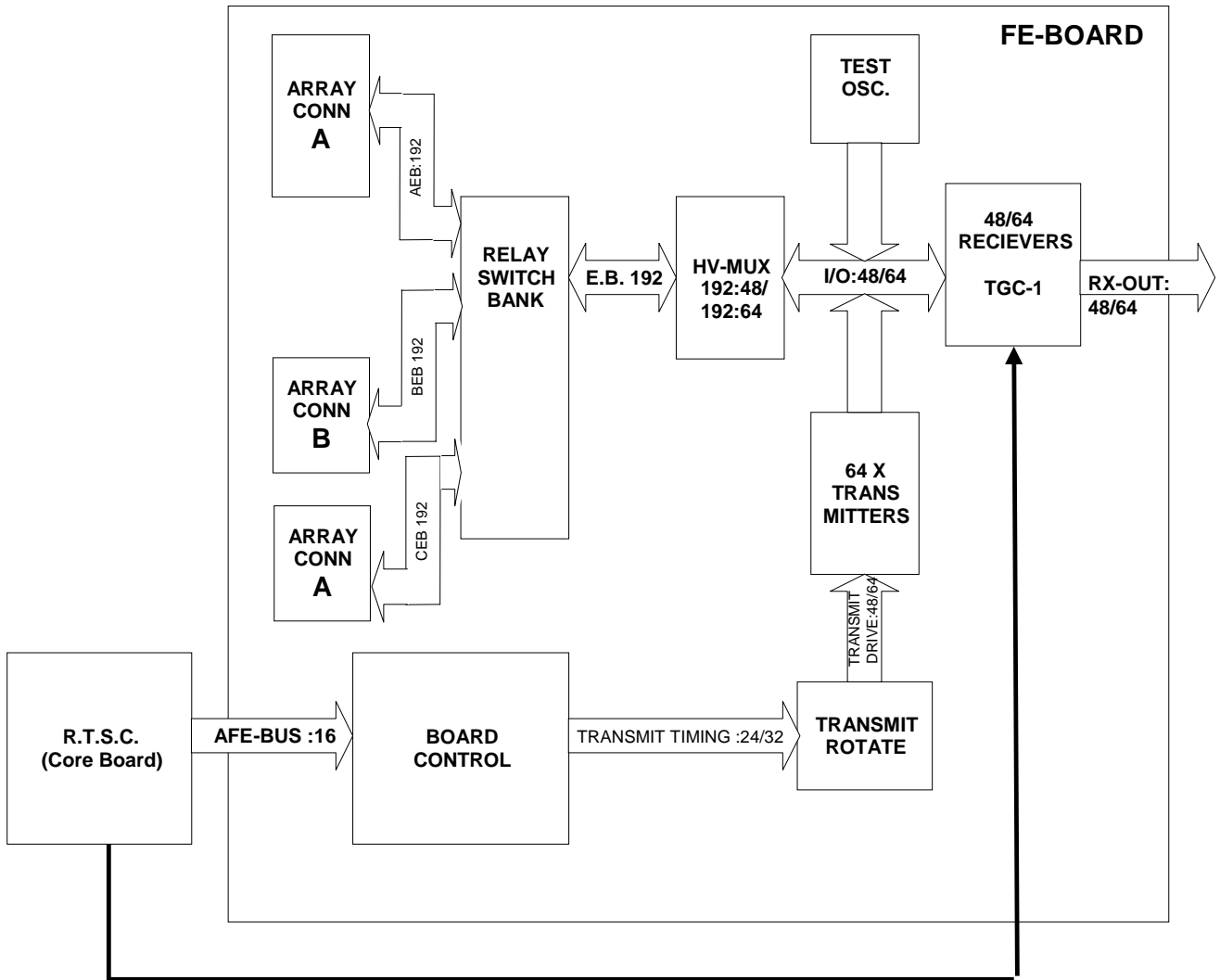

Fig. 8.3-1. Front end board

The Front end board consist of 2/3 array transducer connectors, a relay switch bank, a HV multiplexer, 48/64 receivers with preamplifiers and TGC, a board control system, a transmit rotate circuit, 48/64 transmit pulse amplifiers, and a test oscillator.

The array transducer connectors are 2/3 260 pole ZIF CANNON connectors for connection of array transducers with up to 192 elements. The relay switch bank switches between the two 192 line element buses (A, B and C), connecting the active transducer to the HV multiplexer.

The HV Multiplexer is used to selectively connect 48/64 of the 192 transducer elements to the receive - transmit system.

The Board control which is set up by the Core board holds the xmit-RAM (transmit timing) which is loaded with the beam profile of the active transducer. The 24/32 channels transmit timing data are sent to the Transmit rotate block where they are folded and rotated digitally. The resulting 48/64 channels (bits) pulses are then amplified in the Transmit amplifier and finally sent to the HV multiplexer. The output of the transmitters is controlled by a set of 8 bit D/A converters.

The Receiver circuit consist of 48/64 current preamplifiers and TGC stages driving the receive derotate multiplexer (on the Delay board). The TGC Amplifiers compensates for the attenuation of the ultrasound wave in human tissue. This is done in a voltage controlled amplifier by increasing the gain with time, that is the greater the depth of the echo signal the greater the degree of amplification.

The purpose of having 48/64 transmit/receive channels is to focus the ultrasound in one point; the focal point. The 48/64 echoes received by the 48/64 transducer crystals are therefore equivalent to one echo pulse received from the focal point.

The Front end board also holds a test oscillator used for fault finding.

8.3.2. Delay Board

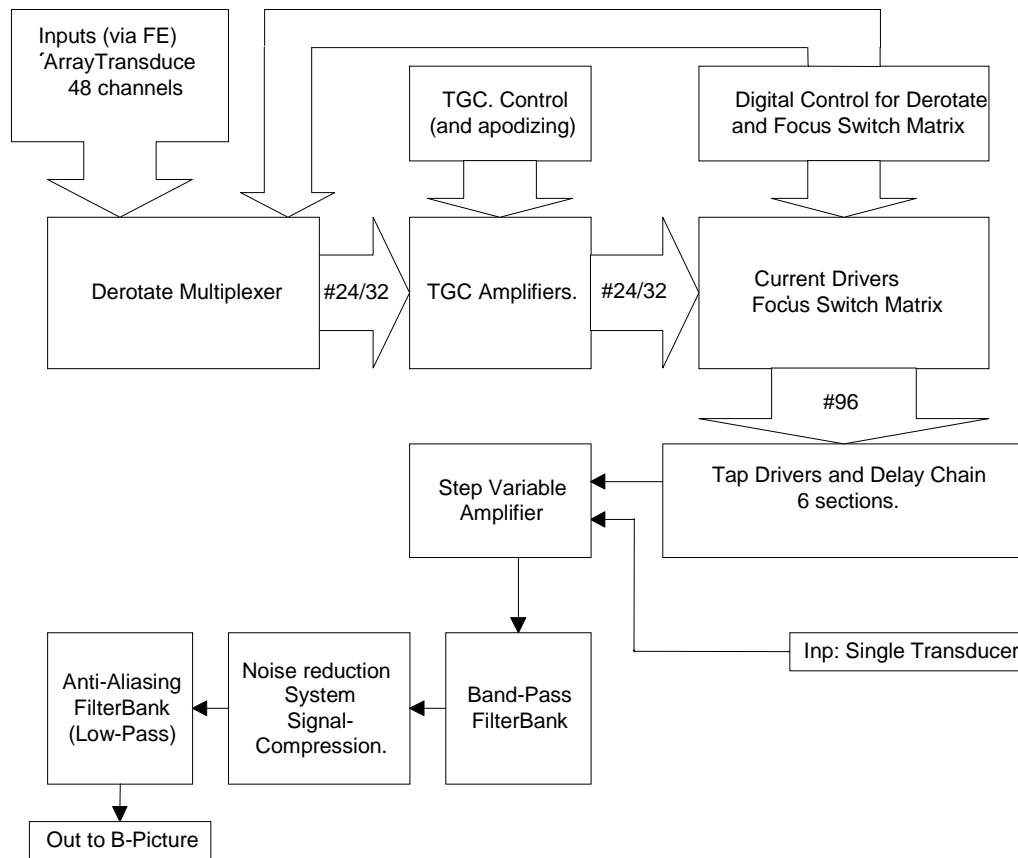

Fig. 8.3-2. Delay board

The signal lines from the Front end board are lead into a bank of switches in a 48/64:24/32 configuration which derotates the 48/64 symmetrical received channels into 24/32 independent channels for TGC and beamforming. The switches consist of nine 8:16 cross-point switches, with configuration data in a local RAM accessible from the Core board CPU.

After the derotation of the signals they are amplified in 24/32 TGC amplifiers including current-to-voltage conversion and circuitry for receive apodizing.

A principle called Incremental Analog Beamformer **IAB** (see detailed description below) is used for beamforming of the received echo signals. The IAB consist of one single chain of delay-lines. This delay chain performs the dynamic receive focus by delaying the signals from the transducer element pairs into a time correlated beam signal. This is obtained by moving the input position of each signal to the delay chain, as the delay requirement is changing as a function of time. The system can be considered as a zone-switching system with 8000 different zones, in which the width (in tissue) of each zone is less than 0.2 mm.

At the same time a step-variable amplifier provides the final setting of the beam-signal amplitude in steps of 0.5 dB (from -11.5 to +20dB) before entering the bandpass-filter. The resolution and gain settings of this amplifier is designed to compensate for level difference between Odd/Even apertures. The step variable amplifier is controlled in parallel with the settings of the delay system in accordance with a set of gain values, which are located in the focus table along with the delay information.

The settings of gain produce switching noise which is added to the beam signal. The sum of the beam signal and all the switching noise is passed through the band-pass filtering and on to the Noise Reduction System.

The Noise Reduction System is a digital system based on the fact that the switching noise is the same for each focus table. Each time a new focus table is to be used, the system requires that an “empty” receive period is performed as switch-noise reference (“empty” means: without any transmission taking place). During this reference receive period, a digital representation of the switch signal is saved in a memory device. During the following receive periods, the beam signal contains the sum of the echo signal and the switch signal. This sum signal is digitized, and the memorized part of the beam signal representing the switch signal (noise) alone, is digitally subtracted from the sum.

The noise reduced digital beam signal is then digitally detected, and the signal is processed. Finally, the signal amplitude is digitally converted into logarithmic form. The mapping from linear to logarithmic form is based on values stored in a writeable memory device.

The digital output of the lin/log conversion is fed to a 10-bit D/A converter and thereby converted back to analog form. From here, the analog signal passes through the low-pass anti-aliasing filters and on to the final 8-bit A/D conversion. The output of this converter is the digital input to the scanconverter (on the Core board). The selection of LP-filter and the rate of the final A/D conversion is set by the RTSC (on the Core board) and is thus independent of the beamformer function.

8.3.3. The Incremental Analog Beamformer

The IAB represents a new concept in Dynamic Receive Focus for scanning with Array transducers. Previous versions of B-K scanners have used two identical delay blocks. One block used for the signal while the other block was programmed for the next zone.

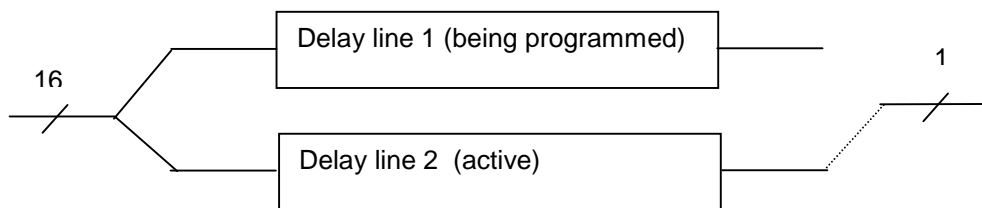

Fig. 8.3-3. “Zone” delay principle

The principle is called the zone method. Each zone represents some receive time, a few micro seconds corresponding to a few millimetres in tissue depth. This concept needs two sets of matching delay and switch circuits with very high and costly requirements to component tolerances.

The Incremental Analog Beamformer uses only one simple chain of delay components and a signal switching matrix for connecting the transducer signal to the delay line. During the programming of the signal connections only one signal line is changed at a time. The method of changing just one signal connection at a time is referred to as an incremental change of delay setting rather than a zone based system with many changes in each programming cycle.

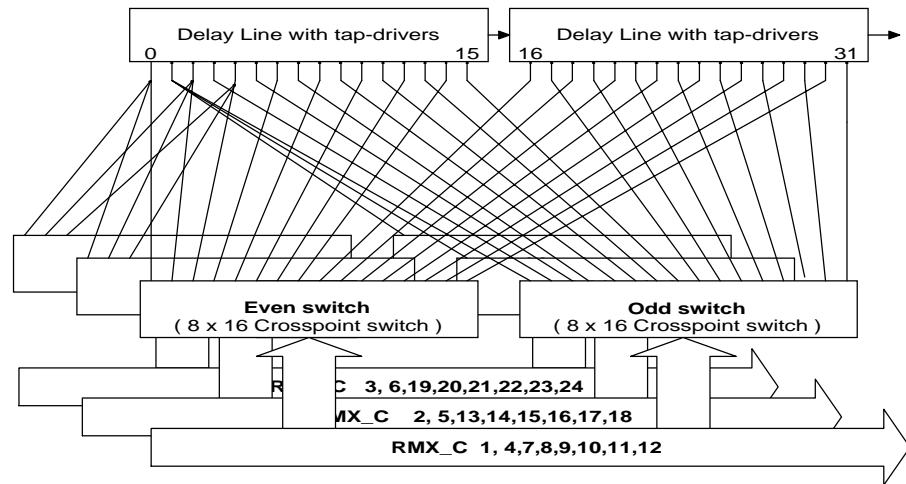

Fig. 8.3-4. The 2101 IAB (simplified)

Fig. 8.3-4 shows an example of 24 signal lines connected to two sections of the delay chain. The signals RMX 1-24 is generated by “folding” the 48 channels used in the 2101 scanner. The crosspoint switches connects the RMX signals to different sections of the delay line, where each bank (even/odd) is switched at 10 Mhz. The fact that the signals are switched at 10 Mhz creates a “zone switching system” with thousand of different zones.

Switching noise is removed by using an “empty” scanline at the beginning of each new sector scan. The switching noise is digitized and stored in a RAM . During the remaining lines of the following sector scan the noise reference values are digitally subtracted from the echo signal.

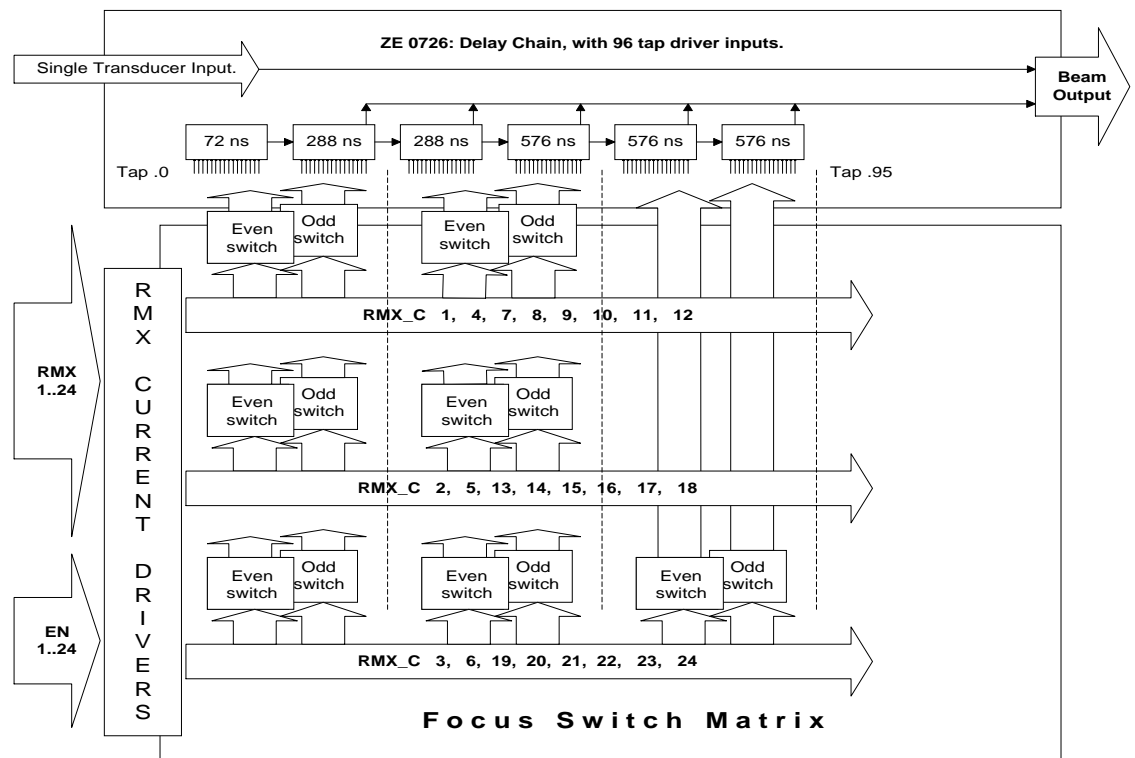

Fig. 8.3-5. The 2101 focus switch matrix

Fig. 8.3-5 shows the 2101 focus switch matrix. The matrix has 24 inputs and connects to 96 input taps of the delay chain.

RMX 1,4,7,8,9,10,11,12	Range tap 0 – 63	(Max 1224 nS)
RMX 2,5,13,14,15,16,17,18	Range tap 0 – 63	(Max 1224 nS)
RMX 3,6,19,20,21,22,23,24	Range tap 0- 95	(Max 2376 nS)

The necessary delay range for the different RMX signals is lowest at the center aperture and highest at the edge of the aperture.

The advantages of the IAB concept:

Only one chain of delay components is needed.

As there are no zones and only one chain, no circuit matching is needed.

The receive focus is close to ideal

8.3.4. Core board

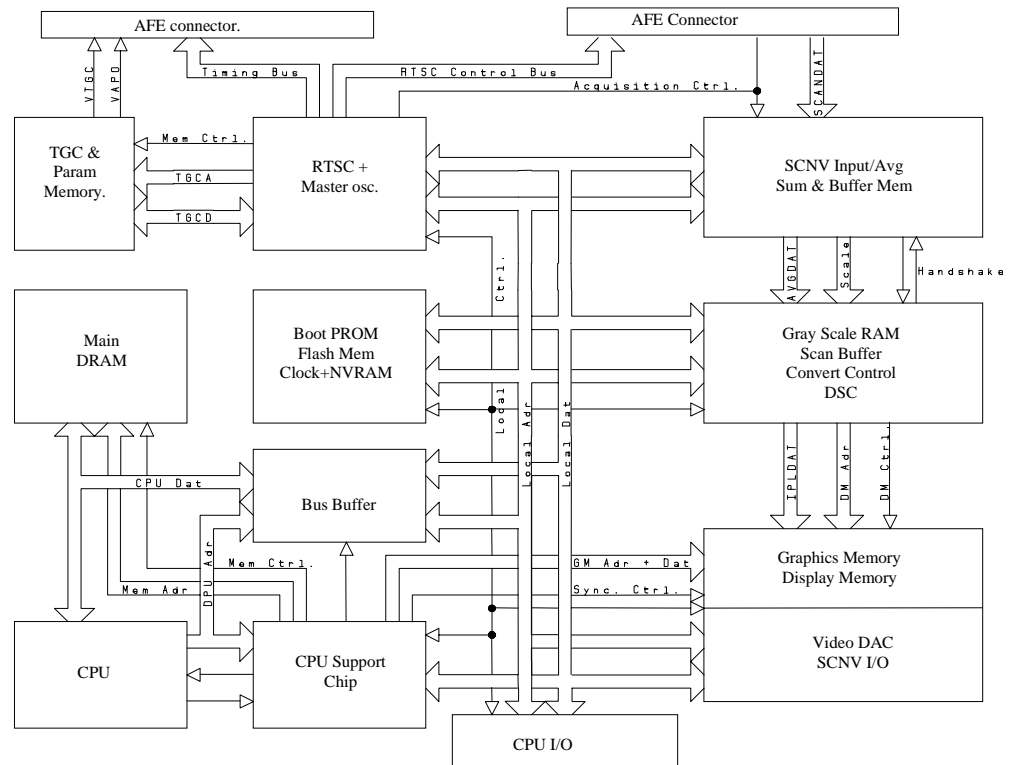

Fig. 8.3-6. Core Board

The Core board consists of three main blocks: CPU system, RTSC, and Scan Converter.

CPU system

This is a 386EX-based CPU system. It has two serial ports used for keyboard (Front panel) and debug terminal. Also embedded in the system is a Floppy disk controller, ECG interface, Foot switch and Light pen connector together with the Configuration switch register. The Graphics system which generates e.g. text and markers on the screen is also a part of this system.

Real-time Scan Controller (RTSC)

Contains the hardware for programming the Front End and Delay board and for generating all reference timing signals for acquisition of image data. It consists of the following modules: 120 MHz master oscillator, Sequencer, TGC/Parameter memory and Buffers/drivers for control busses.

The sequencer and control chip (FPGA) controls transmit and receive timing, data acquisition clocks and TGC/Parameter memory address generation.

The TGC/Parameter memory itself

The SCNV part consists of the following modules:

- A/D converter for converting the beamformed signal to SCANDAT.
- Scan Line Pre-processing system which performs line averaging, assembling of composite focus lines, and Edge Enhancement (Contour).
- Image Averaging System which performs linear averaging of B-images, and handles image review (for all 2D images) and time review for M-mode
- Convert system for interpolation of scan lines to images and control of the display memory.
- Video DAC and rear panel connectors for video/audio.

The purpose of the Scanconverter and Display Subsystem is to convert the 2-D data from the Delay Board to video signals for use in the Monitor.

The data enters the Averaging system where the average of 1 to 14 images are generated. The averaged data is then stored in the Image Review memory image by image.

The scan lines from either the Averaging system (in record mode) or the Review Buffer (in review mode) are fed through a Grey Curve Mapping RAM and into the Scan Buffer.

The Converter Control is the device which generates the distance calculation between data samples in the scanlines and the pixel to be written to the Display Memory.

The converted data is stored in the Display Memory. There are two memory banks as the build-up of a converted image takes place in the background. When the image is converted, the banks are switched. Data from the active bank are clocked out from the VRAMs to a Video D/A converter/Palette circuit. Graphics from the CPU system are entered into the Video D/A converter as overlay to the image data.

8.3.5. Floppy Disk

The Floppy Disk Drive is not exactly a part of the Core, but the controller circuit is placed here. The drive is used for storing and retrieving ultrasound images and for updating the scanner software.

The CFM Post-processor has the following tasks:

1. Receive data from look up tables
2. Discriminate tissue signals
3. Median filtering (to obtain a smooth appearance)
4. Interpolation
5. Output data to the image memory
6. Output data to the scan converter
7. Image memory refresh

All the processing is done by a DSP.

The purpose of the Frame Memory_ to avoid phase jitter caused by B-mode interference. The frame memory allows a continuous recording of the CFM image without B-mode interruption.

8.3.7. Single input module

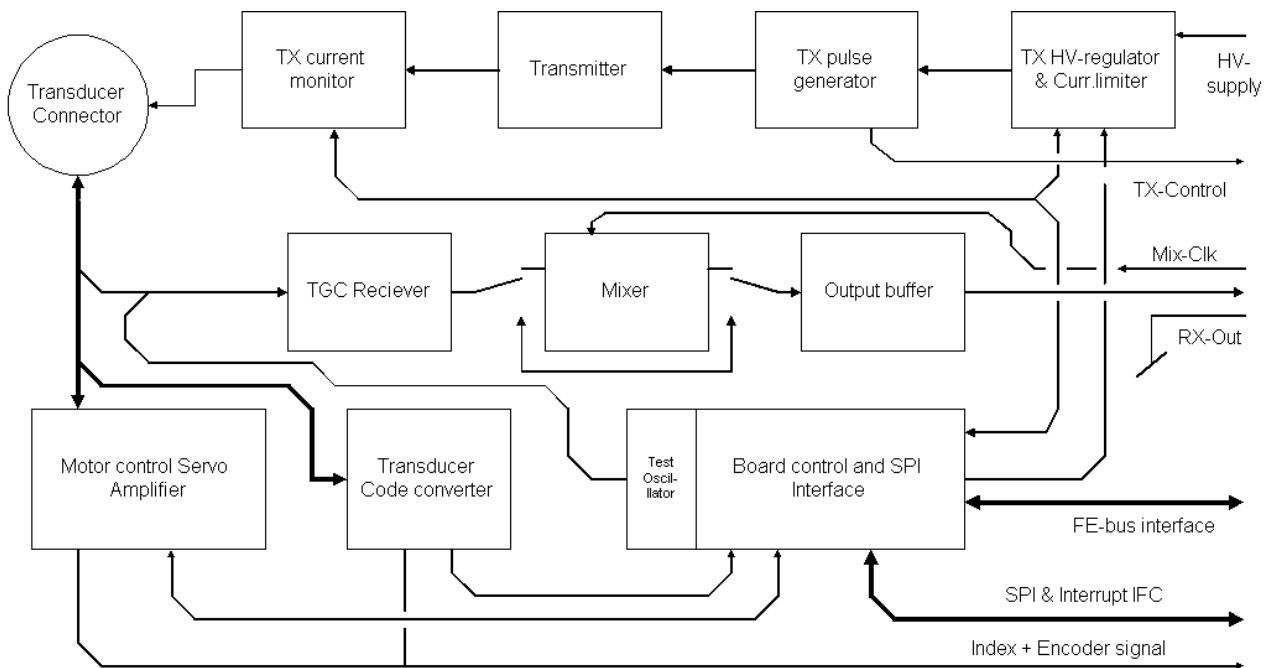

Fig. 8.3-8. Single input module

The Single input module is a self-contained functional block, with separate bus interface and board control, transmitter, receiver and motor control unit included. The transducer code interface circuit, which translate the discrete/analog single transducer codes to a serial data stream similar to the array transducer ID system, is included in the bus interface block.

The transmitter is special designed for the required frequency range.

The receiver front end is a TGC regulated wide-band preamplifier, which provides low input noise and performs all single channel TGC control. For frequencies = 12MHz, the receive signal from the preamplifier is transferred directly to the output stage (and then further processed in the beamformer circuitry). For the transducer frequencies between 15 and 20MHz, the signal passes through a down conversion path (a mixer circuit), which will downconvert the preamplified signals to a frequency inside the frequency range of the A/D converter in the beamformer, in order to prevent signal aliasing problems.

The output from the Single module is fed to the step variable amplifier block on the Delay board.

8.3.8. ECG module

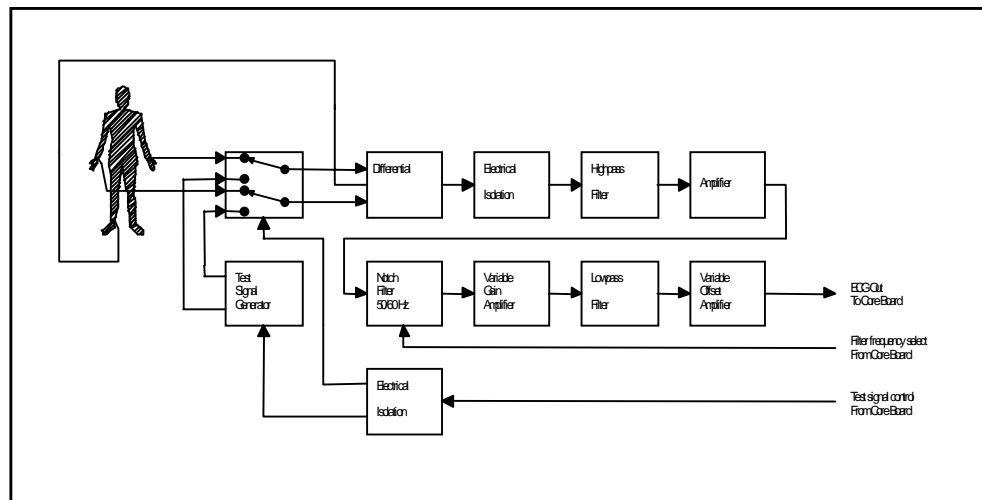

Fig. 8.3-9. ECG module

The ECG Input Module records the electrical potentials generated by the muscles of the heart. Two wires lead the ECG signal from the body to the input stage and one wire leads a reference potential back to the body.

The input stage is a differential amplifier with a very high common mode rejection ratio (CMRR). This highly reduces common mode noise on the input lines. An active potential earth is created and sent back to the patient.

To meet the safety standards the parts connected to the patient must be galvanically isolated from the hazardous parts. This is done by means of isolation transformers and opto couplers.

The High Pass Filter has a low cut off frequency (0.05 Hz) to eliminate the DC component and allow the ECG signal to pass.

A low noise amplifier provides amplification of the small ECG signal before it is passed on to the Notch Filter.

50/60 Hz noise from the mains supply is transferred by capacitive coupling to the patient and hence into the ECG amplifier. This problem is eliminated by the notch filter, which provides high attenuation of signal components at 50 or 60 Hz. The frequency of attenuation is controlled by the Main CPU Board.

The Variable Amplifier determines the amplitude of the ECG signal, and thus the size of the ECG curve on the monitor. The gain adjustment is located on the front panel of the ECG Input Module.

The Low Pass Filter is a high order filter which cuts off high frequent noise above 15 Hz.

The output amplifier provides the final gain of the ECG signal and adjustable offset. The offset potentiometer determines the DC component of the ECG signal and thus the position of the ECG curve on the Monitor. The offset potentiometer is located on the front of the ECG Input Module. From here the signal is passed on to the Main CPU Board.

8.3.9. Power Supply

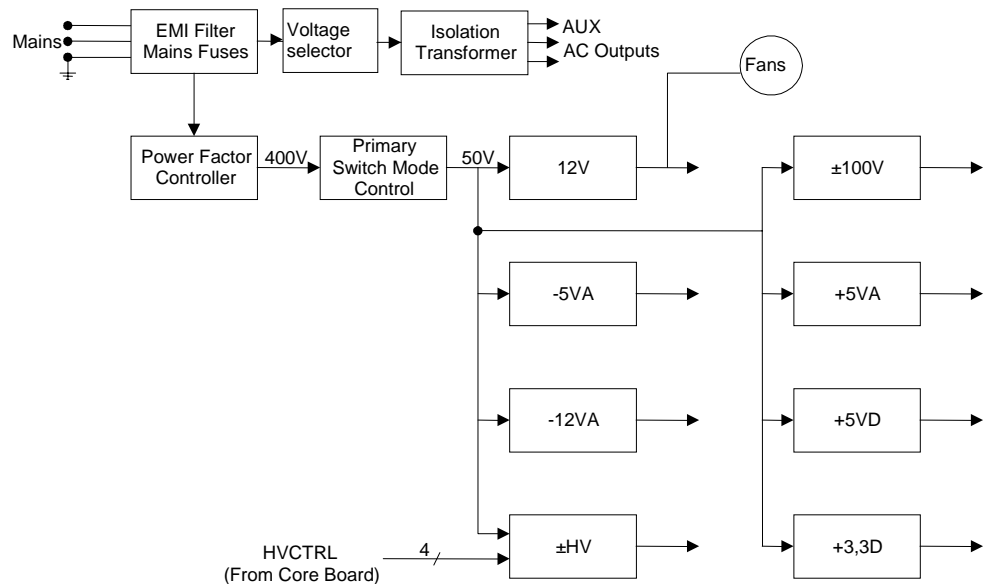

Fig. 8.3-10. Power Supply

The Power Supply exist in two versions – the standard type and a type with “soft power down”. The “soft power down” facility is used in connection with the PC Back-end option here it ensures that the power to the PC Back-end is not removed before the operating system has completed the automatic shut down of the PC. Both types consist of eight switch mode Power Supply Modules. These are: +3.3V, +5 V (for digital circuits), +5V (for analogue circuits), -5V, , +12 V, +12V , ±100V and one programmable HV supply controlled by the Core Board using 4 digital signals. The programmable output is used to drive the crystal elements of the transducers.

The DC outputs are protected against overload by a current limiter.

The Power Supply can deliver a total DC output power of 230 watt and is designed to run on a single mains phase of 90 volt to 264 volt AC. The Power Supply can be set to the actual mains voltage by two switches on the rear side of the Power Supply. A Separation Transformer in the Power Supply provides three auxiliary AC outputs galvanically separated from the mains. The three auxiliary AC outputs have a total maximum capacity of 300 watt with the same AC output voltage as the mains input. The Separation Transformer has a build in thermal fuse that melts if the temperature of the windings exceeds the 120° C.

The Power Supply is internally cooled by three fans.

8.3.10. Monitor

2101: The 12" B/W monitor for the 2101 is a self contained unit, with standard video input signal. It operates at +12 V DC supplied directly by the power supply.

The horizontal scanning frequency can be changed between 15.625 Hz (CCIR) and 15.750 Hz (EIA) without adjustment of the unit. The vertical scanning frequency is 48/64-62 Hz (interlaced).

2102: The 2102 is equipped with a 10" or 12" colour monitor having the same characteristics as the B/W monitor. It operates at mains AC supplied directly by AUX output at the power supply. The monitor is equipped to a 5 pin DIN socket on the scanner. The input is a standard RGB-S output

2102XDI: The 2102XDI is equipped with a 14" non-interlaced colour monitor. The conversion of the video signal from the scanner (interlaced) to non-interlaced takes place in the monitor. It operates at mains AC supplied directly by AUX output at the power supply. The monitor is equipped to a 5 pin DIN socket on the scanner. The input is a standard RGB-S output

2101/02EXL:

The EXL systems are equipped with a 15" non-interlaced colour monitor (VGA). The video board in the EXL machines generates a standard VGA signal to the monitor. It operates at mains AC supplied directly by AUX output at the power supply. The monitor is equipped to a 15 pin SUB-D socket on the scanner.

The monitors has external brightness and contrast controls. Furthermore the monitor is mounted with a tilt mechanism.

8.4. PC Backend

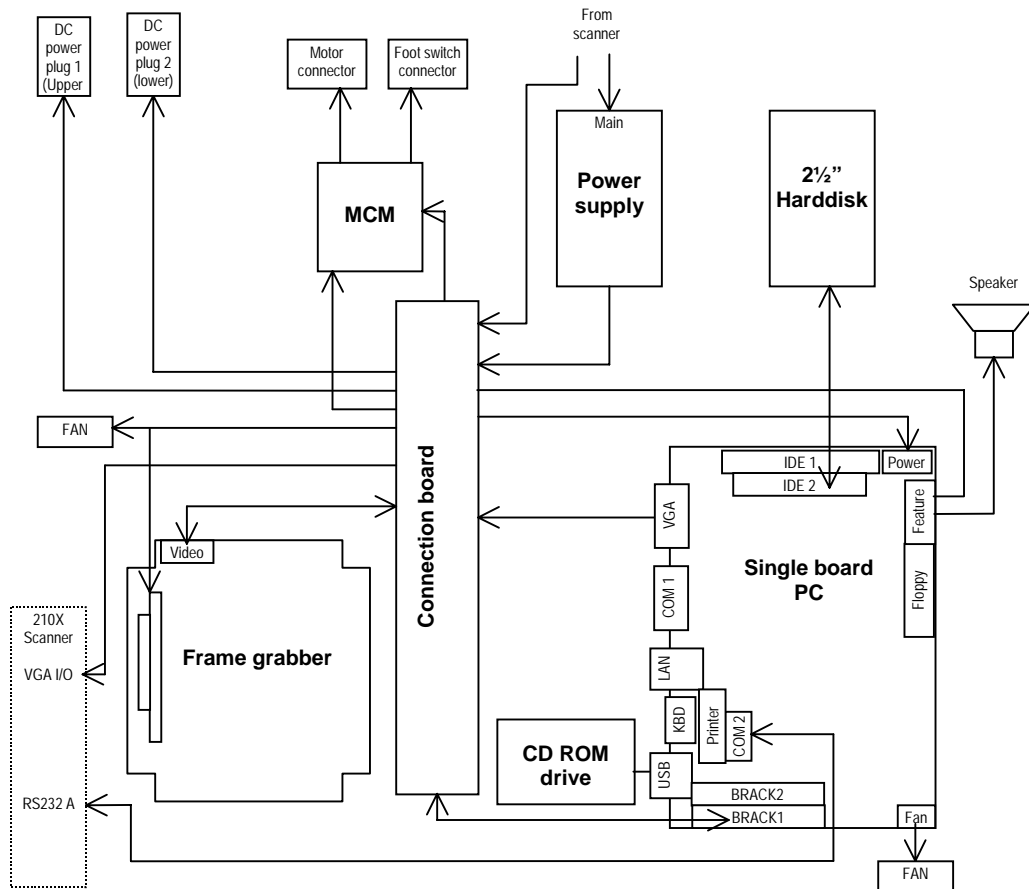

Fig. 8.3-11. PC Back-end

The PC Back-end is based on a single board PC. The PC is equipped with a harddisk which holds the operating system (Windows 2000), the application software and is also used for storing the scan volumes. A CD ROM drive is used for archiving and importing scan volumes. A frame grabber grabs the image directly from the video board in the cassette of the scanner. The video out from the PC is via the Connection board routed to the input of the video board of the scanner.

The PC Back-end is powered from a local Power Supply. The local Power Supply is fed with voltage from the Power Supply in the scanner. A "soft power down" facility ensures that the power from the scanner Power Supply is not removed before the PC has been shut down. When the user turns off the scanner Power Supply a signal is given to the Single board PC which then automatically starts the shutdown procedure. when completed a signal is given to the scanner Power Supply which then turns of the power completely. If the PC is not responding a time out function will force the power supply to turn off.

The MCM module (Mover Control Module) enables the use motorised movers. This ensures the movements of the transducer is controlled. Three types of movers are supported: ECRM (EndoCavity Rotational Mover), Pull back mover and the integrated mover in the type 2050 transducer. The MCM module also holds the foot switch connector.

8.5. 2101/2 Test facilities

The 2101/2 tests are all visual tests creating an image on the monitor (refer to sec. 4 for details)

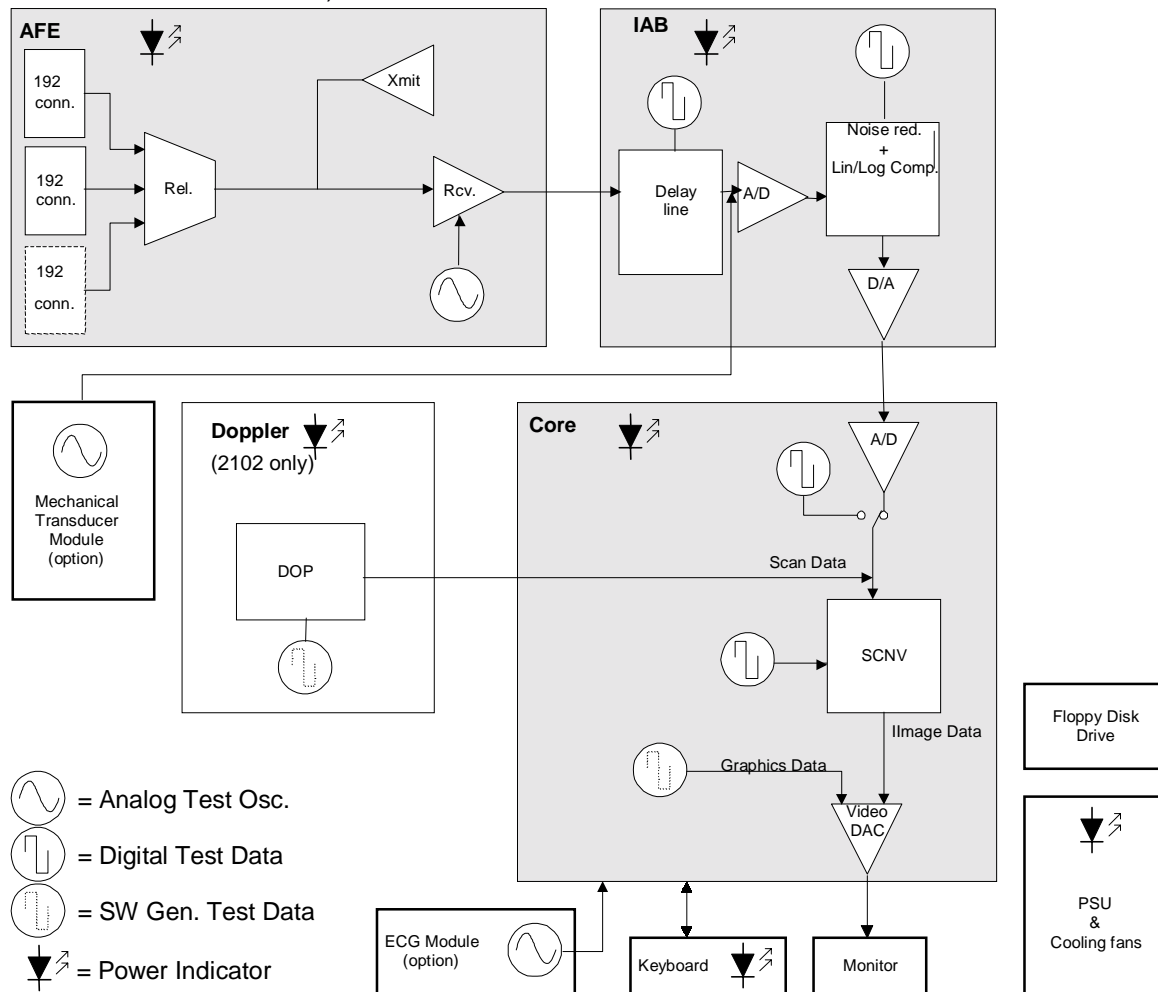

Fig. 8.3-12. Test Facilities in Ultrasound Scanner 2101/2102/2102XDI

The Analog Front End oscillator operates at 5.003 MHz and connected to all 48/64 signal lines via small capacitors. The 3KHz offset is used when testing the Doppler board. The test is a verification of the receiver, delay and the scanconverter.

The Delay board has three test possibilities for generating test pictures on the monitor. Delay test 1 is a verification of the digital noise reduction system. The test signal is generated in a FPGA on the delay board.

Delay test 2 is a verification that all 48/64 channels from the front end board to the delay board are active. The test is using the test oscillator on the front end board.

Delay test 3 is a verification that all 24/32 inputs on the beamformer are working. The test is using the test oscillator on the front end board.

The Core board has a digital test oscillator for generating test pictures and a software "test oscillator" for setting up monitor test pictures.

This page is left blank intentionally

Section 9

SYSTEM INTERCONNECTIONS

CONTENTS	PAGE
9.1. Introduction	9-2
9.2. PCB Locations	9-2
9.3. Cable Connections.....	9-2
9.3.1. Identification Table.....	9-2
9.3.2. System Interconnection Diagrams.....	9-3
9.4. Dip Switch Setting.....	9-6
9.5. Multi-pin Connections	9-7

9.1. Introduction

By showing the PC Board locations and external cable connections, i.e. cables between PCB's, this section aims to help you keep track of important signals in the 2101 and 2102. Further is described switch/jumper settings for quick reference.

9.2. PCB Locations

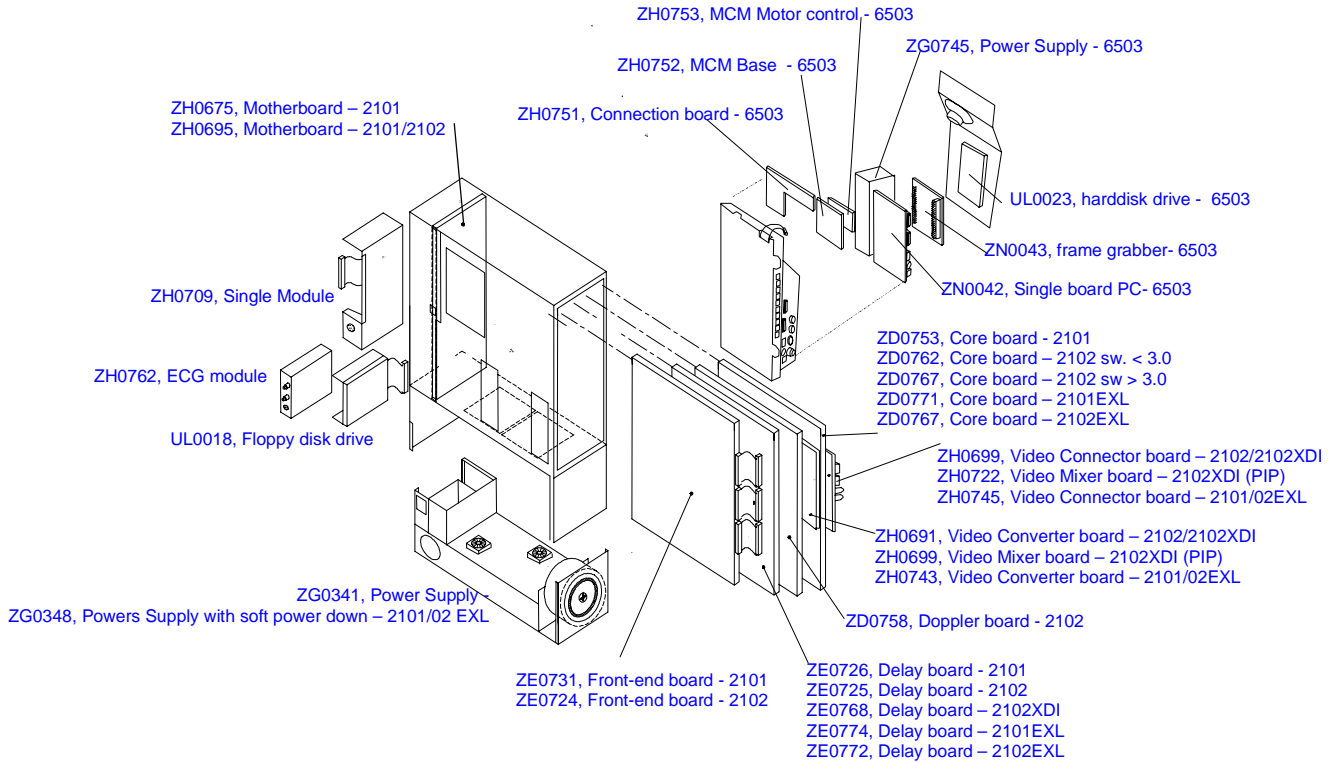

Fig 9.2-1 PCB Location

9.3. Cable Connections

The 2101/2102 Interconnection diagram, figure 9.3-1 to 9.3-3, shows the cable connections between parts in the Falcon and the Hawk. To simplify the diagram all the cables are shown as single lines regardless of type and number of leads. The PC Back-end option is shown in a separate diagram.

9.3.1. Identification Table

Cable no.	Type	No. of leads	Connecting
AQ1669	Ribbon	34p	Analog Front End - Delay Board
AQ1672	Ribbon	2 × 34p	Analog Front End – Delay Board
AQ1670	Ribbon	10p	ECG - Mother Board
AQ1665	Ribbon	6p	Gain Board - Potentiometer Board
AO2016	Single	6p	Trackball - Potentiometer Board
AQ0590	Flexible	-	Floppy - Mother Board
AO0415	Single	8p	Keyboard - Mother Board
AQ1668	Ribbon	50p	Single Module - Mother Board

9.3.2. System Interconnection Diagrams

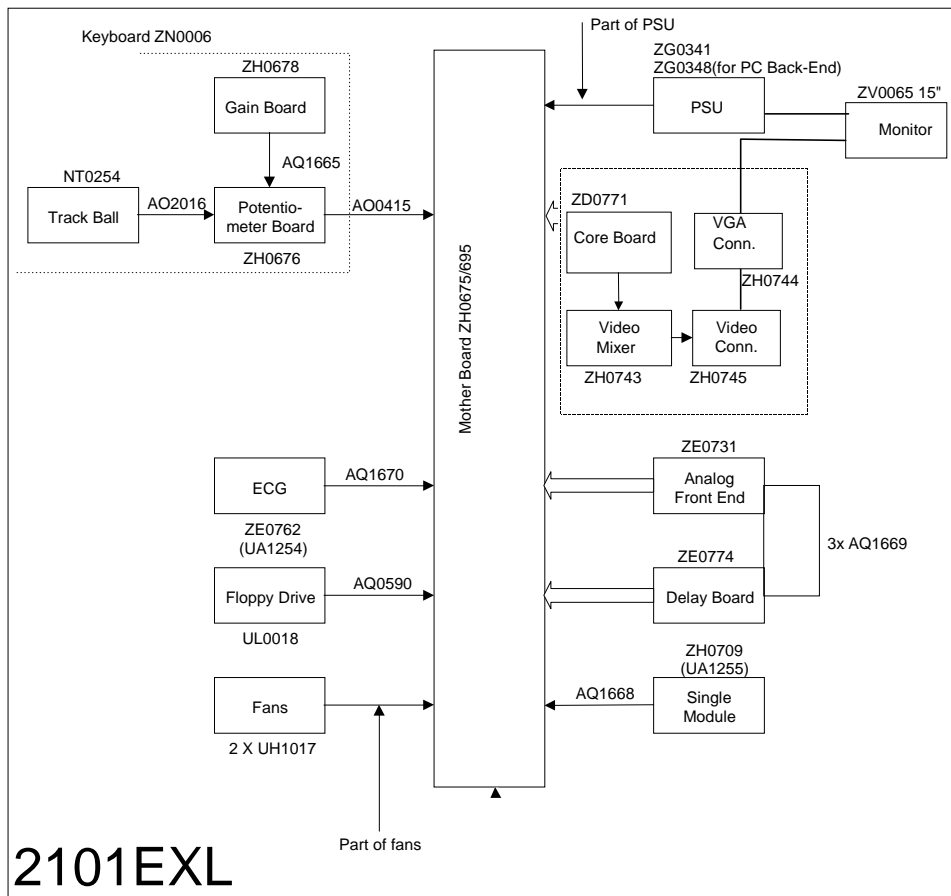
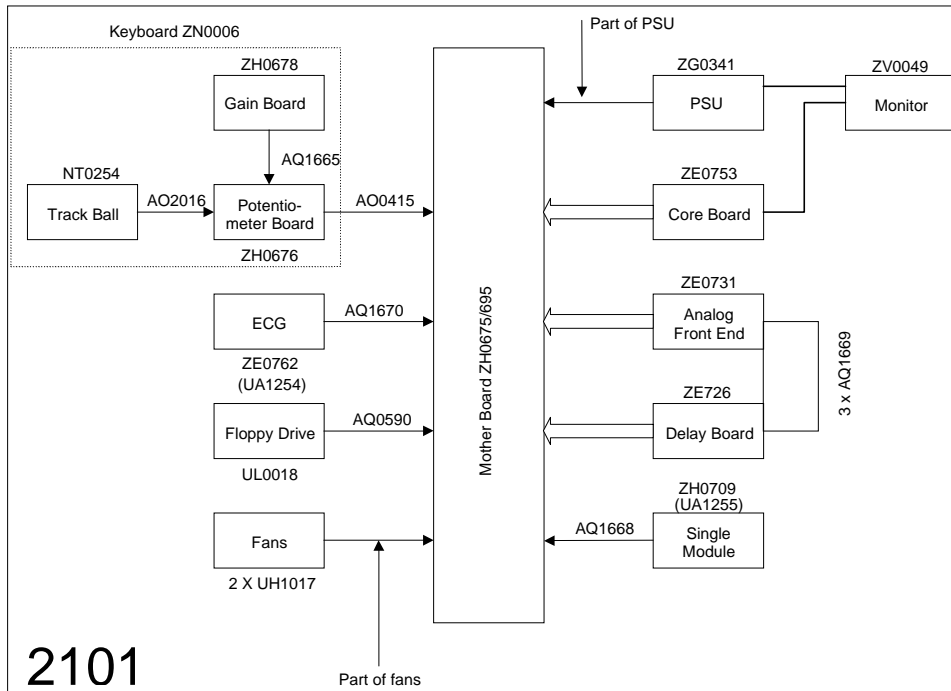

Fig. 9.3-1 2101 System Interconnection Diagrams

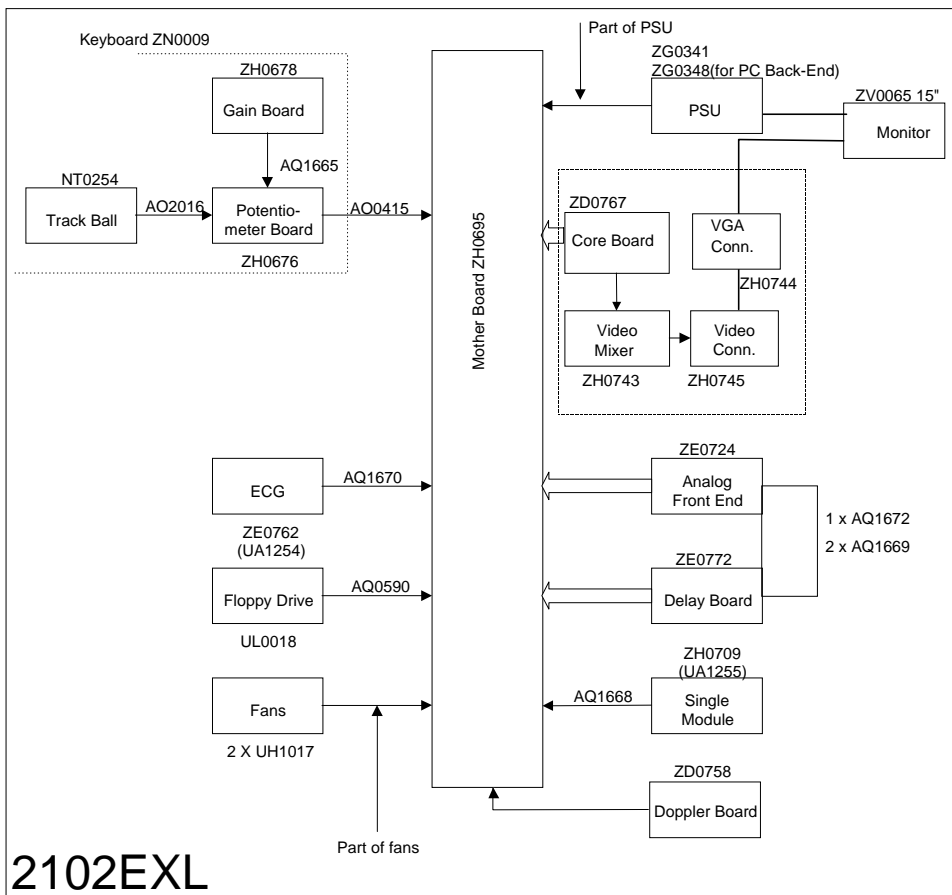
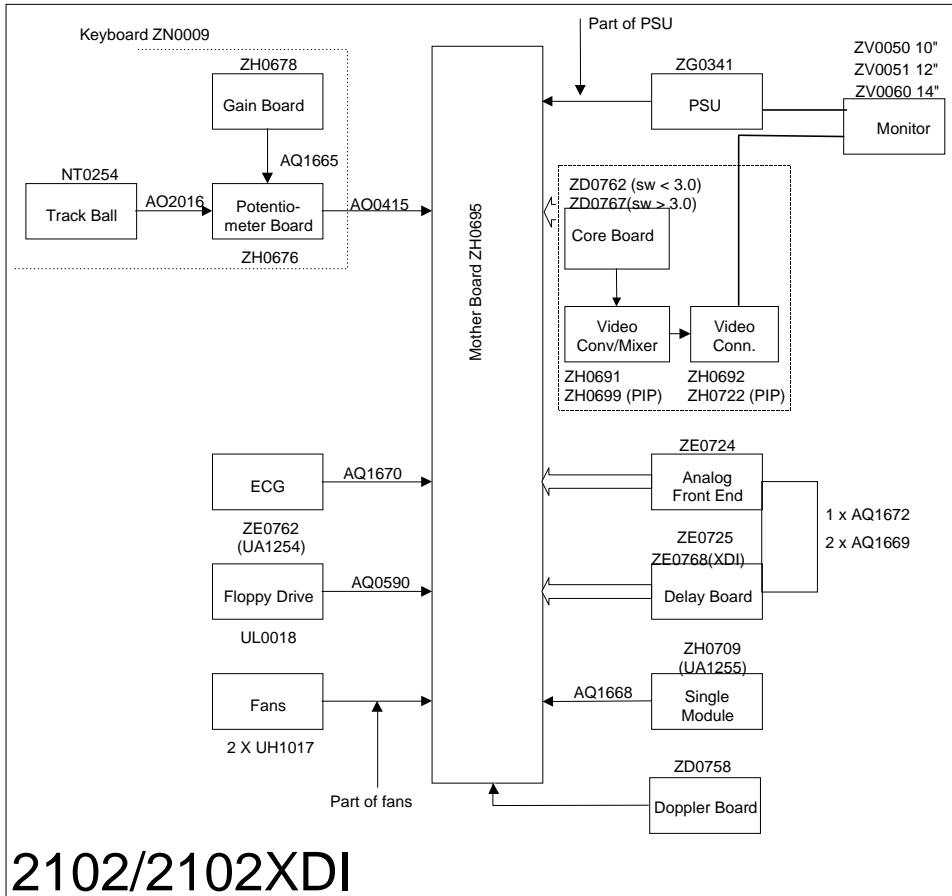

Fig. 9.3-2 2102 System Interconnection Diagrams

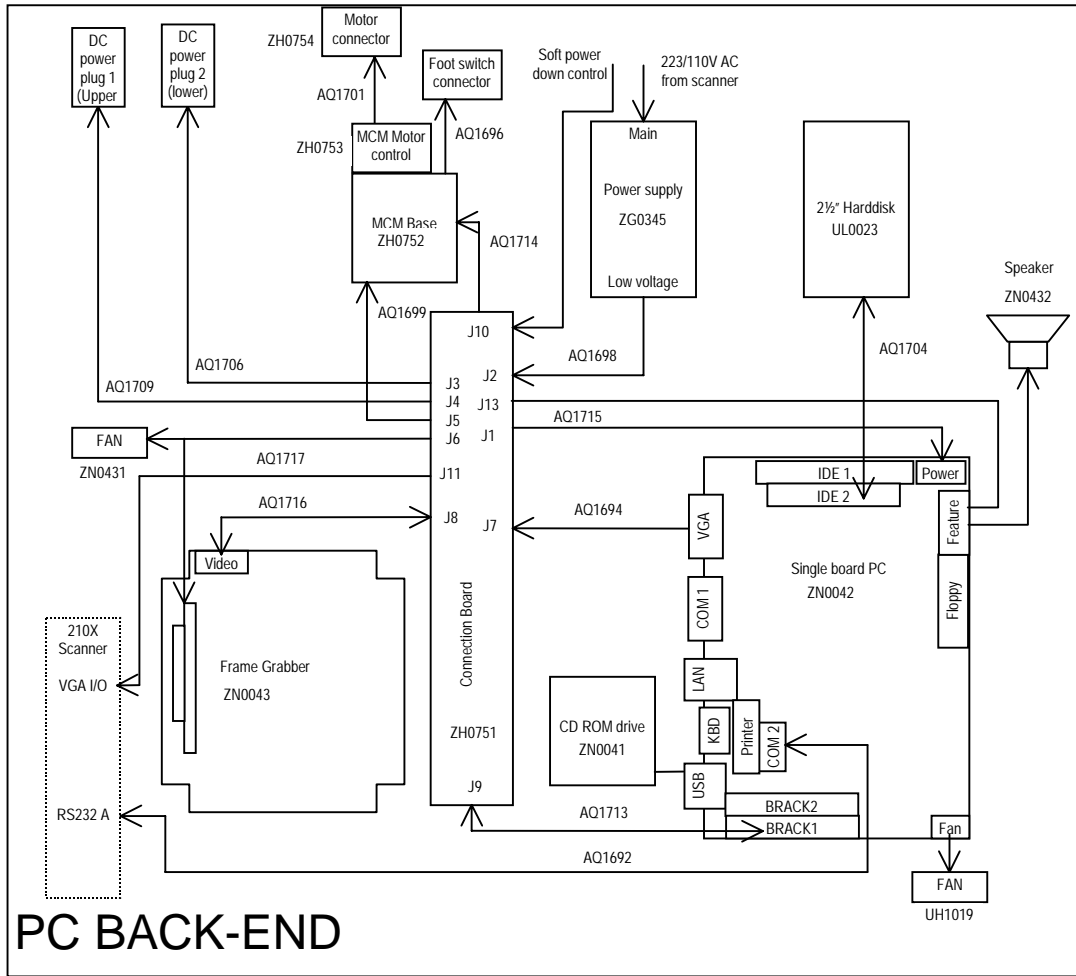

Fig. 9.3-3 PC Back-end System Interconnection Diagram

9.4. Dip Switch Setting

Dip switch S1 on the Core board.
 Accessible from the rear of the 2101/2102.

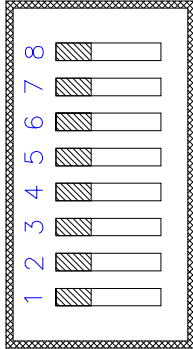

Fig. 9.4-1: DIP Switch

Default: Left

SW8 Right Left	Debug Terminal Debug enabled Debug disabled
SW7 Right Left	NOT USED
SW6 Right Left	NOT USED
SW5 Right Left	Debug Debug B Debug A
SW4 Right Left	ECG Filter 60Hz 50Hz
SW3 Right Left	TV Standard NTSC PAL
SW2 Right Left	RS232 mode Enhanced (3D or BKCOM option) Standard
SW1 Right Left	Language English User definable

9.5. Multi-pin Connections

The following section describes the multi-pin connectors situated on the rear of the 2101/2102.

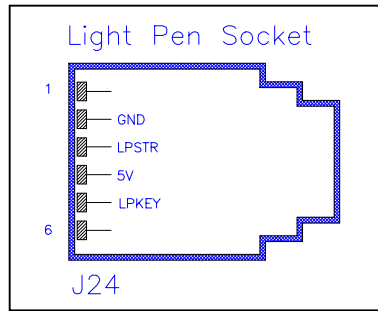

Fig. 9.5-1 Light Pen Socket

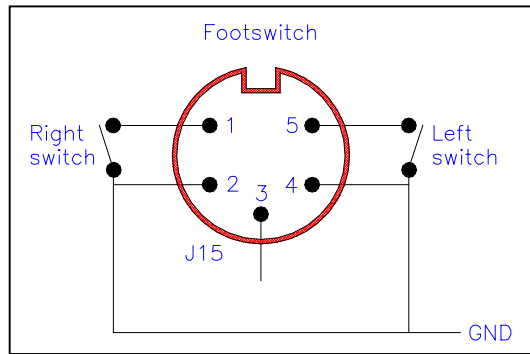

Fig. 9.5-2 Footswitch (scanner and optional PC Back-end)

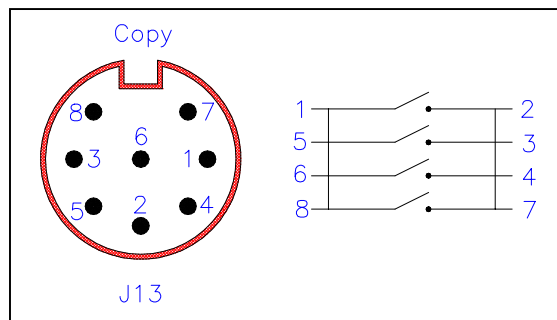

Fig. 9.5-3 Copy (Doc. trigger)

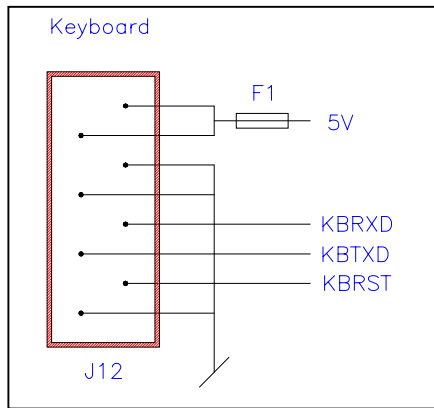

Fig. 9.5-4 Keyboard

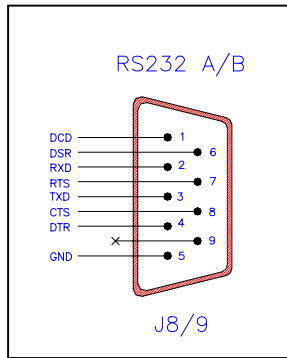

Fig. 9.5-5 Interface: RS232 A/B.

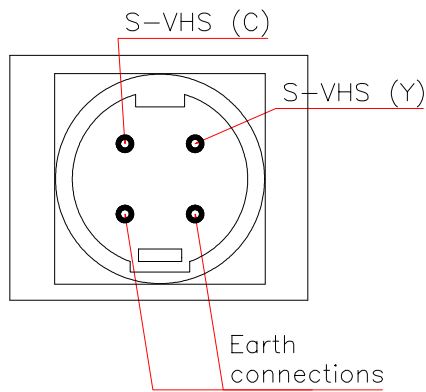

Fig. 9.5-6 S-VHS Socket (2102)

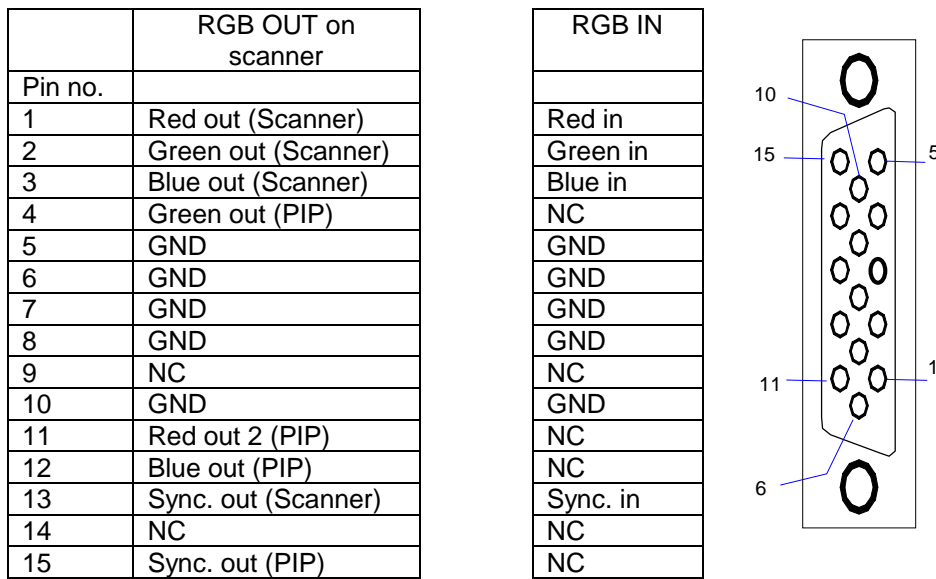

Fig. 9.5-7 RGBS socket (2102/2102XDI)

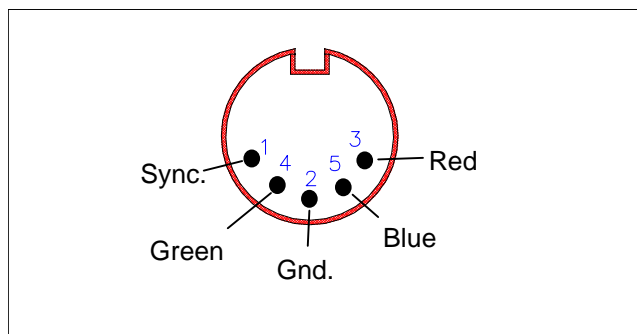

Fig. 9.5-8 Internal monitor socket (2102/2102XDI)

Pin no.	VGA OUT on scanner
1	Red out
2	Green out
3	Blue out
4	NC
5	GND
6	GND
7	GND
8	GND
9	NC
10	GND
11	NC
12	NC
13	Sync. out
14	NC
15	NC

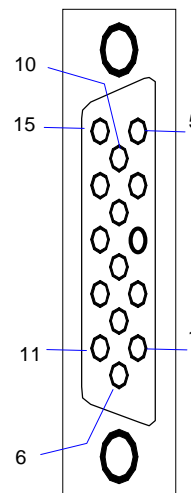

Fig. 9.5-9 Internal monitor socket (210102EXL)

This page is left blank intentionally