



Carpe Iter Pad v4 Manual

v2.7

November 7, 2022

Applicable models: **v4, v4b** ("Device" or "CI Pad")

Table of contents

1. General description.....	1
2. Accessories.....	1
3. Before first use.....	2
4. Controlling elements, ports.....	2
5. Use – Android general tips.....	4
6. Use – Carpe Iter specifics.....	5
7. Charging/Battery Indicator.....	6
8. Operating conditions / instructions.....	8
9. Carpe Iter Holder ("Holder").....	9
10. Power source.....	14
11. Troubleshooting.....	17
12. Disclaimer.....	20
13. Manufacturer's Warranty.....	21

1. General description

- 1.1. The Device is Android powered smart device, which is able to run most applications designed for the respective Android generation;
- 1.2. Please refer to technical specifications of your model for more detailed description of the Device's features and abilities.

2. Accessories

- 2.1. Standard accessories for CI Pad:
 - 2.1.1. cloth pouch with shoulder strap;
 - 2.1.2. USB-A to USB-C adapter;
 - 2.1.3. SIM card adapter;
 - 2.1.4. wall USB charger (EU socket);

ULW Czech, s.r.o.

V Ráji 34, Praha 9 - Hostavice, 198 00, CZ, IČO: 28256212, DIČ: CZ28256212



- 2.1.5. M8 charging cable with dust cap for M8 charging connector. The M8 charging cable mates with our proprietary 12V power source for use on vehicles with 12VDC electrical system. One power source is included with our Carpe Iter Holder and can also be purchased separately.
- 2.1.6. Dust cap for M8 charging connector.
- 2.2. Carpe Iter Holder (“**Holder**”) for motor vehicles, especially motorcycles. The Holder is sold in two versions – charging (includes a proprietary power source for the Device and pogo pin charging connector) and non-charging. In case you decide to use non-charging version of the Holder, CI Pad can be charged via the M8 charging cable from our proprietary power source (power source is included with a special CI Pad set for non-charging Holder or can be purchased separately). When this manual refers to charging via the Holder, it refers to the charging version of the Holder.
- 2.3. Brackets to retain the M8 charging cable (M8 charging cable is supplied with the CI Pad and also sold separately) are included with every Holder. Please see addendum to this manual for installation instructions.
- 2.4. Pogo pin charging version of the Holder might require installation of that connector by the user. Please see addendum to this manual for installation instructions.

3. Before first use

- 3.1. Before first use, charge the Device to at least 50% battery capacity with the provided USB wall charger;
- 3.2. Connect the Device to internet;
- 3.3. Open pre-installed Carpe Manger app and install / update at least the following:
 - 3.3.1. “Manager app”;
 - 3.3.2. ”Controller app”;
 - 3.3.3. “GPSTune app” (if available for your model);

4. Controlling elements, ports

- 4.1. The Device contains capacitive multi-touch enabled screen and hardware controlling elements (buttons).
- 4.2. Hardware elements description/use limitations:

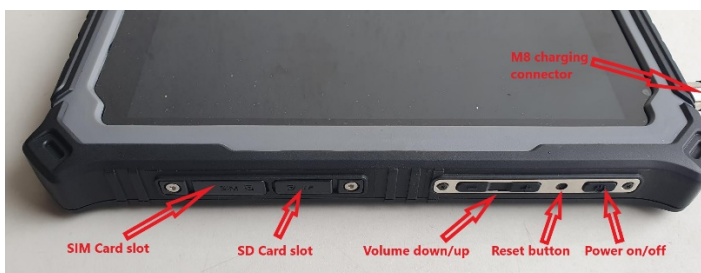

CARPE ITER



- 4.3. USB-C port has OTG (on-the-go) functionality and can be used to charge the Device with the provided USB wall charger and to transfer data from or to the Device from a compatible computer. **Do NOT use third party quick chargers.**
- 4.4. Access to USB port, SIM and SD card slot and audio jack is protected by flaps. Those flaps must be properly closed to achieve water and dust resistance. Closing the flaps incorrectly will damage them when inserting the Device into the Carpe Iter Holder (“**Holder**”). Do not use sharp object to open the flaps – it will damage the seal embedded into the flap and compromise water resistance and allow dust and debris to enter the Device, which will result in damage to the Device. Such damage is not covered by our defect warranty.
- 4.5. For proper flap closure refer to graphics:

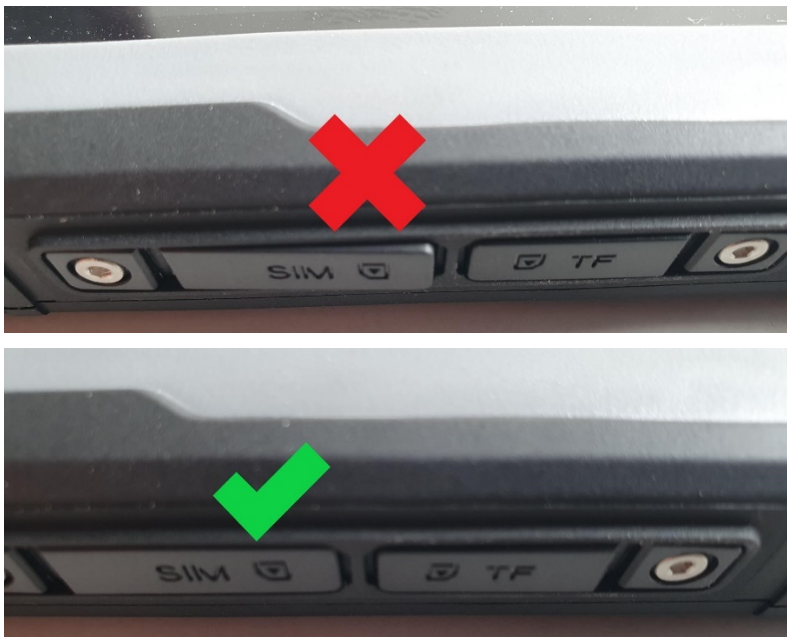



- 4.6. When closed properly, the port flaps will be completely flush with the Device's body. It might take some force to push them into correct position.
- 4.7. Do not use sharp objects to open the port flaps or you will damage the seal and compromise water resistance.
- 4.8. Correct SIM and SD card orientation:



- 4.9. The SIM and SD card must lock into position – push deeply into the Device until you hear a click. Do not use a sharp object or you might damage your SIM/SD card or the port.
- 4.10. When the M8 charging cable is not used, always screw back the M8 charging connector cap firmly or water resistance of the Device can be compromised. Closing caps are available as spare parts.

5. Use – Android general tips

- 5.1. The Device is powered by Android operating system. In case you use Android powered smartphone, the environment should be familiar to you.
- 5.2. For general Android guide refer here:
<https://support.google.com/android/?hl=en#topic=7313011>
- 5.3. Google Play:

CARPE ITER

- 5.3.1. Recommendation: use GPS and let the Device achieve 3D position lock before you sign into your Google account (that will let Google choose the correct version of their apps based on your location);
- 5.3.2. the Device has been pre-certified with Google. To use Google Services (and Play Store), simply log into your Google account;
- 5.3.3. you might need to let the Google apps to update, before you will get full use of Google Play Store app. To check for updates, open Play Store app and before you sign-in, open the Overflow Menu (three dots top right corner) and select “Check for updates”:



- 5.3.4. you can use the same Google account on the Device, which you use on your Android smartphone. That will let you enjoy apps you might have already purchased also on the Device (subject to operating system compatibility and subject to other limitations Google might chose to impose on your purchases).
- 5.3.5. It might take a while, before your previous purchases appear as available for download. In exceptional cases, you might need to clear the cache for both Google Services and Google Play Store apps, perform manual Google apps update and sign into your Google account again (refer to Google Certification manual on our Support web page).

6. Use – Carpe Iter specifics

- 6.1. CI Pad v4 automatically starts when it is connected to power (USB wall charger, Holder/M8 charging cable). This feature cannot be turned off.
- 6.2. The Device comes with pre-installed Carpe Manager app (“Manager app”):

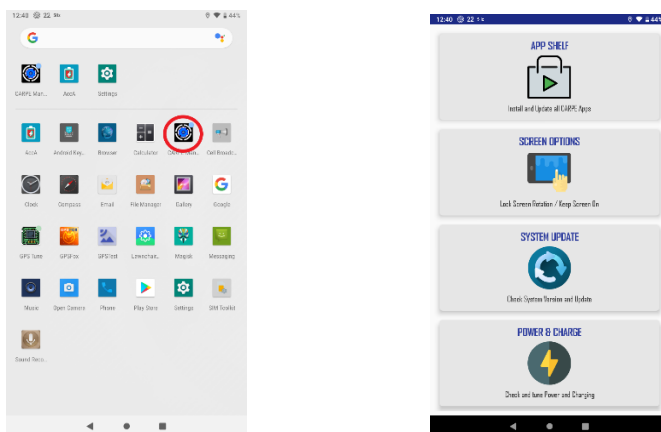

ULW Czech, s.r.o.

V Ráji 34, Praha 9 - Hostavice, 198 00, CZ, IČO: 28256212, DIČ: CZ28256212



- 6.3. The Manager app provides additional functionality and is used to download software specific for the Device and its updates. Please refer to our web pages for details.
- 6.4. It is essential to regularly check the Manager app for updates and new downloads available for the Device. These updates might not only enhance functionality, but also remedy known issues.
- 6.5. The GPSTune app must be installed and running to be able to use GNSS location services.

7. Charging/Battery Indicator

- 7.1. The Device can be charged via its USB-C port, charging pads on the back of the Device and M8 connector.
- 7.2. The Device will automatically start, when power is detected on charging input. **The feature is conditional to sufficient battery level** (the device will not start automatically, if the battery is depleted at the time power was detected on charging inputs).
- 7.3. Use the provided USB wall charger to charge the Device through the USB port. **NEVER use other brands quick USB chargers (especially quick chargers can damage the USB and charging circuitry).**
- 7.4. For charging the Device on a (motor)vehicle, you must use our Carpe Iter Holder ("Holder") - charging version, or M8 charging **cable with our proprietary power source**. Using any other power source will void your warranty. Do NOT replace the connectors between the Holder / M8 charging cable and the power source nor otherwise interfere with the wiring. Re-wiring the connection between the Holder / M8 charging cable and the power source will void your warranty.
- 7.5. One power source is included with the charging version of Holder and it will accommodate simultaneous charging through the Holder and also through the M8 charging cable or charging through the Holder or the M8 charging cable (you can use both or just one of those ways). To charge the device through the M8 charging cable without the Holder, the Carpe Iter power source can be purchased separately.
- 7.6. NEVER charge the Device via USB and M8 charging connector simultaneously. NEVER charge the Device via USB and Holder simultaneously.
- 7.7. USB-C port must not be used, when the Device is employed on a vehicle, especially not on a motorcycle (except when stationary with engine off). The shocks and vibrations the Device will receive when riding will damage the USB port.
- 7.8. M8 charging connector **must NOT be connected to a second power source**, when charging the Device from both the Holder and M8 charging cable or the Device will be damaged (simultaneous charging through both the Holder and the M8 charging cable is only possible from one and the same power source).
- 7.9. The Device charging capacity is limited to approximately 2A. If too many services are running on the Device, the current consumption might exceed the charging capacity, which will result in gradual battery level decrease, even when charging. Almost 70% of charging capacity is drawn by the LCD when set to full brightness. In case of increased requirements on energy consumption reduce LCD brightness.

CARPE ITER

- 7.10. The Device's charging capacity is more than sufficient for casual use (LCD to full brightness, GPS on, one actively running navigation application with track recording).
- 7.11. CARPE Manager app will automatically cycle the battery between 60-80% when charging via USB wall charger, Holder and M8 charging cable. It will take in consideration your battery level, temperature, calibration accuracy, system load input current and screen brightness to adjust the charging in more than 40 possible combinations. Under certain conditions charging to 100% will be automatically allowed by the charging algorithms, such as in case the battery level indicator needs calibration (see Section 7.14).

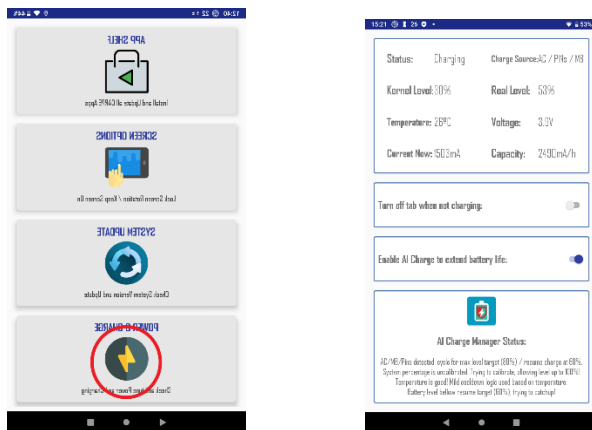

- 7.12. The power management can be turned off by disabling AI charging algorithms, which will allow charging to 100% capacity (it is not recommended to keep the Pad charged to 100%, since it can cause premature battery failure and overheating):

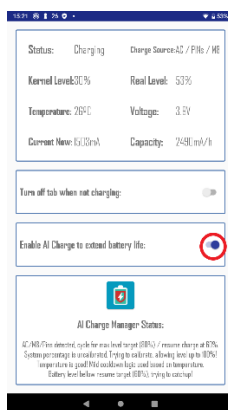

- 7.13. System battery level indicator (battery level shown on main screen) is for orientation only. It may be necessary to calibrate the battery level indicator from time to time to achieve accurate readings (refer to Troubleshooting section). Regardless of the values shown by the System battery level indicator, the real battery voltage is the only relevant criteria for the Device's operation (even when the System battery indicator is showing 1%, the Device will not shut down until the battery voltage goes down to 3,5V).
- 7.14. The Carpe Manager app will attempt to calibrate the system battery level indicator at times the deviation from real capacity will exceed acceptable parameters. The calibration process may take a few minutes. During the calibration, the battery level indicator can show various values, but they will settle after completing the calibration procedure.

- 7.15. Real battery level can be verified in the Manager app - Power&Charge (refer to Section 7.11) or on the System pull down menu:

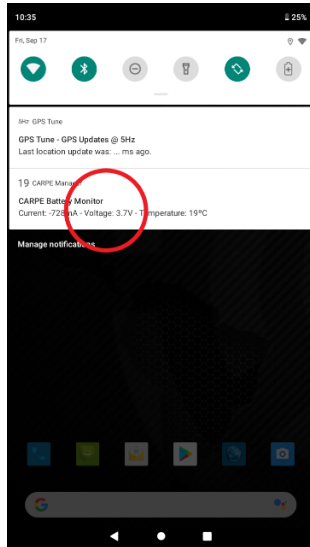

- 7.16. System battery level will not be equal to voltage level most of the time. This is normal (System battery indicator is not linear to voltage level).
- 7.17. Voltage of fully charged battery after disconnecting from charger will be around 4,2V. Voltage of fully depleted battery is 3,5V. When the voltage level of the battery meets 3,5V or drops below, the Device will automatically shut down to prevent damage to the battery.

8. Operating conditions / instructions

- 8.1. The Device is not designed to be placed on your vehicle permanently. When not in use, remove the Device from your vehicle and store it in a safe place with temperature between 0 – 35°C.
- 8.2. The Device should not be operated outside ambient temperature range between 0-40°C or the battery contained in the Device or it's electronics can be damaged. The Device has temperature protection system, which might cause the Device not to start or shut down automatically, when the operating temperature range is exceeded. This automated protection system is only a fail-safe and does not relieve you of the need to ensure yourself correct operating conditions.
- 8.3. Considerable heat is generated by the Device's LCD and when charging. When high ambient temperatures are present, overheating might be prevented by reducing LCD brightness and/or disabling charging. While charging in the Holder or through the M8 charging cable, the Device will attempt to cycle between 60 and 80% battery capacity, which not only preserves the battery, but also reduces the chances of overheating (the charging algorithms might attempt to reach 100% battery capacity in a particular case, if full battery charge is required to calibrate battery level indicator and/or the temperature and other conditions allow that);
- 8.4. If you need to use the Device in sub-zero temperatures, make sure the Device is not thoroughly cooled below 0°C before you start it (do not leave it on the bike). During use, heat is generated inside the Device, so use in sub-zero temperatures is possible. Never use



the Device below minus 5°C (the heat generated by the Device's operation might not be sufficient to ensure minimum operating temperature).

- 8.5. Protect the Device from heat sources that could cause the temperature inside the Device exceed the operating parameters mentioned above.
- 8.6. When your vehicle is stationary, protect the Device from direct sunshine, which can cause the internal Device's temperature to rise well above the ambient temperature (remove it from the Holder or cover it).
- 8.7. Long term exposure to sunshine can cause LCD fading (such fading is not considered a defect).
- 8.8. While riding in wet conditions (e.g.rain), protect the Device from direct airstream (position it behind a wind shield / mask). At high speeds the rain will create pressure equal to jet water, which exceeds the Device's protection rating.
- 8.9. Before you charge your vehicle's battery, always remove the Device from the Holder and disconnect the M8 charging cable from the Device. If the Holder power source is connected directly to the vehicle's battery or "always on" auxiliary power outlet, the charger will trigger the power source in the Holder, which could lead to problems with charging and possibly harm the Device due to frequent power on/off condition created by pulses generated by the charger.
- 8.10. When the Device is not in use, power it off to prevent complete battery depletion. The Device will power down automatically when the battery is close to depletion. Nevertheless, the Device still consumes small amount of energy even when in OFF state, which could lead to deep battery discharge, if the Device was powered down at low battery level or even powered down automatically because of depleted battery. Battery will be damaged or destroyed by deep discharge. To prevent battery damage, ensure that a depleted battery is re-charged immediately to at least 50% capacity.
- 8.11. If the Device is not in use for longer periods of time (more than 1 week), make sure the battery is charged to at least 60% before it is powered down.
- 8.12. Protect the charging mating pads on the back of the Device from touching electrically conductive material / liquids or the Device might be short-circuited (and destroyed as consequence).

9. Carpe Iter Holder

- 9.1. The Carpe Iter Holder is specifically designed for the Device. Do not use the Holder for any other equipment than the Device.
- 9.2. The Holder will ensure secure mounting and will also provide continuous charging for the Device through the mating pads on the back on the Device.
- 9.3. The Holder includes a power source that was designed specifically for the Device. **DO NOT use the power source to power any other equipment than the Device.**
- 9.4. Description:

CARPE ITER

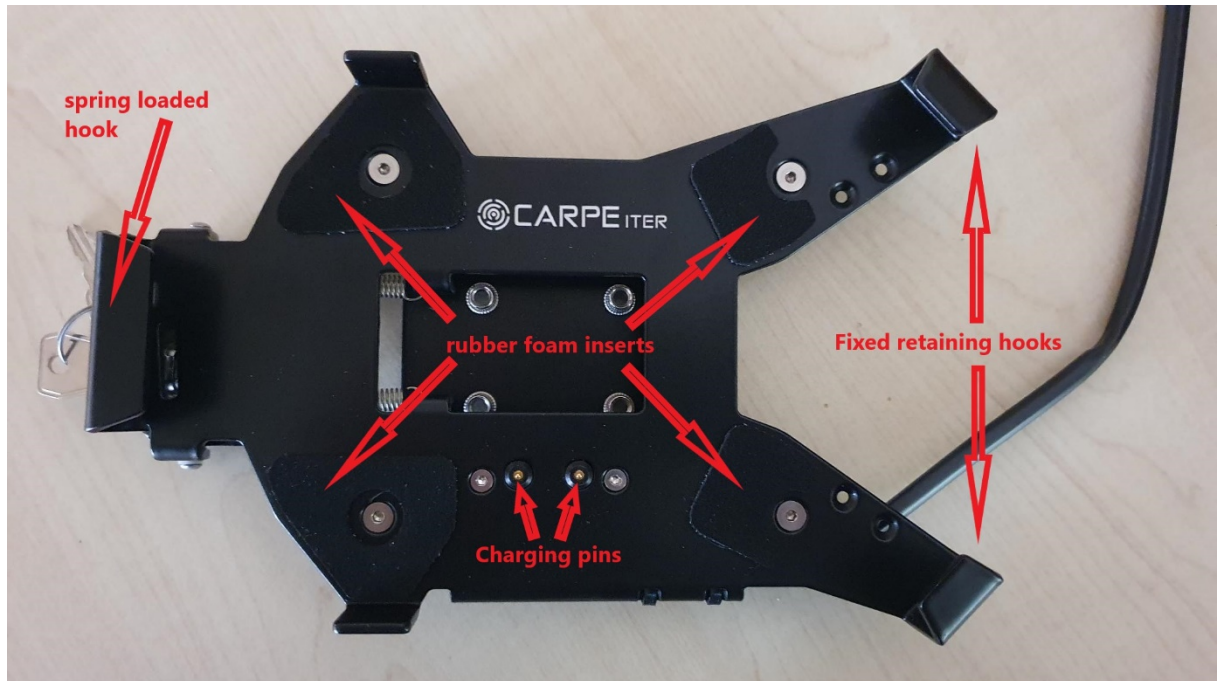

- 9.5. Holder installation requires at least basic mechanical and electrical skills. If you are in doubt, have the Holder installed by a professional workshop.
- 9.6. Protect the charging pins in the Holder from mechanical damage. Especially take care when inserting the Device into the Holder not to hit the charging pins with the Device – they could be damaged inside even if you cannot see any damage with naked eye. Damaged charging pins will cause charging problems (no charging or insufficient charging).
- 9.7. Protect the charging pins from being connected to one another with electrically conductive materials.
- 9.8. Mounting Holder
- 9.8.1. The base plate of the Holder contains 6 nuts for M5 screws. Screws are not included.
- 9.8.2. The mounting nuts create a standard AMPS hole pattern (30x38mm) in the landscape orientation.

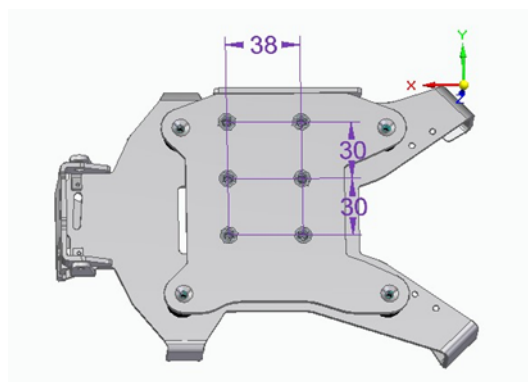

- 9.8.3. When Carpe Iter mounting brackets (paid accessory) are used, the Holder can be mounted horizontally and vertically.

- 9.8.4. The Holder must be mounted by at least 4 screws forming a rectangular shape to ensure stability and vibration resistance.
- 9.8.5. Whenever possible, mount the Holder as close to its centerline as possible (i.e. use mounting nuts in the center, not on the edge of the base plate).
- 9.8.6. The Holder and the Device have combined weight of approximately 1kg.
- 9.8.7. Make sure the Holder is mounted on a solid structure on your motorbike (handlebar or other support structure designed to carry heavy equipment) that can carry the weight of the Holder and the Device reliably.
- 9.8.8. It is imperative that Holder is mounted in such a way that engine vibrations and shocks from road are kept to minimum. Excessive vibrations and shocks in the Holder might cause a premature failure of the charging pins and / or of the Device. This applies especially, if you plan to use the Holder and the Device off the paved roads.
- 9.8.9. Mounting tips:
 - 9.8.9.1. Soft mounting style (e.g. Ram Mounts balls) is not recommended for motorcycles. If you must use this mounting style for some reason, use at least C size ball (1,5 inch);
 - 9.8.9.2. Although some motorcycles provide GPS mounting brackets (e.g. Yamaha T700), they might not be strong enough to support heavy equipment without additional reinforcement;
 - 9.8.9.3. Some aftermarket “rally” cockpits amplify engine vibrations because of their design, which can cause charging problems, premature charging pins failure and/or Device failure;
 - 9.8.9.4. In case excessive vibrations manifest in the Holder, consider adding extra dampening between the mounting point and the holder (rubber mat, rubber spacers, etc.);
 - 9.8.9.5. Standard aftermarket smart phone brackets are generally not strong enough to carry the combined weight of the Holder and the Device.

9.9. Inserting Device into Holder

- 9.9.1. Correct Device placement / orientation in the Holder (M8 charging connector is facing away from the spring-loaded retaining hook):



9.9.2. Never put the Device into the Holder in any other orientation than indicated above. It will prevent charging through the Holder and it will damage hardware buttons.

9.9.3. Correct Device inserting procedure:

9.9.3.1. **Close all port flaps properly** (see Section 4.5 and 4.6). If the flaps remain even slightly open when you insert the Device into the Holder, they will be damaged.

9.9.3.2. Open the spring-loaded retaining hook with one hand. With the Device slightly lifted, push the Device gently into the fixed retaining hooks with the other hand:



9.9.3.3. Make sure the Device is properly aligned with the locating elements on longer sides of the Holder;

9.9.3.4. Press the Device gently into the Holder. Close the spring loaded retaining hook;



- 9.9.3.5. If the Device was properly aligned and all port flaps are properly closed, very little force is required to insert the Device into the Holder. If the Device would not get inserted into the Holder easily, check the Holder for bends, check the Device for proper alignment, check that port flaps are closed properly and try again.
- 9.9.3.6. using the lock in the Holder is optional (the Device will not fall out of the Holder even when the lock is not engaged).
- 9.9.4. When properly inserted into the Holder, the Device will not **freely** move within the Holder. **DO NOT use force** to check, if the Device is too loose in the Holder (you might bend the Holder and/or damage the charging pins). If you feel the Device is loose in the Holder, check the Holder for bends, check rubber foam inserts for excessive wear. The rubber foam inserts are available as spare part. If the Device is too loose in the Holder, it can cause charging issues and premature failure of the charging pins in the Holder and/or Device failure due to excessive vibrations and shocks.
- 9.10. Maintenance
- 9.10.1. Regularly check for loose screws and torque them as required;
- 9.10.2. Regularly check the Holder for bends (especially after a crash). Bent Holder might not ensure correct charging and secure retention of the Device;
- 9.10.3. Regularly clean the charging pins with electrical contacts cleaner. It is recommended that you use a cleaner specifically designed to remove oxidation;
- 9.10.4. The charging pins are lubricated during production, so you do not need to apply a lubricant before first use;
- 9.10.5. Thoroughly lubricate the charging pins with electrical contacts oil or grease regularly and after each cleaning cycle (make sure the lubricant enters the charging pin body and does not stay only on the outside). Make sure that the lubricant (or the propeller agent in case of a spray) does not cause silicone degradation. In case of doubt, use silicone-based lubricants (the charging pins are sealed by a small silicone O-ring. If the O-ring is damage, it will negatively impact on the charging pin life and performance);

- 9.10.6. Use of electrical contact grease is recommended – make sure you push the grease inside the charging pin (compress the pin, apply grease. Compress the pin several times to make sure the grease enters inside the body of the pin). Using electrical contact grease will extend the charging pins life-span. It is NOT recommended that you use electrically *conductive* grease – it can cause short-circuit between the charging pins, if applied in excessive amounts;
- 9.10.7. All rubber and plastic parts and charging harness are considered a consumable –to retain proper function replace when necessary. All those items are available as spare parts.

10. Power source

- 10.1.1. **The CI Pad must never be connected to a power source with higher voltage level than 5,5V VDC (direct current).** CI Pad must not be powered by other than the provided USB wall charger or the Carpe proprietary power source. Failure to follow these instructions will void the warranty.
- 10.1.2. The power source included with the Holder contains 1 set of input wires and 2 connectors on the output. The output connectors may be connected to the Holder and M8 charging cable simultaneously:



- 10.1.3. M8 charging cable **must NOT be connected to a second power source**, when charging the Device from both the Holder and M8 charging connector, or it will damage or destroy the Device.

CARPE ITER

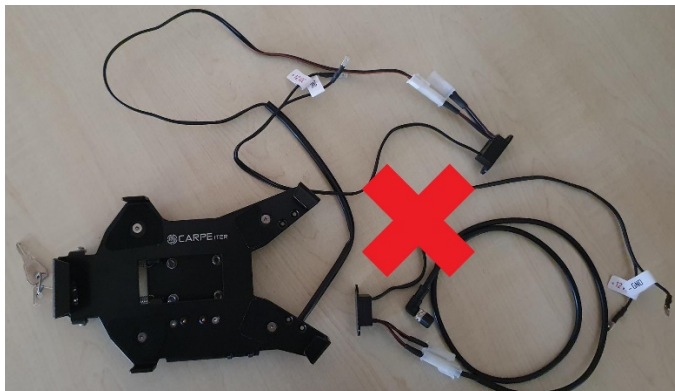

- 10.1.4. The power source requires direct current (DC) input with voltage exceeding 13,1 – 13,6V (there is 0,5V manufacturing tolerance) (the “**Switching Threshold**”). That is the voltage level a modern motorcycle or a car provides (exceeds) with engine running, **if it’s alternator is functioning correctly**. In case your vehicle cannot provide sufficient voltage to exceed the Switching Threshold under all engine operating conditions, Carpe also offers non-switching power source, which will provide power regardless of the voltage level in your vehicle electrical system (10-16VDC).
- 10.1.5. The power source will switch-off automatically when the input voltage drops below 12,9V to conserve your vehicle’s battery.
- 10.1.6. When voltage level exceeds the Switching Threshold, the power source will turn on within 30 seconds (soft start). Exceeding the operating voltage threshold will be indicated by a stable green LED on the power source.
- 10.1.7. Regardless the automated switching function of the power source, it is recommended that you connect it to your vehicles auxiliary power outlet linked to the ignition (the outlet is only powered, when ignition is ON).
- 10.1.8. If the power source is connected directly to the vehicle’s battery or “always on” auxiliary power outlet, our power source will turn on or will be caught in on/off cycle when you connect your vehicle to a battery charger. This frequent ON/OFF condition might cause premature power source failure. It is recommended that you disconnect our power source from your vehicle especially in case you keep the vehicle connected to a charger for extended periods of time (e.g. winter storage).
- 10.1.9. Before you start charging your vehicle’s battery, remove the Device from the Holder and disconnect the M8 charging cable from the Device.
- 10.1.10. NOTE: if you use LiFe battery in your vehicle and you connected the power source directly to the battery or “always on” auxiliary power outlet, the power source will not turn off when engine is stopped, because LiFe batteries have higher nominal voltage than standard led-acid batteries.
- 10.1.11. The power source requires that the electrical system of your vehicle can handle a stable power draw of at least 15W (approx. 1A at 14V).
- 10.1.12. If your vehicle cannot provide the minimum voltage required for the power source operation (13.6V), there is an alternative power source available as paid accessory, which will engage at 10V, but which will NOT provide a protection of the vehicle’s



battery against depletion in case you leave the Device charging in the Holder with engine stopped. Even a single full charge of the Device with engine stopped (and alternator not generating power) might deplete your vehicle's battery so deeply that you will not be able to start the engine.

- 10.1.13. The power source includes reverse polarity and over-heating protection. It will only provide overvoltage protection up to 20VDC on input (maximum voltage rating). Exceeding the maximum voltage rating will destroy the power source and, as a consequence, might also destroy the Device.
- 10.1.14. When installing the power source on your motor vehicle, make sure to connect the leads on the input in the correct polarity. The input leads are equipped with 6,3mm faston tab. Some motorcycles have the corresponding female sockets on their auxiliary power outlets. you can also connect the power source directly to the battery, but you will need to use cable extender **with a fuse** (5A fuse is recommended). **NEVER connect the power source directly to the vehicle battery without implementing a fuse.** When you connect the battery to your vehicle auxiliary power outlets, those should already be equipped with a fuse (check your vehicle specifications to verify this).
- 10.1.15. Battery extension cable with 5A fuse box and M6 loops that mates with our power source is available as optional accessory):



- 10.1.16. DO NOT change the stock connectors on the power source's output leads. Any tempering with wires and connectors on the output will void your warranty for both the Holder and the Device and we will NOT provide any assistance with debugging possible issues in such case.
- 10.1.17. The connectors on both the output and input of the power source are designed to be placed under your vehicle's mask or fairing and be protected from elements that way. In case it is not possible on your vehicle, wrap the connectors with e.g. black electrician's tape after installation to prevent short circuit from water ingress.
- 10.1.18. It is recommended that you apply electrical contact grease on all connectors between Holder and power source and between the power source and your vehicle.
- 10.1.19. The power source can be operated in ambient temperatures up to 60°C. The output current generated by the power source might decrease, when ambient



temperature exceeds 50°C. Do not place the power source close to your vehicle's engine or cooling radiators, or overheating can occur.

11. Troubleshooting

11.1. Software issues:

- 11.1.1. If the Device is malfunctioning or you are experiencing application crashes or hangs, reboot and/or reset the Device (press Reset button);
- 11.1.2. If the unwanted behavior does not improve, perform Factory reset (this will, however, wipe all your data and delete all installed applications) or follow instructions given by Carpe Tech support. Support ticket can be filed here: <https://carpe-iter.com/support/ticket/>
- 11.1.3. If the issue concerns a third party app, contact the application developer and report the problem (third party applications are beyond our control and most issues require to fix a bug contained in that third party application);
- 11.1.4. If the crashes or other unwanted behavior relates to Carpe Iter applications, file a Support Ticket on our website (<https://carpe-iter.com/support/ticket/>).

11.2. GPS does not lock position:

- 11.2.1. reboot the Device;
- 11.2.2. make sure GPSTune app is installed and running (if available for the specific generation of your Device). On v4b generation, the GPS related services are embedded in the Manager app (there is no self-standing GPSTune app on v4b generation);
- 11.2.3. if you disabled Location services in System settings, enable Location services and **reboot the Device** (rebooting is necessary after cycling Location services disable/enable);
- 11.2.4. achieving position lock requires that GNSS satellites are in view and not obstructed by materials/structures impenetrable by the satellites' signal. Therefore, positioning services will not be available inside most buildings and may be compromised by difficult conditions, such as deep valleys or streets surrounded by tall buildings (city canyons). When performing a GPS position test, go outside where there is a good sky-view. First position lock after longer period of idle or after significantly changing location after last position lock might take longer time, especially if the Device is not connected to internet (up to 10 minutes to achieve first position lock. Subsequent position locks should be much faster). If position lock is not achieved under the aforesaid conditions, contact our support team;

11.3. GPS position lock is unreliable (real location is far off or is "jumping"):

- 11.3.1. Turn off Google Location Accuracy improvement (it actually does not improve position in many cases / not reliably):

CARPE ITER

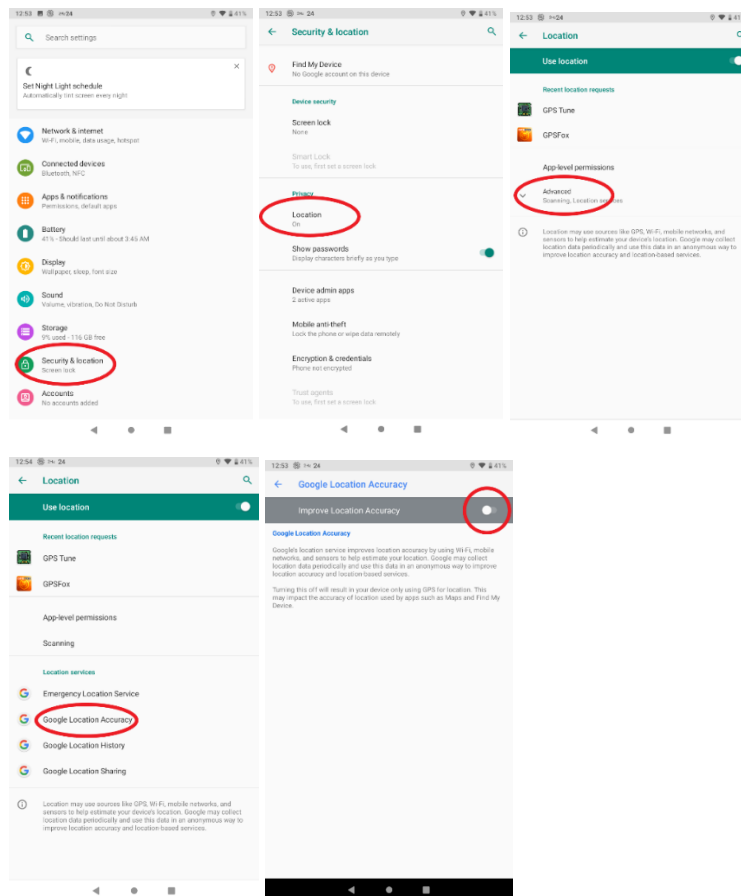

11.3.2. Make sure you have good sky-view (location accuracy might degrade in difficult terrain, such as deep valleys, steep slopes, high surrounding buildings, ...);

11.3.3. Make sure the GPS antenna is not covered. When the Device is in Portrait, make sure the antenna is facing up:

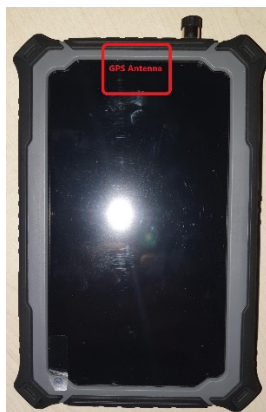

11.4. Device does not start:

11.4.1. make sure the Device is charged. Connect the Device to the provided USB wall charger. The Device will automatically start when connected to charging. If the charging icon does not appear within 3 hours of charging (the battery might be



CARPE ITER

deeply discharged and it will take time for it to exceed minimum voltage threshold), disconnect from the charger and contact customer support;

- 11.4.2. press Reset button and power up CI Pad again;
- 11.4.3. connect the Device to Internet. Let GPSTune or Carpe Manager (depending on the version of your Device) download assistance data for the GPS Chip. Alternatively, wait 15-20 minutes for the GPS chip to download assistance data from GNSS satellites automatically.
- 11.5. Device shuts down immediately after starting: battery is depleted - charge it;
- 11.6. Device shuts down immediately after starting even when connected to charging: battery is depleted. Keep the device connected to charging and immediately after system boots reduce screen brightness or turn screen off (short press on Power button) – LCD drains a lot of power, which causes the battery to drop below minimum voltage operating threshold and subsequent automatic shut-down.
- 11.7. Device does not charge (charging is NOT indicated on the System Bar and Carpe Manager app - Power&Charge tab, although the Device is connected to a power source – USB charger/Holder/M8 charging cable):
 - 11.7.1. USB port: make sure you use correct and properly functioning USB charger. Check that the wall socket you use is actually supplied with electricity;
 - 11.7.2. Holder/M8 charging cable:
 - A. Power source does not show green LED: check voltage on the input of the power source. It needs to be above the Switching Threshold (13,6V). Possible causes: engine not running, bad alternator, burnt fuse, broken wire, bad contact. In case your vehicle cannot provide sufficient voltage to exceed the Switching Threshold under all engine operating conditions, Carpe also offers non-switching power source, which will provide power regardless of the voltage level in your vehicle electrical system (10-16VDC);
 - B. Power source does not show green LED, voltage on input of the power source is above Switching Threshold (13,6V): check polarity, wait for 30 seconds (the power source does not start immediately – that is normal behavior). In case your vehicle cannot provide sufficient voltage to exceed the Switching Threshold under all engine operating conditions, Carpe also offers non-switching power source, which will provide power regardless of the voltage level in your vehicle electrical system (10-16VDC);
 - C. Power source shows green LED, but the Device is not charging (no charging indication on the System Bar and in the Carpe Manager app):
 1. check connection between Holder and power source;
 2. try to use M8 charging cable. If charging is possible through the M8 charging cable, the charging pins in the Holder are damaged or wire between the power source and Holder broken. In rare cases internal wiring in the Device was damaged due to excessive vibrations. Holder charging harness including the charging pins is available as spare part, which can be installed by the user. If the charging issue is caused by



damaged internal wiring in the Device, the Device can be sent to Carpe Iter for repair (fee may be charged for the repair);

11.8. Device does not charge sufficiently (battery level goes down, but active charging **IS** indicated on the System Bar and Carpe Manager app - Power&Charge):

- 11.8.1. check your current consumption. If it **on average** (occasional spikes should not matter) exceeds 2A, shut down some of the running apps and processes to bring the consumption down (charging limitation of the Device is 2A). Current consumption can be checked in the Carpe Manager – Power&Charge tab or system pull-down menu, **while the Device is disconnected from charging**.
- 11.8.2. lift the Device from the Holder and put it back. It will let the charging pins in the Holder re-align. you do not need to remove the Device from the Holder completely – it is enough to lift one side at the spring-loaded hook (the moving part) to break contact with the charging pins and place it back.
- 11.8.3. **clean the Holder charging pins**. Refer to Section 9.10.3 and 9.10.6. If cleaning the pins does not help, they might be worn out. Replace charging harness in the Holder (available as spare part);
- 11.8.4. check all cables for broken leads. Check and clean all connectors between the holder and your bike (unplug, apply contacts cleaner followed by electrical contacts grease and re-plug);
- 11.8.5. check AC ripple voltage on your vehicle (oscilloscope and electricians skills are required – have a professional workshop perform the check). If the AC ripple voltage exceeds 100mV, it might affect proper function of the Holder power source. Ripple voltage exceeding 100mV could indicate bad alternator/DC rectifier in your vehicle.

11.9. System battery level indicator seems wrong:

- 11.9.1. System battery level indicator will not match voltage level indicated by the Carpe Manager most of the time. That is normal.
- 11.9.2. The Carpe Manager app charging algorithms will attempt to calibrate the battery level indicator automatically (see Section 7.14).
- 11.9.3. Wrong readings from System battery level indicator have no negative impact on normal use of the Device.
- 11.9.4. System battery level indicator is for general orientation only. The only measurement relevant for actual battery level is battery voltage, which can be checked in the Manager app - Power&Charge tab.

12. Disclaimer

12.1. Unless explicitly stated for a specific Carpe Iter item (the Device, Holder, their accessories, brackets and other Carpe Iter equipment) ("**Item**") otherwise, no testing or homologation procedures were taken to ensure compliance with regulations associated with using the Items in regular traffic – on the streets. Use at your own risk.



- 12.2. Make sure that Items with sharp edges are positioned so that the sharp edge does not face the rider. Always dismount Items, which you are not currently using – especially empty holders and brackets (which may form a sharp edge, when empty).
- 12.3. Even if the Items are mounted to your vehicle properly, you might suffer an injury to your body (bruises, tearing, fractures, etc.) or damage to your gear (tearing, breakage, etc.) especially in case of an accident (e.g. dismounting your vehicle in other than standard way).
- 12.4. Manuals and use instructions are only provided in electronic form and can be viewed and/or downloaded on our website. Manuals and instructions for use shall not be provided in printed form.
- 12.5. Our manuals and instructions for use assume casual experience with smart devices (such as smartphones) and basic manual dexterity. In case of doubt, installation of Items on a vehicle must be performed by a specialized workshop.
- 12.6. Manuals and instructions for use, as well as technical support are only provided in English.

13. Manufacturer's Warranty

- 13.1. We provide world-wide warranty in the scope set forth below for defects, which exist upon delivery of an Item to the shipping address provided by you upon purchase and which shall manifest within the period of 2 year as of the date of the original purchase, if you are a consumer, and 1 year as of the date of the original purchase, if you are a business (you provided business identification number or VAT number upon purchase). This warranty does not apply to software and batteries (see below). The date of dispatch of an Item to your shipping address is deemed to represent the date of original purchase.
- 13.2. Limited 6 months warranty is provided for batteries included in an Item or batteries sold separately. In the course of this limited battery warranty we guarantee that the battery will retain at least 60% of its nominal capacity. No warranty is provided for batteries beyond the period of 6 months following the date of original purchase. Warranty for batteries is subject to adhering to the use instructions set forth above.
- 13.3. Our warranty only covers defects that preclude the use of the Item for its purpose. In view of the intended purpose of use of Items, our warranty does not cover, in particular, defects of cosmetic nature, such as discoloration, paint fading, rusting that does not hinder the use, etc.
- 13.4. Our warranty is subject to adhering to manuals and use instructions published on our website or stated above in this manual. Our warranty does not cover defects occurring due to misuse and lack of maintenance.
- 13.5. No warranty is provided for software.
- 13.6. No warranty is provided for defects occurring as a result of outside forces (abrasion, shock, water, pressure, vibration, UV light, etc.).
- 13.7. Plastic and rubber parts of Items are considered expendable material.
- 13.8. Item, in respect of which our defect warranty is claimed, including a detailed written description of the defect, must be delivered for inspection to the address of our seat or other address published for that purpose on our website. Any and all cost associated with the delivery, including without limitation fees and other duties incurred by us in association



with re-importing the Items into EU, will be borne by you and we will be entitled to request the respective reimbursement to be credited to our bank account before your warranty claim is processed.

- 13.9. We shall be free to choose any of the following actions to satisfy your warranty claim:
- 13.9.1. repair, if repair is economical;
 - 13.9.2. adequate monetary compensation;
 - 13.9.3. replacement of the defective Item.
- 13.10. We may always choose to replace a defective Item instead of carrying out a repair or providing monetary compensation.
- 13.11. your warranty claim shall be reviewed and responded to within 30 days following the delivery of the defective Items our address provided by us for that purpose.
- 13.12. It is strongly recommended that you contact us by email before dispatching an Item, in respect of which you plan to claim warranty. We might choose to satisfy your claim without the need to return the defective Item, which will save time and shipping cost.