

# F007-II

## Fingerprint Access Control

User Manual

## Contents

<b>1. Introduction</b>	1
<b>2. Functions</b>	1
2.1 Sleeping function	1
2.2 Manager fingerprints operation function	1
2.3 Lock driving function	1
2.4 Anti-tamper alarm function	1
<b>3. Intramural Interface Circuit</b>	1
<b>4. Installation, Wiring and Fix</b>	2
4.1 Installation	2
4.2 Wiring Definition	3
4.3 Common Power Supply Connection Diagram	3
4.4 Special Power Supply Connection Diagram	4
<b>5. Programming Guide</b>	5
5.1 User Settings	5
5.2 Door, Alarm	6
<b>6. Sounds and Lights</b>	7
<b>7. Reset to Factory Default</b>	7
<b>8. Technical Specification</b>	8
<b>9. Packing List</b>	8

## 1. Introduction

F007-II is the updated version of F007, with highly improved performance. It is a metal shell standalone fingerprint access control, using the Atmel's MCU, with precise electron circuit and good productive technology.

The F007-II uses the most advanced fingerprint identification technology, which is an ideal choice for the occasions with high security requirements, suitable for business affairs organization, office, factory, housing district etc.

Its programming is done by the infrared remote control or manager fingerprints. It can store 1,000 fingerprints, includes 2 manager fingerprints, 998 user fingerprints, and each fingerprint has one ID number.

## 2. Functions

### 2.1 Sleeping function

High environmental awareness energy-saving control system, with auto sleeping and waking up function, and the sleeping power consumption is  $\leq 0.20W$ .

### 2.2 Manager fingerprints operation function

The machine can add / delete the users' fingerprints by manager fingerprints quickly, which is very convenient.

### 2.3 Lock driving function

With NC, NO and COM, the control time is 0~99s (0s is 50ms actually).

### 2.4 Anti-tamper alarm function

When the machine is disassembled illegally, the buzzer will sound a consecutive alarm, and it will remove automatically after 1min.

## 3. Intramural Interface Circuit

The machine is with a built-in relay, the NO, COM and NC wires are isolated from the inner electro circuit. The contactor's current is 2A.

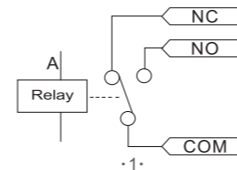

## 4. Installation, Wiring and Fix

### 4.1 Installation

- > Remove the back cover using the supplied security driver
- > Drill 4 holes on the wall and fix the back cover
- > Thread the wires through the wire hole
- > Attach the front cover to the back cover

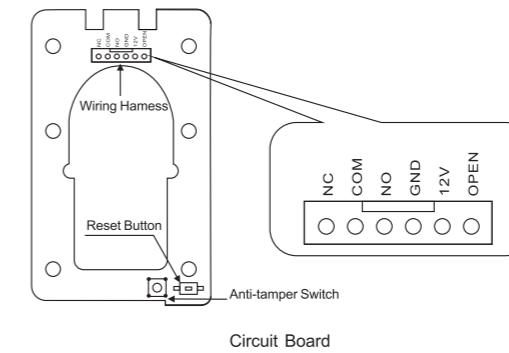
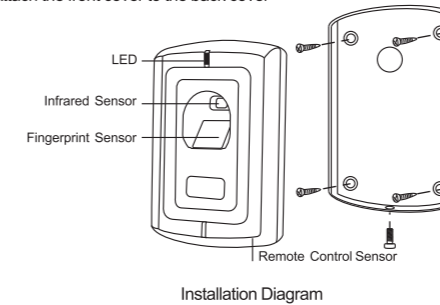

-2-

### 4.2 Wiring Definition

Wiring Function	Wire Color	Notes
OPEN	Yellow	Request to Exit Button
+12V	Red	+12V Power Input
GND	Black	GND
NO	Blue	Relay Output NO
COM	Purple	Relay Output COM
NC	Orange	Relay Output NC

### 4.3 Common Power Supply Connection Diagram

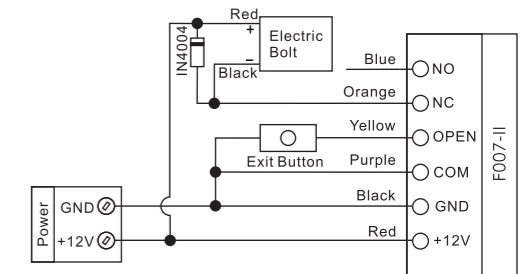

Here are some lock wirings bases on different locks

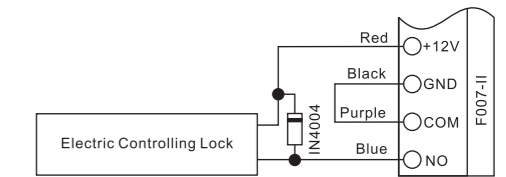

-3-

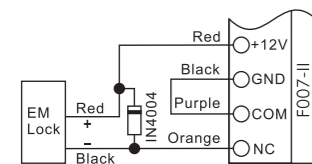

Install an IN4004 or equivalent diode is needed when use a common power supply, or the reader might be damaged. (IN4004 is included in the packing)

### 4.4 Special Power Supply Connection Diagram

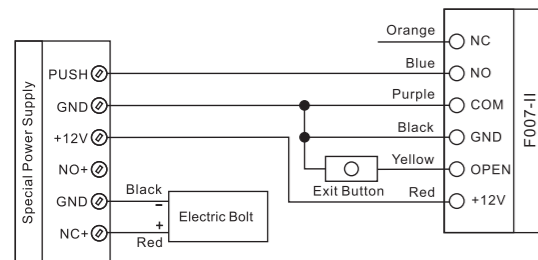

Here are some lock wirings bases on different locks

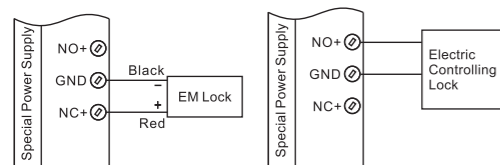

-4-

## 5. Programming Guide

### 5.1 User Settings

To enter the programming mode

\* master code # 9999 is the factory default master code

To exit from the programming mode

\*

**Note:** All the steps below must be done after enter into programming mode

To change the master code

0 new code # new code # The master code is any 4 digits

To add / delete user

**(Method 1)** The most convenient way.

**To Add User**

7 | input fingerprint twice | #

**To Delete User**

8 | input fingerprint once | #

Can add / delete fingerprints continuously without exiting programming mode

**(Method 2)** This is the optional way to add fingerprints using User ID Allocation. In this method, a User ID is allocated to a fingerprint.

**To Add a User**

1 | user ID number | # | input fingerprint twice | #

**To Add Users Continuously**

1 | 3 | # | 1<sup>st</sup> user fingerprint twice | 4 | # | 2<sup>nd</sup> user fingerprint twice

... | N | # | N<sup>th</sup> user fingerprint twice | #

**To Delete a User**

2 | user ID number | #

**To Delete Users Continuously**

2 | user ID number | # | user ID number | # | ... user ID number | #

The ID number is any number between 3 ~ 1000.

-5-

**(Method 3)** By manager add/delete fingerprint

**To Add Manager Add / Delete Fingerprint**

1 | 1 | # | input fingerprint twice | 2 | # | input another fingerprint twice | #

ID number 1: Manager Add Fingerprint, to add the users

ID number 2: Manager Delete Fingerprint, to delete the users

**To Add a User** (done out of programming mode)

input Manager Add Fingerprint | input user fingerprint twice | repeat Manager Add Fingerprint

**To Add Users Continuously** (done out of programming mode)

input Manager Add Fingerprint | 1<sup>st</sup> user fingerprint twice | 2<sup>nd</sup> user fingerprint twice | ... | N<sup>th</sup> user fingerprint twice | Repeat Manager Add Fingerprint

**To Delete a User** (done out of programming mode)

input Manager Delete Fingerprint | input user fingerprint once | Repeat Manager Delete Fingerprint

**To Delete Users Continuously** (done out of programming mode)

input Manager Delete Fingerprint | 1<sup>st</sup> user fingerprint once | 2<sup>nd</sup> user fingerprint once | ... | N<sup>th</sup> user fingerprint once | Repeat Manager Delete Fingerprint

To delete All users

2 | 0000 | # Note: This is a **dangerous** option, so use with care

### 5.2 Door, Alarm

To set door open time

4 | 0~99 | # Factory default is 5s (0s is 50ms actually)

-6-

To release alarm

input Manager Add/Delete Fingerprint | or input user's fingerprint | or input master code

To unlock the door

Put the finger on the fingerprint sensor for 1s

## 6. Sounds and Lights

Operation Status	Indicator Light Color	Finger Sensor Light	Buzzer
Power On	Slow Shine in Red	Bright	Long Ring
Sleeping	Slow Shine in Red	Goes Out	
Voided Key			Short Ring
Enter Programming	Red	Goes Out	Long Ring
Programming	Orange		
Input Fingerprint Successful	Green		Long Ring
Input Fingerprint Failed			3 Short Rings
Unlock the Door	Green	Goes Out	Long Ring
Alarm	Quick Shine in Red	Bright	Long Ring

## 7. Reset to Factory Default

To reset to factory default, power off, press "RESET" button on the PCB, hold it and power on, release it until hear three short beeps, means to reset to factory default successfully.

Remark: Reset to factory default, the users' fingerprints enrolled is still retained.

-7-

## 8. Technical Specification

Input Voltage	DC 12V±10%
Sleeping Current	≤20mA
Idle Current	≤80mA
Door Relay Contact Load	2A
Operating Temperature	-10°C~50°C
Operating Humidity	20%RH-95%RH
Fingerprint Capacity	1000
Resolution	450 DPI
Fingerprint Input Time	<1S
Identification Time	<1S
FAR	<0.0000256%
FRR	<0.0198%
Case	Zinc Alloy
Dimension	115mm×70mm×35mm
Weight	500g

## 9. Packing List

Name	Qty	Remark
Fingerprint Access Control F007-II	1	
Infrared Remote Control	1	
User Manual	1	
Screw Driver	1	
Diode	1	IN4004
Self Tapping Screws	4	Φ4mm×25mm
Rubber Bungs	4	Φ6mm×25mm

-8-