



# SUN2000-450W-P Power Optimizer Application Note for HUAWEI Residential & Commercial Inverter

This document is to introduce HUAWEI SUN2000-450W-P power optimizer application method to:

**Table 1**

|                                  | Model Number                   |
|----------------------------------|--------------------------------|
| Single phase smart energy center | SUN2000-2/3/4/4.6/5/6KTL-L1    |
| Three phase smart energy center  | SUN2000-5/6/KTL-M1             |
| Three phase smart PV inverter    | SUN2000-8/10/12/15/17/20KTL-M2 |

## 1. Full Power Optimizer Application Instruction

SUN2000-450W-P power optimizer support fully deployment to all inverter listed in Table-1.

The number of power optimizer connected per string shall meet the long string design requirement in Table-2. (Please consider local installation rules for the string configuration with SUN2000-450W-P optimizer)

|                                     | SUN2000-2-6KTL-L1 | SUN2000-5-6KTL-M1 | SUN2000-8-20KTL-M2 |
|-------------------------------------|-------------------|-------------------|--------------------|
| Minimum optimizer number per string | 4                 | 6                 | 6                  |
| Maximum optimizer number per string | 25                | 50                | 50                 |

|                             |         |          |          |
|-----------------------------|---------|----------|----------|
| Maximum DC power per string | 5,000 W | 10,000 W | 10,000 W |
|-----------------------------|---------|----------|----------|

1) For SUN2000-2/3/4/4.6/5/6KTL-L1 and SUN2000-5/6KTL-M1 inverter Each inverter has two MPPT trackers and each tracker has one string input. When applying full optimizer to each string:

- PV modules made in different model, from different manufacture or installed in different orientation, shading area can be attached to the power optimizer connected in the string.

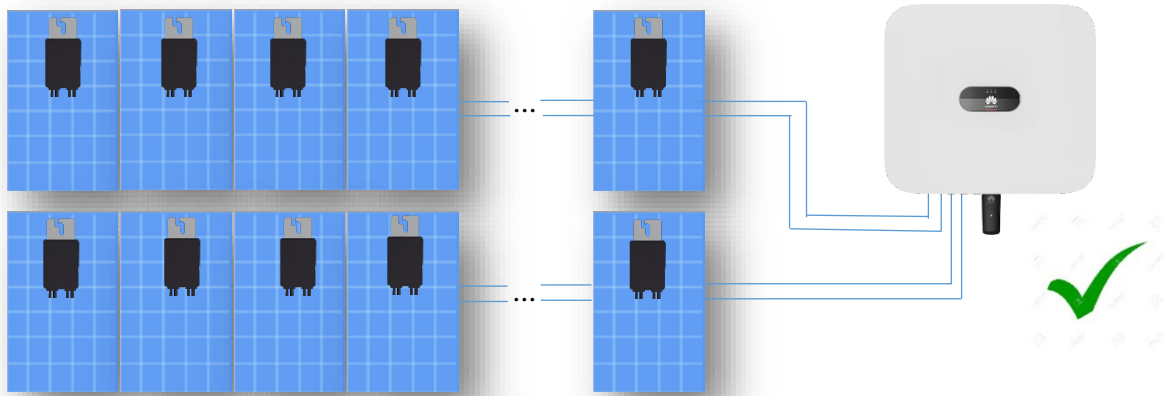

- The number of PV modules in each string can be different.

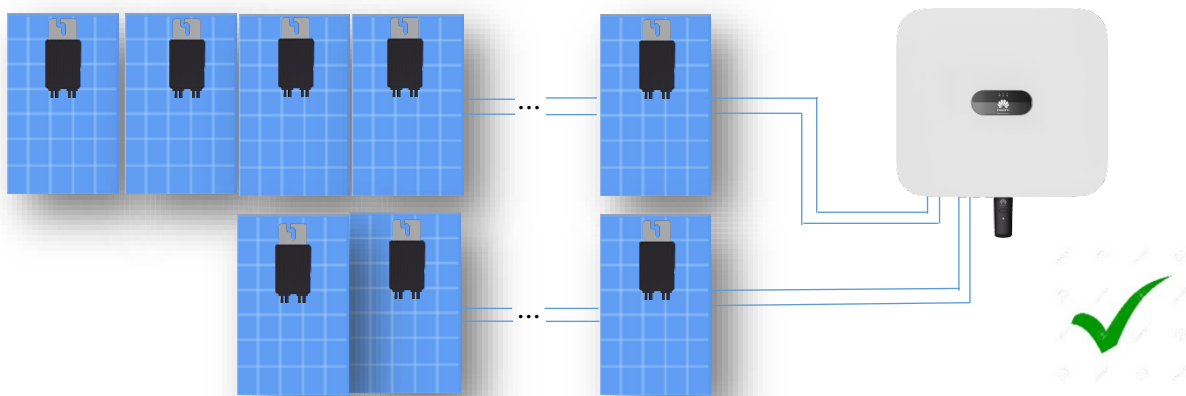

2) For SUN2000-8/10/12/15/17/20KTL-M2 inverter, it has two MPPT trackers and each tracker has two string inputs connected in parallel. Full optimizer deployment has

following restriction when connecting PV modules to both string inputs of each MPPT tracker:

- PV module quantity in each string of a MPPT tracker must be identical.

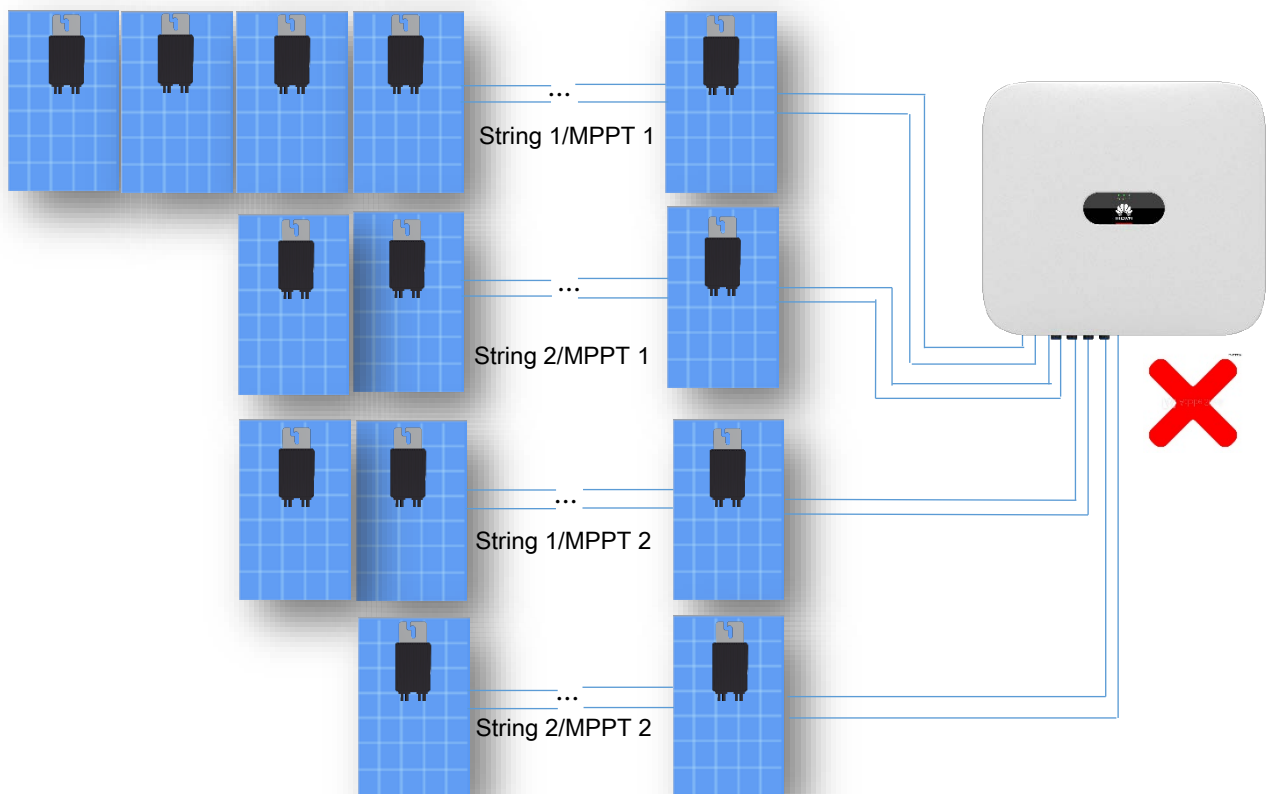
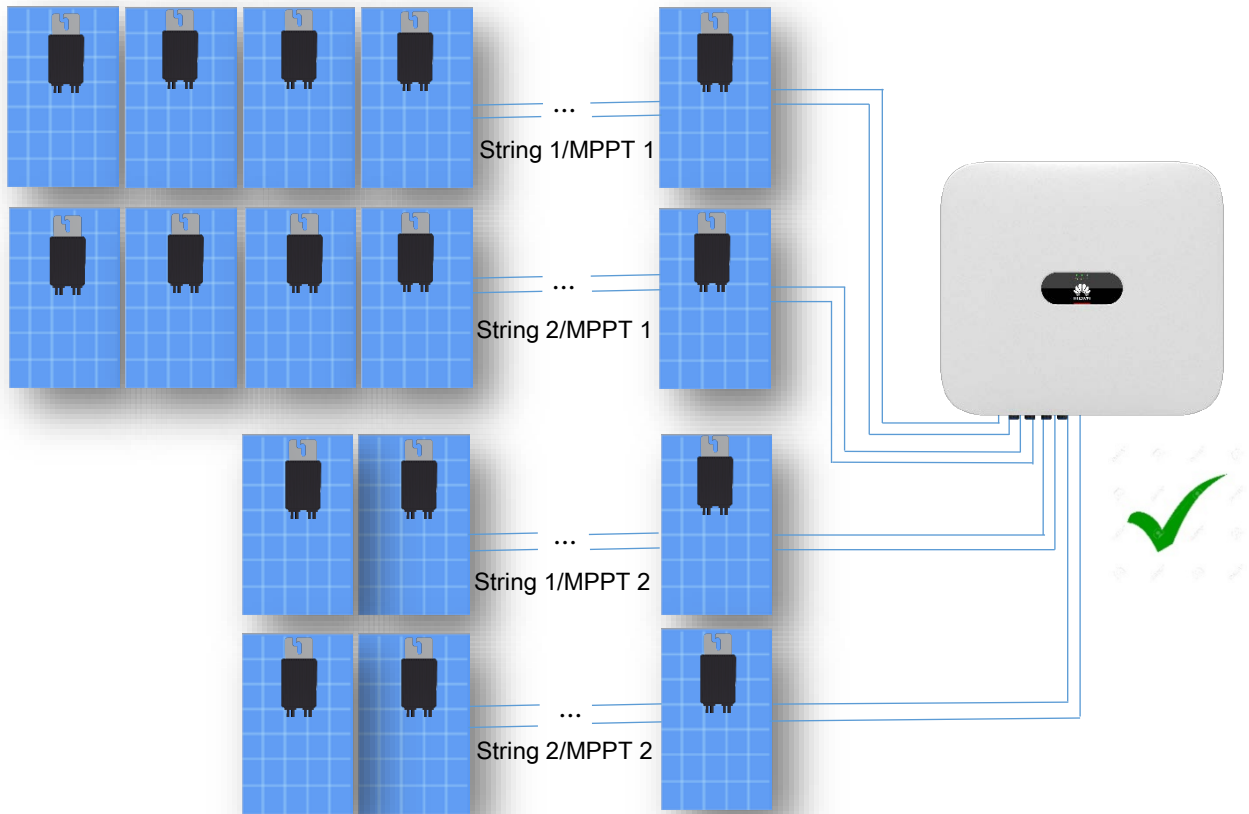

- All PV modules connected to both strings of a MPPT tracker must be in the same model number and from the same manufacture.
- All PV modules connected to both strings of a MPPT tracker must be installed in the same azimuth and tilt.

### Recommended Design:

- If total PV module power capacity is lower or equal to 20KWp, connect only one string of each MPPT tracker and keep the power capacity of PV module connected to the string to be lower or equal to 10KW. For example, for a 18KWp PV system, connect 10KWp PV modules to one string of MPPT 1 and connect 8KWp PV modules to one string of MPPT2 of the inverter. In this way, PV modules made in different model, from different manufacture or installed in different orientation, shading area can be attached to the power optimizer connected in the string.

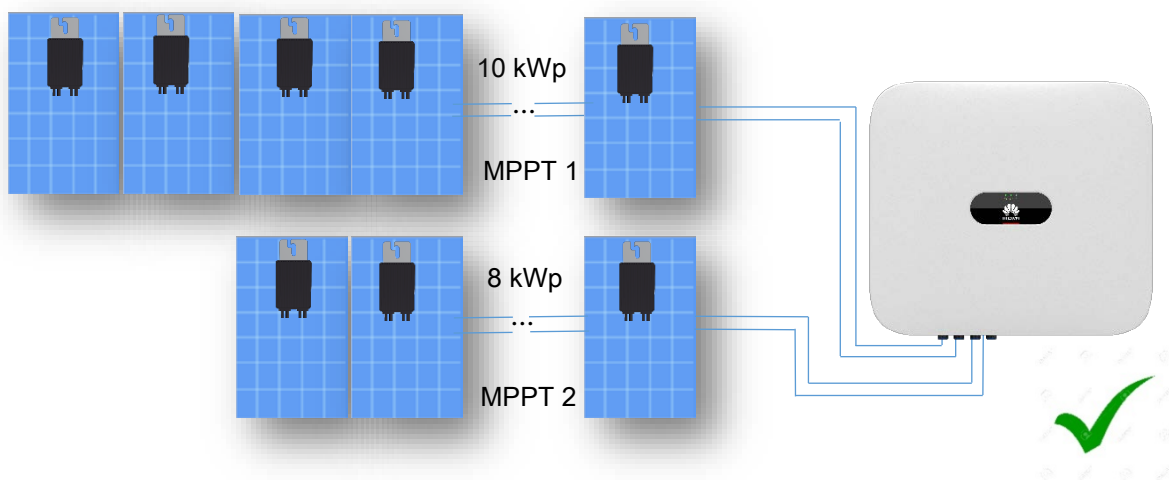

- If total PV module power capacity is higher than 20KWp, keep 10KWp PV modules connect to only one string of the first MPPT tracker. Then split the rest PV modules into

two groups with the same quantity and connect each group of PV modules to two strings of the second MPPT tracker. For example, for a 24KWp PV system, connect 10KWp PV modules to one string of MPPT 1. Then connect 7KWp PV modules to one string of MPPT 2 and connect 7KWp PV modules to the other string of MPPT 2. PV module quantity in each string of the second MPPT tracker must be identical and all PV modules connected in both strings must be in the same model number, from the same manufacture and installed in the same azimuth and tilt.

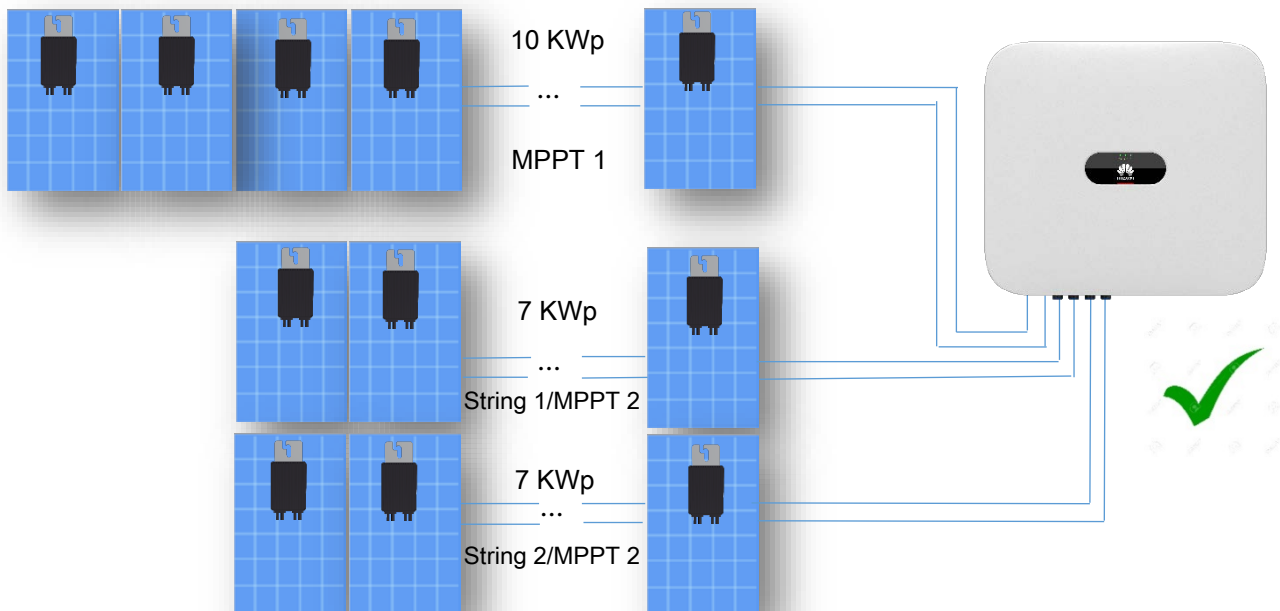

## 2. Partial Power Optimizer Application Instruction

1. For SUN2000-2/3/4/4.6/5/6KTL-L1 and SUN2000-5/6KTL-M1 inverter: Inverter has one two MPPT trackers and each tracker has one string input. SUN2000-450W-P power optimizer can also be partially deployed in the string.

- The number of power optimizer connected in the string can be between one to total number of PV modules in the string.
- PV modules design rule is the same to no optimizer design. The number of PV modules connected in the string limited by both inverter max input voltage and Voc of PV modules with taking lowest temperature coefficient into account.
- PV modules connected to power optimizer can be installed in different azimuth and tilt.
- The PV module number and manufacture shall be same when connecting to power optimizer.

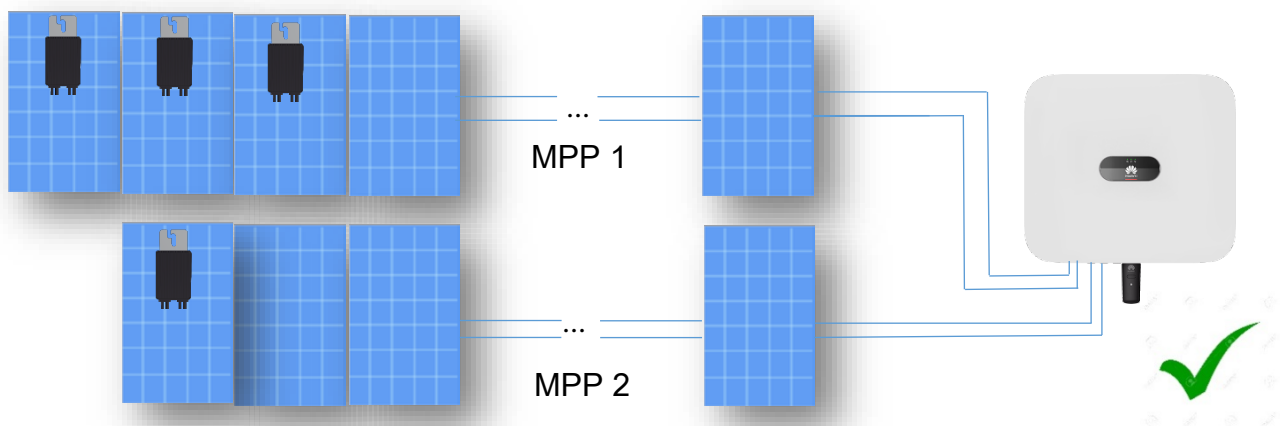

2. For SUN2000-8/10/12/15/17/20KTL-M2 inverter, inverter has two MPPT trackers and each tracker has two string input connected in parallel.

- When each MPPT tracker has only one string connected with PV modules, partial optimizer deployment is supported in the string in the same way as SUN2000-2/3/4/4.6/5/6KTL-L1 and SUN2000-5/6KTL-M1 inverter
- When connecting PV modules to both strings of each MPPT tracker, partial power optimizer deployment is not supported.

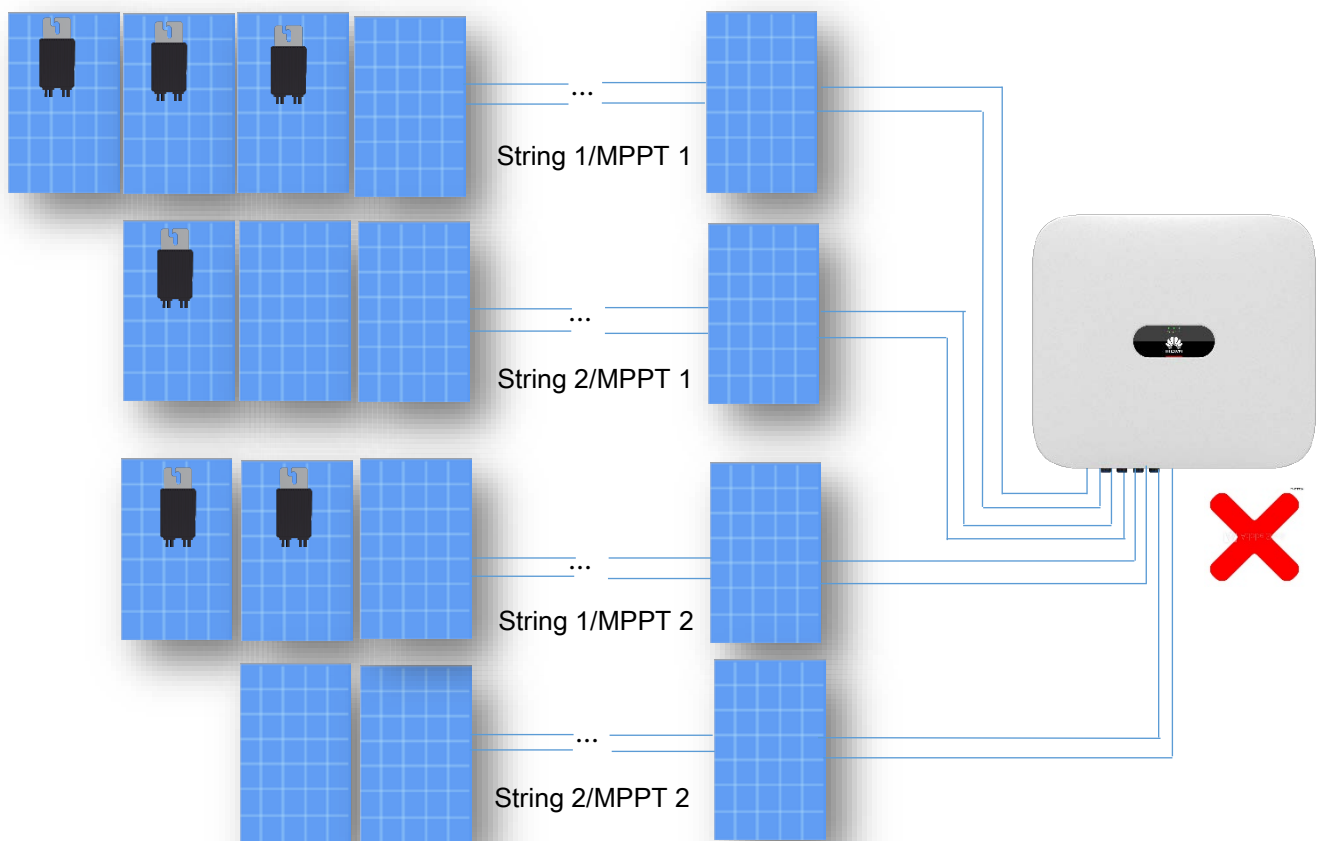

3. Whenever partial optimizer is designed in the system, following features will NOT be available:
- Flexible long string design;
  - High DC voltage rapid shutdown;
  - Arc fault pinpoint positioning;