

Hickory Rotisseries

Model: N/5.7 G



Voltage: 120V single phase, Amps: 3, Hz: 60

Cooking burners: 2 Pressurized burners

BTU's / Cooking Burner: 36,000 Natural
20,000 Propane

Show Burner: 20,000 Natural or Propane

Manifold Pressure: 5.5 in W.C. Natural
11 in W.C. Propane

Minimum Installation Clearance:

3 Inches sides and back. 15 inches rear with glass door in back

Lamps should be replaced with 120V, 40W rated bulbs or equivalent

Specifications and manual subject to change without notice

Orifice Size

#32

#48

(3)#53 / #48

(LEFT BLANK INTENTIONALLY)

Please copy, cutout and place in a prominent location.

What To Do If You Smell A Gas Odor

Natural gas is lighter than air, and it has a very high ignition temperature. For your protection, The Gas Company adds a distinctive odor to natural gas, so leaks are easily detected.

If you smell a Natural gas or a Propane gas odor:

- **DON'T panic.**
- **DON'T light a match, candle or cigarette.**
- **DON'T turn electrical appliances or lights on or off.**

For safety, a shut-off valve was installed on this appliance. If a leak occurs at this appliance, the valve will permit you to turn off the gas at the appliance rather than shutting off all gas service at the meter.

SHUT off the appliance shut-off valve.

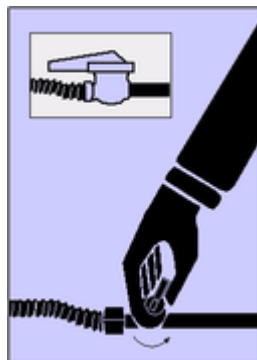

From a safe location, call your local Gas Company 24 hours a day, seven days a week; or call **9-1-1**.

S'il vous plaît copier, découper et placer dans un endroit bien en vue.

Que faire si vous sentez une odeur de gaz

Le gaz naturel est plus léger que l'air , et il a une très haute température d'allumage . Pour votre protection, La Compagnie du Gaz ajoute une odeur caractéristique du gaz naturel , de sorte que les fuites sont facilement détectées.

Si vous sentez un gaz naturel ou une odeur de gaz propane :

- **Ne paniquez pas.**
- **NE PAS allumer une allumette , bougie ou cigarette.**
- **NE PAS tourner les appareils électriques ou les lumières ou désactiver.**

Pour plus de sécurité , une soupape d'arrêt a été installé sur l'appareil. Si une fuite se produit à cet appareil , la vanne vous permettra de couper le gaz à l'appareil plutôt que couper tous les services de gaz au compteur.

Fermez le robinet d'arrêt appareil.



D'un endroit sûr , appelez votre compagnie de gaz locale 24 heures par jour , sept jours par semaine ; ou composez le 9-1-1.

FOR YOUR SAFETY

Do Not Store or use gasoline or other flammable vapors or liquids in the vicinity of this or any other appliance.

It is important to keep the appliance area free and clear from combustibles

WARNING: Improper installation, adjustment, alteration, service or maintenance can cause property damage, injury or death. Read the Installation, operating and maintenance instructions thoroughly before installing or servicing this equipment.

POUR VOTRE SÉCURITÉ

Ne pas entreposer ou utiliser de l'essence ou d'autres vapeurs ou liquides inflammables au voisinage de cet appareil ou de tout autre appareil.

Il est important de garder la zone de appliance libre et claire des combustibles

AVERTISSEMENT: Une mauvaise installation , le réglage , la modification, un service ou d'entretien peut causer des dommages matériels, des blessures ou la mort. Lire l' installation , l'exploitation et la maintenance instructions avant l'installation ou l'entretien de cet équipement.

MINIMUM INSTALLATION CLEARANCES
ARE 3 INCHES FROM THE SIDES AND 3 INCHES FROM THE BACK
WITH GLASS BACK IT SHOULD BE 15 INCHES FROM THE BACK
FOR INSTALLATION ON A COMBUSTIBLE FLOOR

Dégagements minimum d'installation
SONT 3 pouces du CÔTÉS ET 3 POUCES DU RETOUR
AVEC VERRE RETOUR IL DEVRAIT ÊTRE 15 POUCES DU RETOUR
POUR L'INSTALLATION SUR UN PLANCHER COMBUSTIBLE



As a safety precaution, disconnect the power supply to the appliance before cleaning or servicing this appliance.



Par mesure de sécurité, débrancher l'alimentation électrique l'appareil avant le nettoyage ou l'entretien de cet appareil.

Instruction Plate:

Before lighting this piece of equipment, ensure that the ventilation hood is turned on

1. Set pilot valve with screwdriver to provide 1/2" flame by turning pilot valve counterclockwise
2. Light corresponding pilot light with a match or long match
3. After pilot lights have been lit, turn desired valve "ON".

NOTICE: In order to be able to service this appliance, it must be installed with the casters supplied, a connector complying with **ANSI Z21.69** or **CAN/CGA-6.16** and a quick-disconnect device complying with **ANSI Z21.41** or **CSA-6.9**. It must also be installed with restraining means to guard against transmission of strain to the connector as specified in the appliance manufacturer's instructions.

AVIS: Afin d'être en mesure de réparer cet appareil, il doit être installé avec les roulettes fournis, un connecteur conforme à la norme **ANSI Z21.69** ou **CAN / CGA- 6.16** et un dispositif de déconnexion rapide conforme à la norme **ANSI Z21.41** ou **CSA- 6.9**. Il doit également être installé avec moyens de retenue pour se prémunir contre la transmission de la souche au connecteur tel que spécifié dans les instructions du fabricant de l'appareil.

For Natural Gas: Burners are equipped with orifice spud drilled with No.30 drill size.

For LP Gas: Burners are equipped with orifice spud drilled with No. 49 drill size.

INSTALLATION GUIDELINES / CONSIGNES D'INSTALLATION

GAS / GAZ

Gas installation must conform with local codes, or in the absence of local codes, with the **National Fuel Gas Code, ANSI 2223.1 /NFPA 54**, or the **Natural Gas and Propane Installation Code, CSA B749.1**

installation de gaz doit être conforme aux codes locaux , ou en l'absence de codes locaux, avec le **Code National Fuel Gas , ANSI 2223,1 / NFPA 54 , ou le gaz naturel et propane Code d'installation , CSA B749.1**

ELECTRICAL INSTALLATION / INSTALLATION ÉLECTRIQUE

This appliance, when installed, must be electrically grounded in accordance with local codes, or in the absence of local codes, with the **National Electrical Code, ANSI/NFPA 70**, or the **Canadian Electrical Code, CSA C22.2**, as applicable. For your convenience, this appliance has been wired with a NEMA 5-15 cord and plug and should be plugged in to a corresponding NEMA 5-15 receptacle. The grounding prong **SHOULD NOT BE CUT. Cutting the grounding prong will void the manufacturers warranty**

Cet appareil , lorsqu'il est installé , doit être mis à la terre conformément aux codes locaux , ou en l'absence de codes locaux, avec le **National Electrical Code , ANSI / NFPA 70 , ou au Code canadien de l'électricité , CSA C22.2** , selon le cas . Pour votre commodité, cet appareil a été câblé avec un cordon NEMA 5-15 et branchez et doit être branché à un correspondant NEMA 5-15 récipient. La mise à la terre doit pas être coupé . **Couper la broche de terre annulera la garantie du fabricant**

PRESSURE TEST / TEST DE PRESSION

The appliance and its individual shut off valve must be disconnected from the gas supply piping system during any pressure testing of that system at test pressures in excess of $1/2$ psi (**3.5** kpa).

The appliance must be isolated from the gas supply piping system by closing its individual manual shut off valve during any pressure testing of the gas supply piping system at test pressures equal to or less than $1/2$ psi (**3.5** kpa).

L'appareil et son robinet d'arrêt doit être déconnecté du système de tuyauterie d'alimentation en gaz pendant les essais de pression de ce système à des pressions de test supérieures à $1/2$ psi (**3,5** kpa) .

L'appareil doit être isolé du système de tuyauterie d'alimentation en gaz en fermant son manuel individuel robinet d'arrêt pendant tout test de pression du système de tuyauterie d'alimentation en gaz à des pressions d'essai moins de $1/2$ psi (**3,5** kpa) égale ou .

Table of Contents

Installation Tips 9
Overview Of The Unit 10
Unpacking The Unit 11
Setting Up The Rotisserie 11
Control Panel Overview 13
Gas Conversion and Adjustment Instructions 14
Spit Preparation Using Angle Spits 19
Spit Preparation Using Spits & Skewers 24
Daily Operation 29
Cleaning 30
Thermometer Guidelines 31
Temperature Chart 32
Do's and Don'ts 33
Parts Diagram 34
Electrical Diagram 35
Warranty 36

*KEEP THIS MANUAL FOR FUTURE REFERENCE
(CONSERVER CE MANUEL POUR FUTURE RÉFÉRENCE)*

Installation Tips

- a. When installing these units, it is important to comply with the most recently established rules and regulations as deemed pertinent by the local and national electrical, gas, ventilation, sanitation, and fire codes. These units are classified by Underwriters Laboratories, Inc. as Gas-Fired Food Service Equipment in accordance with American National Standards Institute ANSI Z83.11b-1991, Gas Food Service Equipment - Ranges and Unit Boilers.
- b. These gas units may not be directly connected to a gas flue or exhaust. However, the units may only be operated in conjunction with a canopy type exhaust hood.
- c. The room where the units are being installed must be ventilated in accordance to the valid codes and regulations.
- d. The units are to be installed securely and horizontally. The units may be installed on combustible floors.
- e. The minimum clearance to the rear or side walls must be 3 inches. It is also important to insure that the bottom of the units is kept clear so that proper ventilation or air exchange can occur.
- f. Normally, the units will be sent to the operator already set up for the particular type of gas available at their location. However, unless otherwise specified, the units will be set up for natural gas use. Before installing and using the units for the first time, it is important to make sure that the gas type and pressure indicated on the data plate matches the type of gas available in the location. Should this not be the case, it is imperative to change or convert the units to the needed gas type.
- g. The units must be fitted with the manual shut-off gas cock (valve) supplied with the machine. This manual valve is needed to shut off the gas to the machine during maintenance work, repairs, pressure testing and if the unit needs to be disconnected for any reason. **DO NOT REMOVE otherwise warranty will be voided.**
- h. A gas regulator is also supplied with the machine. This component is needed so that the appropriate gas pressure can be set and insure an optimum operation of the unit. **DO NOT REMOVE otherwise warranty will be voided.**
- i. When installing this unit with a gas quick disconnect, a tethering device must be used.
- j. Depending on local codes or if deemed necessary, a gas filter may also be required.
- k. Do not connect the unit to a 1" gas line. Connecting the unit to a lesser line can reduce the units effectiveness or cause improper operation.

- l. After connecting the unit, make sure that the line has been bled and that a static pressure reading of at least 7" water column pressure is obtained.
- m. The unit is equipped with a water connection to facilitate filling of the drip pan with water. Connect the 1/2 inch water valve to a flexible connection to facilitate movement of the unit for cleaning.
- n. Drain - the unit is equipped with an 1 1/2" drain. If connecting to the drain, make sure the drain it is connected to a fat trap. Adhere to all local plumbing codes.
- o. When the waste valve is not connected, we recommend the use of a bucket. At the end of the day, place the bucket at the waste valve. Open the water inlet slightly and fill the drain until the fat and grease has floated into the drain. Shut the water and bring the bucket to the cooler and let the fat rise and skim off the fat and place into the fat rendering tank. The remaining water can be discarded into the sink.

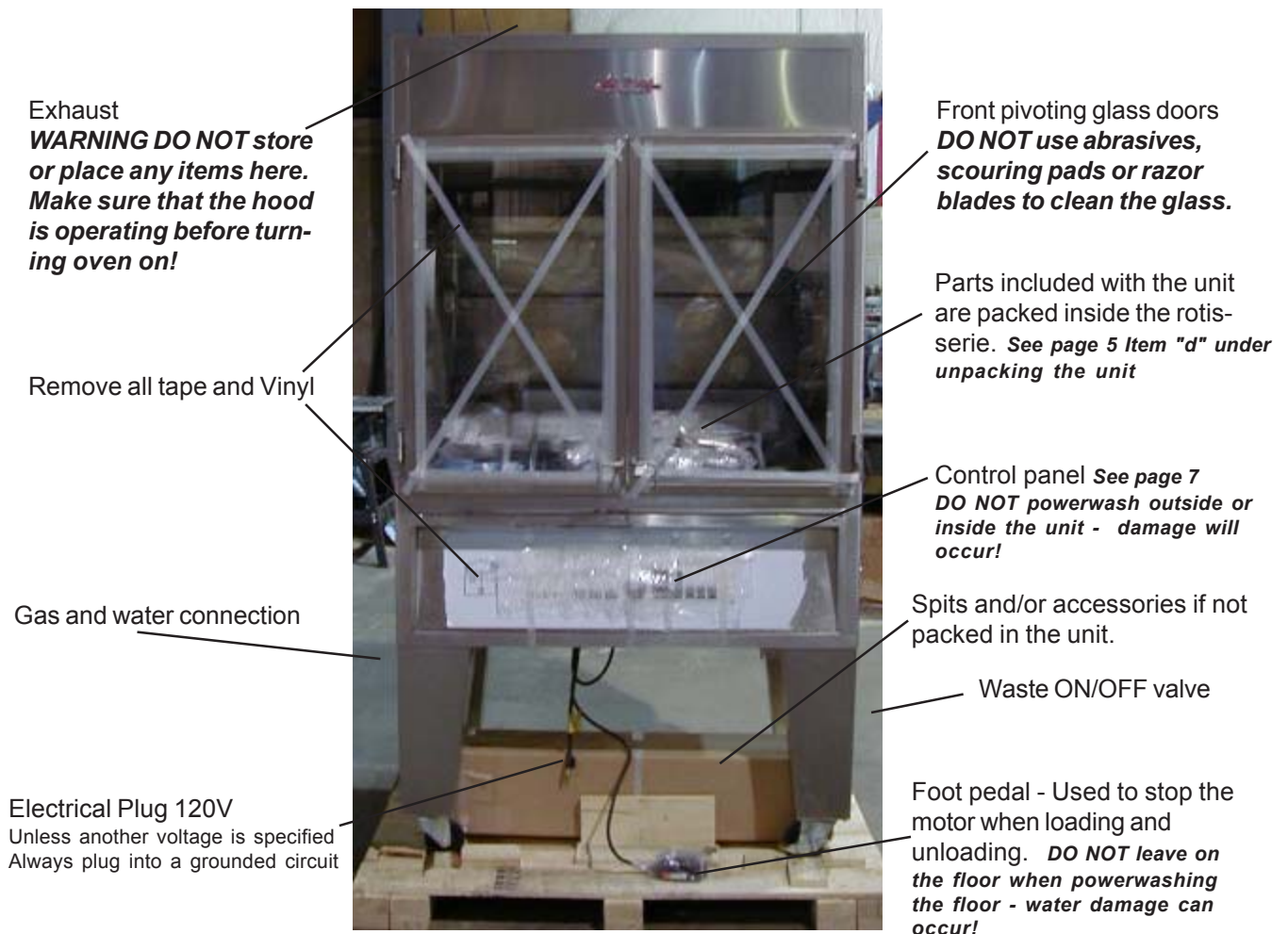

Overview of the unit before set up

Unpacking the unit:

- a. After the unit is un-crated, roll the unit and all accessories into place.
- b. Remove all vinyl paper on the stainless steel
- c. Remove all tape from glass surfaces and metal surfaces
- d. Carefully remove and inspect parts that are inside the unit. Ensure that all materials sent with the crate are inspected:

Items that are sent with the unit are:

(extra parts vary from customer to customer)

Cooking Spits (7) Spits and skewers, Angle spits or thermowave spits.

Over Flow Tubes (2)

Removable rear cleaning panel (1)

Wire Rack (1)

Ceramic Logs (4)

Ball Knobs (2)

Log Carrier (1) Installed on the rear burner

Thumbscrew Key (1) If sent with spits and skewers

Setting Up The Rotisserie

- a. Clean, rinse and sanitize the spits. If baskets and accessories are ordered, clean and sanitize as well.

- b. Place the ball knobs on the doors.

Tighten firmly.



- c. Place the removable rear panel on the rear of the unit.



1.



2.



3.

- d. Place the ceramic logs on the rear ceramic log holder. Note the placement of the left ceramic log - it must be located over the ignitor box to prevent fat from clogging the burner holes.



- e. Insert the drain overflow tubes and reinsert the wire rack.



- f. Remove the drain handle and install the handle onto the valve and tighten.



Valve in open position

Valve in closed position

- g. The rotisserie is now ready to be plumbed by a licensed gas fitter.

Gas shut off and pressure tap

Pressure Regulator



Water connection

Water outlet to drip pan



Water connection and drip pan water inlet valve.



Gas inlet, pressure regulator & main shutoff valve



Drain valve "open position"

Thermostat:

Cycles heat ON and OFF during cooking.
Product that has marinades, citrus, rubs etc.. may burn which can be remedied by turning the thermostat at a lower temperature.

Temperature Switch:

Turns heat ON / OFF Indicator is illuminated when the thermostat calls for heat.

Timer:

Displays the time of day.
Allows the unit to cook and can be used to shut the heat OFF at the end of a cook.



Motor Switch:
Turns motor ON / OFF

Light Switch:
Turns lights ON / OFF

Rear Show Burner Switch:
Turns rear burner ON / OFF
MOTOR SWITCH MUST BE ON

Top Burner Switches:
Turns cooking burners ON / OFF
We recommend one burner ON with 1 to 3 spits of product and both burners ON with 4 or more spits of product.

Control Panel Overview

Gas Conversion and Adjustment Instructions

Before converting or adjusting the machine to another type of gas, it is imperative that the manual gas cock be turned to the "off" position. The electrical power to the machines should also be turned off. When converting the gas generators for use from one type of gas use to another, the gas orifice (or injector) must be changed according to the table on page 16. In addition, the spring in the pressure regulator supplied with the unit must be changed so that it can operate at other gas pressures. Springs for the regulator can be ordered from Hickory Industries.

IMPORTANT YOU MUST WAIT 5 MINUTES BEFORE TO RE-LIGHTING UNIT
IMPORTANT VOUS DEVEZ ATTENDRE 5 MINUTES AVANT DE RE-LIGHTING UNIT

Gas Conversion and Adjustment Instructions for Show Burner (SB)

Before converting or adjusting the machine, it is imperative that the manual gas cock be turned to the "off" position. The electrical power to the machines should also be turned off. When converting from one type of gas to another, the gas orifice (or injector) and the primary air adjustment must be changed according to the table on page 16. In addition, the spring in the pressure regulator must be changed as previously explained.

Verification for use with Natural Gas

The flame setting for each gas generator and for the pipe burner can be confirmed by using the volumetric method in conjunction with the main gas meter. Each burner has an independent solenoid gas valve. Each valve is controlled by its own, independent Gaslite spark ignition module. The amount of gas flowing through the valves can not be adjusted manually; there is only an "on" or "off" position.

To carry out this verification procedure, it is necessary to obtain the heating value (BTU/ft³) of the local gas from the local gas company. **A variation in the heating value of the local gas from that on the table (pg 15) will result in a variation of the power output of the unit!**

If the measured gas volume does not correspond to the values in the following table (pg 15), the items which should be checked are:

- A. The incoming (connected) gas pressure while all burners and all other appliances in the location are operational.
- B. If the gas pressure is correct, it must be verified that the proper size gas orifices are in place (see page 16).



Solenoid Valve

Gas Flow Table (Consumption)

Gas	Heating Value in BTU/ft ³	Gas Flow
		per Burner (40,000 BTU) in ft ³ /hr
		High Flame Setting
Natural	1040	38.50
Propane	2500	16.00
Butane	2500	16.00

Volumetric Method to Verify the Flame Setting, Mathematical

WARNING! No other gas equipment can be in operation during this procedure.

ATTENTION! Aucun autre équipement de gaz peut être en service au cours de cette procédure.

Calculation of flow rate E in ft³/hour

$$Q = \frac{E}{H_i}$$

Q = Flow rate in ft³/time

E = High Flame Power setting in BTU/hr

H_i = Heating value in BTU/ft³

Thus, for natural gas:

$$Q = \frac{40,000 \text{ BTU/hr}}{1040 \text{ BTU/ft}^3} = \frac{38.50 \text{ ft}^3/\text{hr}}{1} = 0.64 \text{ ft}^3/\text{min.}$$

$$Q = 0.64 \text{ ft}^3/\text{min.}$$

Calculation of the natural gas needed in 1 hour by a 7.7G (4 burners) at full power:

$$Q = 38.50 * 4 = 154 \text{ ft}^3/\text{hr} = 2.56 \text{ ft}^3/\text{min.}$$

The time and the flow measurements should be taken at the gas (flow) meter with a chronometer (stop watch).

To run the test, open the manual gas cock valve, start up the unit according to the start-up instructions.

Allow the unit to pre-heat (burn) for 10 to 15 minutes. Verify that the flow rate is calibrated to the appropriate flow rate indicated in the table.

NOTE: This mathematical calculation was done assuming a #38 orifice size and a connected gas pressure of 5.5" with an infra-red generator. The actual flow rate will vary depending on the Heating Value of the local gas and on the set gas pressure!

**Orifice Diameters, Electrode Gap Settings, and Air Intake Settings
Type N/5.7 G**

Gas / Pressure	Orifice Size	Electronic Ignition	
inches W.C.	Ø in drill size	Electrode Gap	
Natural / 5.5"	#32	1/8" Between rods 1/8" Between rods and Burner surface	
Propane / 11"	#48	1/8" Between rods 1/8" Between rods and Burner surface	
Butane / 11"	#48	1/8" Between rods 1/8" Between rods and Burner surface	

Type N/5.7 G with Show Burner Module

Gas / Pressure	Orifice Size	Electronic Ignition	Primary Air Intake
inches W.C.	Ø in drill size		in inches
Natural / 5.5"	#53 x 3	1/8" Between rod and Pipe Burner	1/8"
Propane / 11"	#48	1/8" Between rod and Pipe Burner	1/8"
Propane / 11"	#48	1/8" Between rod and Pipe Burner	1/8"

Changing Gas Orifices

Changing the Gas Orifice - Gas Generators

The 5.7 Gas unit has two infra-red gas generators. In older models, these generators used **ceramic** radiating plates. Both burners are interchangeable with a minor burner inlet pipe position modification.

1. When looking from the very top of the rotisserie downward, you will see the following:

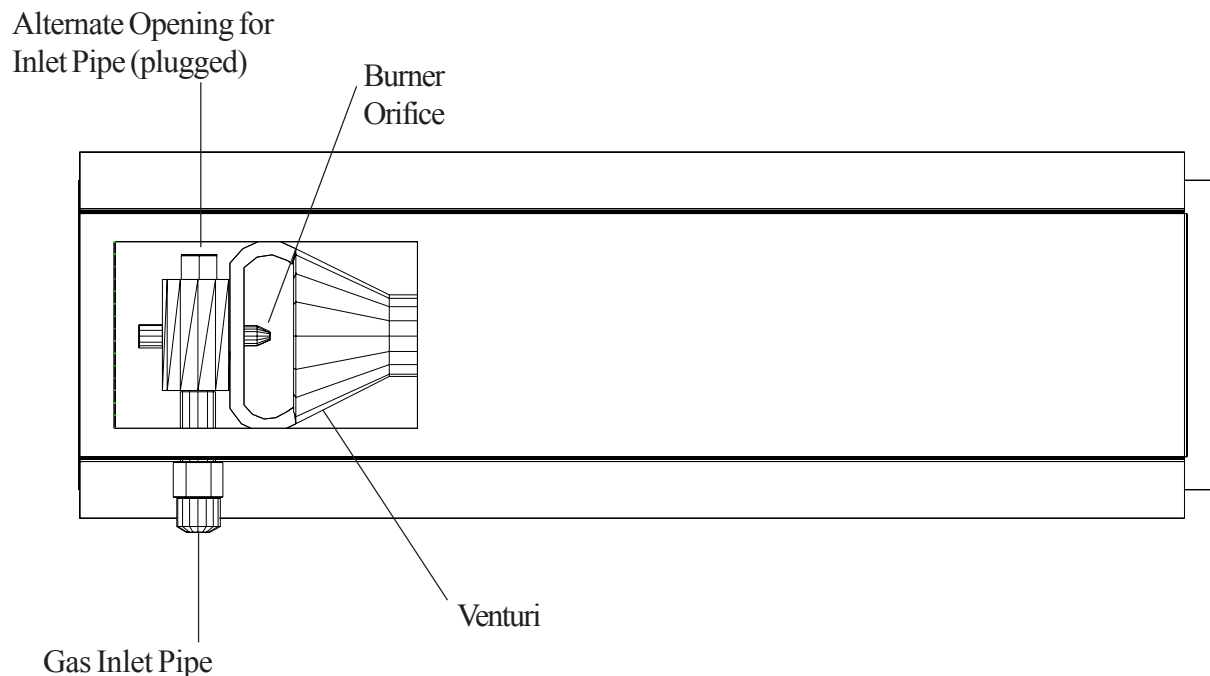

Top View Gas Generator

2. The burner orifice can be removed and replaced using a 7/16" wrench. The orifice must be sealed and tightly in place.

Changing the Gas Orifice - Pipe Burner for SB

1. Remove the left hand drip pan and loading tray.
2. Unscrew and remove the metal cover to expose the venturi.
3. The venturi tube is on the inlet side to the pipe burner.
4. On the venturi, loosen the lock nuts (7/8" wrench) and then move the nut and the air intake cap all the way to the top of the nipple.
5. With a 3/4" wrench, loosen the nipple so that it can be removed from the venturi.
6. With the nipple/orifice assembly off, separate the main orifice from the nipple with a pipe wrench or a pair of pliers.

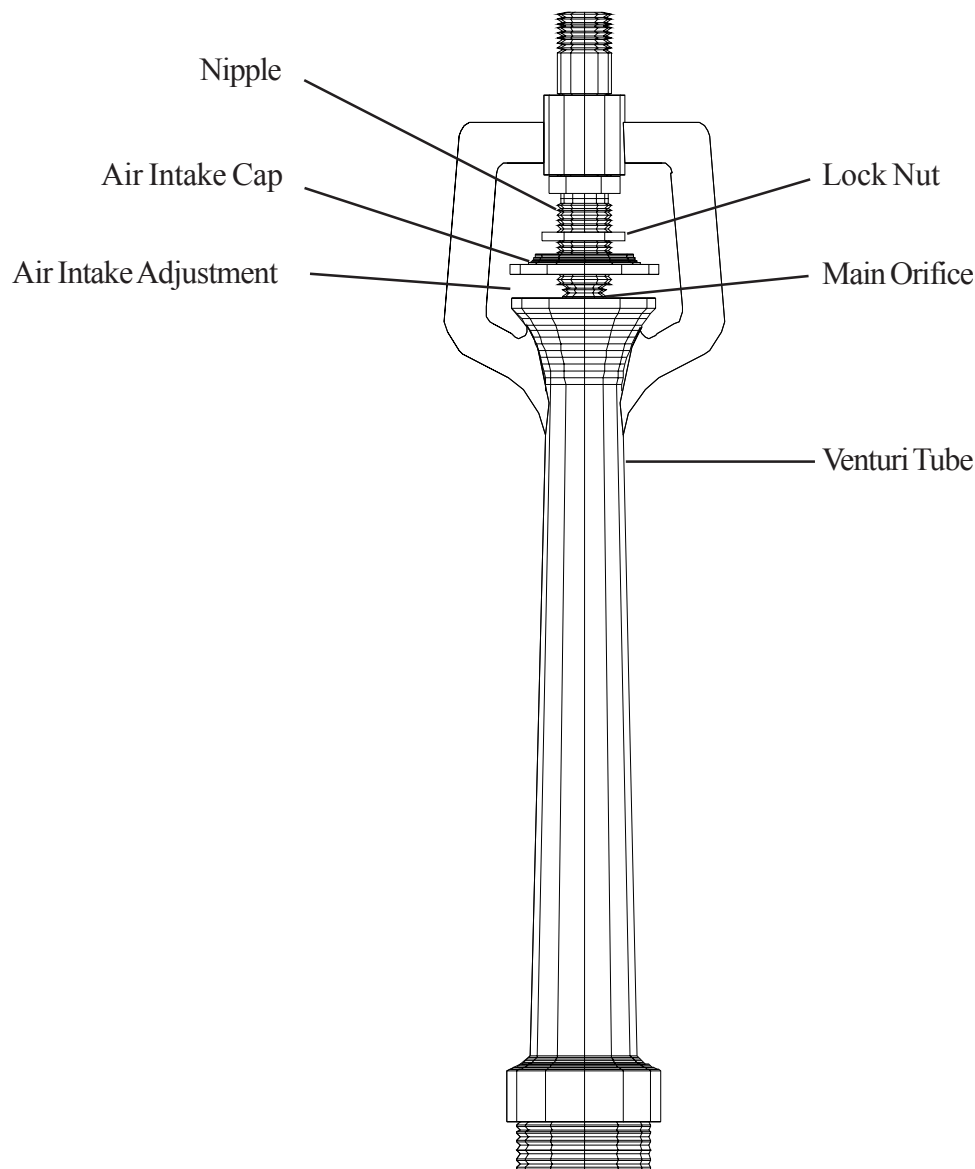

Venturi Assembly

Re-assemble all of the components with the new orifice. Make sure that the proper air intake adjustment is made for the new type of gas (according to the table on page 9). The flames should be blue in color, must be stable, and must not "lift off" the burner.

Spitting Chickens

The most important part in getting started with a rotisserie is knowing how to properly spit the product. This is quite easy, but it must be learned! As an operator, you will become an expert in spitting chickens within half an hour! There are two types of commonly used spits: the angle spit and the regular spit. The following pages describe and show how spitting is done with both these types of spits.

A. Using Angle Spits

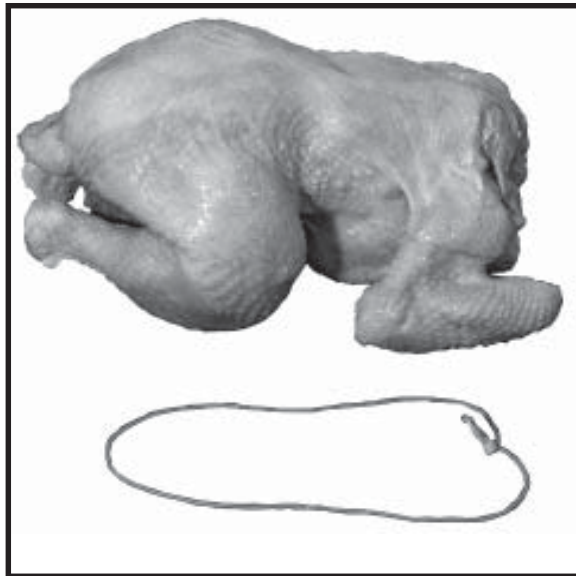

Figure 1. Chickens Ties

When using a “V” or angle spit, it is very important to tie or truss the product being cooked. This prevents the product from moving around the spit and also prevents damage by preventing the legs and wings from flopping. In this section, we will show how to properly truss a chicken. It is important to use a tie to the size of the product. In this case, we are tying a 2³/₄ lb. chicken with a 6” tie.

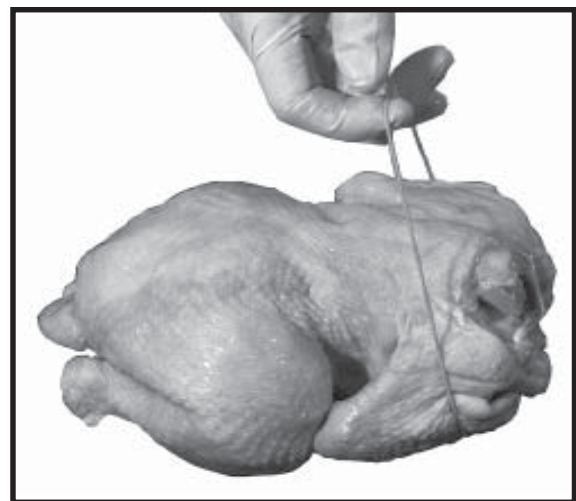

Figure 2. Trussing Wings

With the back of the chicken facing up, take the tie and wrap it around the breast, making sure to tuck the wings against the breast. Pull on the tie as pictured. You will also need to hold the chicken with your other hand.



Figure 3. Trussing Across Back

While pulling on the tie, cross the strings so that you make an “X” across the back of the chicken. With the “loop” in your hand, you will now need to tie the legs of the chicken.



Figure 4. Trussing Legs

While pulling on the tie, loop the strings over the legs of the chicken.



Figure 5. Trussed Legs

Make sure that both legs are securely held by the tie.



Figure 6. Trussed wings

Make sure that both wings are securely held by the tie against the breast of the chicken.



Figure 7. Pop-up Thermometer

The only way to tell if a chicken is done is take the internal temperature. Since it can be difficult to probe the chickens while they are in the rotisserie, we recommend the use of pop-up thermometer. These inexpensive items should be placed in the thickest part of the chicken, which is the breast. The thermostat will “pop-out” when the internal temperature reaches 185° F.



Figure 8. Chicken Ready to Spit

With the chicken trussed and the pop-up thermometer in place, the chicken is ready to be spitted with an angle spit.

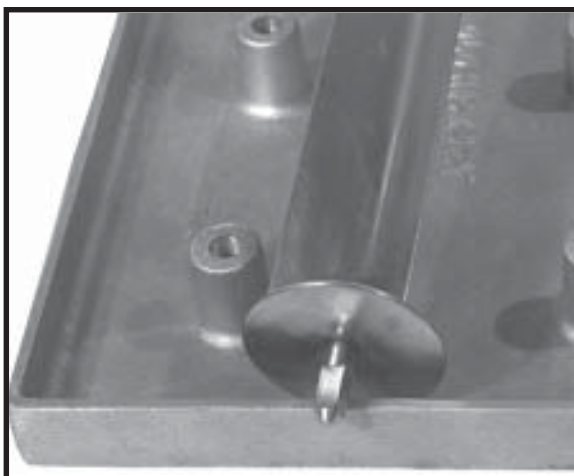

Figure 9. Spitting Accessories

In order to make the use of the angle spits fast and easy, we offer an accessory called a Spit Holder (Hickory Part 195). This aluminum plate offers six holes where the base (square-end) of the angle spit can be inserted.

Figure 10. Using the Angle Spit



Insert the bottom (square-end) of the spit into one of the holes in the Spit Holder.

Figure 11. Spitting a Chicken

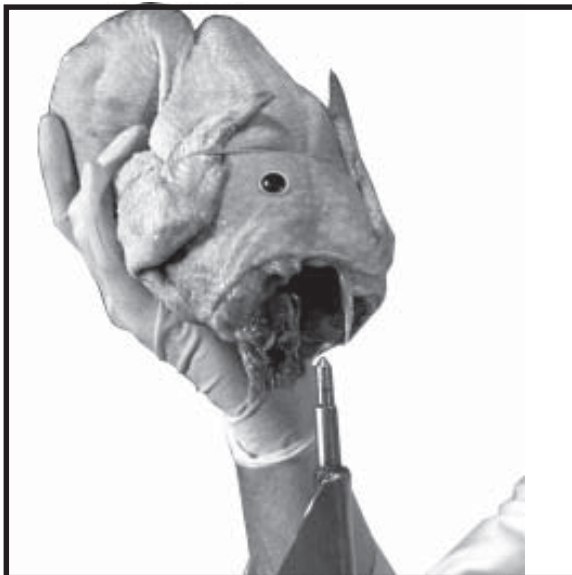

Spit the chicken through the cavity. The chicken should be inserted through the “head” (or at least where the head used to be) first.

Figure 12. Chicken Position on Spit



When spitting the chicken, make sure that the breast is sitting on the flat, exterior side of the spit. Notice on the picture how the breast is not directly on the rounded corner of the spit, but above one of the flat parts of the “V”. It is also important to note that the legs (and the tie) must sit on the same flat side of the spit. This picture shows exactly how the chicken should look when spitted.

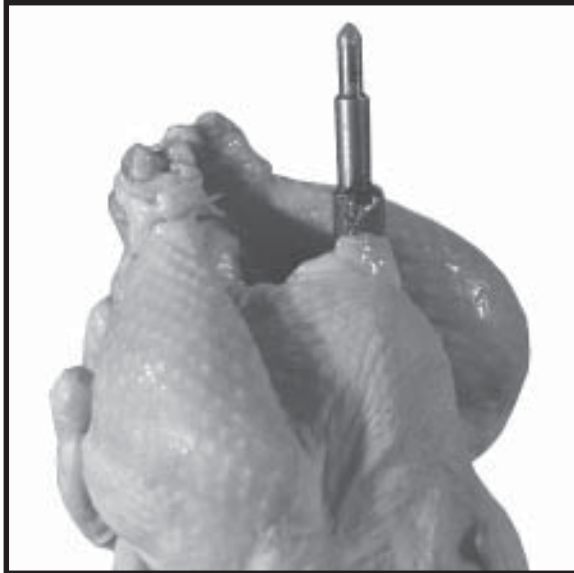

Figure 13. Incorrectly Spitted Chicken

This picture shows a chicken with the legs improperly placed. Note how the chicken seems to hang to one side. When spitted this way, the chickens will tend to “bounce” up and down causing the chicken to breakup.



Figure 14. Complete Spit

After inserting the first chicken, push it all the way to the bottom of the spit and add the next chicken. Depending on the size of the birds and on the rotisserie model, each spit will accommodate three to four $2\frac{3}{4}$ lb. chickens. Once completed, the spit is ready to be placed in the rotisserie.

B. Using Regular Spits



Figure 15. Inserting Single Bottom Skewer

Attach a *single skewer* with a *thumb screw* at least 1/2" from the square end of the spit. The skewer must be on the round section of the spit.

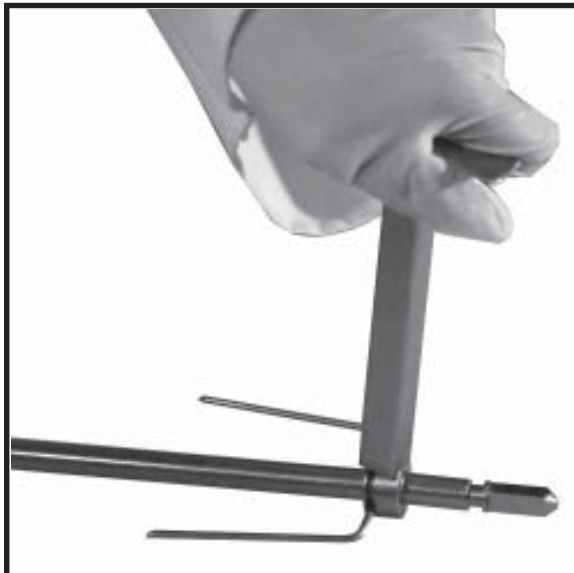

Figure 16. Fastening Bottom Skewer

Use the "T" shaped tool supplied with the unit to tighten the thumb screw. This will prevent the bottom skewer from sliding off the screw.

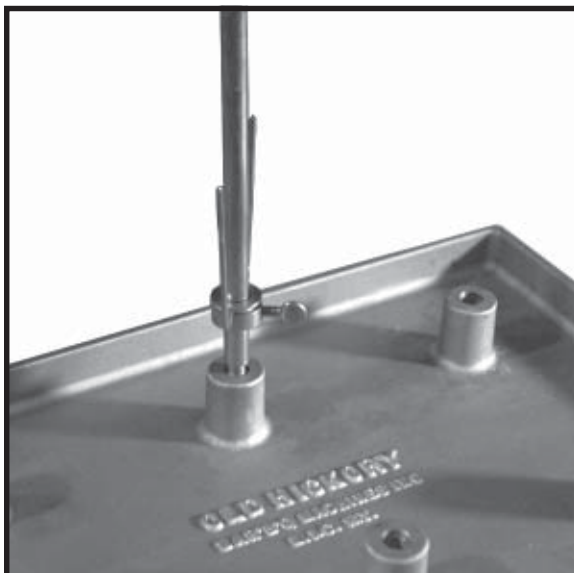
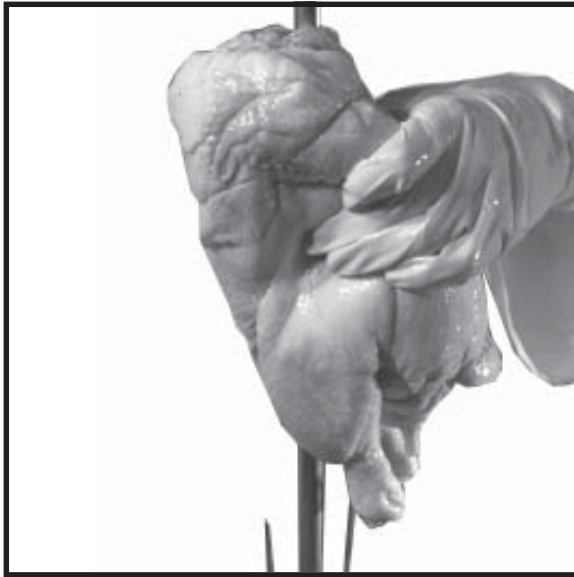

Figure 17. Using the Spit Holder

Even though the chickens can be spitted on a work table, the use of the Spit Holder (Hickory Part 195) will make the spitting process much easier.

Figure 18. Inserting Chicken



Take the chicken, with the drumsticks in the direction of the attached *skewer*, and slide the *spit* through the cavity of the chicken.

Figure 19. Tucking the Legs



The legs must be tucked between the skewer prongs and the center spit. Note that the bottom of the drumstick is what is being locked in place.

Figure 20. Pressing Chicken Towards Skewer



When viewed from the breast side of the chicken, the bottom of the drumstick is being pushed back while the meaty part of the leg is “puffed up” for better presentation. Note that the skewer is not going straight through the drumstick!

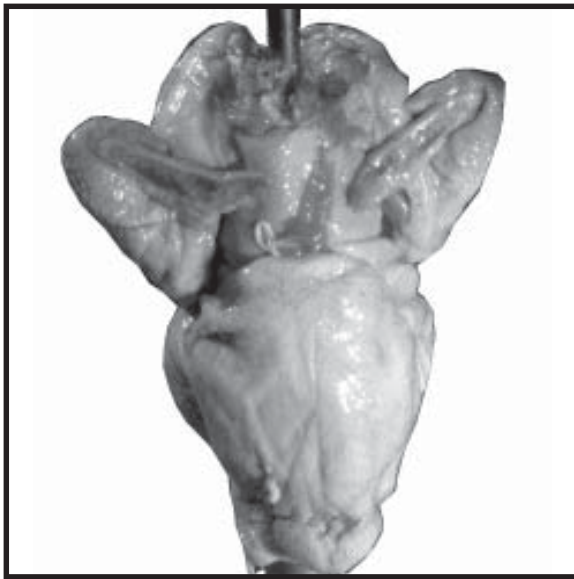

Figure 21. Locking Wings

The wings must be locked or tucked in place. **When using the models N/5.5 and N/10.10, the locking method (pictured here) is only recommended with birds up to 2³/₄ lbs!** With larger birds, the wings must be tucked under the breast, with elastic ties or “wing tuckers”. If the wings are locked on large birds, the wings on the adjacent spits will rub or catch, preventing the spits from rotating freely. This will cause the wings to break off or the gear mechanism to jam.

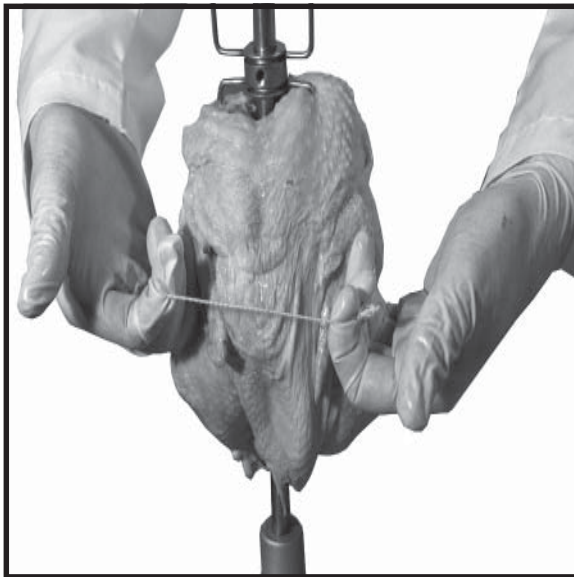

Figure 22. Tucking Wings

With larger birds, the wings must be tucked under the breast, with elastic ties or “wing tuckers”.

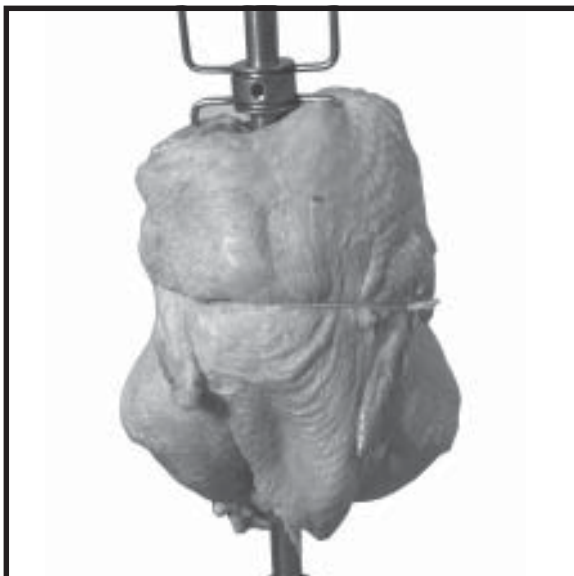

Figure 23. Tucked Wings

Notice how the wings are tucked against the breast. By “tucking” instead of “locking” the wings, the working or rotating diameter of the chicken has been reduced.

Figure 24. Inserting Double Skewers



With the first chicken in place, insert a *double skewer* down the length of the *spit* into the shoulders of the first chicken. **No *thumb screw* is required for the *double skewers*!**

WARNING! When driving the double skewer into the chicken, do not exert pressure from the end of the prongs! These are sharp and will pierce a finger or hand if not careful. Only apply pressure at the bottom of the "U" shaped half of the skewer!

Figure 25. Double Skewer in Place



With the double skewer in place, insert the next chicken down the length of the *spit* and position the chicken as previously described.

Figure 26. Loaded Spit

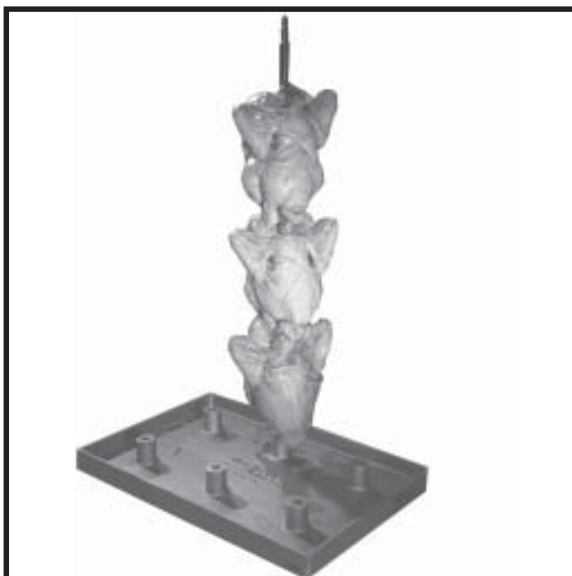

When the loading of the chickens is complete, the end of the spit must be locked in place with another single skewer.

Figure 13. Completing the Load

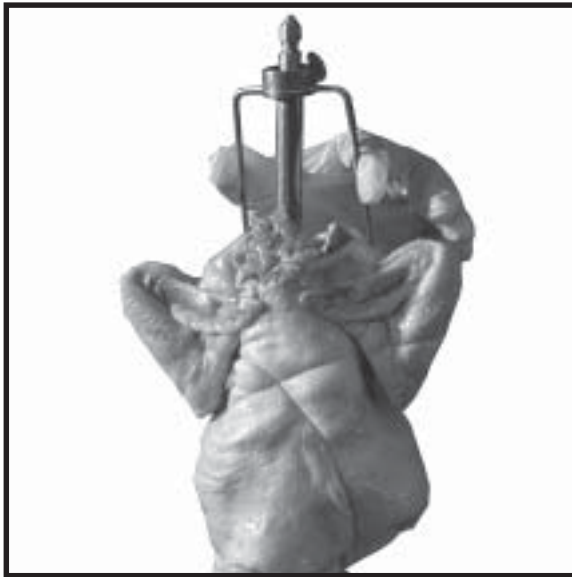

Slide a *single skewer with a thumb screw* into place from the top,

Figure 14. Tightening Final Skewer



Compress the chickens by exerting pressure on this last skewer, and tighten the thumb screw securely.

Figure 15. Securing the Load

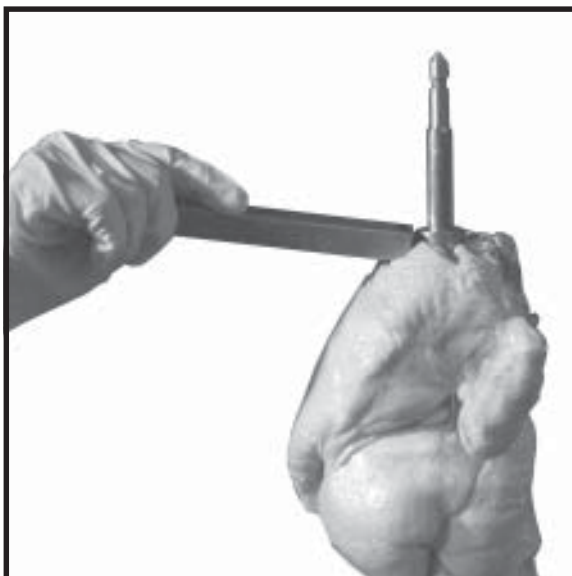

Tighten the *thumb screws* with Hickory's *thumbscrew tightening tool*. This will prevent the chickens from coming loose.

Cooking Preparations

Morning Preparation:

1. Cover the center shaft with aluminum foil.
2. Shut the drain valve and add water into drip pan (approximately one inch of water should be sufficient. If the unit will be in operation all day, you will need to add more water accordingly.).
3. **Be sure to spray the non-cooking components of the oven with Kote™. (Spray the interior walls; drums and the rear wall with USDA and FDA approved KOTE™.**
4. Turn on the motor and rear burner switch to preheat the unit. Using the rear show burner, will prelate the unit to approximately 275 degrees F.

Cooking Preparations:

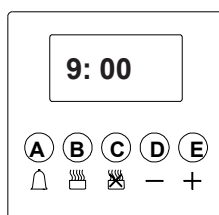

1. Be sure that the rotisserie has been preheated for approximately 20 minutes.
2. Using the foot pedal to stop the rotation of the drums, open the glass doors and place the spitted product in the rotisserie. **The pointy end of the spit goes to the left and the square end of the spit goes towards the right.**

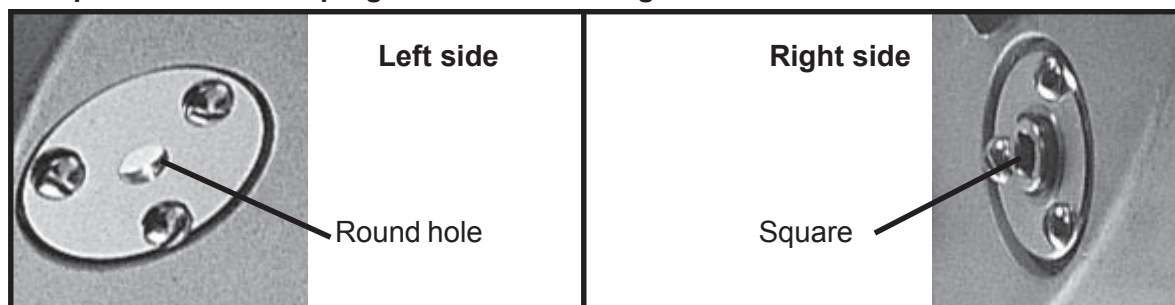

3. **REMINDER – When cooking 1 – 4 spits, use only one of the upper burners this will save energy and prevent the product from burning. When using 5 or more spits, use both upper burners for a quicker cooking time. Using only one burner with a full load of product will result in extended cooking times.**
4. Close the glass doors.
5. Be sure that the timer is set to cook. By pressing both the cook pot („B“) and cook pot off („C“) buttons simultaneously you will place the unit into the manual-cooking mode. The cook pot symbol on the timer will illuminate.
6. Turn your temperature switch on and verify the thermostat setting. Turn on the appropriate top burner switches – see item 3. Verify that the top burner(s) ignite and stay lit. **If one of the upper burners shut off, turn the temperature switch off, wait 5 seconds and then on again. This action will result in resetting the safety feature and will restart the ignition process. This procedure may need to be repeated several times especially after periods when the unit has been sitting idle for an hour or more.**
7. With the upper burners lit, press the bell/chime button („A“) and then press the + button („E“) to set the desired cooking time in hours and minutes.

8. After the programmed time has elapsed, the timer will beep, but the cooking process will continue. Always check the product's internal temperature and ensure that they are at least 180°F. If the product needs additional time to cook, you can do so by pressing the cook pot symbol („B“) and then pressing the + button (E“).
9. If product is fully cooked, shut off the temperature switch, remove the product from the oven and package accordingly. Take care not to allow the product temperatures to fall below critical temperatures.
10. To start a new load, follow step #1 through #7. **REMINDER: If possible, wipe the glass down with approved glass cleaner between cooking loads. This will facilitate end of day cleaning.**

Cleaning:

1. Shut off all burners and lights.
2. Let the oven cool down.
3. Remove the aluminum foil from the center shaft.
4. Place a bucket under the drain valve and drain the contents of the drip pan. Close the valve and refill the drip pan with hot soapy water.
5. Wipe the oven surfaces with a rag using the soapy solution; the Kote coating and the fat that has adhered to the Kote will remove very easily. If the unit was not sprayed with Kote, appropriate degreasers / cleaner will be required.
6. When finished cleaning the oven, drain the soapy solution from the drip pan and wipe the drip pan clean.
7. Wipe the glass with a glass cleaning solution. **DO NOT USE RAZOR BLADES, SCOURING PADS OR ANYTHING ABRASIVE TO CLEAN THE GLASS.** You can use an oven cleaner for stubborn spots.
8. Place the spits and skewers in a hot soapy solution. Soak for 15 - 20 minutes – this will loosen the baked on residue. Brush the baskets clean with a scrubbing brush. Follow guidelines for rinsing and sanitizing.
9. You can fill the drip pan with water in advance for tomorrow's cooking cycle.
- 10. Recommendation** – It would be a good time to place foil on the center shaft and to spray the oven down with KOTE™ for tomorrow's cooking cycle.

Thermometer Guidelines

When checking product temperature, ensure that you have a calibrated thermometer. A good thermometer should be 1/8" thick and about 6 inches long. The thermometer should not have a dimple. If it does, this is where the thermometer actually measures temperature. This dimple must be placed in the thigh area.



The thermometer should have an easily readable scale. It also should be calibrated using manufacturers recommendation.

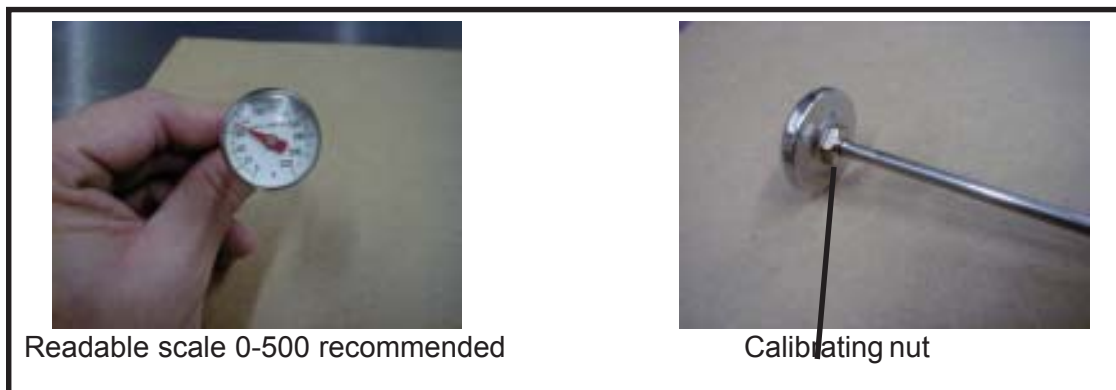

When checking for product temperature, insert your thermometer into the meatiest part of the product. When testing chickens, the thermometer should be inserted into the leg and thigh area and it should read 180 to 185 degrees F.



Temperature Chart

Product	Internal Temperature
Poultry	185F
Beef	135-140F Rare 150F Medium 160F Well
Lamb	140F Rare 150F Medium 160F Well
Pork	160F Medium 170F Well

Do's and Don'ts

Do's	Don'ts
<p>Do read the manual before operating this unit.</p>	<p>Do Not use a powerwasher to clean the unit</p>
<p>Do clean the rotisserie every day.</p>	<p>Do Not use abrasives or razors on the glass</p>
<p>Do wipe the the glass between loading and unloading product with a glass cleaner to minimize grease adhesion to the glass.</p>	<p>Do Not spray anything into the gas burners</p>
<p>Do let the oven cool down before cleaning.</p>	<p>Do Not spray anything towards the ignitors</p>
<p>Do shut the lamps off when cooling the oven down.</p>	<p>Do Not spray anything towards the lamps when they are hot - glass breakage will occur.</p>
<p>Do stop the motor operation using the foot pedal when loading and unloading.</p>	<p>Do Not spray water on the controls.</p>
	<p>Do Not leave the oven on all night.</p>

1.18 Exploded diagram

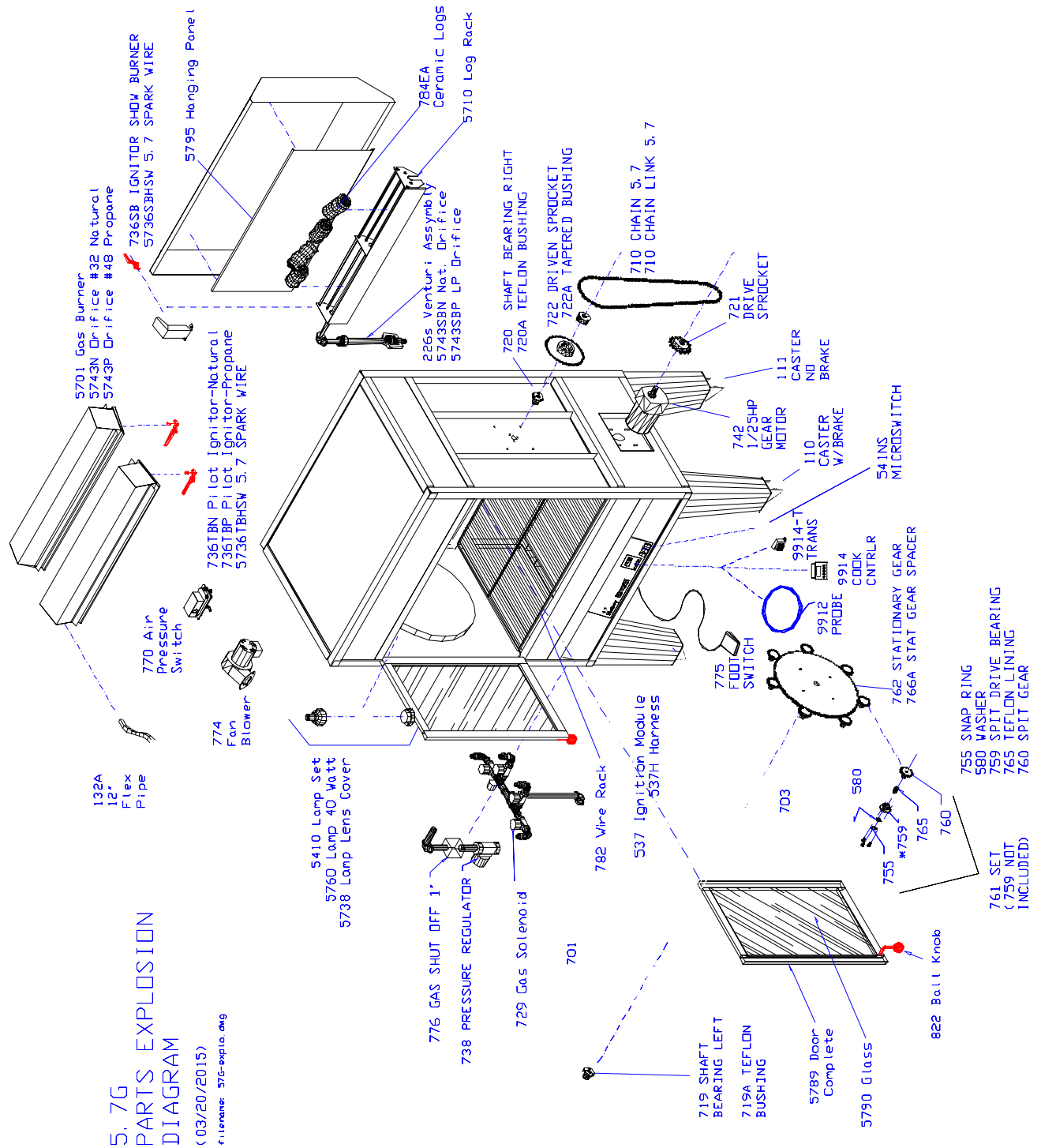

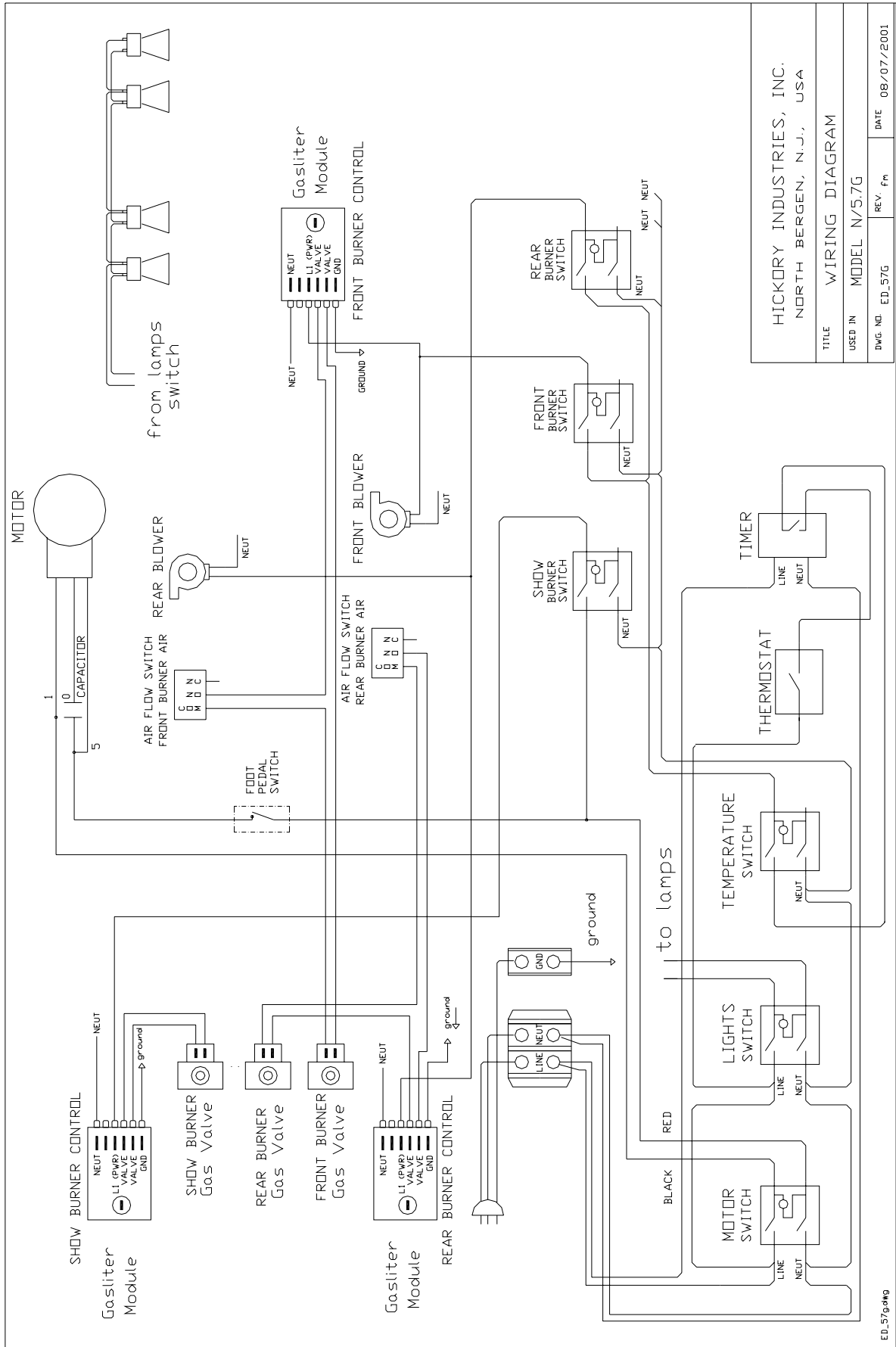

WARRANTY

HICKORY INDUSTRIES, INC., WILL WARRANTY ALL ROTISSERIES FOR ONE YEAR FROM THE DATE OF ORIGINAL INVOICE. WARRANTY INCLUDES ALL PARTS EXCEPT BULBS AND GLASS. WARRANTY CONDITION IS THAT ALL WARRANTY DOCUMENTS MUST BE SIGNED AND MUST BE RETURNED TO HICKORY BY THE USER AFTER RECEIPT OF THE ROTISSERIE. HICKORY RESERVES THE RIGHT TO REVIEW ALL WARRANTY CLAIMS SENT BY ITS AUTHORIZED REPRESENTATIVE. IF NEGLIGENCE OR ABUSE IS FOUND, THE CLAIM WILL BE DISALLOWED.

FOR SERVICE, CONTACT YOUR DISTRIBUTOR OR CALL 1-800-732-9153