



EQUIPMENT
• GATEWAY •

AIROPOWER

The Mini Frame Machine

2022

EASY AND QUICK OPERATION

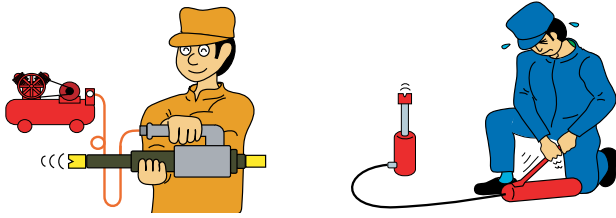

Connect the air supply and pull the lever. Very easy and quick to operate.

NO OIL LEAKS

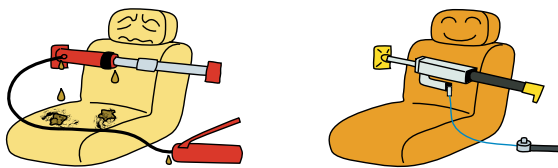

No problems with oil leaking from a cylinder or a coupling as with a hydraulic power kit. No stains on car's interior.

REMOTE CONTROL FOR SAFETY

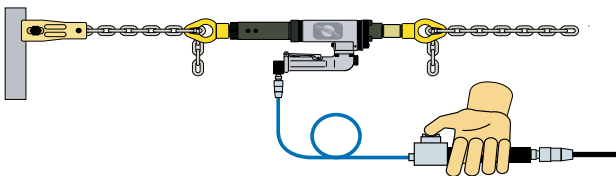

Equipped with a remote control for safety or for operation by foot. You can work from a distance of 6ft 6 in.

Standard Kit



HIGH POWER! CAPACITY - 5.25 TONS

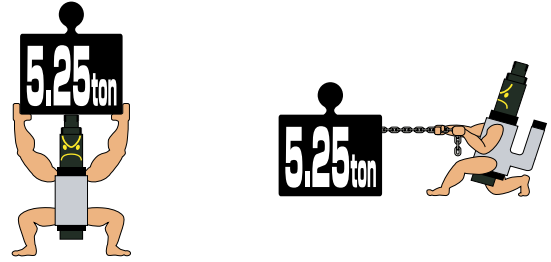

5.25 tons (operating air pressure 8 bar or 116 psi) pushing and pulling capacity.

ONE BODY FOR PUSH AND PULL

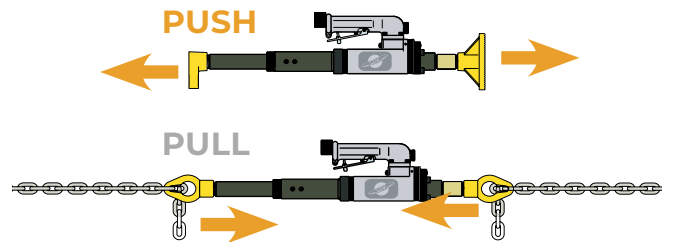

You only need one tool for pushing and pulling. Simply reverse the valve. Separate rams are not required like in conventional power kits.

PRESS/SPREAD IN NARROW SPACES

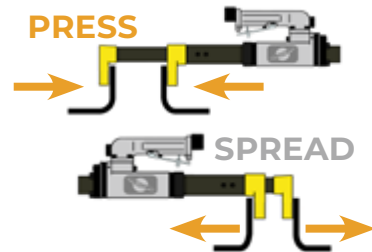

You can press and spread even in narrow spaces.

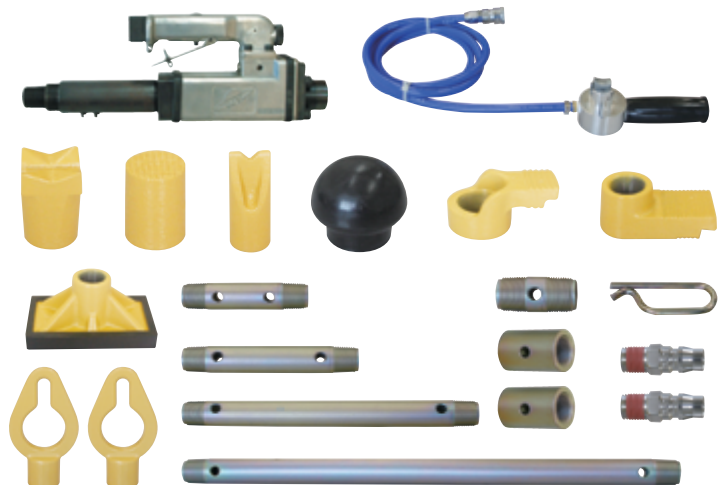

STANDARD KIT (EP-01AE) + 9PCS ACCESSORY KIT (EP-9AK)



PRACTICAL REPAIRS

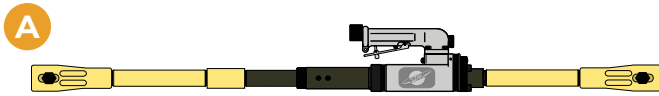

You can clamp the panel without damaging the panel edge.

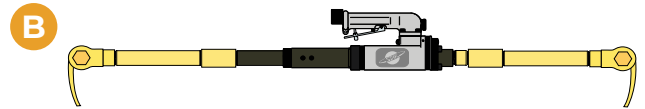

Adjustable body spoon is useful for pouched panels.

STANDARD KIT (EP-01AE) + 19PCS ACCESSORY KIT (EP-ECO19)



PRACTICAL REPAIRS

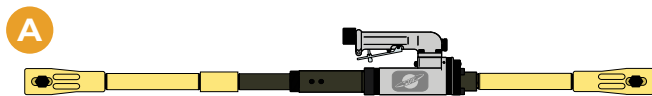

You can clamp the panel without damaging the panel edge.

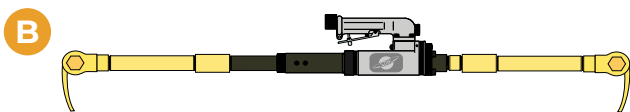

Adjustable body spoon is useful for pouched panels.

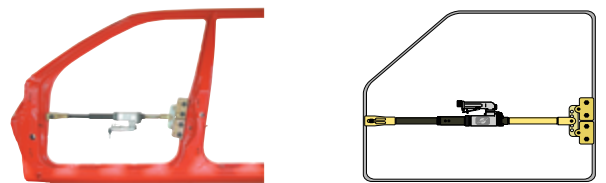
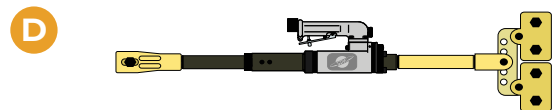

Using two wide clamps on one side allows you to carry out intensive pulling or pushing.

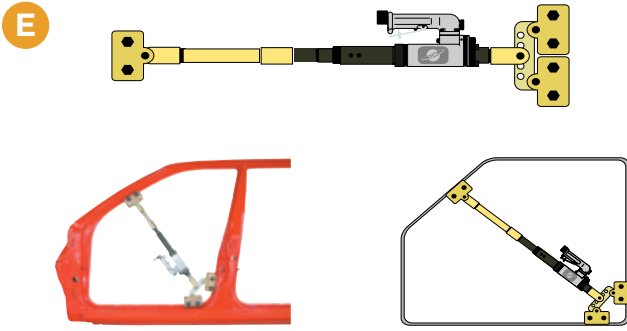

Set clamps at an angle to pull the corner of a door frame.

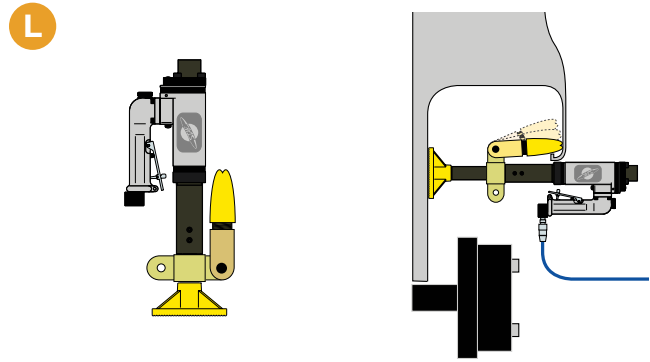

A wheel arch can be pushed out easily.

STANDARD KIT (EP-01AE) + 33PCS ACCESSORY KIT (EP-33AK)



PRACTICAL REPAIRS

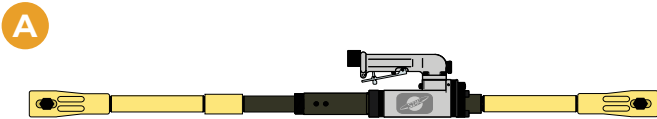

You can clamp the panel without damaging the panel edge.

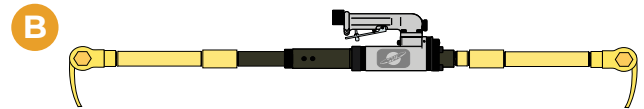

Adjustable body spoon is useful for pouched panels.

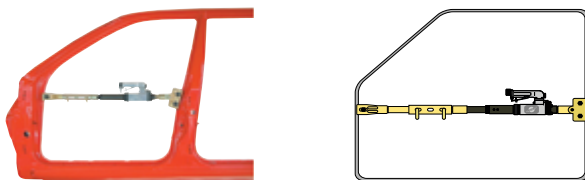
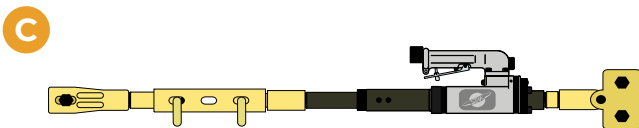

Different sized clamps enables you to control damaged area.

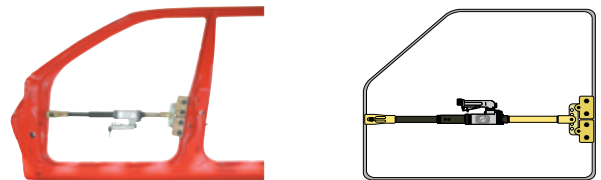
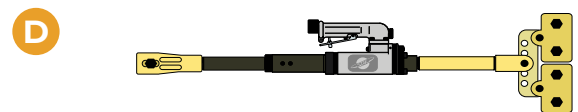

Using two wide clamps on one side allows you to carry out intensive pulling or pushing.

E

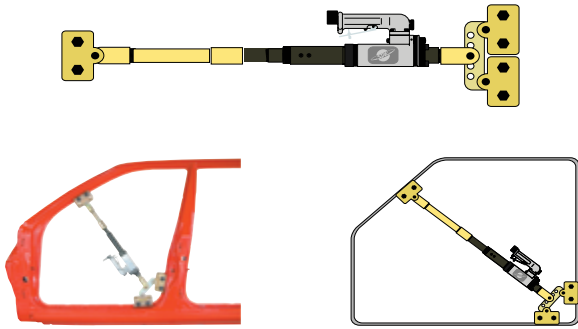

Set clamps at an angle to pull the corner of a door frame.

F

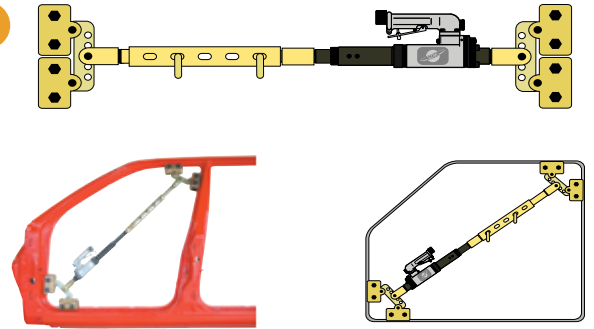

Easy to use clamps at any angle.

G

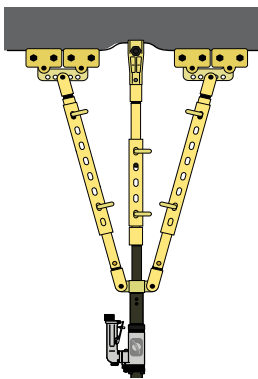

Very useful to pull a sill panel as you can spread the load onto the panel and pull only the desired part.

H

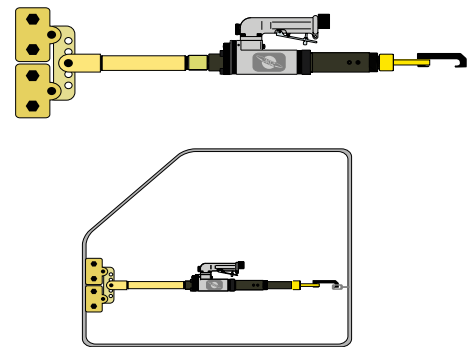

Use in conjunction with Miracle bits MB-2 to pull an edge where you cannot use clamps.

I

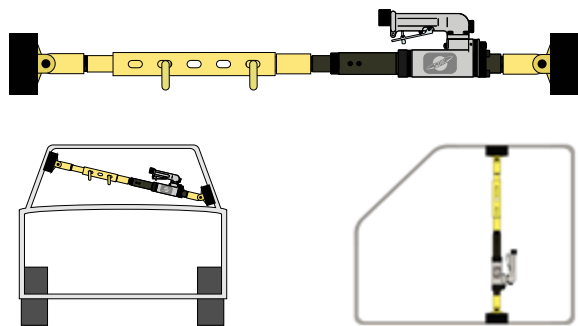

Grooved feet prevents damage to the panel edge.

STANDARD KIT (EP-01AE) + 53PCS ACCESSORY KIT (EP-53AK)

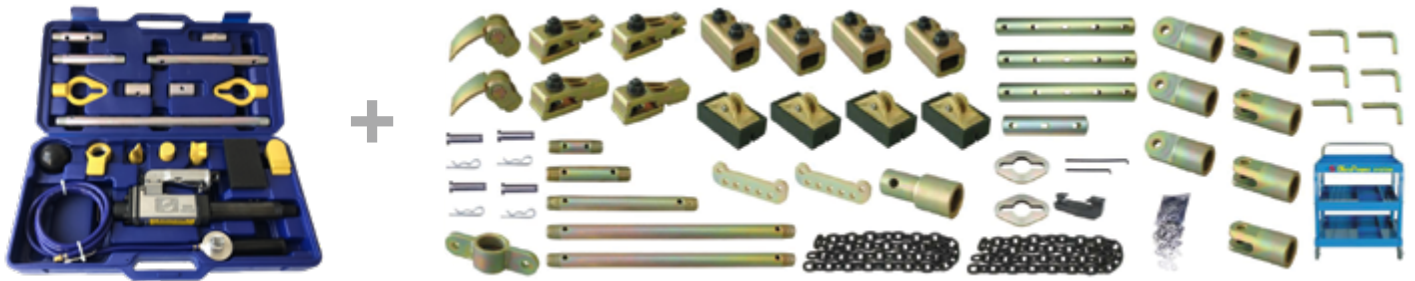

PRACTICAL REPAIRS

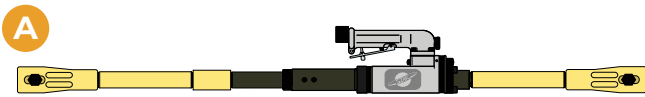

You can clamp the panel without damaging the panel edge.

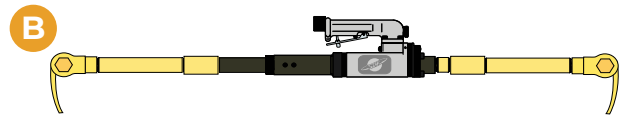

Adjustable body spoon is useful for pouched panels.

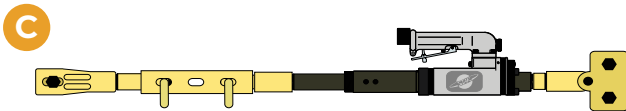

Different sized clamps enables you to control damaged area.

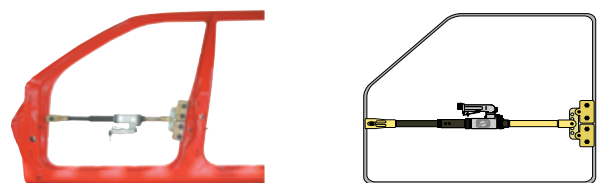
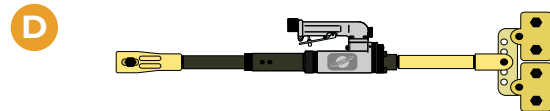

Using two wide clamps on one side allows you to carry out intensive pulling or pushing.

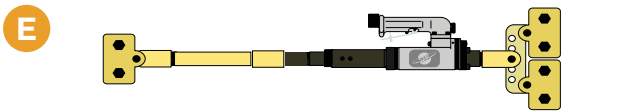

Set clamps at an angle to pull the corner of a door frame.

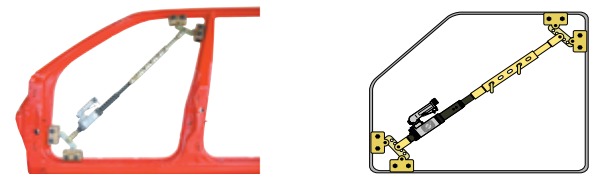
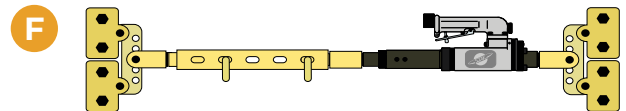

Easy to use clamps at any angle.

G

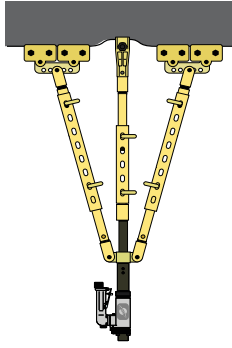

Very useful to pull a sill panel as you can spread the load onto the panel and pull only the desired part.

H

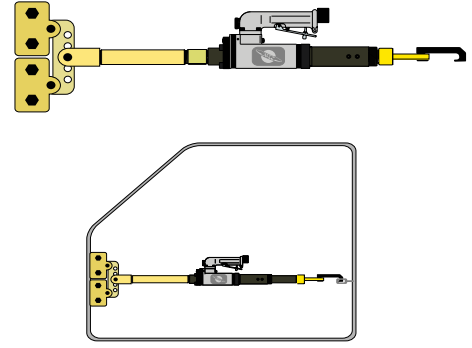

Use in conjunction with Miracle bits MB-2 to pull an edge where you cannot use clamps.

I

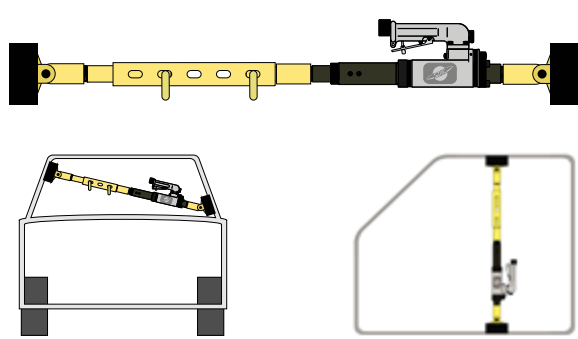

Grooved feet prevents damage to the panel edge.

J

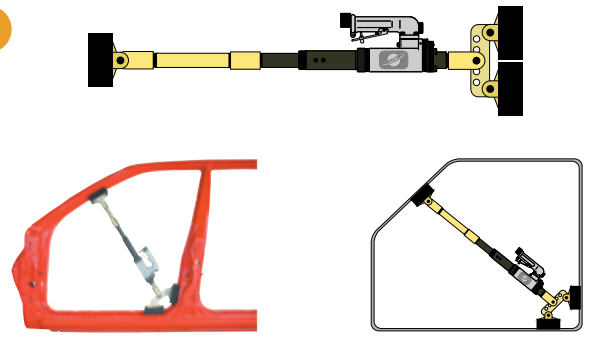

You can also use grooved feet in the corners.

K

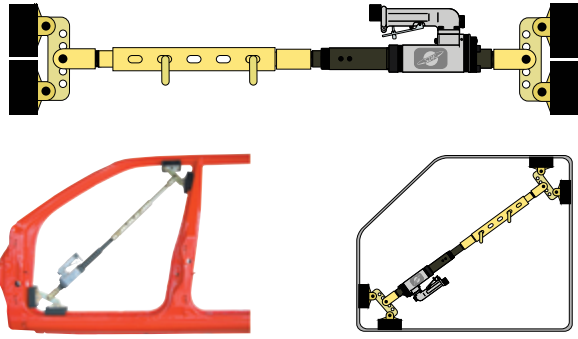

Universal connection for any desired angles.

L

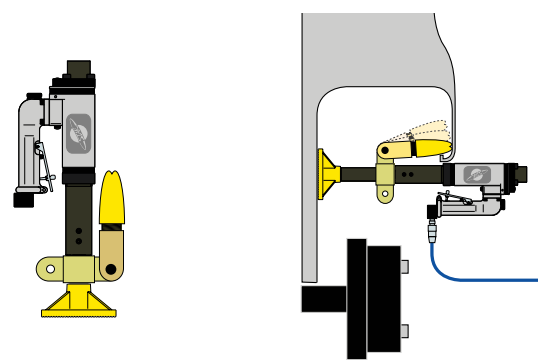

A wheel arch can be pushed out easily.

M

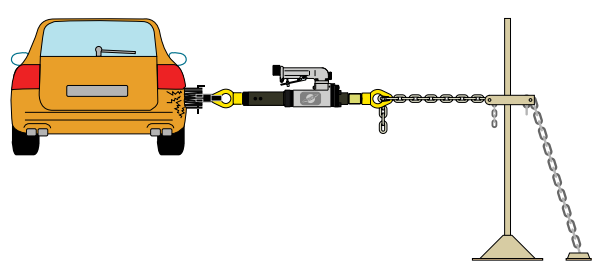
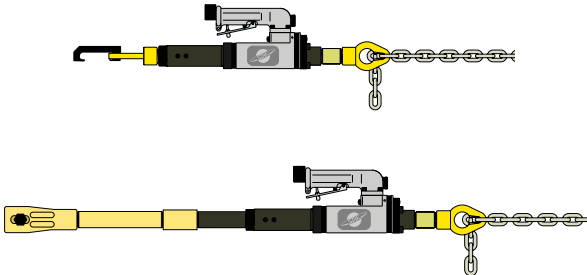

Using a mini tower allows for more useful applications. Very simple, but effective



Gateway To Collision Repair Tools & Equipment

1-866-588-7599
www.equipmentgateway.com
sales@equipmentgateway.com



Learn More