



Read all instructions before assembly and use.  
**KEEP INSTRUCTIONS FOR FUTURE USE.**

**⚠ ADULT ASSEMBLY REQUIRED**  
Due to the presence of small parts during assembly, keep out of reach of children until assembly is complete.

## 4 in 1 Crib



**THIS PRODUCT IS NOT INTENDED FOR INSTITUTIONAL OR COMMERCIAL USE.**



**Consumer Care:**  
**www.DeltaChildren.com**  
Delta Children's Products  
114 West 26th Street  
New York, NY 10001  
Tele.212-645-9033

Style #: \_\_\_\_\_  
Lot: \_\_\_\_\_  
Date: \_\_\_\_\_



When contacting Delta Consumer Care please reference the above information. Before contacting Delta Consumer Care please ensure that the information above matches the information found on the label on the Crib End bottom rail, please reference the information found on the product when contacting Delta Consumer Care.

To register your product for important safety alerts and updates to your product please visit [www.DeltaChildren.com](http://www.DeltaChildren.com) and click on Product Registration.

## CAUTION:

ANY MATTRESS USED IN THIS CRIB SHALL BE AT LEAST 27 1/4 BY 51 5/8 IN. WITH A THICKNESS NOT EXCEEDING 6 IN.

## WARNING:

- \*Infants can suffocate on soft bedding. Never add a pillow or comforter. Never place additional padding under an infant.
- \*Failure to follow these warnings and the assembly instructions could result in serious injury or death. DO NOT use this crib if you cannot exactly follow the accompanying instructions.
- \*To reduce the risk of SIDS, pediatricians recommend healthy infants be placed on their backs to sleep, unless otherwise advised by your physician.
- \***Strangulation Hazard:** STRINGS CAN CAUSE STRANGULATION! Do not place items with a string around a child's neck, such as hood strings or pacifier cords. Do not suspend strings over a crib or attach strings to toys.
- \***Strangulation Hazard:** To help prevent strangulation tighten all fasteners. A child can trap parts of the body or clothing on loose fasteners.
- \***Strangulation Hazard:** Do not place crib near window or patio door where cords from blinds or drapes may strangle a child.
- \***Fall Hazard:** When child is able to pull to a standing position, set mattress to lowest position and remove bumper pads, large toys and other objects that could serve as steps for climbing out. This crib has an adjustable mattress support. For the convenience of the parent when the baby is very small, the mattress support may be used in the highest position. Important: with the mattress support and mattress in the highest position, be absolutely sure that the top of the front crib side is at least 3 inches higher than the top surface of the mattress. If it is not, lower the mattress support and the mattress to the next highest position.
- \***Fall Hazard:** Stop using crib when child begins to climb out or reaches a height of 35in. (89cm), whichever occurs first. The child should be placed in a youth or regular bed.
- \*Check this product for damaged hardware, loose joints, loose bolts or other fasteners, missing parts, or sharp edges before and after assembly and frequently during use. Securely tighten loose bolts and other fasteners. **Do not use crib** if any parts are missing, damaged or broken. Contact Delta Children's Products for replacement parts and instructional literature if needed. Do not substitute parts.
- \*Follow warnings on **all** products in a crib.
- \*If refinishing, use a non-toxic finish specified for children's products.
- \***Never** use plastic shipping bags or other plastic film as mattress covers because they can cause suffocation.
- \*Infants can suffocate in gaps between crib sides and a mattress that is too small.
- \*Ensure a safe environment for the child by checking regularly, before placing the child in the crib, that every component is properly and securely in place.
- \*To avoid head injury, do not allow any child to play underneath the crib.
- \***Never** add an accessory such as a bassinet or changing table that extends over the sleeping area.
- \***In Canada Only** - Use a crib mattress that is no thicker than 15 cm and is of such a size that, when it is pushed firmly against any side of the crib, it does not leave a gap of more than 3 cm between the mattress and any part of the sides of the crib. Do not use this crib for a child who can climb out of it or who is taller than 90 cm.

# TODDLER BED

## **⚠️WARNING**

### **INFANTS HAVE DIED IN TODDLER BEDS FROM ENTRAPMENT.**

Openings in and between toddler bed parts can entrap head and neck of a small child.  
NEVER use toddler bed with children younger than 15 months.  
ALWAYS follow assembly instructions.  
The maximum user weight is 50lbs (22.7kg)

## **⚠️WARNING**

### **STRANGULATION HAZARD**

NEVER place bed near windows where cords from blinds or drapes may strangle a child.  
NEVER suspend strings over a bed.  
NEVER place items with a string, cord, or ribbon, such as hood strings or pacifier cords, around a child's neck. These items may catch on bed parts.

## **⚠️CAUTION**

### **ENTRAPMENT HAZARD**

To avoid dangerous gaps, any mattress used in this bed shall be a full-size crib mattress at least 51 5/8 in (1310mm) in length, 27 1/4 in (690mm) in width and a max thickness of 6 in (150 mm).

### **NOTES ON ASSEMBLY:**

- During the assembly process whenever using screws or bolts, check each by placing the screw/bolt on the diagram of the item which is drawn actual size and design. Be sure to use the proper size and shape specified in the instructions.
- To assemble this unit you may be required to place the unit on it's side and face. It is strongly recommended that assembly is done on a soft, non-abrasive surface to avoid damaging the finish.

### **NOTES ON USE:**

Keep children and others safe by following these simple rules:

- **Do not** allow any child to play on furniture
- **Do not** allow climbing on any piece of furniture.
- **Do not** allow hanging from any piece of furniture.
- Always monitor your child's activity when in the nursery.

### **NOTES ON CARE AND MAINTENANCE:**

- **Do not** scratch or chip the finish.
- Inspect the product periodically, contact Delta Children's Products for replacement parts or questions.
- **Do not** store the product or any parts in extreme temperatures and conditions such as a hot attic or a damp, cold basement. These extremes can cause a loss of structural integrity.
- To preserve the luster of the high quality finish on your product, it is recommended to place a doily or felt pad under any items you place on the finish.
- Clean with a damp cloth, then a dry cloth to preserve the original luster and beauty of this fine finish.
- Do not** use abrasive chemicals.
- Do not** spray cleaners directly onto furniture.
- Lift slightly when moving on carpeting to prevent leg breakage.
- Use of a vaporizer near furniture will cause wood to swell and finish to peel.

# PARTS: MAKE SURE THAT ALL PRE-ASSEMBLED PARTS ARE TIGHT.

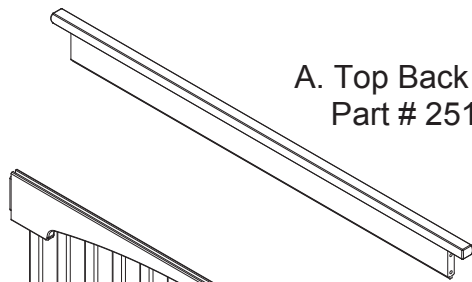

A. Top Back Rail x 1  
Part # 25183

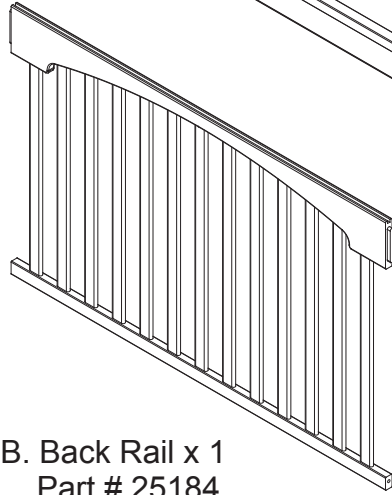

B. Back Rail x 1  
Part # 25184

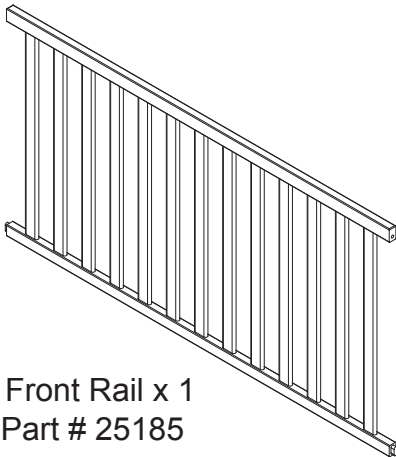

C. Front Rail x 1  
Part # 25185

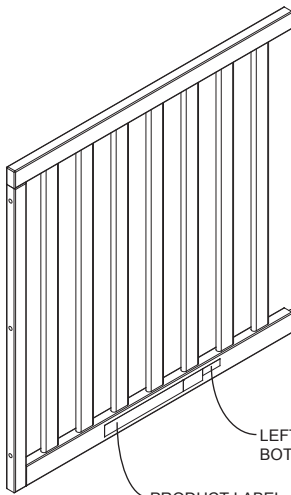

D. Left Crib Side x 1  
Part # 25186

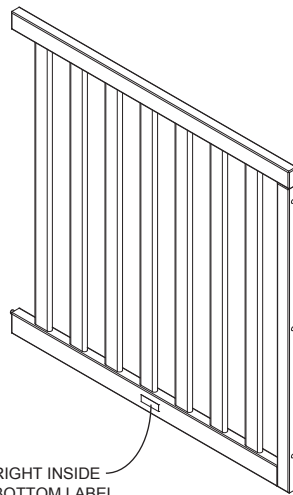

E. Right Crib Side x 1  
Part # 25187



F. Left Back Post x 1  
Part # 25188

G. Right Back Post x 1  
Part # 25189



H. Left Front Post x 1  
Part # 25190



J. Right Front Post x 1  
Part # 25191

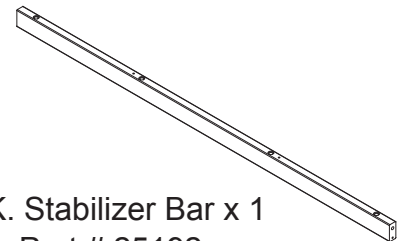

K. Stabilizer Bar x 1  
Part # 25192

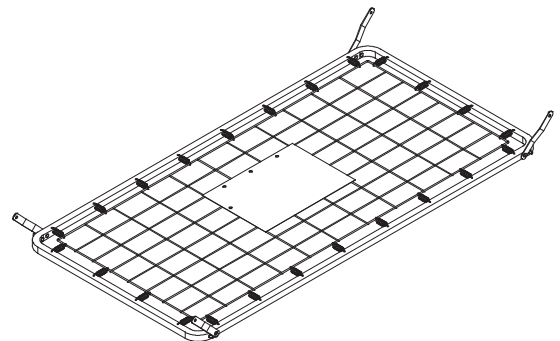

L. Mattress Support x 1  
Part # 21149

POUCH ATTACHED TO MATTRESS SUPPORT  
- KEEP INSTRUCTIONS IN THIS POUCH  
AFTER ASSEMBLY.  
WARNINGS RELATED TO THE SAFE USE OF  
THIS CRIB ARE PRINTED ON THE POUCH.

**PARTS:** HARDWARE KIT IS PART #25193-986 FOR COLOR 100 OR #25193-988 FOR COLOR 204 AND 207. SEE FRONT COVER.

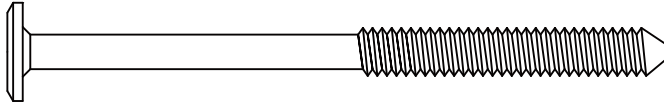
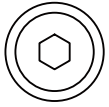

M. M6 x 85 mm Bolt x 10  
Part # 5474

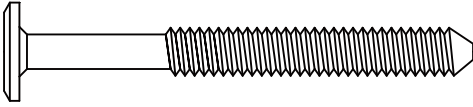
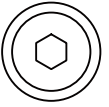

N. M6 x 60 mm Bolt x 4  
Part # 5469

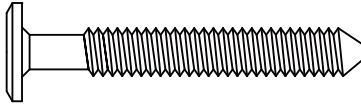
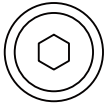

P. M6 x 45 mm Bolt x 6  
Part # 5466

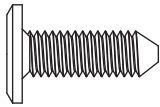
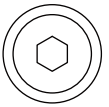

R. M6 x 18 mm Bolt x 8  
Part # 5763

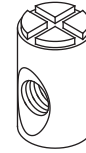

T. M6 x 17mm Barrel Nut x 14  
Part # 5479



S.  $\Phi$ 4x30 mm Metal Pin x 4  
Part # 5493

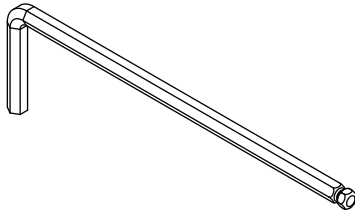

M4 Allen Wrench Supplied  
Part # 1177

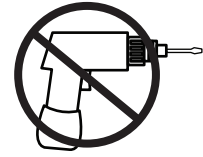

No drills necessary.  
Do not use power  
screwdriver.



Flat Head Screwdriver  
(not supplied)

# Section 1: Crib Assembly

## Step 1

Parts and tools required to complete step.

D. Left Crib Side x 1 G. Right Back Post x 1

J. Right Front Post x 1

M4 Allen Wrench  
Supplied

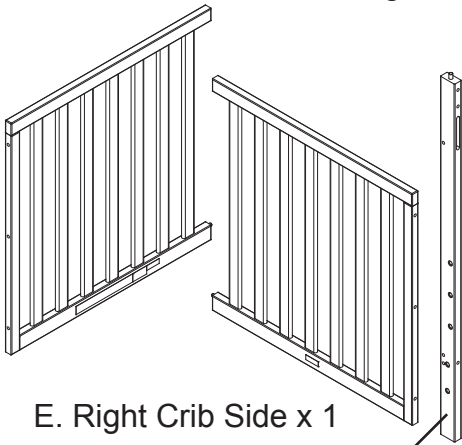

F. Left Back Post x 1

H. Left Front Post x 1



T. M6 x 17mm Barrel Nut x 4

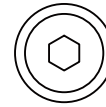

P. M6 x 45 mm Bolt x 6

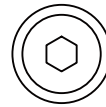

N. M6 x 60 mm Bolt x 4

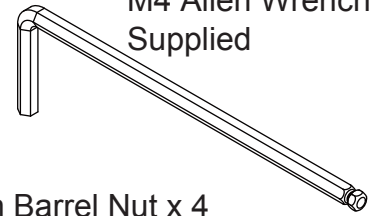

Attach (1) Left Back Post (Part F) and (1) Left Front Post (Part H) to (1) Left Crib Side (Part D) using (3) M6 x 45mm Bolts (Part P), (2) M6 x 60mm Bolts (Part N) and (2) M6 x 17 mm Barrel Nuts (Part T). Tighten with the M4 Allen Wrench. Use the Flat Head Screwdriver to hold the Barrel Nut in the proper alignment. Repeat on the Right Crib Side (Part E), Right Front Post (Part J) and Right Back Post (Part G).

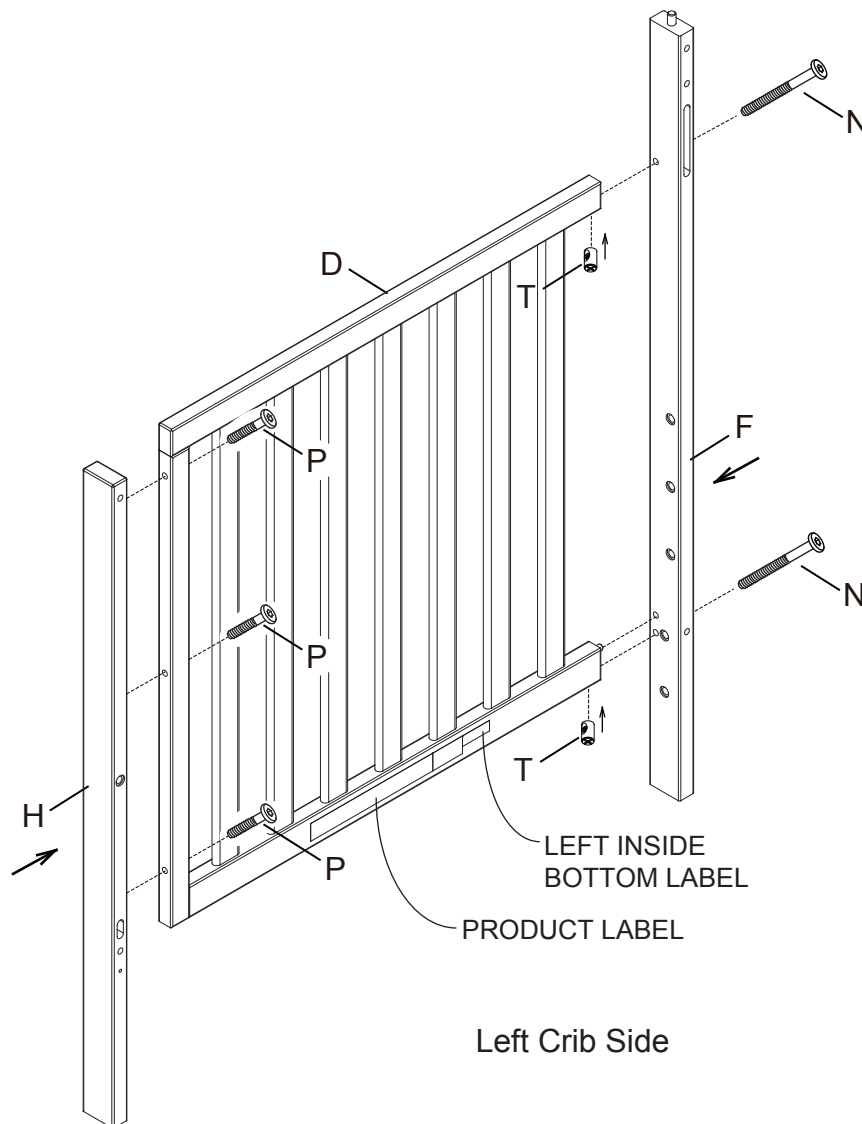

# Section 1: Crib Assembly

## Step 2

Parts and tools required to complete step.

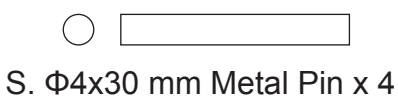
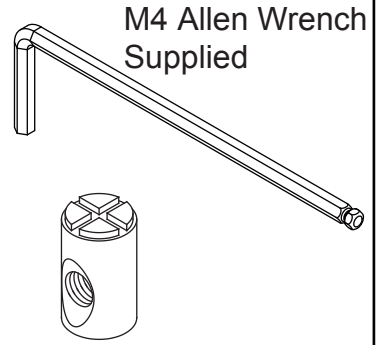
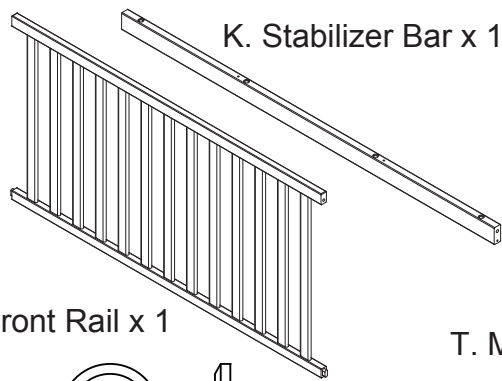
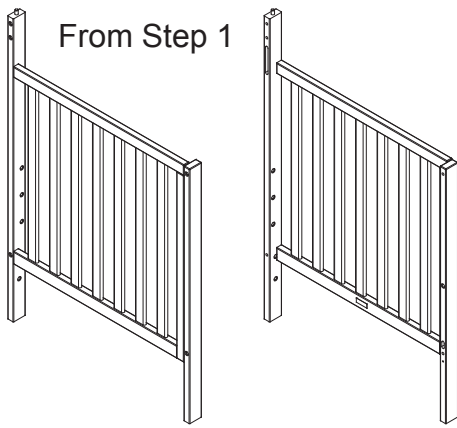

Attach (1) Front Rail (Part C) and (1) Stabilizer Bar (Part K) to the assemblies from step 1 using (4)  $\Phi 4 \times 30$  mm Metal Pins (Part S), (4) M6 x 85 mm Bolts (Part M) and (4) M6 x 17mm Barrel Nuts (Part T). Tighten with the M4 Allen Wrench. Use the Flat Head Screwdriver to hold the Barrel Nut in the proper alignment.

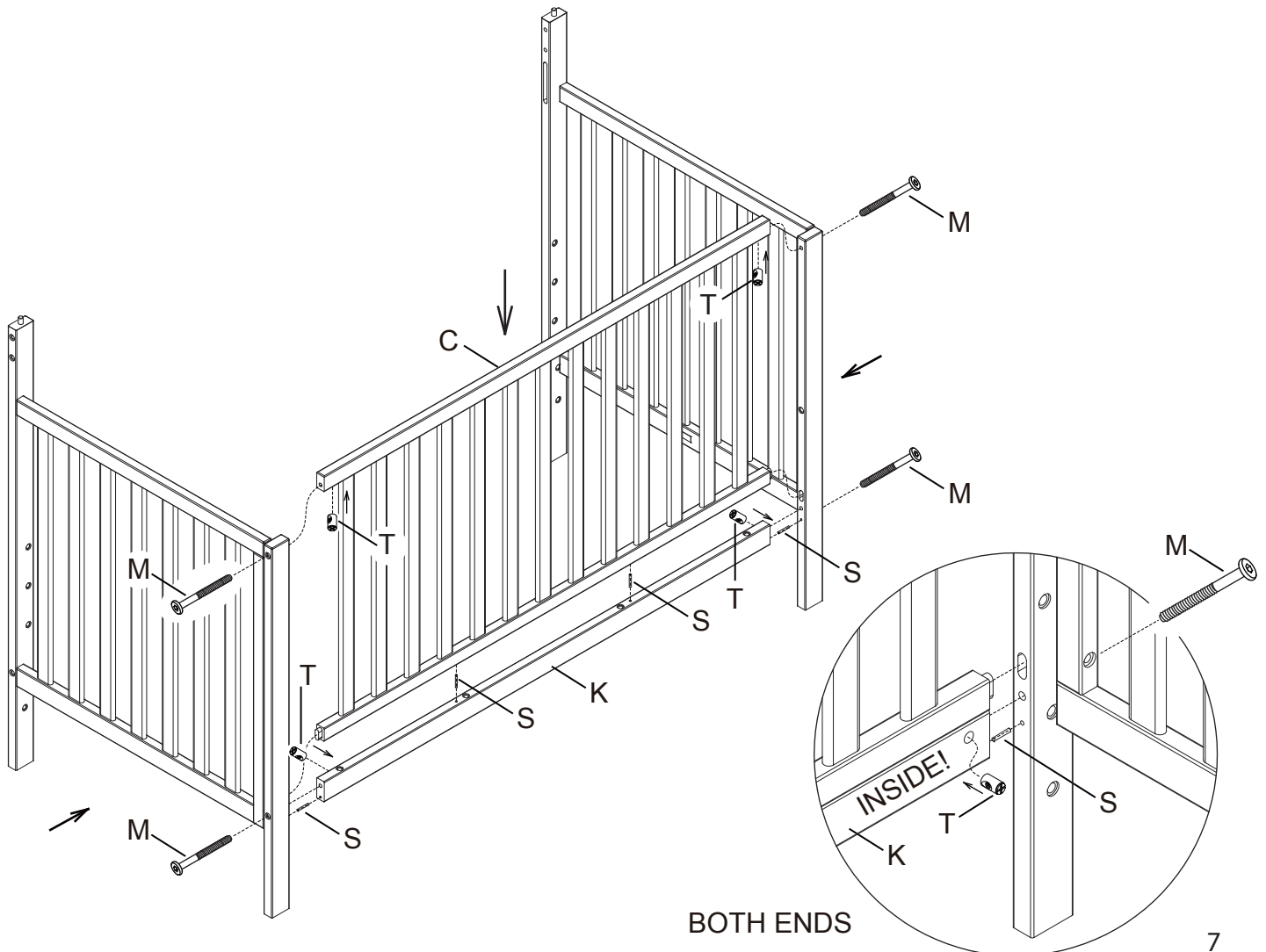

# Section 1: Crib Assembly

## Step 3

Parts and tools required to complete step.

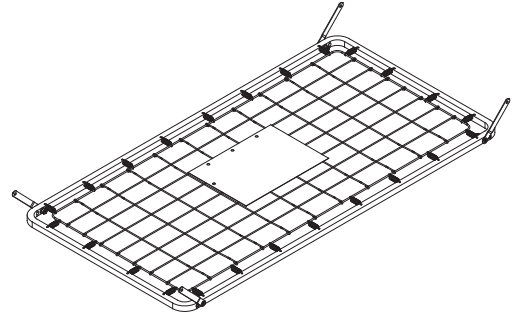
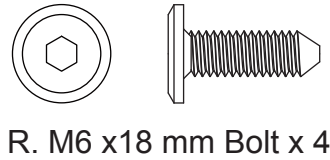
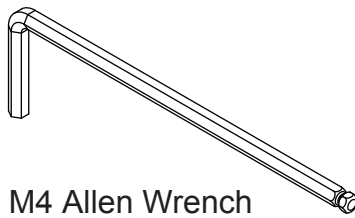
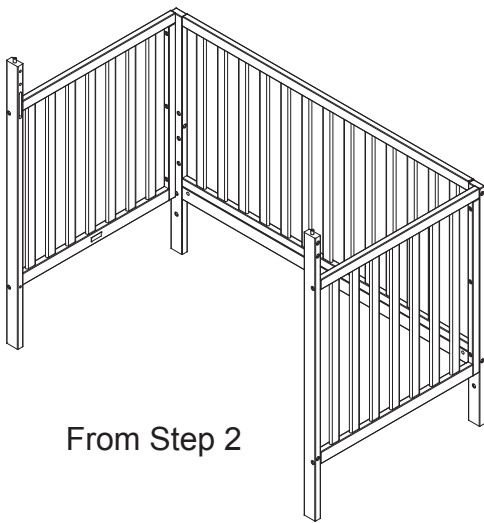

Attach the Mattress Support (Part L) in all corners using (1) M6 x18 mm Bolt (Part R) in each corner. Tighten with the M4 Allen Wrench.

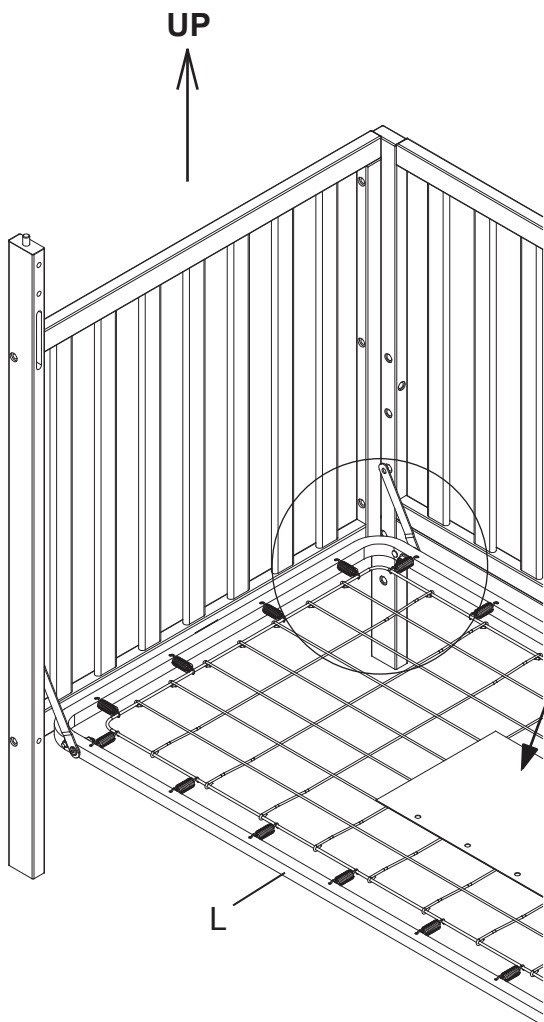

The  Warnings printed on the pouch attached to the mattress support must face up, the springs must face up. This crib has (3) adjustment positions, use the highest only for new borns, move the mattress down as the child grows.

### **WARNING:**

**Fall Hazard:** When child is able to pull to a standing position, set mattress to lowest position and remove bumper pads, large toys and other objects that could serve as steps for climbing out.

 **WARNINGS ON POUCH MUST FACE UP.**

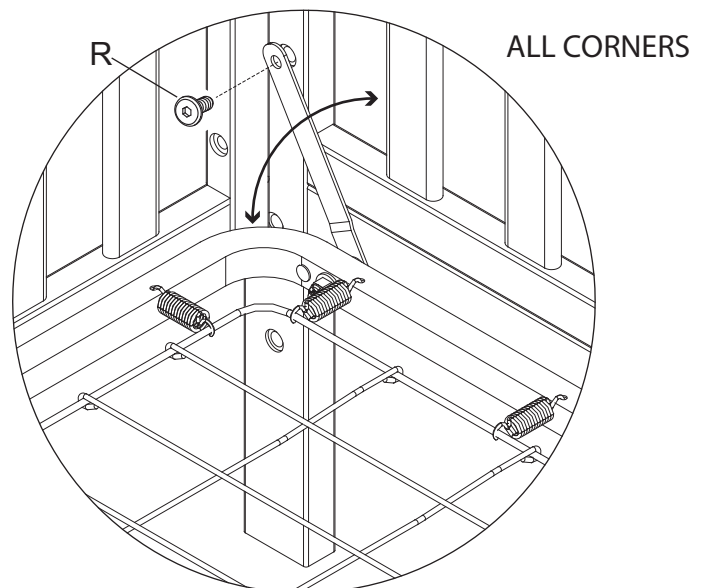



# Section 1: Crib Assembly

## Step 4

Parts and tools required to complete step.

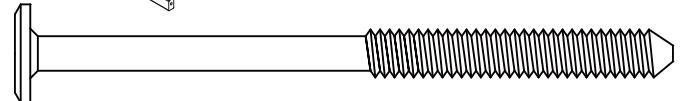
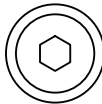
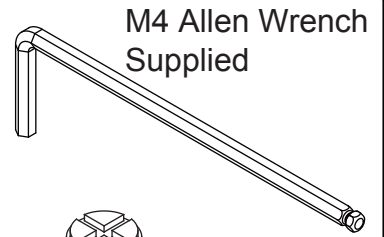
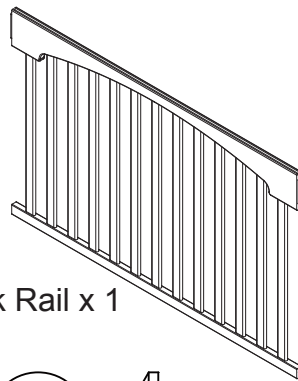

Attach (1) Back Rail (Part B) to the assembly from step 3 using (2) M6 x 85mm Bolts (Part M) and (2) M6 x 17 mm Barrel Nuts (Part T). Tighten with the M4 Allen Wrench. Use the Flat Head Screwdriver to hold the Barrel Nut in the proper alignment.

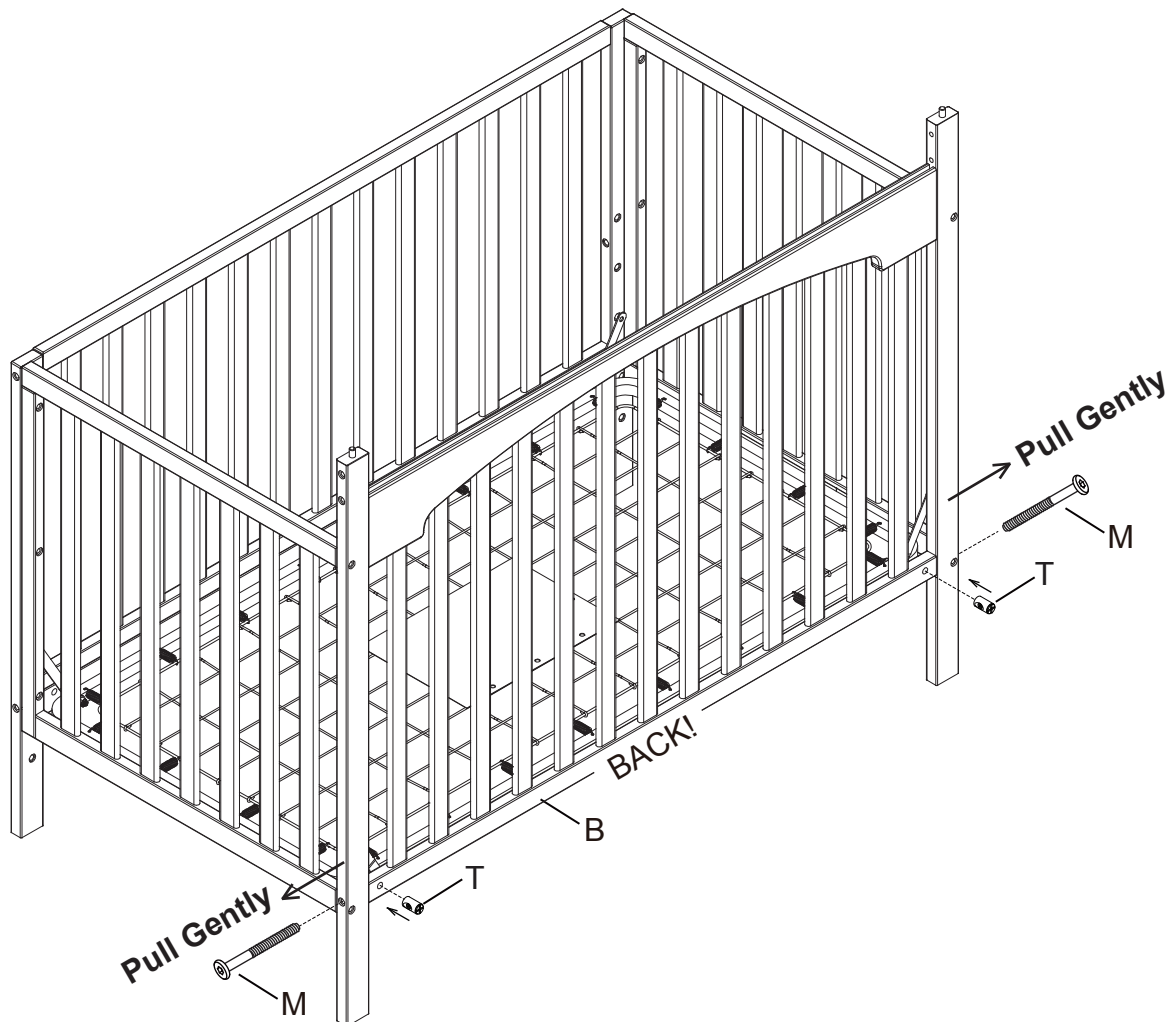

# Section 1: Crib Assembly

## Step 5

Parts and tools required to complete step.



A. Top Back Rail x 1

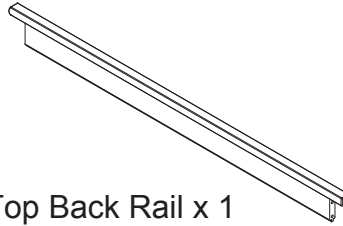

M4 Allen Wrench  
Supplied

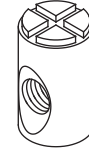
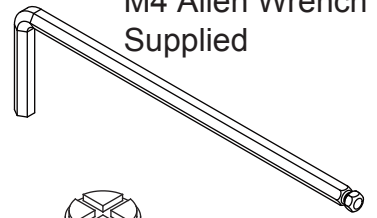

T. M6 x17mm Barrel Nut x 4

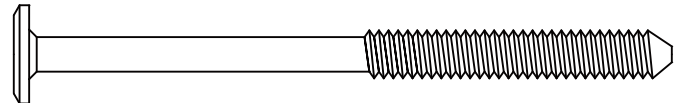
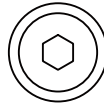

M. M6 x 85 mm Bolt x 4

Attach (1) Top Back Rail (Part A) to the assembly from step 4 using (4) M6 x 85mm Bolts (Part M) and (4) M6 x17 mm Barrel Nuts (Part T). Tighten with the M4 Allen Wrench. Use the Flat Head Screwdriver to hold the Barrel Nut in the proper alignment.

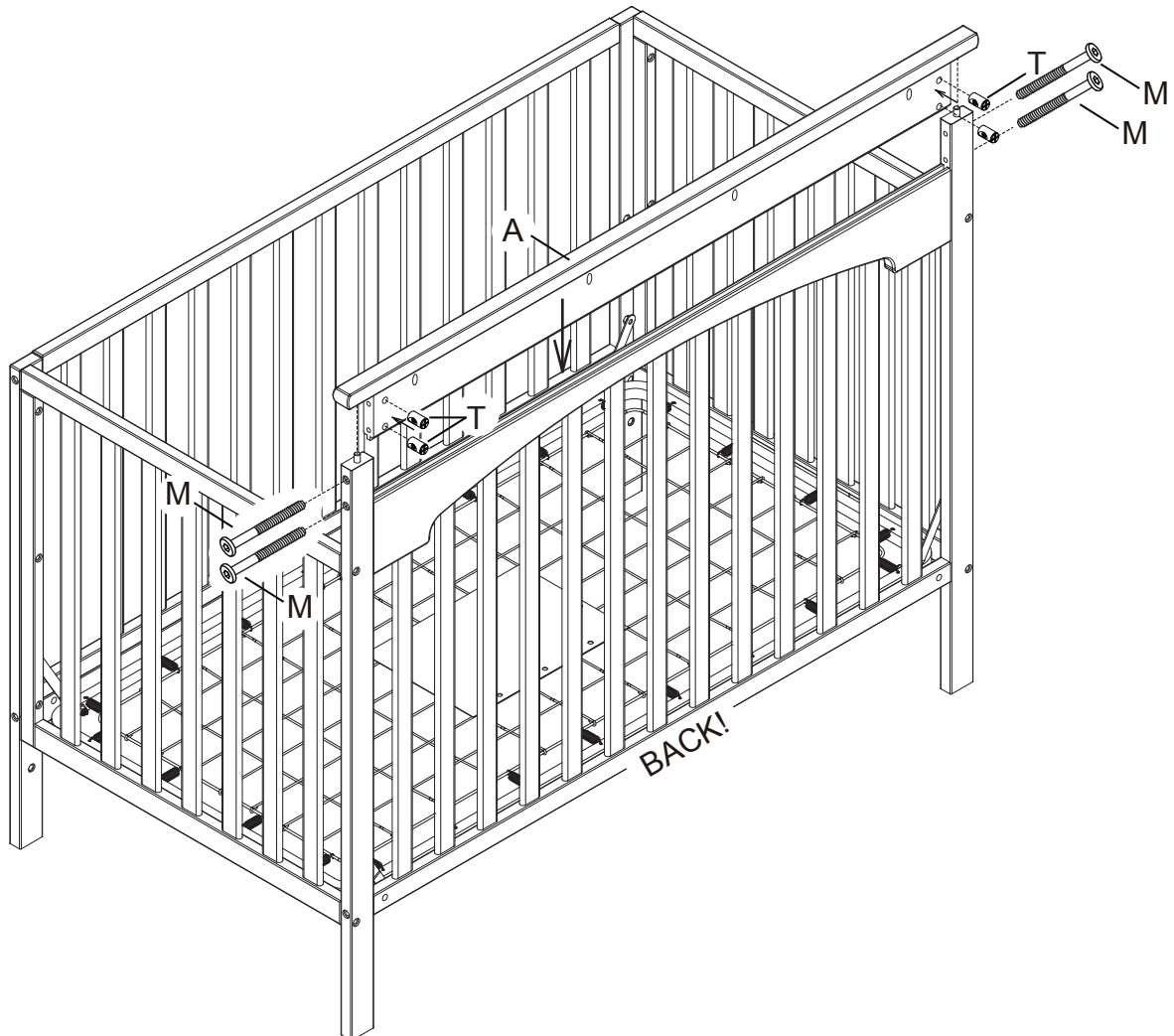

# Section 1: Crib Assembly

## Step 6

Parts and tools required to complete step.



Assembly Instruction Booklet

Store the assembly instruction booklet in the pouch attached to the mattress support. Store all parts and tools separately, in a safe place.

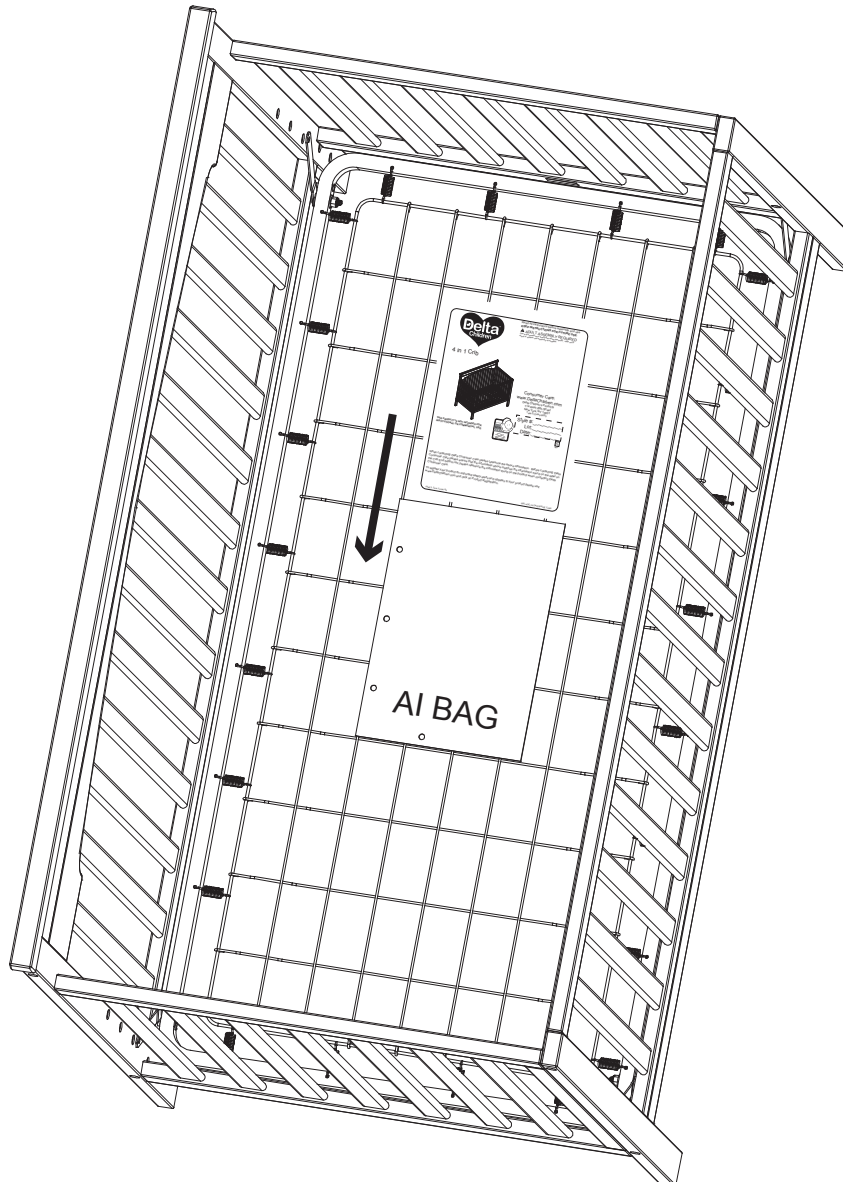

**⚠ WARNING: SEE PAGE 2 FOR INFORMATION**

## Section 2: Toddler Bed Conversion

### Step 1

Parts and tools required to complete step.

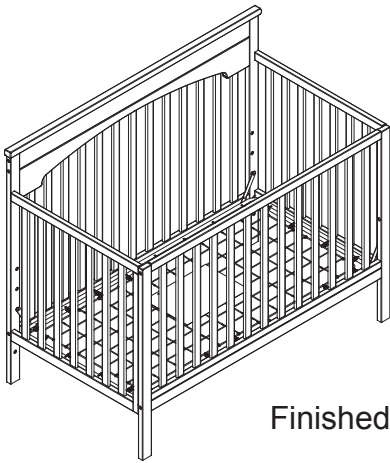

Finished Crib

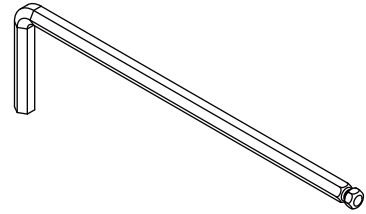

M4 Allen Wrench  
Supplied

Remove the Front Rail and Stabilizer Bar installed in Step 2 of Section 1 crib assembly.

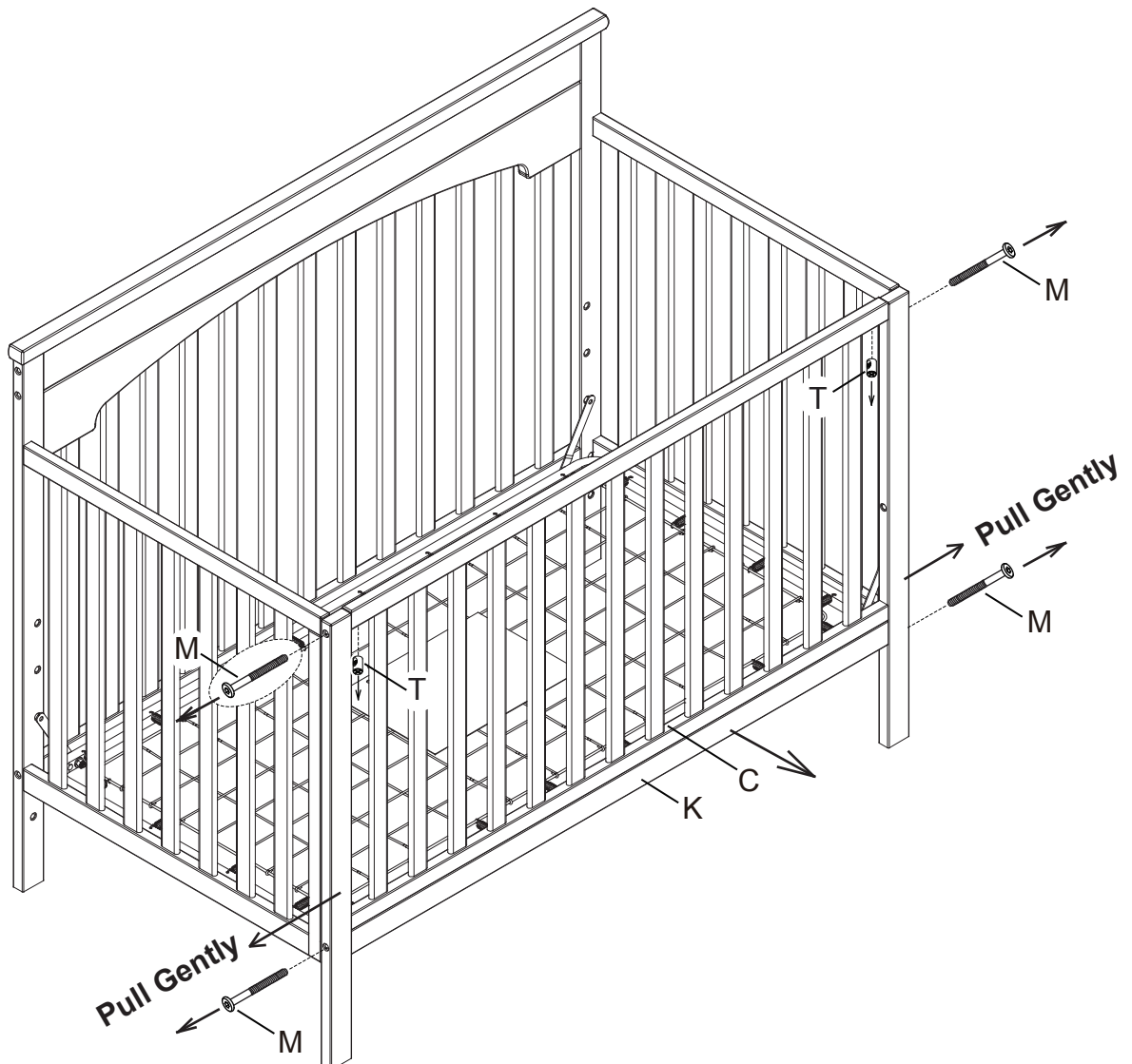

## Section 2: Toddler Bed Conversion

### Step 2

Parts and tools required to complete step.

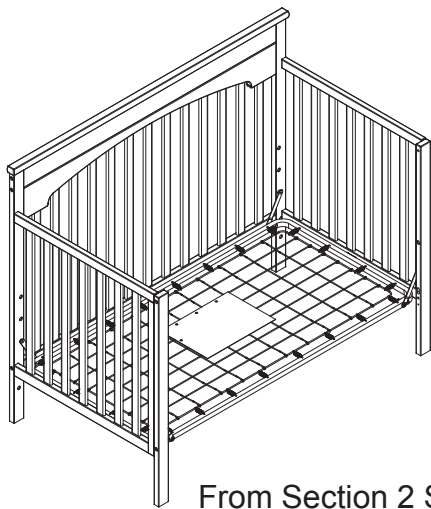

S.  $\Phi 4 \times 30$  mm Metal Pin x 2

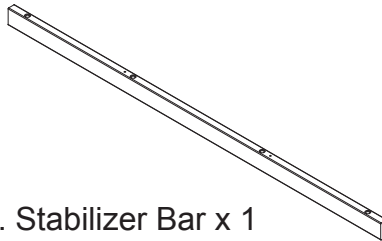

K. Stabilizer Bar x 1

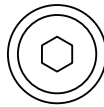

T. M6 x 17mm Barrel Nut x 2

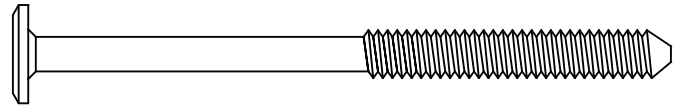

M. M6 x 85 mm Bolt x 2

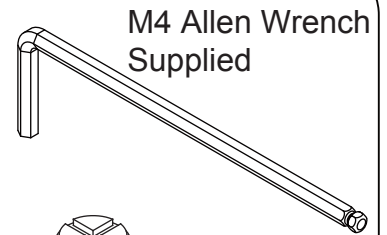

M4 Allen Wrench  
Supplied

Attach (1) Stabilizer Bar (Part K) to the assembly from section 2 step 1 using (2)  $\Phi 4 \times 30$  mm Metal Pins (Part S), (2) M6 x 85 mm Bolts (Part M) and (2) M6 x 17mm Barrel Nuts (Part T). Tighten with the M4 Allen Wrench. Use the Flat Head Screwdriver to hold the Barrel Nut in the proper alignment.

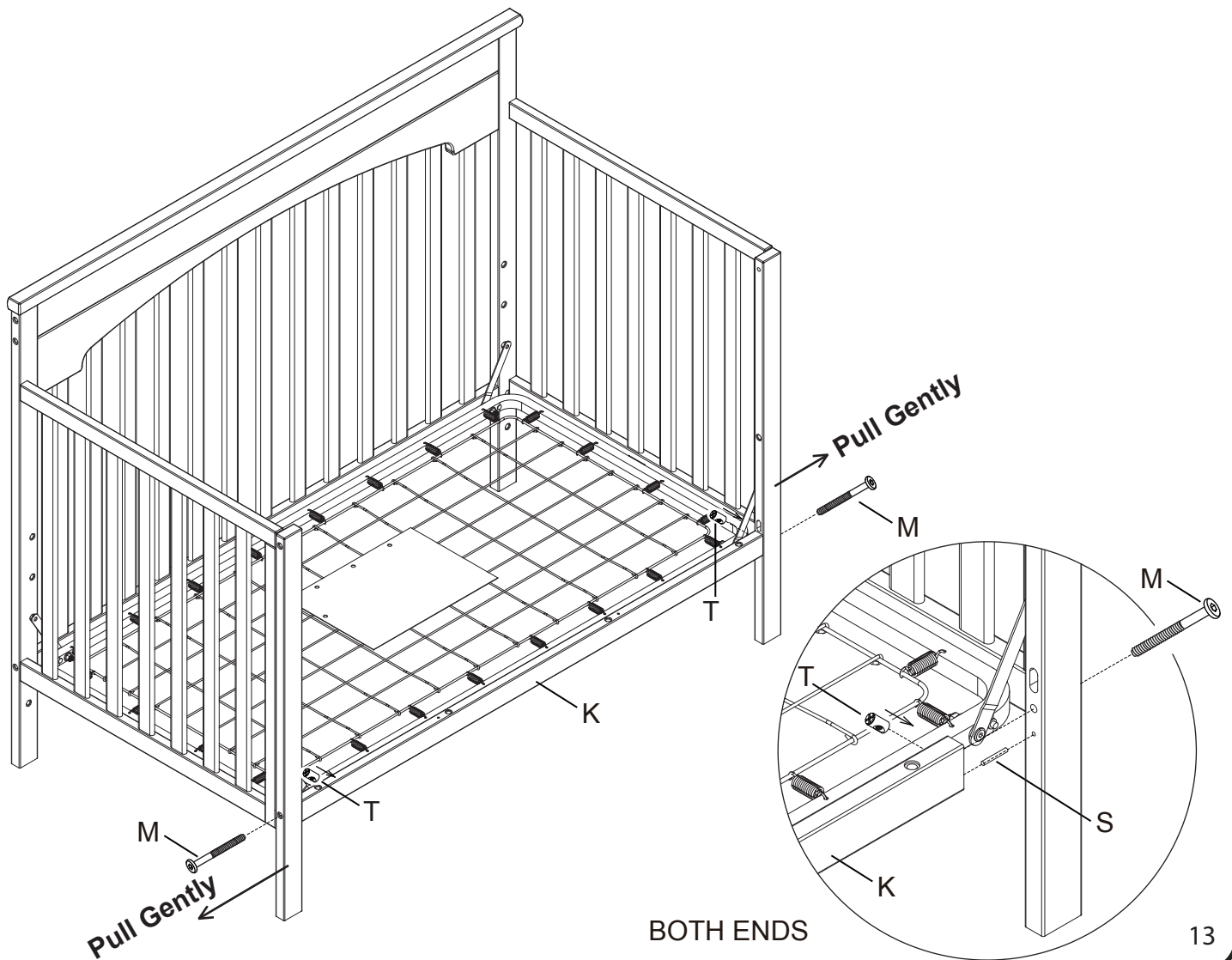

## Section 2: Toddler Bed Conversion Step 3

# **WARNING:** **SEE PAGE 3 FOR** **TODDLER BED WARNINGS**

The mattress support must be in the lowest position.  
Store all hardware safely.  
Read all warnings on page 3.  
As shown, use as a day bed or love seat sofa.  
Do Not use without stabilizer bar installed.

 Stabilizer bar must be used when converted to a toddler bed.



A toddler bed guardrail is available for this crib.  
Please see your crib retailer, visit [www.DeltaChildren.com](http://www.DeltaChildren.com) or contact Delta Consumer Care for more information.  
This crib uses Delta Style # 0080 Guardrail.

# Section 3: Full Size Bed Conversion

## Step 1

Parts and tools required to complete step.

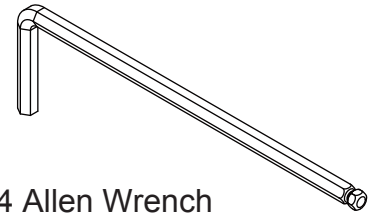

M4 Allen Wrench  
Supplied

You have the option to convert the crib to a Full Size Bed. Simply follow steps in reverse order to disassemble the crib. The Headboard is the Back Rail assembly done through step 4 and 5 of section 1. To create the Footboard, Assemble the Left Front Post (Part H), Right Front Post (Part J), Front Rail (Part C) and Stabilizer Bar (Part K) using (4)  $\Phi 4 \times 30$  mm Metal Pins (Part S), (4) M6 x85mm Bolts (Part M) and (4) M6 x17 mm Barrel Nuts (Part T) as shown. Store all parts and hardware in a safe place.

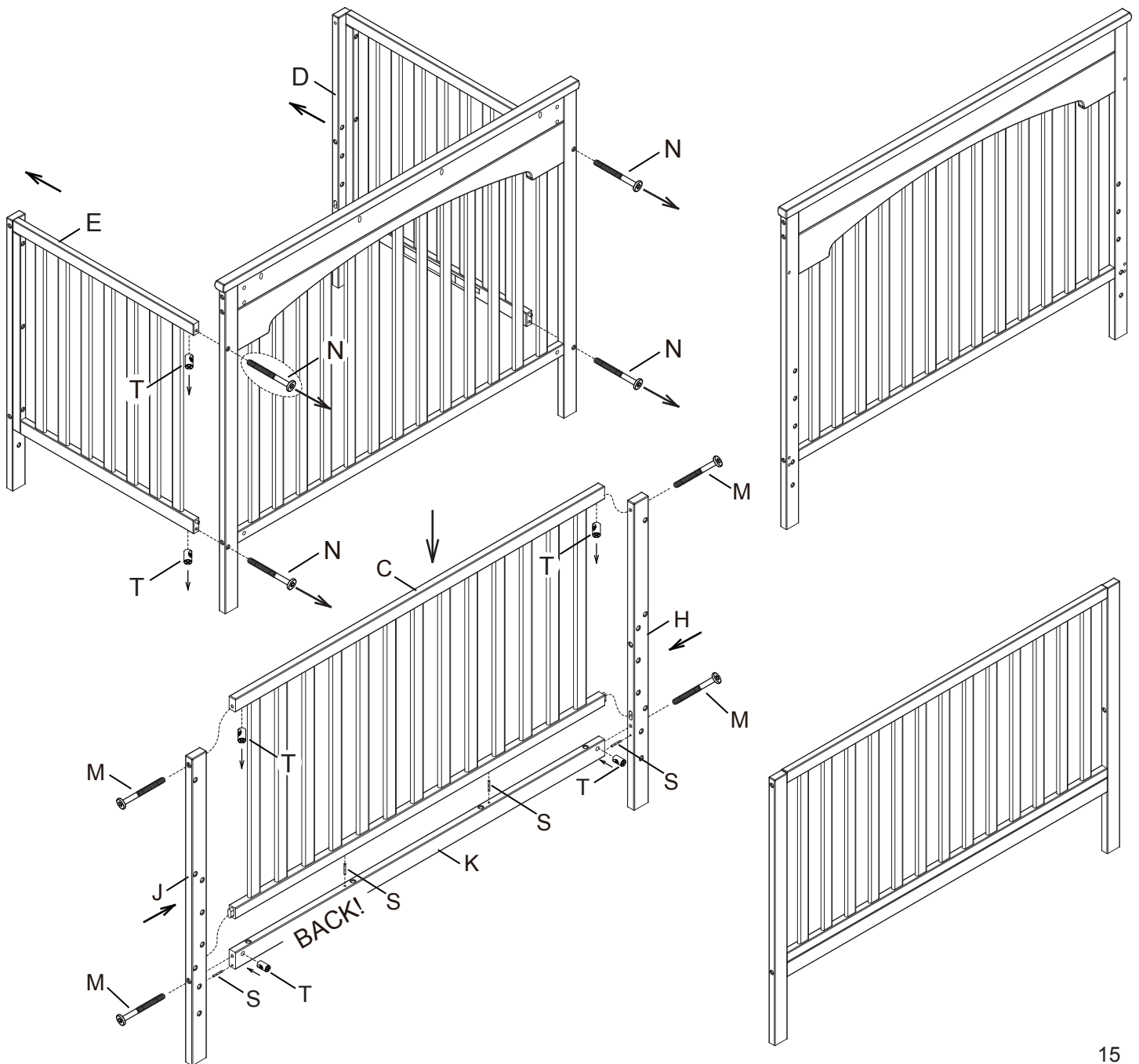

## Section 3: Full Size Bed Conversion

### Step 2

Parts and tools required to complete step.

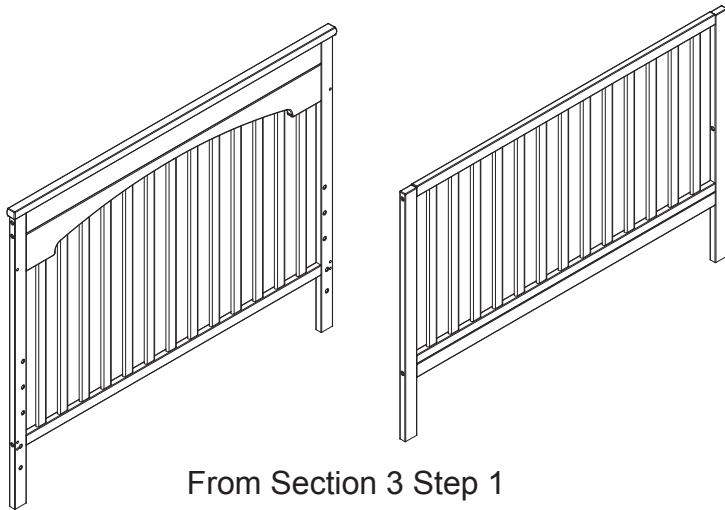

From Section 3 Step 1

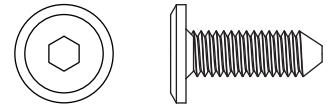

R. M6 x18 mm Bolt x 8

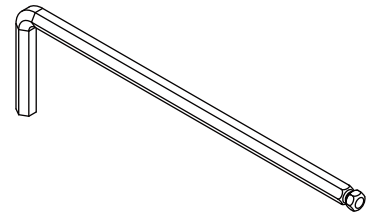

M4 Allen Wrench  
Supplied

Attach Bed Rails to the Headboard (From Section 3 Step 1) and Footboard (From Section 3 Step 1) using (8) M6 x18mm Bolts (Part R). Follow all instructions supplied with the Bed Rails. This crib uses Style # 0050 Conversion Rails to convert to Full Size Bed (pictured below).

**Note:** Bed Rail System is not included, see you furniture or mattress retailer. Contact Delta Children's Products for information or with questions.

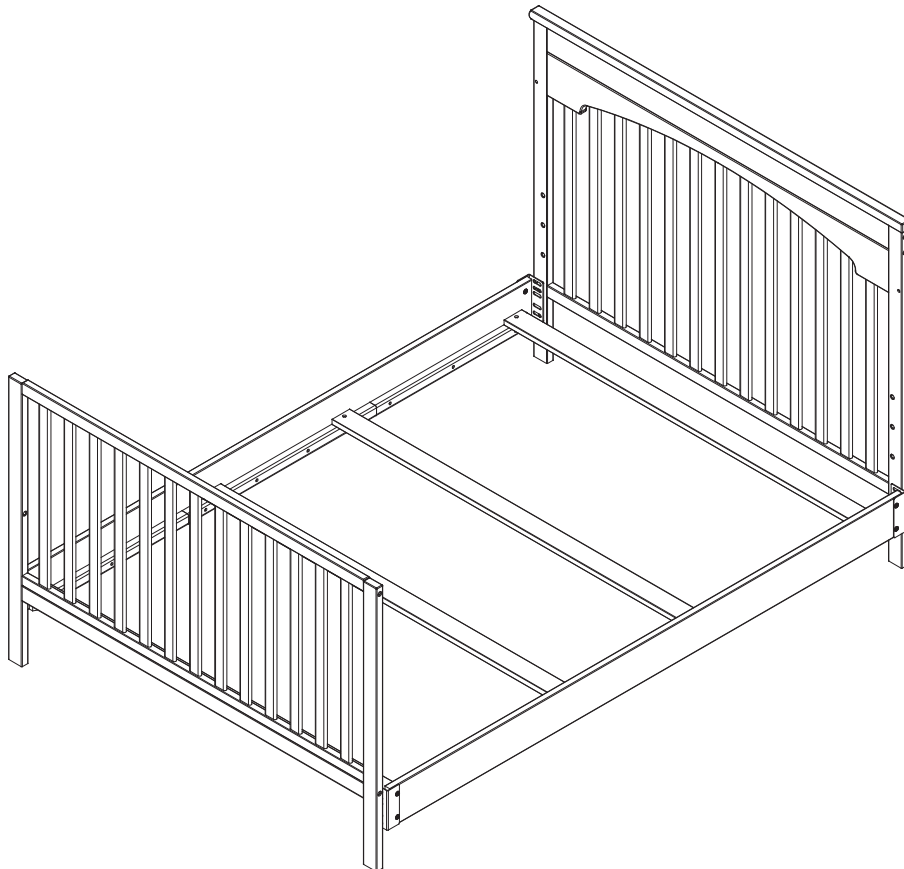

**NOTE: SHOWN AS A FULL SIZE HEADBOARD AND FOOTBOARD, NOT ALL BED RAIL SYSTEMS ALLOW USE OF A FOOTBOARD.**

As an alternative this item can be set up with only a headboard using Delta Item #0040 Metal Bed Frame (not pictured).





Consumer Care:  
[www.DeltaChildren.com](http://www.DeltaChildren.com)  
Delta Children's Products  
114 West 26th Street  
New York, NY 10001  
Tele.212-645-9033

**Warranty:** This Delta Crib is warranted to be free from defects for a period of 1 year from the date of purchase under normal use. This warranty extends only to the original retail purchaser and is valid only when supplied with proof of purchase, or if received as a gift, when the registration is on file with Delta.

To register your product for important safety alerts and updates to your product please visit **[www.DeltaChildren.com](http://www.DeltaChildren.com)**

Please do not return this item to the store before contacting us about missing parts or with any questions.

To report a problem, please log on to **[www.DeltaChildren.com](http://www.DeltaChildren.com)** and click the Consumer Care Tab, or contact us by phone at (212) 645-9033.

In the event that you need to contact our customer service department please have the Style Number and Lot Number available. Use the space below to make note of those numbers. They can be found on the label on the Crib End bottom rail.

**STYLE No: 602150**

COLOR

REV

FTY

Lot No. : \_\_\_\_\_

Pack Date: \_\_\_\_\_

Date of Purchase: \_\_\_\_\_ (you should also keep your receipt)