

DELTA♥CHILDREN™ Ottoman

Read all instructions before assembly and use.

KEEP INSTRUCTIONS FOR FUTURE USE.



To Make Assembly Even Easier Watch Video Here!

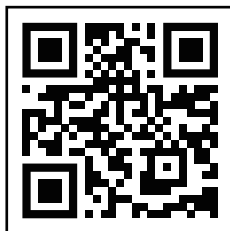

For Questions or to Contact Us:

DeltaChildren.com/Help

If unable to access website, please email wcs@DeltaChildren.com

Expect longer response times via email.

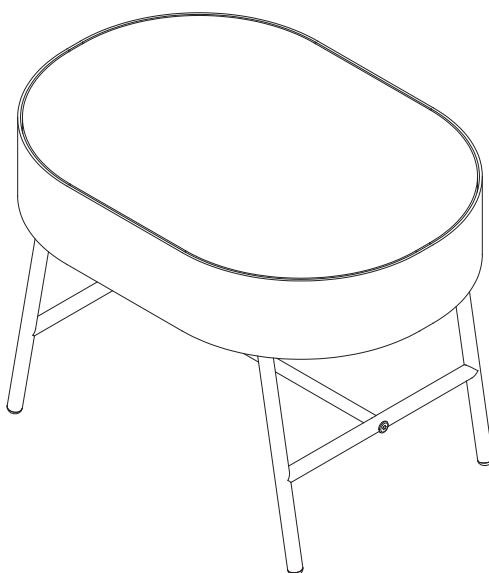

Style #: _____
A Lot: _____
REV Date: _____

Before contacting Delta Consumer Experience Center please ensure this information matches the information found on the label on the Seat Base.



ADULT ASSEMBLY REQUIRED

Due to the presence of small parts during assembly, keep out of reach of children until assembly is complete.

This product is not intended for institutional or commercial use.

August 12, 2020, 41272, R0

Lea todas las instrucciones antes de ensamblar y usar.

MANTENGA LAS INSTRUCCIONES PARA SU USO FUTURO.



Para facilitar más aun el ensamblaje ver el video aquí

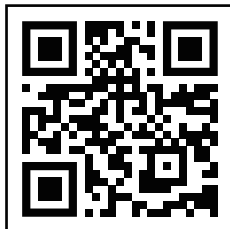

Para preguntar o para contactarnos :

DeltaChildren.com/Help

Si no puede acceder el sitio web, por favor envíenos un email a wcs@DeltaChildren.com

El tiempo de espera para respuestas será más largo por email.

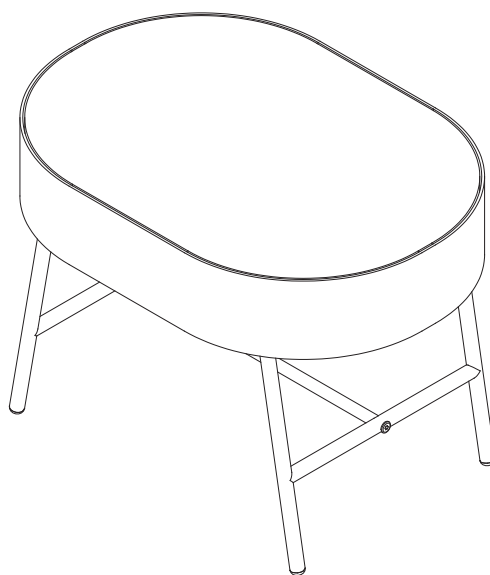

DEBE SER ENSAMBLADO POR UN ADULTO

Debido a la presencia de piezas pequeñas durante el ensamblaje, mantenga fuera del alcance de los niños hasta que complete el ensamblaje.

Este producto no esta hecho para uso institucional o comercial.

Antes de contactar el Centro de Experiencia del Consumidor de Delta por favor asegúrese de que la información de la primera página coincida con la información que se encuentra en la etiqueta ubicada en el base.

Fabric Care Instructions:

- When cleaning a spill, blot immediately to remove spilled material.
- Use a water based soap that combines 1 tablespoon of a liquid detergent such as Tide with 16 ounces of lukewarm water. Dampen the cleaning cloth in the mixture and gently blot the soiled area. Avoid rubbing the affected area aggressively. Rinse the area with a clean, damp cloth to ensure all of the soap residue has been removed.
- Do not use solvents to clean. Do not use bleach.
- Do not over wet.
- Clean spots or stains from the outside to the middle of the affected area to prevent circling.
- Pile fabrics may require brushing with a non-metallic, stiff bristle brush to restore appearance.
- Cushion covers should not be removed and laundered.
- To prevent overall soiling, frequent vacuuming or light brushing with a non-metallic, stiff bristle brush to remove dust and grime is recommended.
- Use a professional furniture cleaning service when an overall soiled condition has been reached.
- Hot water extraction or steam cleaning is not a recommended cleaning method.

Instrucciones para el cuidado de la tela:

- Cuando se limpie un derrame, secar inmediatamente para quitar el material derramado.
- Utilice un jabón a base de agua, combinando una cucharada de detergente líquido con 16 onzas de agua tibia. Humedecer un trapo limpio de tela con la mezcla y tocar suavemente el área manchada. Evitar restregar enérgicamente el área afectada. Enjuagar el área con un trapo limpio y húmedo para asegurarse de que no quede residuo de jabón.
- No utilizar solventes para limpiar manchas. No utilice blanqueadores.
- No mojar demasiado
- Limpiar las manchas desde la parte externa hacia la mitad del área afectada para evitar que queden círculos.
- Las telas afelpadas podrían ser cepilladas con un cepillo de cerdas rígidas y no metálicas para restaurar su apariencia original.
- Las coberturas de los cojines no deben ser quitadas y lavadas.
- Se recomienda pasarle la aspiradora frecuentemente o cepillar suavemente con un cepillo de cerdas rígidas y no metálicas para quitar el polvo y la suciedad.
- Cuando esté en condiciones de total suciedad , contratar a un servicio profesional de limpieza de muebles.
- No se recomienda utilizar métodos de limpieza con extracción de agua caliente o limpieza con vapor.

SAVE BIG WITH DELTA CHILDREN

Visit **Deltachildren.com** To Start Shopping

Welcome to the
DELTA FAMILY
Here's a Gift From Us To You

**10%
OFF**

Your Next Purchase From
DeltaChildren.com

USE CODE:
DELTA10

*Exclusions Apply
*Subject to Change

REVIEW TO WIN \$2500

RULES TO ENTER



"We LOVE, LOVE, LOVE this crib"

My husband was impressed with the directions and organization of the hardware package. He easily assembled this crib in an hour without any help. It's very sturdy and we like that it has adjustable levels for the mattress height. To top it all off, it's so incredibly darling!!!

- 1** **WRITE A REVIEW** for this product on the store's website from where it was purchased
- 2** **TAKE A SCREENSHOT** of your review and upload it to www.DeltaChildren.com/Review
- 3** **IT'S THAT EASY!** Upon submission, you'll be instantly **ENTERED TO WIN \$2,500**

FOLLOW US FOR MORE CHANCES TO WIN

   
@deltachildren

SCAN HERE



For more
information &
to see all of
our products

AHORRE MUCHO CON DELTA CHILDREN

Visita **Deltachilren.com** Para Comenzar A Comprar

Bienvenido a la
FAMILIA DELTA

Aquí Está Nuestro Regalo
Para Usted

**10%
OFF**

Su Próxima Compra En
DeltaChildren.com

UTILICE EL CÓDIGO:
DELTA10

*Exclusions Apply
*Subject to Change

CALIFIQUE EL PRODUCTO PARA **GANAR \$2500**

REGLAS PARA PARTICIPAR



- 1 **CALIFIQUE EL PRODUCTO** en la página web de la tienda donde haya sido comprado
- 2 **HAGA UNA CAPTURA DE PANTALLA** de su calificación y cárguela a la pagina www.DeltaChildren.com/Review
- 3 **ES ASÍ DE FÁCIL!** En cuanto lo envíe ya estará instantáneamente **PARTICIPANDO PARA GANAR \$2.500**

SÍGANOS PARA TENER MAS CHANCES DE GANAR



@deltachildren

ESCANEE AQUÍ

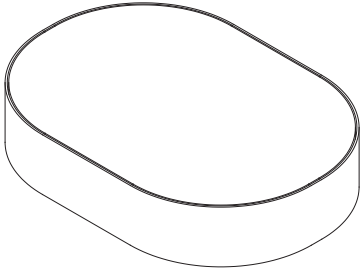

Para más
información
y para ver todos
nuestros productos

PARTS: MAKE SURE THAT ALL PRE-ASSEMBLED PARTS ARE TIGHT
PIEZAS: ASEGÚRESE DE QUE TODAS LAS PIEZAS PRE-ENSAMBLADAS ESTÁN BIEN APRETADAS.

**A**

Ottoman Cushion x 1
Cojín de la Ottoman x 1
41269

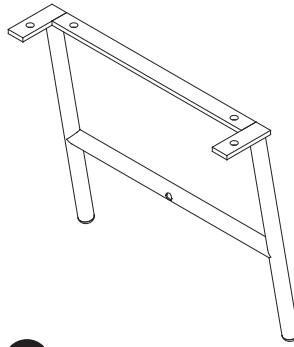
**B**

Base Frame x 2
Estructura de la Base x 2
41270

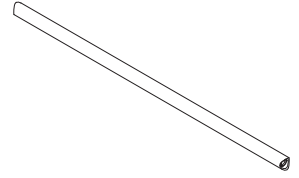
**C**

Base Rail x 1
Barra del Base x 1
41271

PARTS: HARDWARE KITS PART#41258

PIEZAS: EL KIT DE HERRAMIENTAS - PIEZA #41258

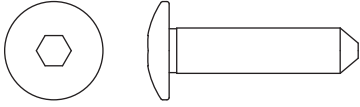

- D** M6 x 25 mm Button Head Bolt x 8
Perno de Cabeza de Botón M6x25mm x 8
6151

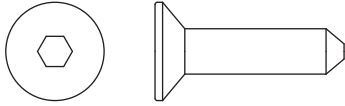

- E** M6 x 25 mm Flat Head Bolt x 2
Perno de Cabeza Plana M6x25mm x 2
6152

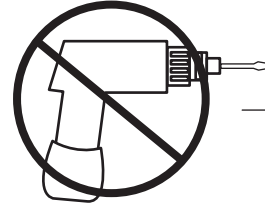

No drills necessary.
Do not use power screwdriver.

No hace falta taladrar.
No utilice destornilladores eléctricos



M4 Allen Wrench (Provided)
Llave Allen M4 (se Incluye)
1908

STEP 1 PASO 1

Parts and tools required to complete step

Piezas y herramientas necesarias para completar este paso

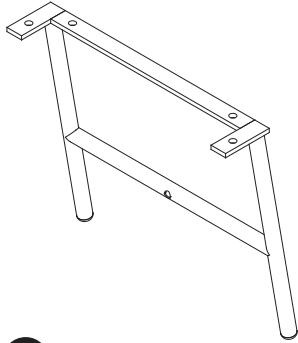

B

Base Frame x 2
Estructura de la Base x 2

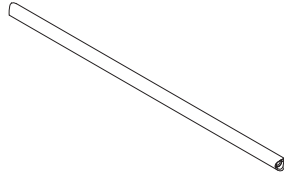

C

Base Rail x 1
Barra del Base x 1

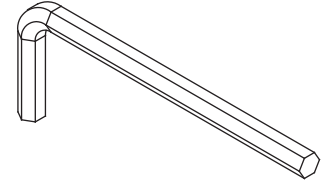

M4 Allen Wrench (Provided)
Llave Allen M4 (se Incluye)

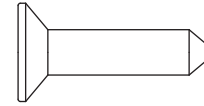
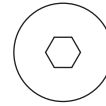

E

M6 x 25 mm Flat Head Bolt x 2
Perno de Cabeza Plana M6x25mm x 2

Attach the Base Rail (Part C) to the Base Frames (Part B) using (2) M6x25mm Flat Head Bolts (Part E). Tighten with the M4 Allen Wrench.

Fije (1) Barra del Base (Pieza C) al (2) Estructura de la Base (Pieza B) utilizando (2) Pernos de Cabeza Plana M6x25mm (Pieza E). Apretar con la llave Allen M4.

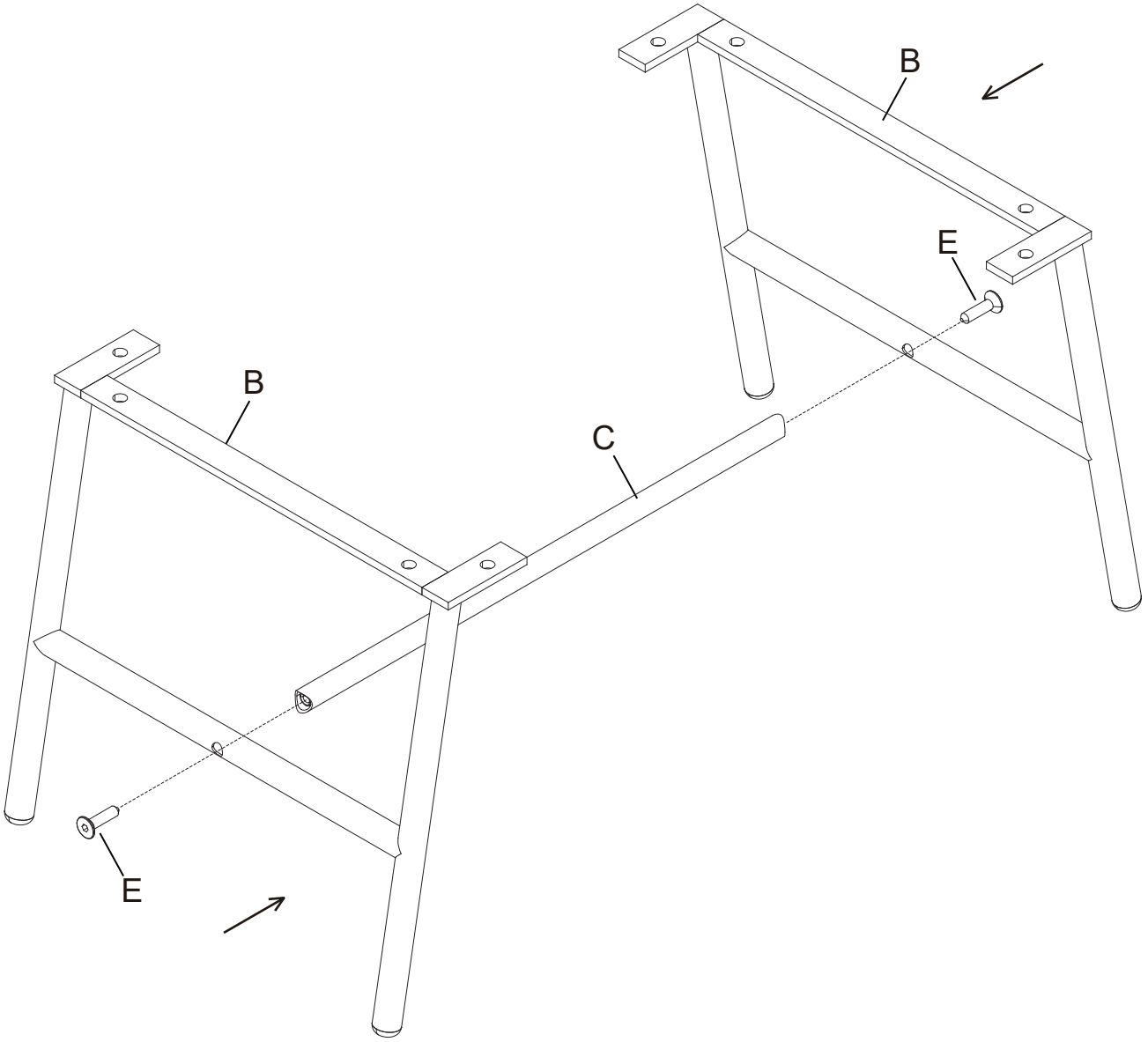

STEP 2 PASO 2

Parts and tools required to complete step

Piezas y herramientas necesarias para completar este paso

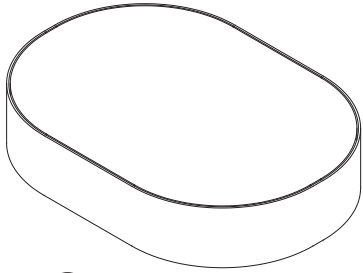

A

Ottoman Cushion x 1
Cojín de la Ottoman x 1

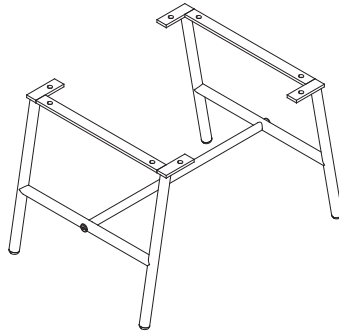

From Step 1
Desde el paso 1

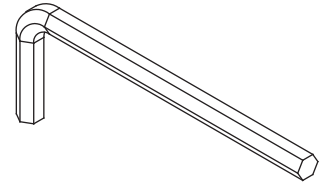

M4 Allen Wrench (Provided)
Llave Allen M4 (se Incluye)

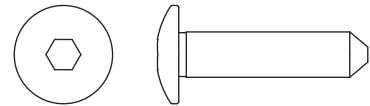

D

M6 x 25 mm Button Head Bolt x 8
Perno de Cabeza de Botón M6x25mm x 8

Attach the assembly from step 1 to the Ottoman Cushion (Part A) using (8) M6 x 25 mm Button Head Bolts (Part D). Tighten with the M4 Allen Wrench.

Fije el conjunto de piezas del paso 1 al Cojín de la Ottoman (Pieza A) utilizando (8) Pernos de Cabeza de Botón M6x25mm (Pieza D). Apretar con la llave Allen M4.

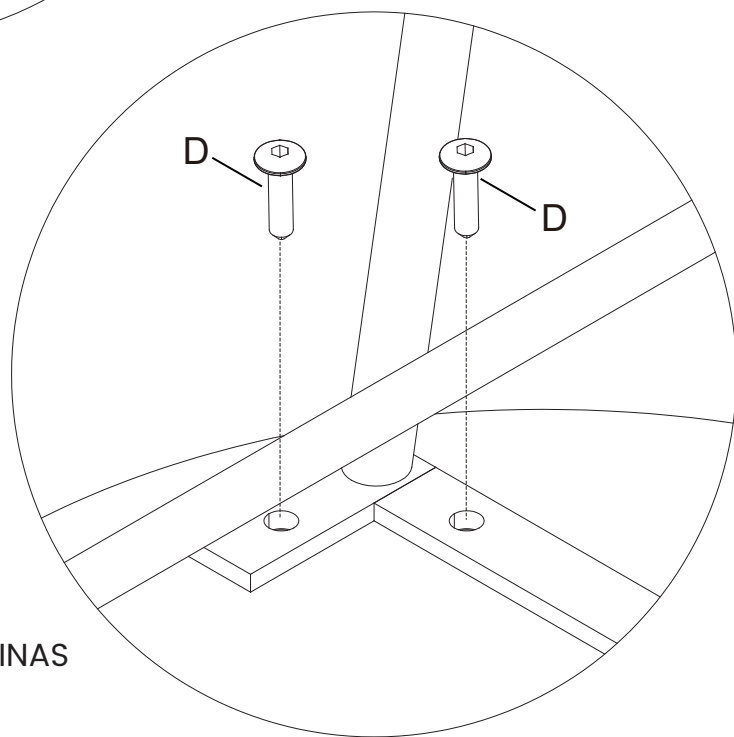
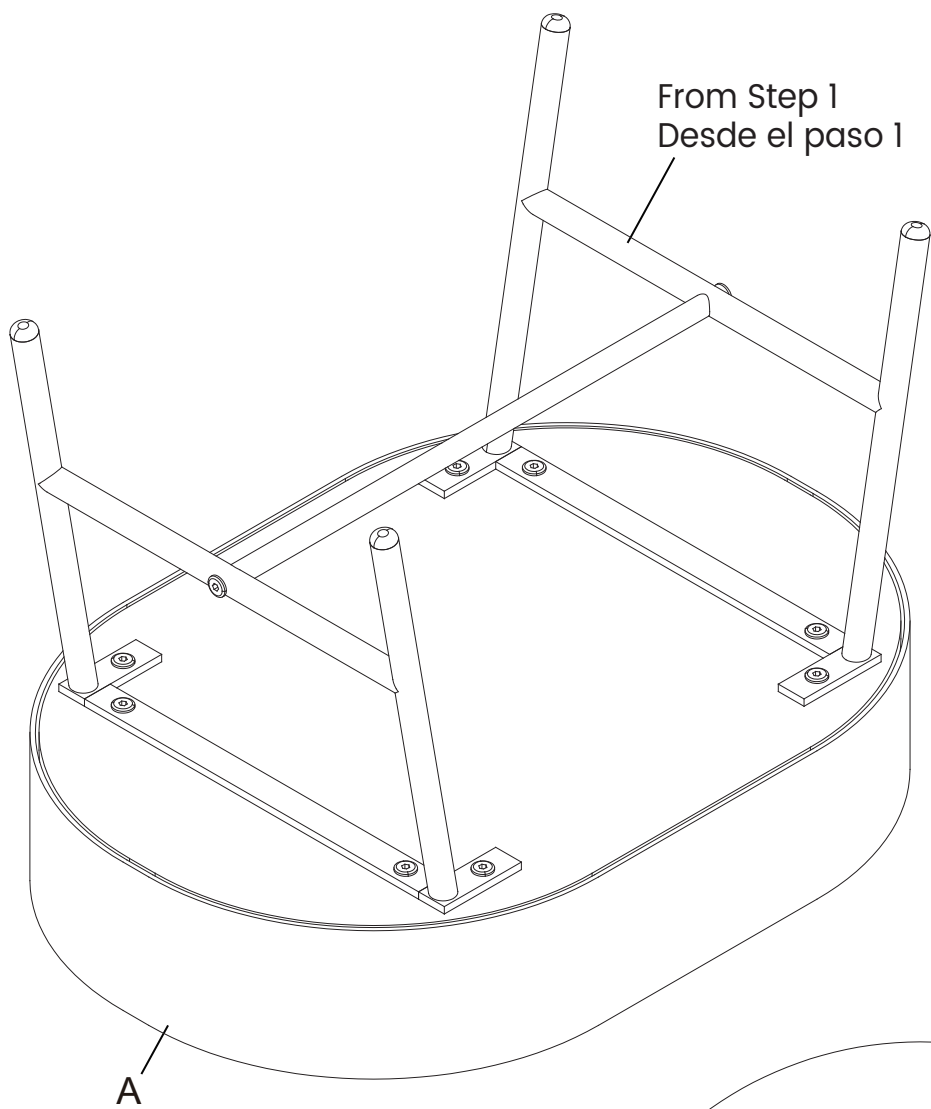

ALL CORNERS
TODAS LAS ESQUINAS

Limited Warranty:

This Delta Crib is warranted to be free from defects for a period of 90 days from the date of purchase under normal use. If a product is defective during this period, we will at our option repair or replace the defective part or product. This limited warranty extends only to the original retail purchaser and is valid only when supplied with proof of purchase, or if received as a gift, when the registration is on file with Delta. This limited warranty does not cover the following:

- Products purchased as floor models or samples.
- Items purchased on an “as-is” basis, as a second hand product, or as a resale product.
- Items purchased at a Final sale, a “Going out of Business” sale or a Liquidation sale.

This limited warranty gives you specific legal rights and you may also have other rights which vary from state to state.

To register your product

for important safety alerts and updates to your product please visit
www.deltachildren.com

To report a problem

please log on to www.deltachildren.com/help

Date of Purchase: _____ (you should also keep your receipt)

Garantía Limitada:

Este Cuna Delta está garantizado de estar libre de defectos por un período de 90 días a partir de su adquisición, bajo uso normal. Si un producto tiene defectos durante este período, Nosotros tomaremos la opción de reparar o reemplazar la pieza defectuosa del producto. Esta garantía limitada se otorga únicamente al comprador original y es válida solamente cuando se proporciona una prueba de compra, o si el producto fue recibido como un regalo, debe haber sido registrado con Delta. Esta garantía limitada del fabricante no cubre lo siguiente:

- Productos comprados como exhibiciones de la tienda o muestras.
- Artículos comprados como “tal como está”, productos de segunda mano o reventa de los productos.
- Artículos comprados como “venta final”, “ventas de tiendas que están quebrando” o ventas por liquidación.

Esta garantía limitada le otorga derechos legales específicos y también puede tener otros derechos que varían de un estado a otro.

Para registrar su producto

para alertas importantes de seguridad y estar al tanto sobre novedades de su producto por favor visite
www.DeltaChildren.com

Para reportar cualquier problema

por favor entre a www.DeltaChildren.com/help

Fecha de Compra: _____ (debe además mantener su recibo)

POR QUÉ ELEGIR A DELTA CHILDREN?

Visita Deltachildren.Com/Pages/Our-Story para más información

<p>DELTA LIDERA 1 de cada 2 niños en los EE.UU duerme en nuestros productos</p>	<p>DELTA DONA 10% de nuestros ingresos está destinado a mejorar la vida de los niños</p>	<p>A DELTA LE IMPORTA Hacemos pruebas por encima de los estándares de seguridad de la industria</p>	<p>DELTA ESTÁ DEDICADA Nuestra empresa familiar ha estado siempre presente para su familia desde 1968</p>	<p>DELTA CRECE CON USTEDES Tenemos productos para cada edad y etapa</p>	<p>Más De 50 Años De Seguridad, Estilo E Innovación</p>
--	---	--	--	--	--

Bienvenido a la **FAMILIA DELTA**
Aquí Está Nuestro Regalo Para Usted

10% OFF

Su Próxima Compra En DeltaChildren.com

UTILICE EL CÓDIGO:
DELTA10



PRODUCTOS PARA CADA EDAD Y ETAPA

 CUNAS	 COSAS PARA BEBÉ	 SILLA	 MOISÉS	 COLCHÓN	
 CARRIOLAS	 CAMA PARA NIÑO	 CUARTO DE JUGAR	 CAMA SENCILLA	 CONTENEDORES	 TOCADORES

NUESTRA FAMILIA DE LAS MEJORES MARCAS



MÁS DE 50 AÑOS DE SEGURIDAD, ESTILO E INNOVACIÓN

WHY CHOOSE DELTA CHILDREN?

Visit Deltachildren.Com/Pages/Our-Story for more information

<p>DELTA LEADS 1 Out Of 2 Children In The U.S. Sleep In Our Products</p>	<p>DELTA GIVES 10% Of Our Profits Go Toward Improving The Lives Of Children</p>	<p>DELTA CARES We Test Above & Beyond Industry Safety Standards</p>	<p>DELTA IS DEDICATED Our Family-Run Company Has Been There For Your Family Since 1968</p>	<p>DELTA GROWS WITH YOU We Have Products For Every Age And Stage</p>	<p>Over 50 Years Of Safety, Style & Innovation</p>
---	--	--	---	---	---

Welcome to the **DELTA FAMILY**
Here's a Gift From Us To You

10% OFF

Your Next Purchase From DeltaChildren.com

USE CODE:
DELTA10

*Exclusions Apply
*Subject to Change

PRODUCTS FOR EVERY AGE AND STAGE

 CRIBS LITS POUR BÉBÉ CUNAS	 STROLLERS ÉQUIPEMENT POUR BÉBÉ COSAS PARA BEBÉ	 GLIDERS CHAISE SILLA	 BASSINETS COUFFINS MOISÉS	 MATRESSES MATELAS COLCHÓN	
 BABY GEAR POUSSETTES CARRIOLAS	 TODDLER BEDS LITS POUR ENFANT CAMA PARA NIÑO	 PLAYROOM FURNITURE SALLE DE JEUX CUARTO DE JUGAR	 TWIN BEDS LITS UNE PLACE CAMA SENCILLA	 BINS & ORGANIZERS PANIERES CONTENEDORES	 DRESSERS COMMODES TOCADORES

OUR FAMILY OF TOP BRANDS



OVER 50 YEARS OF SAFETY, STYLE, AND INNOVATION