

# 36 X 36 PLAY YARD

DELTA♥CHILDREN

## INSTRUCTION MANUAL

**36002, 26003  
26004, LF40062**

**Styles and colors may vary**

*\*26004 Model Shown*



**⚠ WARNING:  
CHOKING HAZARD**

Adult assembly required because of small parts. Keep assembly parts out of reach of children under 3 years.

**Read all instructions BEFORE assembly and USE of product  
KEEP INSTRUCTIONS FOR FUTURE USE.**

Customer Experience Center  
email: [gcs@DeltaChildren.com](mailto:gcs@DeltaChildren.com)

DELTA♥CHILDREN

[www.DeltaChildren.com](http://www.DeltaChildren.com)

DCP-IM-10122020

# Consumer Information



## WARNING

**WARNING:** Failure to follow these warnings and the instructions could result in serious injury or death (keep the instructions for future reference). Before assembling this play yard read and understand the instructions, incorrect assembly may make the play yard unsafe.

### **SUFFOCATION HAZARD – Infants can suffocate:**

- In gaps between a mattress (too small or too thick) and product sides.
- On soft bedding
- **NEVER** add a mattress, pillow, comforter or padding. Use **ONLY** the pad provided by the manufacturer.
- **Never leave infant in product with sides down.** Infant may roll into spaces between pad and loose mesh side causing suffocation.
- Strings can cause strangulation! Never place items with a string around a child's neck such as hood strings or pacifier cords. Never suspend strings over product or attach strings to toys.
- The product, including side rails, must be fully erected prior to use. Make sure latches are secure.
- **NEVER** leave infant in the product with the top rail latches unlatched in the unlocked position. Be sure top rail latches are raised and latched into the locked position whenever the child is in the product.
- Discontinue use of the product when child is able to climb out or reaches the height of 35 in (890 mm).
- **NEVER** place product near a window where cords from blinds or drapes can strangle a child. **DO NOT** place the play yard near trailing cables or hanging cords.
- Always provide the supervision necessary for the continued safety of your child. When used for playing, never leave child unattended.
- **DO NOT** use the play yard if the fabric on the side rail or end rails has been ripped or torn through.
- Use only the pad provided by the manufacturer. Play yard pad dimensions are 37.25 in (946.15mm) long by 37.25 in (946.15mm) wide.
- To reduce the risk of Sudden Infant Death Syndrome (SIDS), pediatricians recommend healthy infants be placed on their backs to sleep, unless otherwise advised by your physician.
- **NEVER** use plastic shipping bags or other plastic film as mattress covers not sold and intended for that purpose. They can cause suffocation.
- **NEVER** use a water mattress with this product.
- Keep medication and small items that a child could choke on away from the play yard.
- Child can become entrapped and die when improvised netting or covers are placed on top of a play yard. Never add such items to confine child in play yard.
- When child is able to pull to standing position, remove bumper pads, large toys, and other objects that could serve as steps for climbing out.
- Use this product with only one child at a time.

## Care and Maintenance

- The frame, mattress pad, and storage bag may be wiped clean using a mild cleaning solution and a damp cloth.
- Do not use bleach.
- Do not use harsh or abrasive cleaners.
- Rinse clean with water to remove residue.
- Do not immerse the product.
- Drip dry.



## **Before returning this product to the store! Let's see if we can assist you!**

- **Not sure how to assemble our product?**

Visit our site for easy to follow instructions along with some Tricks and Tips assembly videos <https://www.deltachildren.com/pages/instructions>

- **If you are missing a piece or have a damaged part**

Please contact our Consumer Experience Center for assistance at [gcs@DeltaChildren.com](mailto:gcs@DeltaChildren.com). To better assist you please have your Style# or Model# and Lot# available. This can be found on a white rectangular sticker on your product, on the registration card, and on the product's box.

- **In the event we do not have a replacement part available**

You may need to return your product to the retailer for an exchange or refund.

- **Warranty**

In order to protect your investment, don't forget to register your product. You may also wish to consider purchasing our extended warranty.

Visit <https://www.deltachildren.com/pages/extended-warranty> for more details.

- **Please note:**

"All Final", "As Is" or Third Party/Liquidator sales are not covered under our Limited Manufacturer Warranty.

# DELTA CHILDREN

## LIMITED MANUFACTURER WARRANTY

This Delta product is warranted to be free from defects for a period of 90 days from the date of purchase under normal use. If a product is defective during this period, we will at our option repair or replace the defective part or product. This limited warranty extends only to the original retail purchaser and is valid only when supplied with proof of purchase, or if received as a gift, when the registration is on file with Delta.

This limited warranty does not cover the following:

- Products purchased as floor models or samples.
- Items purchased on an “as-is” basis, as a second hand product, or as a resale product.
- Items purchased at a Final sale, a “Going out of Business” sale, or a Liquidation sale. This limited warranty gives you specific legal rights and you may also have other rights which vary from state to state.

This limited warranty gives you specific legal rights and you may also have other rights which vary from state to state.

**TO REGISTER YOUR PRODUCT** for important safety alerts and updates to your product please visit [www.deltachildren.com](http://www.deltachildren.com)

**TO REPORT A PROBLEM**, please log on to [www.deltachildren.com](http://www.deltachildren.com) and click the Consumer Care Tab, or contact us by email at [gcs@DeltaChildren.com](mailto:gcs@DeltaChildren.com)

Date of Purchase: \_\_\_\_\_ (you should also keep your receipt)

## EXTENDED WARRANTY

### DON'T MISS YOUR CHANCE TO BE COVERED FOR ALL OF LIFE'S MISHAPS!

With Delta's Extended Warranty, you're covered for mechanical failure from normal use or if your item stops working due to normal wear and tear, plus all those unexpected surprises.

## 2 YEARS OF PROTECTION

**For Additional Information:**

**Simply visit our Website, register your product, and add the Extended Warranty**

**<https://www.deltachildren.com/pages/product-registration>**

Extended Warranty only available in the following States: Arkansas, Colorado, Delaware, District of Columbia, Georgia, Idaho, Illinois, Indiana, Iowa, Kansas, Kentucky, Louisiana, Maryland, Michigan, Mississippi, Missouri, Nebraska, Nevada, New Hampshire, New York, North Carolina, North Dakota, Pennsylvania, Rhode Island, South Dakota, Tennessee, Utah, West Virginia

# Consumer Information

## INFORMATION

**IMPORTANT!** Before assembly or each use, inspect this product for damaged hardware, loose joints, missing parts, torn mesh / fabric, or sharp edges. DO NOT use if any parts are missing, torn, or broken.

Contact manufacturer for replacement parts and instructions if needed. Never substitute parts. Make sure all locking devices are engaged.

- Adult assembly is required.

## Parts

**IMPORTANT!** Please remove all parts from the package and identify them before assembly.

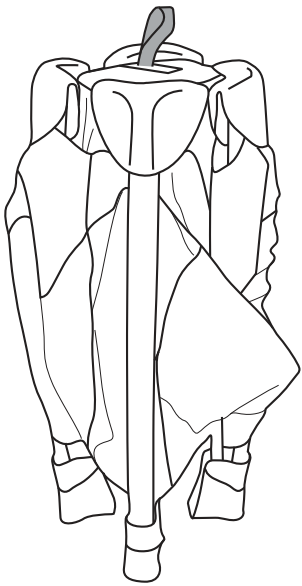

Play yard

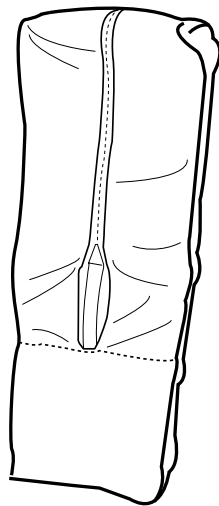

Travel and Storage Bag

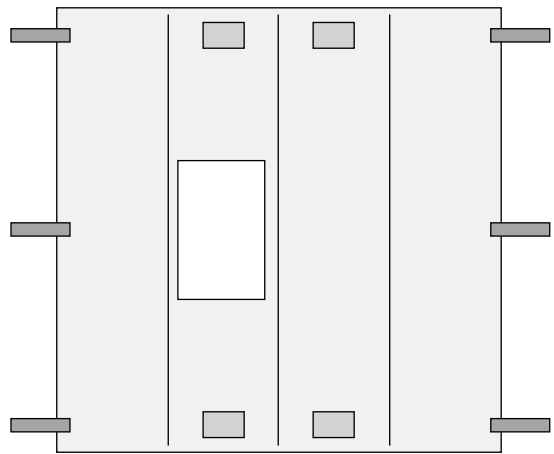

Mattress Pad

# Play Yard Assembly and Use

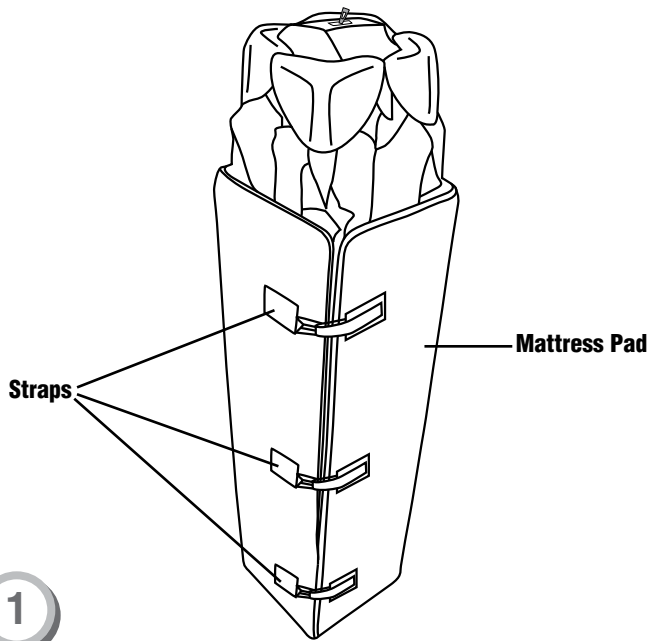

- Unfasten the straps on the mattress pad.
- Remove the play yard from inside the mattress pad.

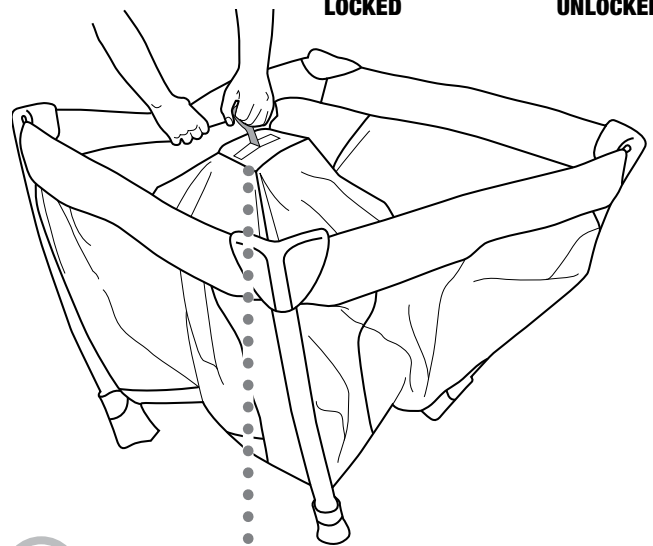
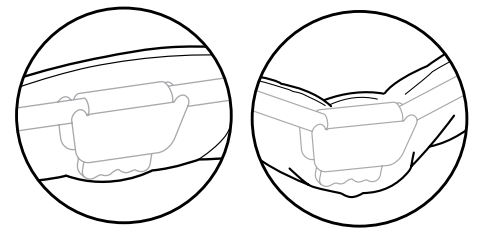

• Minimum Distance: 18 inches from the floor

- Make sure the center hub is raised at least 18 inches.
- Grasp the center of each side rail then lift to “snap” into locked position.
- If “snapping” of the side rail locks does not occur easily, recheck that the center hub is up to recommended height before proceeding.

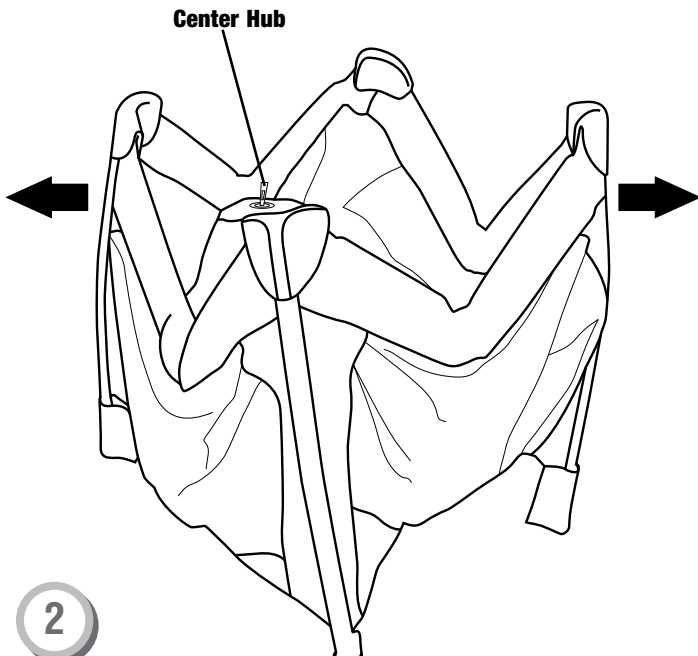

- Carefully pull the side rails out.
- IMPORTANT!** Do not push down on the center hub. you will do this in step 4.

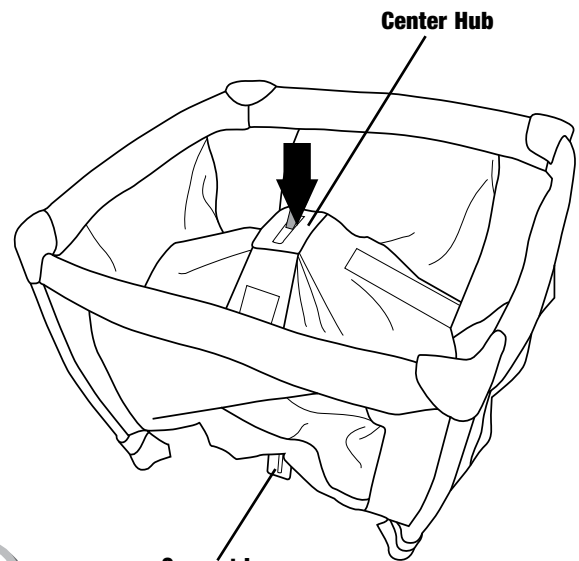

- Press down on the center hub to lock it into the use position.
- IMPORTANT!** You may need to pull the support legs outwards to allow center hub to be pushed down.

# Play Yard Assembly and Use

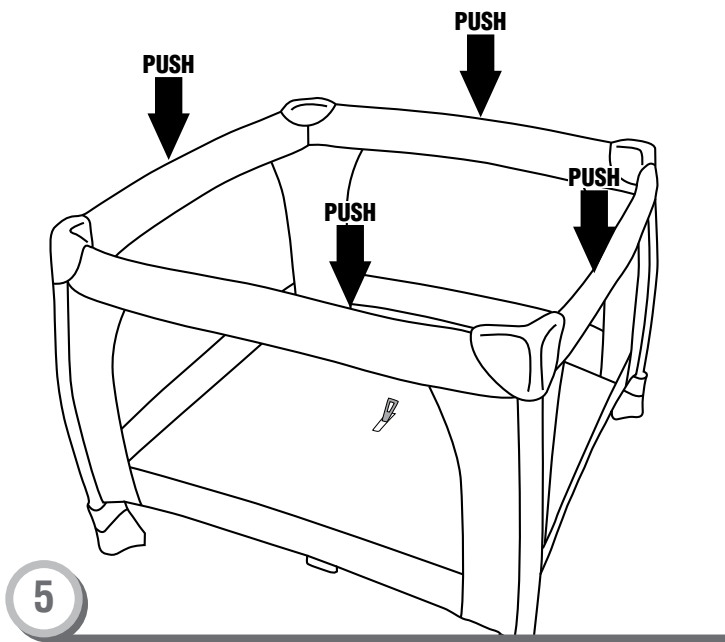

**IMPORTANT!** Check to be sure the play yard frame is secure. Push down on the side rails.

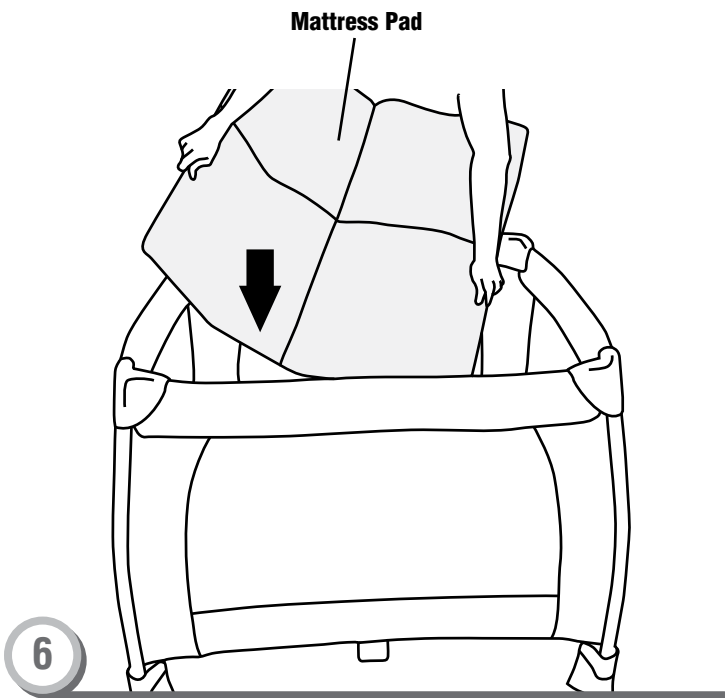

• Place mattress pad in the play yard.

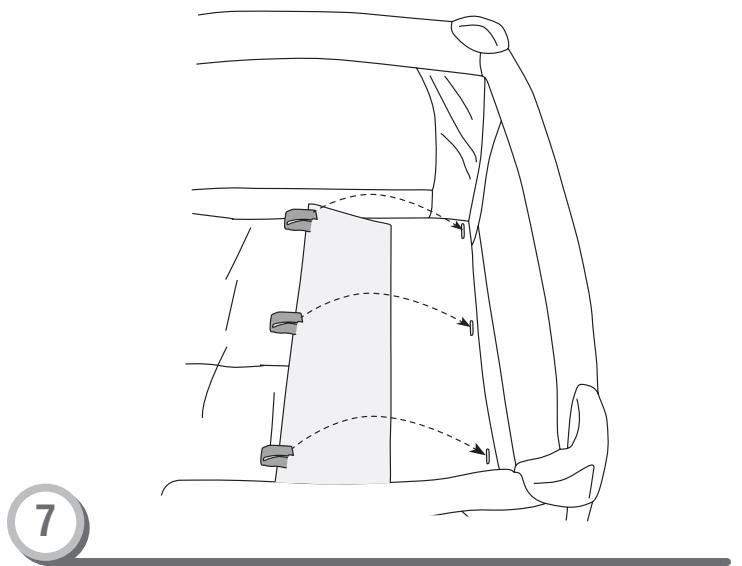

• Push down on the mattress pad to attach all hook and loop fasteners.

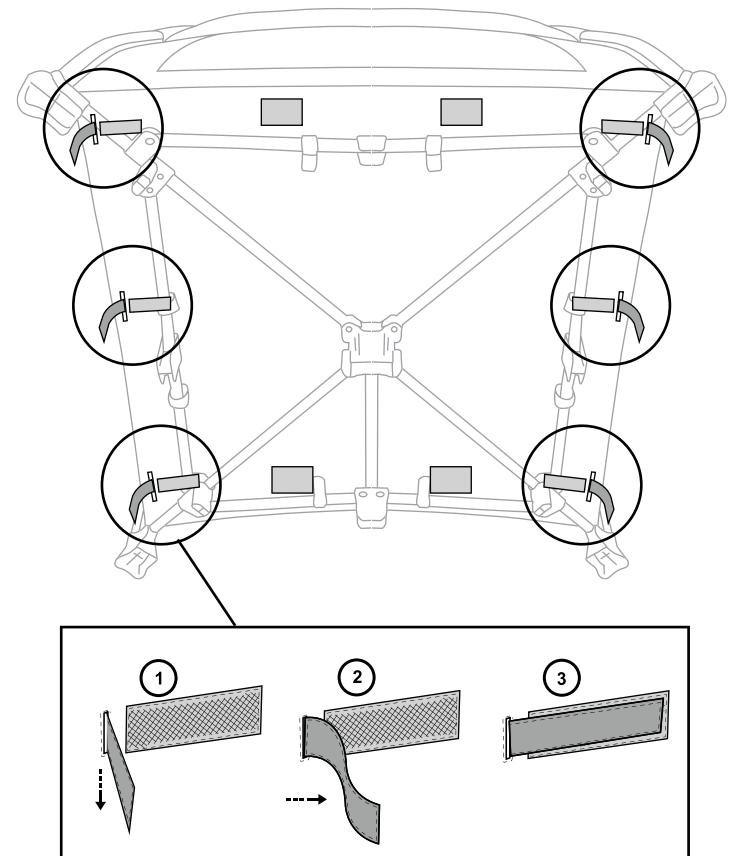

• Pull the hook and loop straps through the slots at the bottom of the play yard. Fasten straps as shown in illustration. **WARNING:** Make sure both hook and loop straps are firmly attached.

# Folding the Play Yard

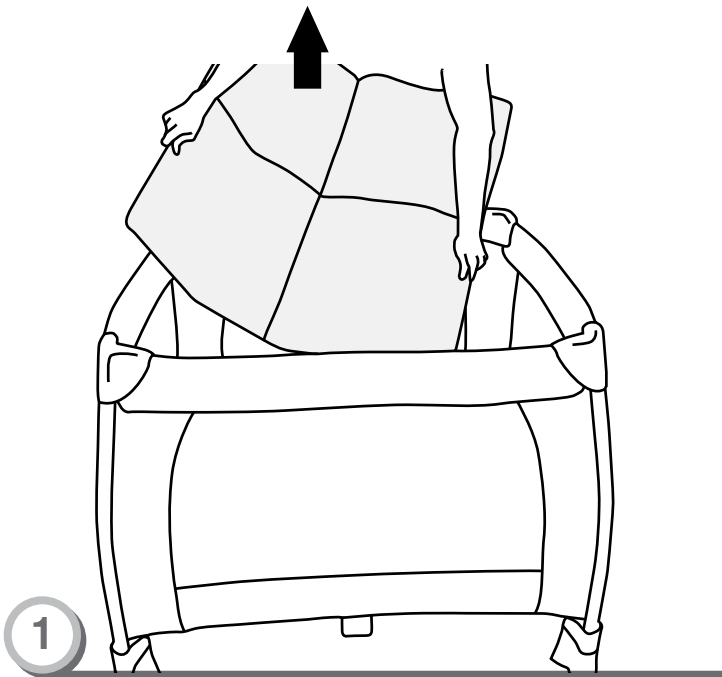

1

- Remove the mattress pad from the play yard.
- Lift to unfasten the fasteners on the underside of the mattress pad and remove.

**Note:** Remember to undo hook and loop straps from bottom of the play yard floor.

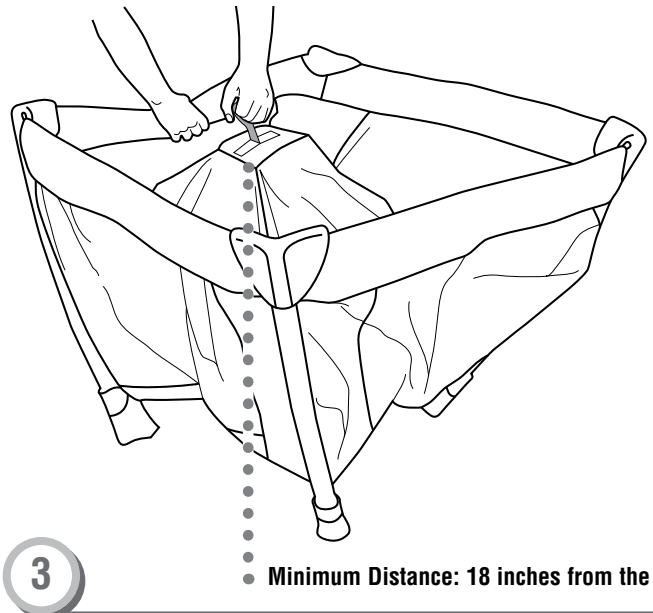

3

Minimum Distance: 18 inches from the floor

- Lift the center hub.

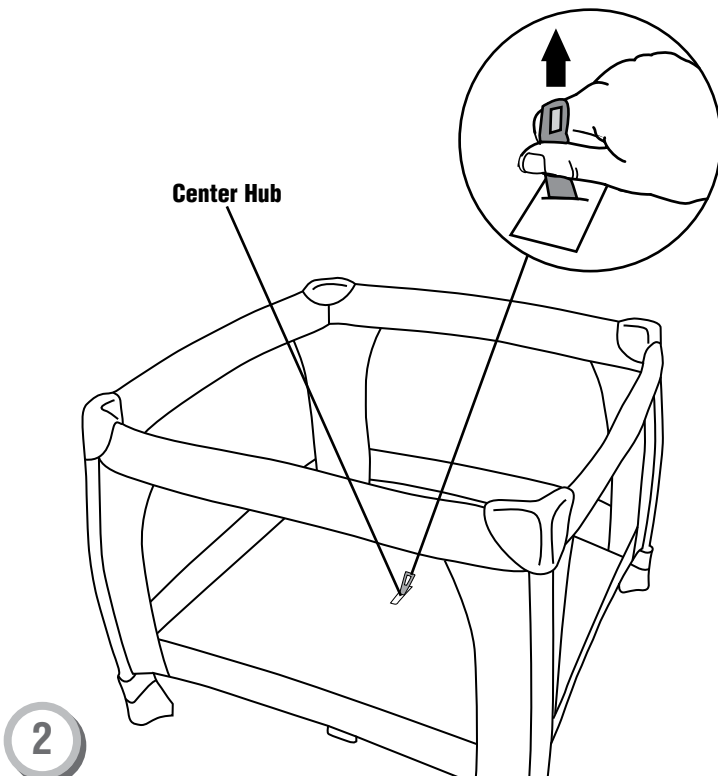

2

- Locate the center hub inside the play yard.
- Pull up on hub strap to unlock center hub.

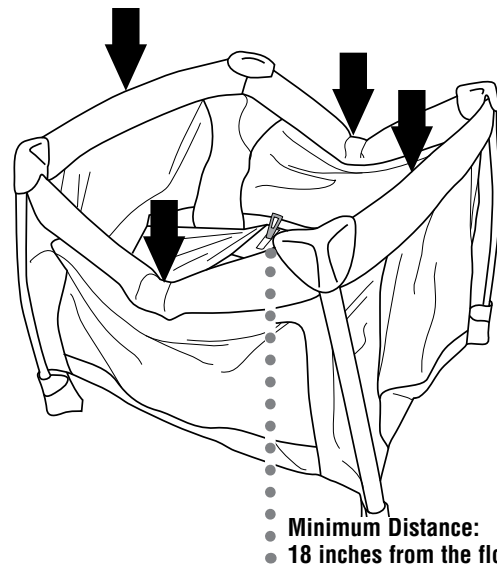

Minimum Distance:  
18 inches from the floor

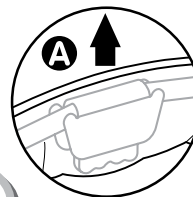

A

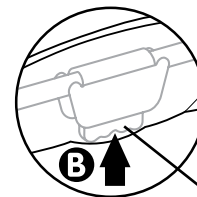

B

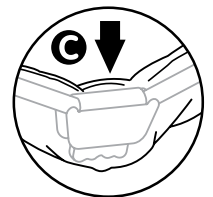

C

Button

4

- Make sure the center hub is raised at least 18 inches.
- Lift the latch **A**. Squeeze the button on the center of a side rail **B**. Gently push down **C**.
- Note:** Latches will not release unless you lift up rail center and squeeze the button at the same time.
- Repeat this procedure to release latches on the remaining three rail centers.



## Folding the Play Yard

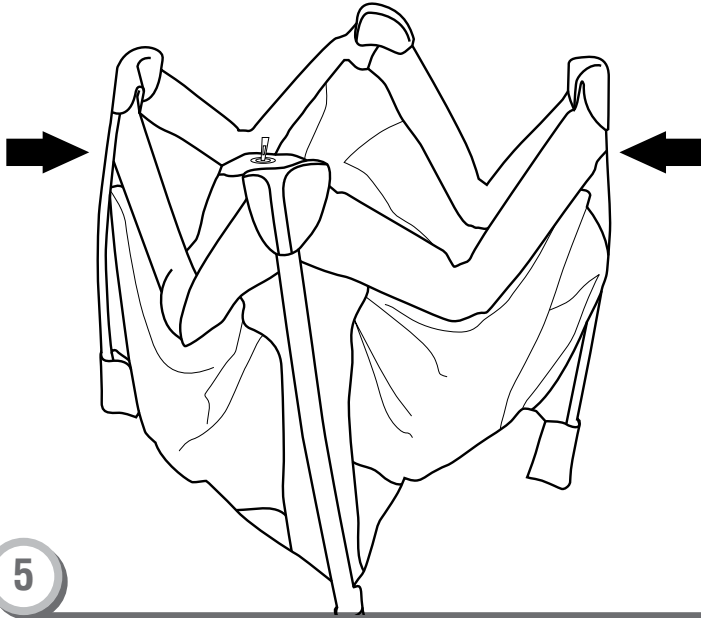

- Push all sides of play yard in toward the center hub.

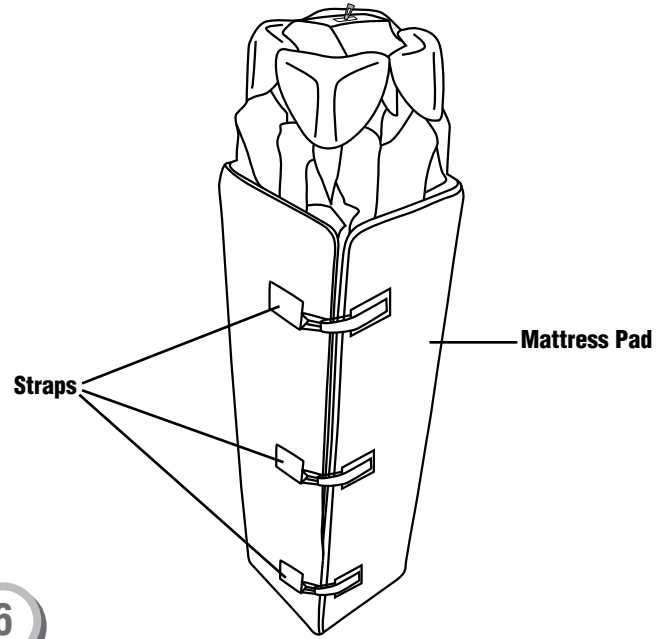

- Place the mattress pad on a flat surface with the soft side up.
- Place folded play yard on the mattress pad.
- Wrap the mattress around the play yard.
- Fasten the straps on the mattress pad.

## Storage/Travel Bag

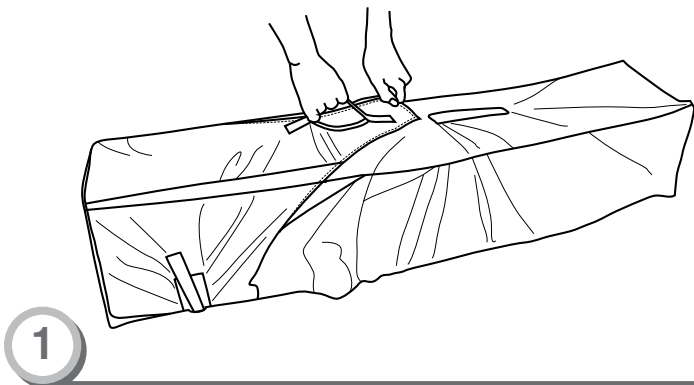

- Locate opening in storage bag. Locate carry handle on mattress. Align the opening with handle.
- Slide the folded play yard and mattress pad into the opening in the storage/travel bag.
- Close the zipper.





# DELTA♥CHILDREN

Delta Children's Products Corp.  
114 West 26<sup>th</sup> Street  
New York, NY 10001  
[gcs@DeltaChildren.com](mailto:gcs@DeltaChildren.com)  
[www.DeltaChildren.com](http://www.DeltaChildren.com)