

# DELUXE SWEET BEGINNINGS BASSINET



## INSTRUCTION MANUAL

**ADULT ASSEMBLY REQUIRED**

# 25021

**▲ WARNING:  
CHOKING HAZARD**

Adult assembly required because of small parts. Keep assembly parts out of reach of children under 3 years.

**STYLES AND COLORS MAY VARY**

**REQUIRED: 4 x AA Batteries  
(not included)  
Screwdriver  
(not included)**

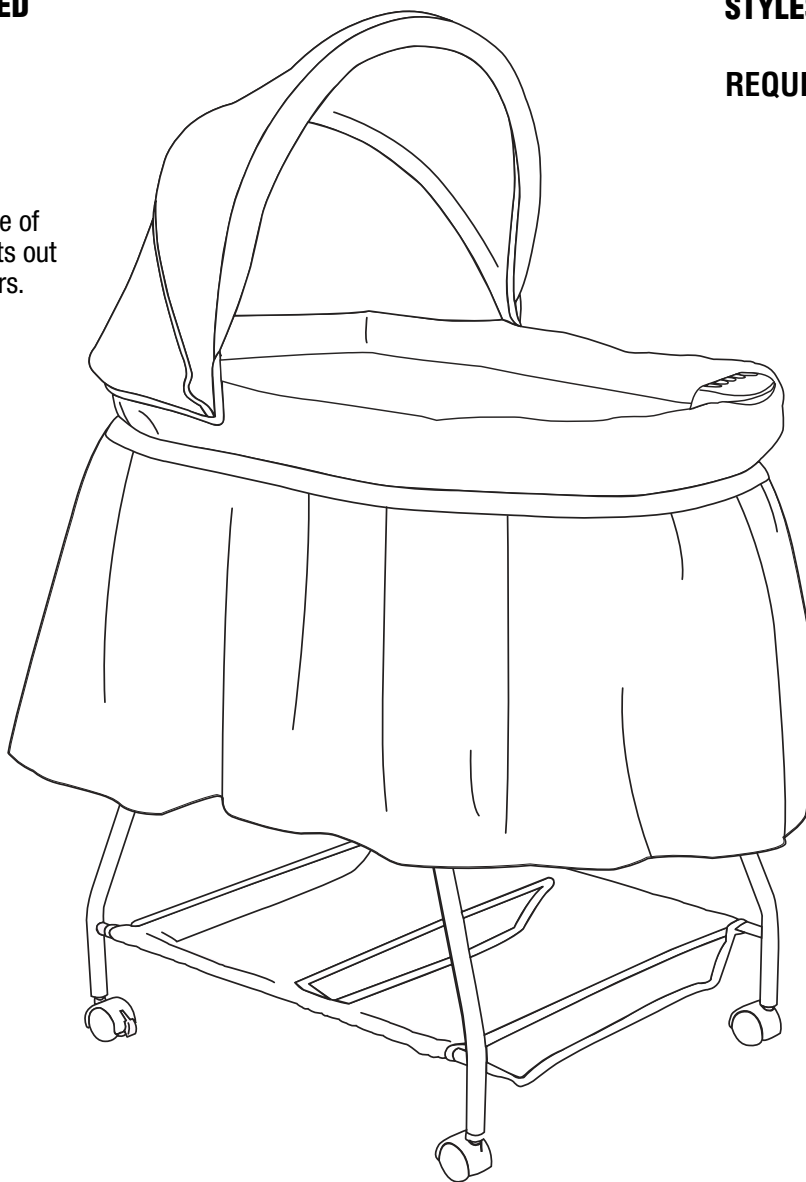

**Read all instructions BEFORE assembly and USE of product  
KEEP INSTRUCTIONS FOR FUTURE USE.**

Customer Experience Center  
email: [gcs@DeltaChildren.com](mailto:gcs@DeltaChildren.com)



[www.DeltaChildren.com](http://www.DeltaChildren.com)

DGP-IM-20200729

# Consumer Information



## WARNING

**Failure to follow these warnings and instructions could result in serious injury or death.**

- **Read all instructions before assembling unit.**

**KEEP INSTRUCTIONS FOR FUTURE USE.**

**DO NOT USE THIS UNIT IF THE INSTRUCTIONS CANNOT BE STRICTLY FOLLOWED.**

- Before each usage or assembly, inspect unit for damaged hardware, loose joints, missing parts or sharp edges. NEVER use this product if there are any loose or missing fasteners, loose joints, broken parts, or torn mesh/fabric. Check before assembly and periodically during use. Contact Delta Children's Products Customer Service Department at [gcs@DeltaChildren.com](mailto:gcs@DeltaChildren.com) for replacement parts, repair or instructions.
- **DO NOT** substitute parts.
- **FALL HAZARD**—For use from birth to 5 months or until your baby begins to push up on their hands and knees, whichever comes first.
- Use bassinet with only one child at a time.
- Strings can cause strangulation! **DO NOT** place items with a string around a child's neck, such as hood strings or pacifier cords. **DO NOT** suspend strings over a product or attach strings to toys.
- **SUFFOCATION HAZARD:** Infants can suffocate:
  - In gaps between an extra pad and side of the bassinet/criadle.
  - On soft bedding.
- Use **ONLY** the pad provided by the manufacturer. **NEVER** add a pillow, comforter or another mattress for padding.
- If a sheet is used with the pad, use only the one provided by the manufacturer or one specifically designed to fit the dimensions of the bassinet/criadle.
- To reduce the risk of SIDS, pediatricians recommend healthy infants be placed on their back to sleep, unless otherwise advised by your physician.
- Never use plastic shipping bags or other plastic film as a mattress covers not sold and intended for that purpose. They can cause suffocation.
- **DO NOT** place bassinet near a window where cords from blinds or drapes may strangle a child. Child may fall out of window.
- **DO NOT** place cords, straps or similar items that could become wound around a child's neck in or near the bassinet.

## CARE AND MAINTENANCE

- The frame, mattress pad, storage basket, music module may be wiped clean using a mild cleaning solution and a damp cloth. Do not use bleach. Do not use harsh or abrasive cleaners. Rinse clean with water to remove residue. Do not immerse the frame.
- The sheet is machine washable. Wash it separately in cold water on the gentle cycle. Do not use bleach. Tumble dry separately on low heat and remove promptly.
- Always store product in a clean and dry place.
- Before each usage or assembly, inspect unit for damaged hardware, loose joints, missing parts or sharp edges. NEVER use this product if there are any loose or missing fasteners, loose joints, broken parts, or torn mesh/fabric.



## **Before returning this product to the store! Let's see if we can assist you!**

- **Not sure how to assemble our product?**

Visit our site for easy to follow instructions along with some Tricks and Tips assembly videos <https://www.deltachildren.com/pages/instructions>

- **If you are missing a piece or have a damaged part**

Please contact our Consumer Experience Center for assistance at email [gcs@DeltaChildren.com](mailto:gcs@DeltaChildren.com).

To better assist you please have your Style# or Model# and Lot# available. This can be found on a white rectangular sticker on your product, on the registration card, and on the product's box.

- **In the event we do not have a replacement part available**

You may need to return your product to the retailer for an exchange or refund.

- **Warranty**

In order to protect your investment, don't forget to register your product.

You may also wish to consider purchasing our extended warranty.

Visit <https://www.deltachildren.com/pages/extended-warranty> for more details.

- **Please note:**

"All Final", "As Is" or Third Party/Liquidator sales are not covered under our Limited Manufacturer Warranty.

# DELTA CHILDREN

## LIMITED MANUFACTURER WARRANTY

This Delta product is warranted to be free from defects for a period of 90 days from the date of purchase under normal use. If a product is defective during this period, we will at our option repair or replace the defective part or product. This limited warranty extends only to the original retail purchaser and is valid only when supplied with proof of purchase, or if received as a gift, when the registration is on file with Delta.

This limited warranty does not cover the following:

- Products purchased as floor models or samples.
- Items purchased on an “as-is” basis, as a second hand product, or as a resale product.
- Items purchased at a Final sale, a “Going out of Business” sale, or a Liquidation sale. This limited warranty gives you specific legal rights and you may also have other rights which vary from state to state.

This limited warranty gives you specific legal rights and you may also have other rights which vary from state to state.

**TO REGISTER YOUR PRODUCT** for important safety alerts and updates to your product please visit [www.deltachildren.com](http://www.deltachildren.com)

**TO REPORT A PROBLEM**, please log on to [www.deltachildren.com](http://www.deltachildren.com) and click the Consumer Care Tab, or contact us by email at [gcs@DeltaChildren.com](mailto:gcs@DeltaChildren.com)

Date of Purchase: \_\_\_\_\_ (you should also keep your receipt)

## EXTENDED WARRANTY

### **DON'T MISS YOUR CHANCE TO BE COVERED FOR ALL OF LIFE'S MISHAPS!**

With Delta's Extended Warranty, you're covered for mechanical failure from normal use or if your item stops working due to normal wear and tear, plus all those unexpected surprises.

## **2 YEARS OF PROTECTION**

**For Additional Information:**

**Simply visit our Website, register your product, and add the Extended Warranty**

**<https://www.deltachildren.com/pages/product-registration>**

Extended Warranty only available in the following States: Arkansas, Colorado, Delaware, District of Columbia, Georgia, Idaho, Illinois, Indiana, Iowa, Kansas, Kentucky, Louisiana, Maryland, Michigan, Mississippi, Missouri, Nebraska, Nevada, New Hampshire, New York, North Carolina, North Dakota, Pennsylvania, Rhode Island, South Dakota, Tennessee, Utah, West Virginia

# Parts

**IMPORTANT!** Please remove all parts from the package and identify them before assembly.

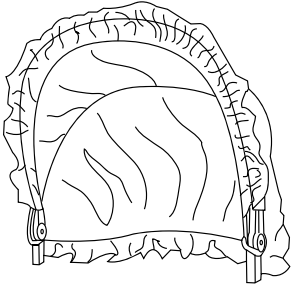

**Canopy**

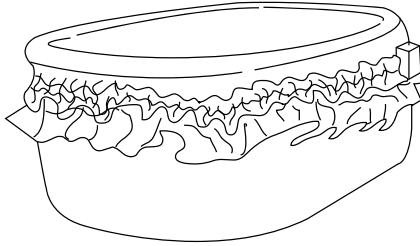

**Bassinet Fabric Cover**



**Mattress Pad**

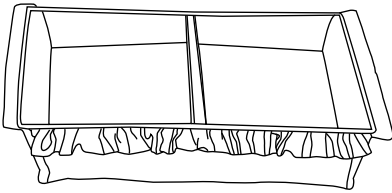

**Storage Basket**

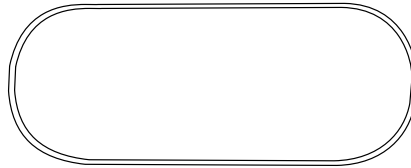

**Mattress Support**



**Top Rail Frame**

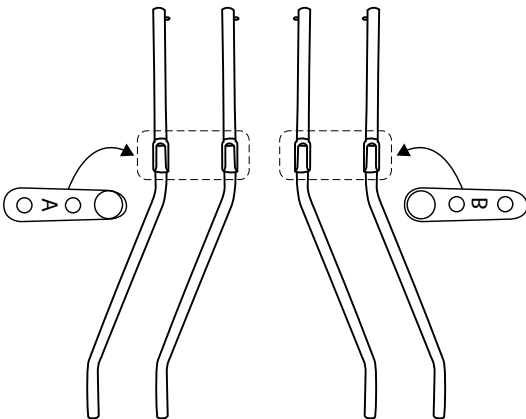

**Support Legs**  
(2 X A / 2 X B)

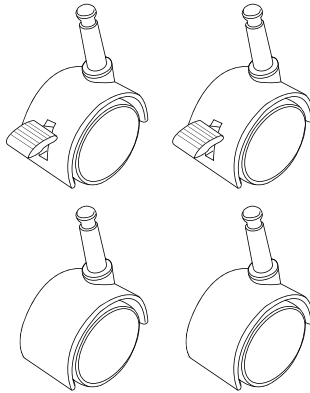

**Caster (X2)**  
**Locking Caster (X2)**

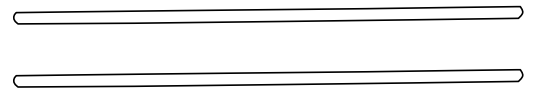

**Basket Support Tubes**

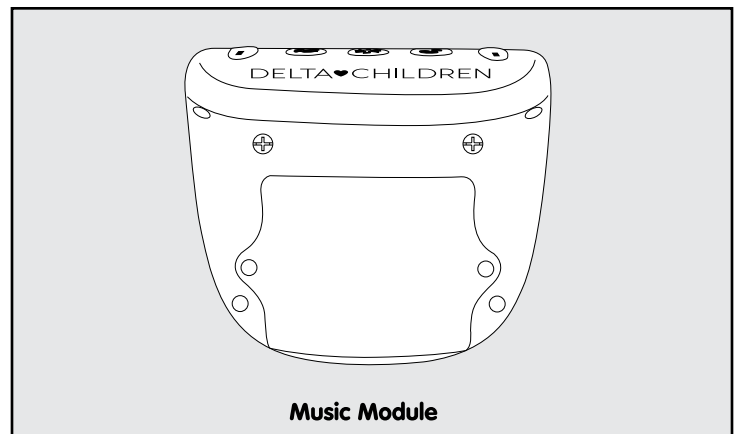
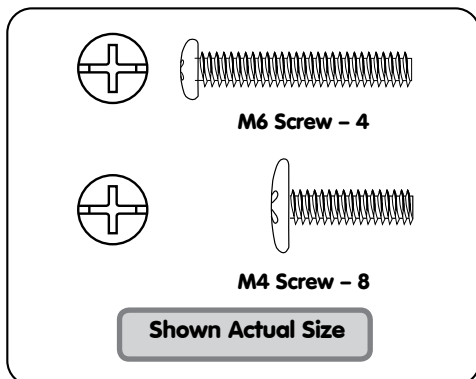

# Bassinet Assembly

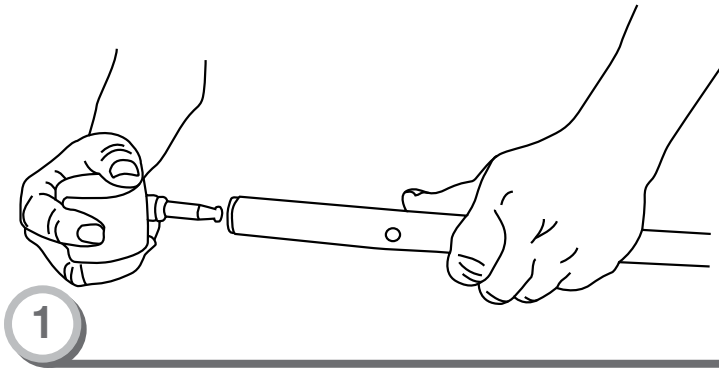

- Locate four (4) support legs and four (4) casters.
  - Insert casters into the bottom of the support leg and push caster in until you hear it “clicks” into place.
  - Pull on the caster to assure it is properly locked in place.
  - Repeat for other three (3) support legs and casters.
- NOTE:** Make sure to position the 2 locking casters at rear of bassinet.

Support Leg Insert

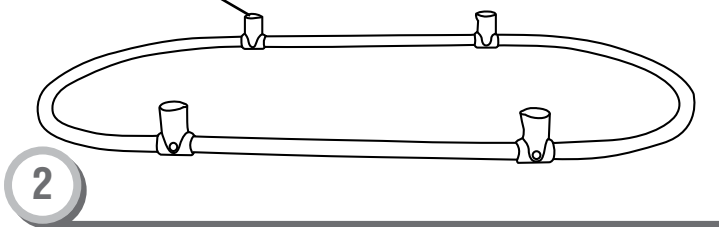

- Locate the top rail frame.
- Lay the top rail frame on the floor with the support leg inserts facing up.

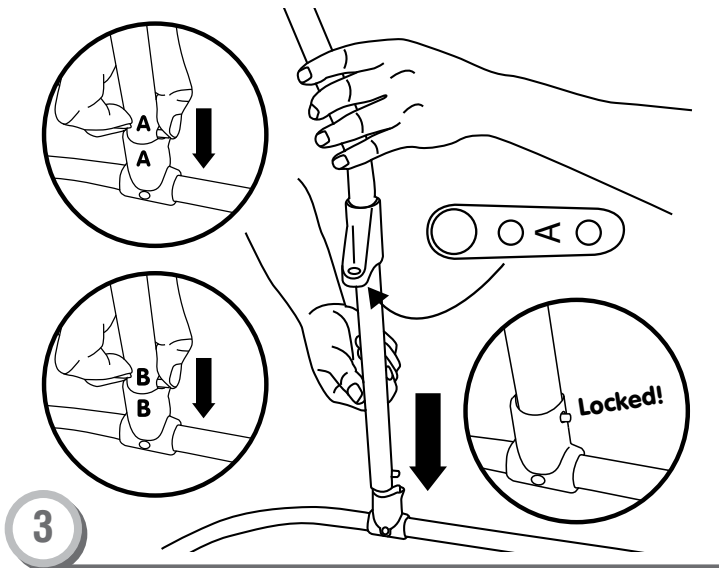

- Locate the four (4) support legs.
- Identify support legs labeled “A” and “B”.
- Align leg “A” with support leg insert “A”
- Insert the support leg into the support leg insert and push the leg down until you hear it “click” into the locked position.
- Repeat for other support leg “A” and two support legs “B”.

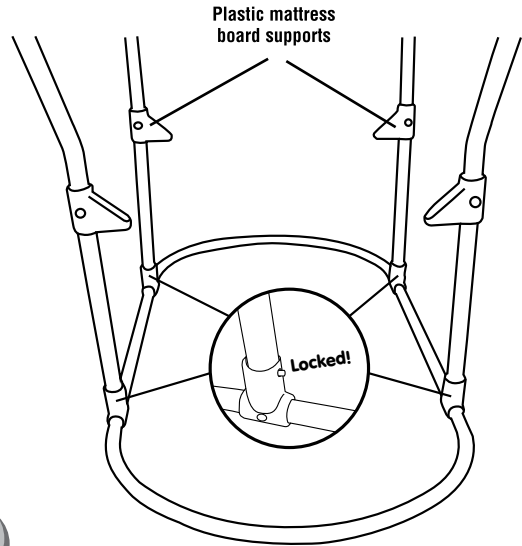

- Make sure all plastic mattress board supports are facing inward.
- Confirm that all four support legs have been properly inserted into the support leg inserts as shown above.
- Pull upon all support legs to assure they are properly locked to the top frame.

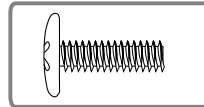

Mattress Board

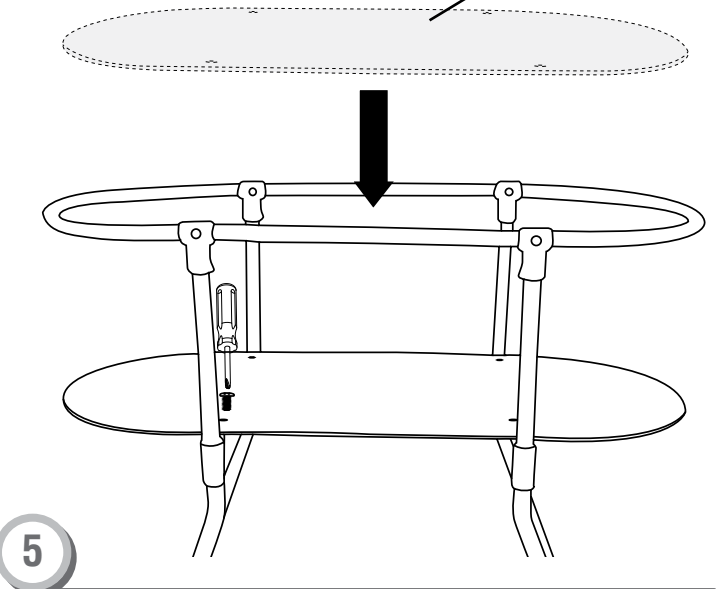

- Locate the mattress board and eight (8) M4 screws.
- Place the mattress board into the frame lining up the four through holes with the plastic mattress board support nuts.
- Using a screw driver and four (4) M4 screws, tighten the mattress board onto the plastic mattress board supports.
- Repeat this procedure for the four (4) remaining screw holes.

# Bassinet Assembly

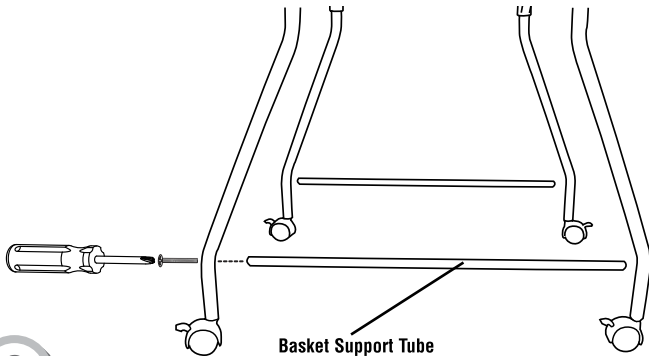
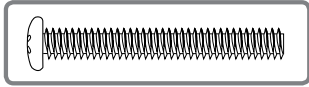

6

- Locate the two (2) basket support tubes.
- Insert and fasten only one side of the two support tubes with M6 x 4cm screws through the holes in the legs and basket support tubes.
- Repeat the same procedure for second basket support tube.

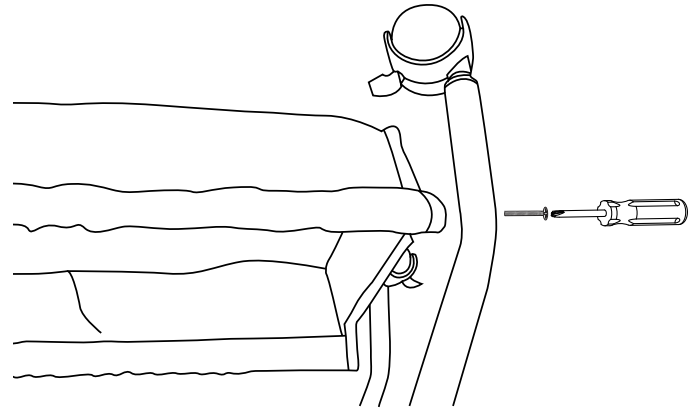

8

- Locate remaining two (2) M6 screws.
- Using the screw driver and M6 screw, tighten the screw to the basket support tube.
- Repeat this procedure for second basket support tube.

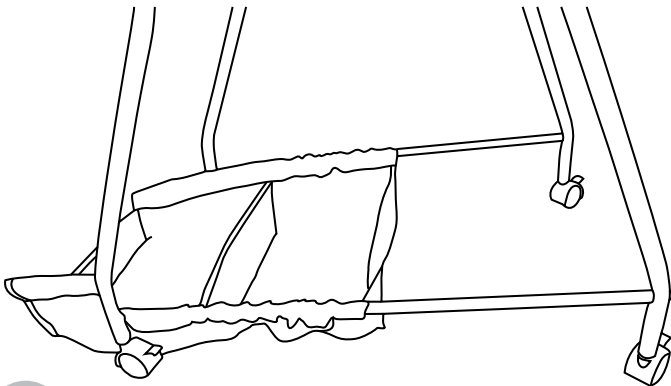

7

- Locate the storage basket.
- With the bottom of the storage basket facing up insert the basket support tubes into the storage basket sleeves.

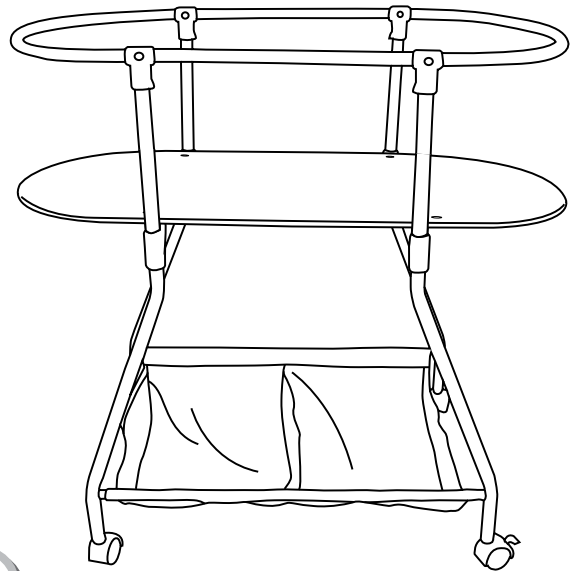

9

- Turn frame over into the up right position.

# Battery Safety Information

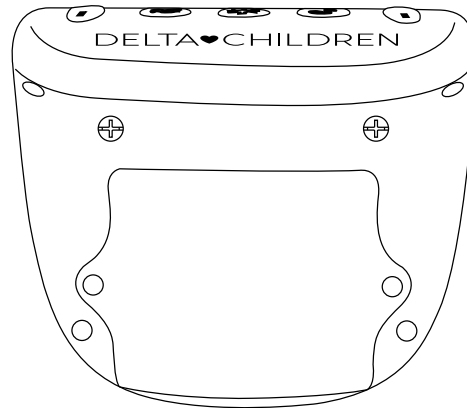

**In exceptional circumstances, batteries may leak fluids that can cause a chemical burn injury or ruin your product. To avoid battery leakage:**

- Do not mix old and new batteries or batteries of different types: alkaline, standard (carbon-zinc) or rechargeable (nickel-cadmium).
- Insert batteries as indicated inside the battery compartment.
- Remove batteries during long periods of non-use. Always remove exhausted batteries from the product. Dispose of batteries safely.
- Never short-circuit the battery terminals.
- Use only batteries of the same or equivalent type, as recommended.
- Do not charge non-rechargeable batteries.
- Remove rechargeable batteries from the product before charging.
- If removable, rechargeable batteries are used, they are only to be charged under adult supervision.
- **When discarding batteries, be sure to dispose of them in the proper manner, according to your state and local regulations.**

## Attaching Music Module

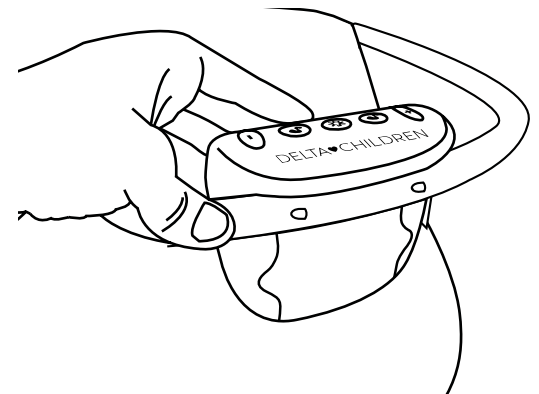
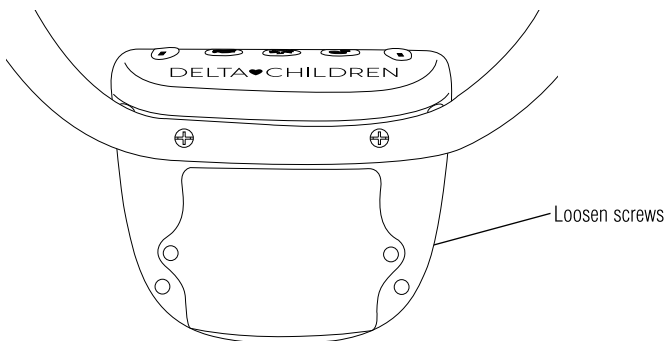

1. Locate battery Compartment on the front of music module. Loosen screw in Battery Compartment with Phillips Head screwdriver.
- Lift to remove door. Insert four (4) "AA" alkaline batteries.
- Replace door and tighten screw.

**HINT:** We recommend using alkaline batteries for longer battery life.

2. To attach Music Module, remove the screws and line up music module to screw holes on front mattress support frame.



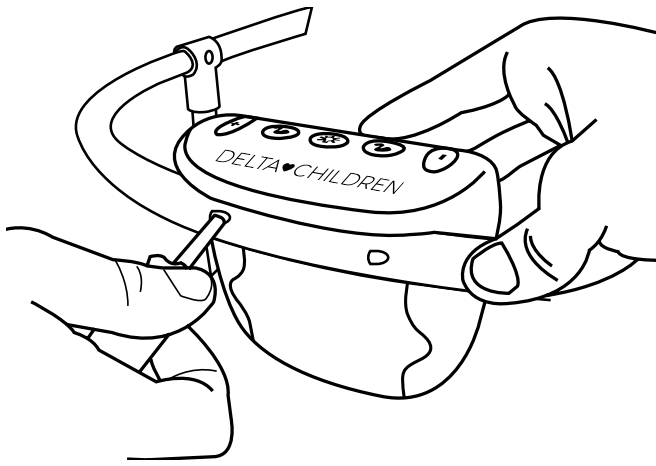

3. Position Music Module onto mattress support frame and screw module to frame.

## Music Module Operation

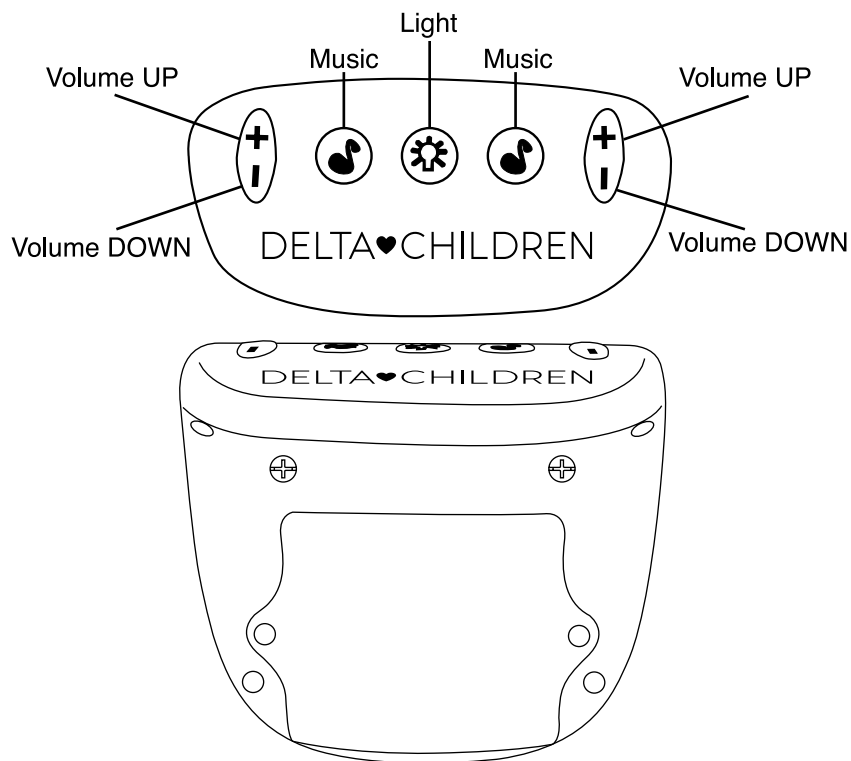

- Activate bassinet light by pressing LIGHT button  on the top of the music module.
- **NOTE:** Light will stay on in 5 minute cycles, unless button is pressed before 5 minutes are up.
- Press MUSIC button (🎵) on top of the music module to activate MUSIC. Press button multiple times to cycle through three (3) music melodies.
- Volume can be adjusted with UP/DOWN buttons on the top of the music module.

## Bassinet Assembly

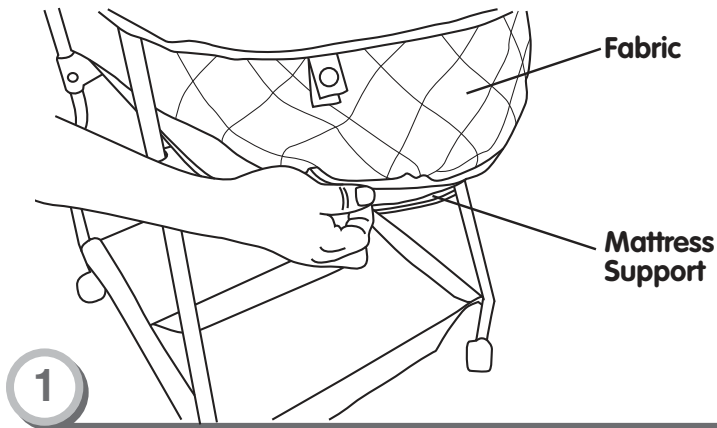

- Place the liner into frame. Make sure warning label is centered at the end of bassinet.

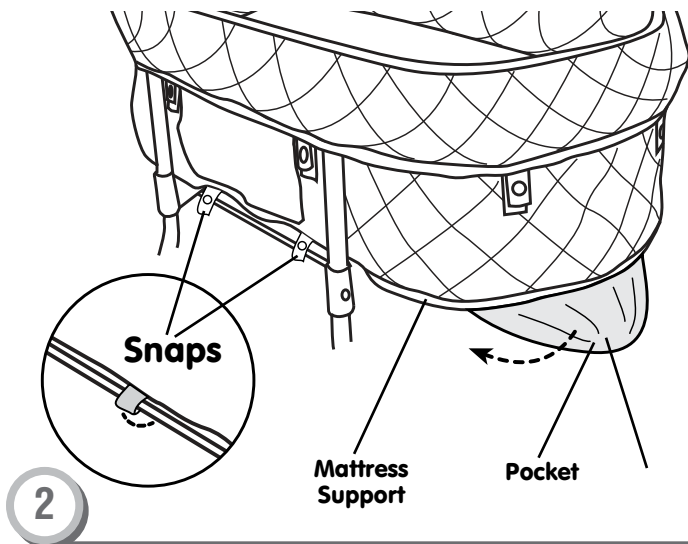

- Stretch the pockets on the bottom of the liner around the ends of the mattress support.

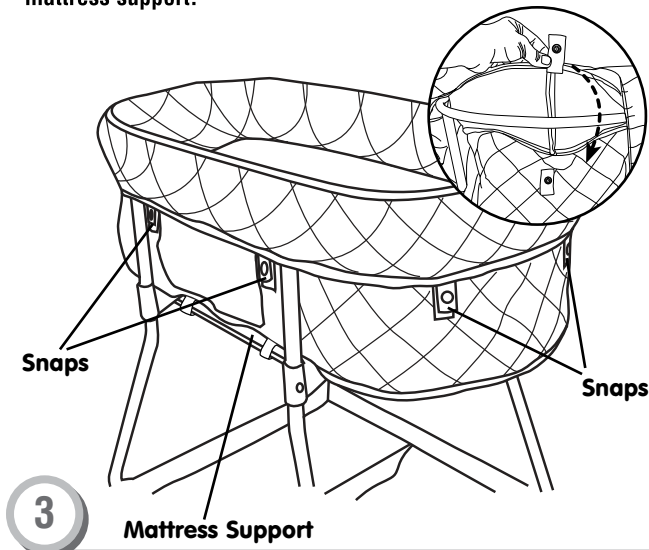

- Lift the skirt on the liner. Snap all 4 straps around the top of the side of the frame.
- Repeat this procedure to snap the other 4 straps around the top of the frame.

## Place Sheet on Mattress Pad

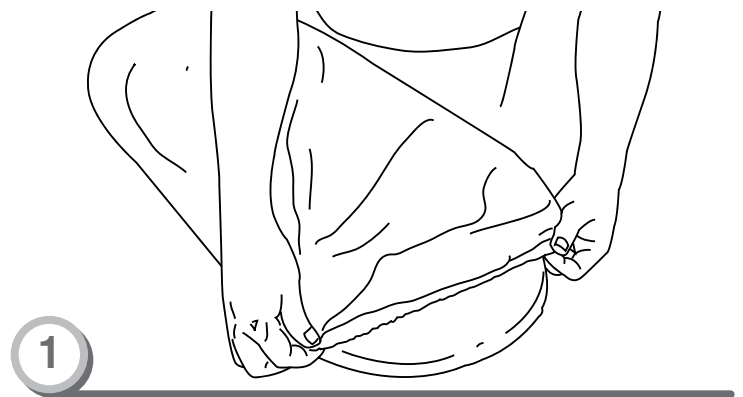

- Place the sheet over the mattress pad.

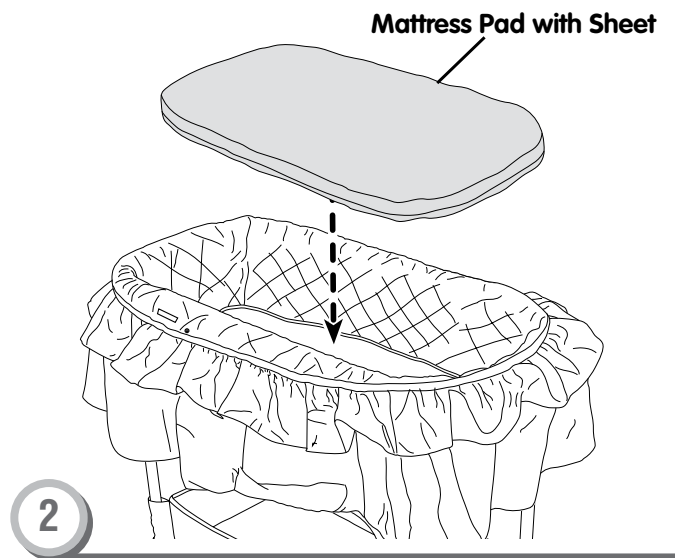

- Please place the mattress pad with sheet inside the bassinet for the safety and comfort of your baby.

# To Attach Hood

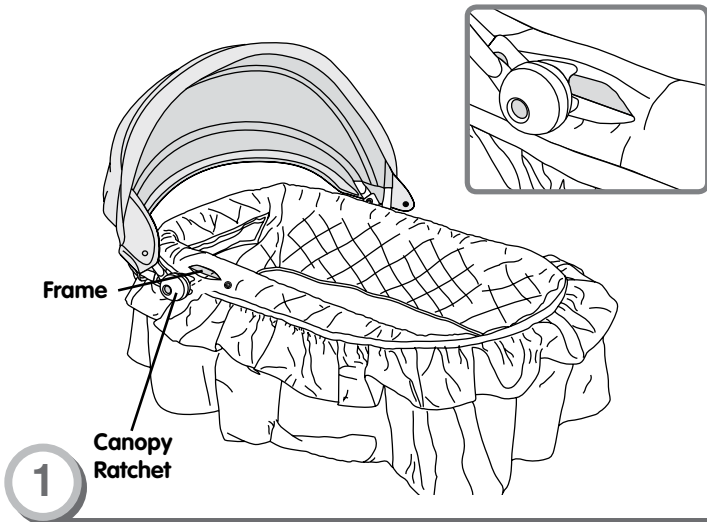

- Position the canopy over the top end of the bassinet opposite the warning label.
- Open the hole on the liner and push aside foam to expose metal.
- Push the canopy ratchet onto the frame on both sides of the bassinet.

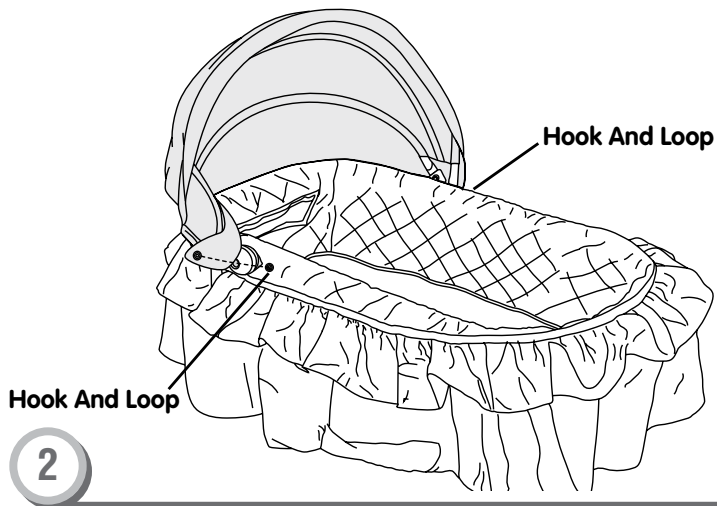

- Fasten the hook and loop on each canopy flap to the side of the bassinet liner.

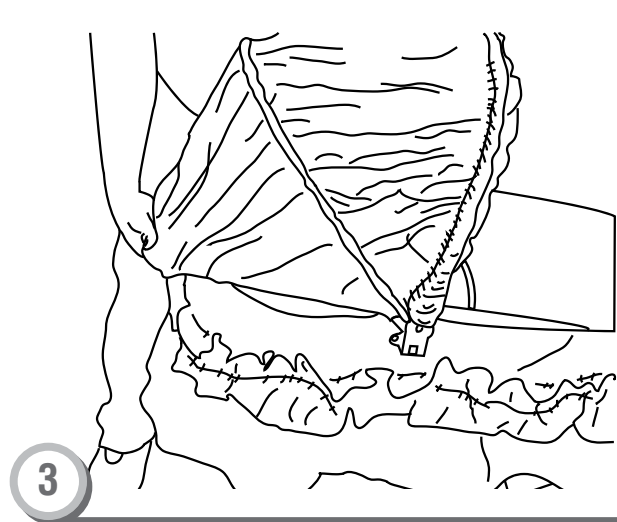

- Pull bottom back side of canopy over the bassinet top rail.

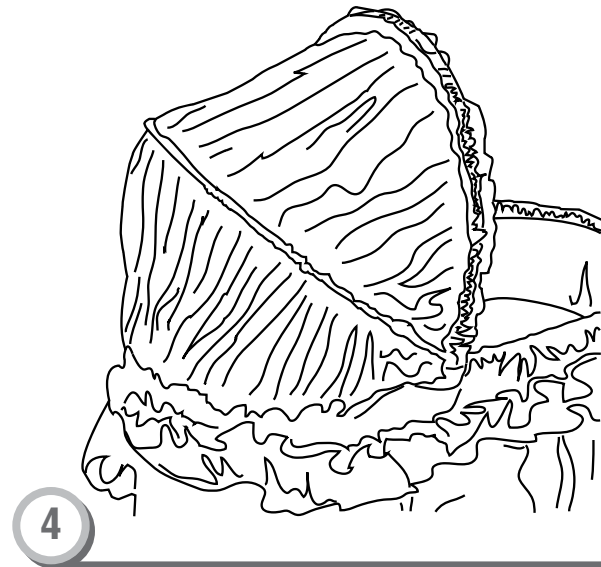

- **Hint:** For best result , make sure elastic is even across the back of the bassinet.

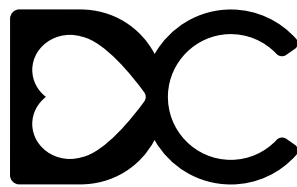

DELTACHILDREN

**Delta Children's Products Corp.**

114 West 26<sup>th</sup> Street  
New York, NY 10001  
gcs@DeltaChildren.com  
www.DeltaChildren.com