

4-IN-1 DISCOVER & PLAY MUSICAL WALKER

WALKER / ROCKER / 360 ACTIVITY CENTER / WALK-BEHIND



INSTRUCTION MANUAL

**22404/
LF22404**

ASSEMBLY INSTRUCTIONS

STYLES AND COLORS MAY VARY

REQUIRED: (x4) "AA" Batteries (not Included)
Phillips Screwdriver (not included)

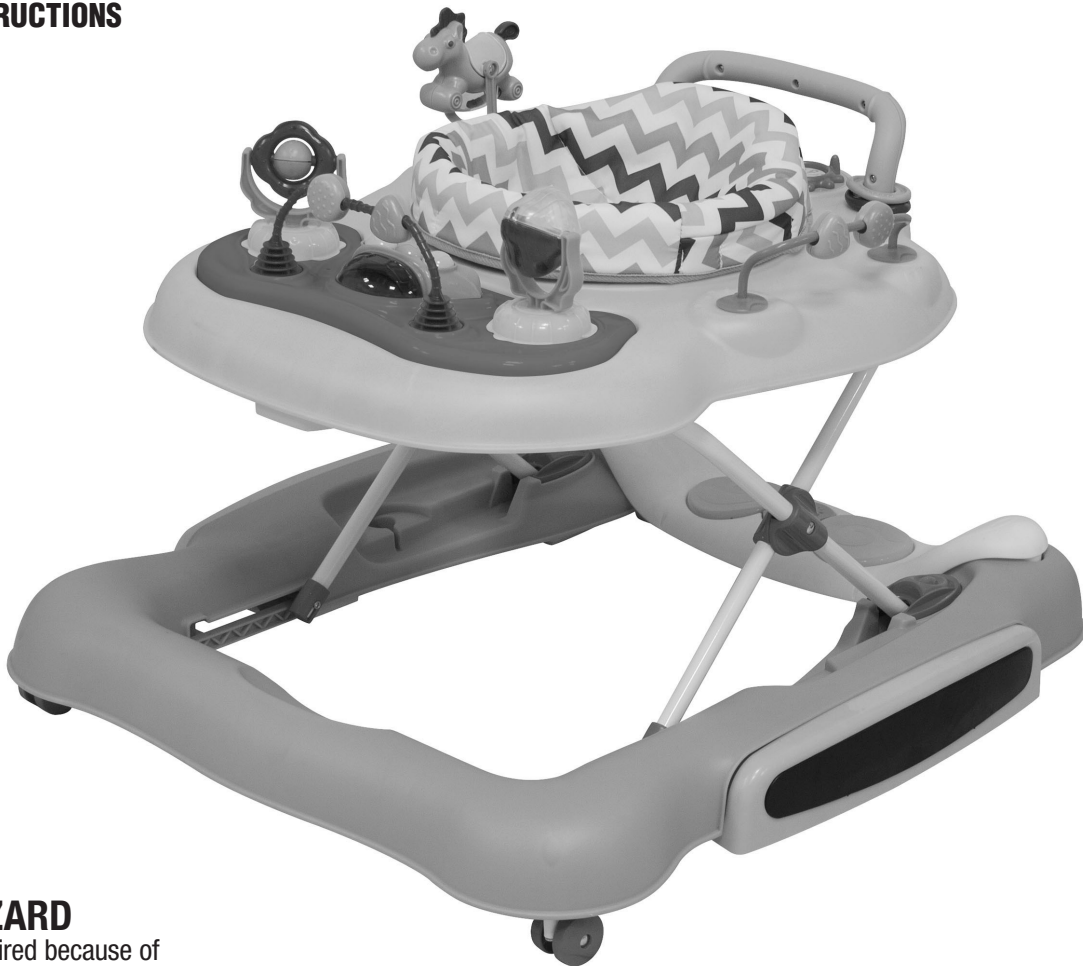

**▲ WARNING:
CHOKING HAZARD**

Adult assembly required because of small parts. Keep assembly parts out of reach of children under 3 years.

**Read all instructions BEFORE assembly and USE of product
KEEP INSTRUCTIONS FOR FUTURE USE.**

Customer Experience Center
phone: (646) 435-8726
email: gcs@DeltaChildren.com



www.DeltaChildren.com

DCP-IM-03022020-F13

! WARNING !

WARNING: Read all instructions before assembly and use of the walker/activity center (keep the instructions for future reference), incorrect assembly may make the walker/activity center unsafe. Failure to follow these warnings and the instructions could result in serious injury or death.

! WARNING !

FALL HAZARD:

- **NEVER** leave child unattended.
- **ALWAYS** keep child in view while in walker/activity center.
- **NEVER** use near stairs or thresholds.
- Babies can **FALL** from product resulting in head injuries.

STRANGULATION HAZARD:

- Strings can cause strangulation! **DO NOT** place items with a string around child's neck, such as hood strings or pacifier cords.
- **DO NOT** suspend strings over product or attach strings to toys.

- To avoid burn injuries, always keep child away from ranges, radiators, hot liquids, space heaters, fireplaces, etc.
- To avoid drowning, never use near pools, bathtubs, etc.
- **ALWAYS** check that surfaces are flat and free of objects that may cause tipping over either indoors or outdoors.
- To reduce chance of child slipping out of seat, always check that both feet of child touch floor.
- Use **ONLY** for children who can sit upright **unassisted** and weigh no more than 25 lbs.
- **NEVER** spin baby in seat, only permit baby to rotate seat.
- **AVOID SERIOUS INJURY: NEVER** carry product or adjust height with child in it.



Consumer Information



WARNING

WARNING: Read all instructions before assembly and use of the walker/activity center (keep the instructions for future reference), incorrect assembly may make the walker/activity center unsafe. Failure to follow these warnings and the instructions could result in serious injury or death.

⚠ WARNING ⚠

- Adult Assembly is required.
- **DO NOT** use walker/activity center if it is damaged or broken.
- **DO NOT** use walker/activity center until baby can sit up by itself.
- Before each use clean friction components to maintain stopping performance.
- Use only on flat surfaces free of objects that could cause the walker/activity center to tip over.
- This walker/activity center is intended for use by children who can sit up unassisted and are learning to walk.
- This walker/activity center is intended for children weighting up to 25 lbs (11.8 kg) and those that are not over 30 inches in height.
- Discontinue using this walker/activity center when your child can stand unaided or walk unassisted.
- Prevent collisions with glass in rooms, windows and furniture.
- Always lock the seat in walker/activity center function.
- To avoid serious injury never carry walker/activity center with child in seat.
- Make sure all locking devices are fully engaged before each use.
- Never allow older child to play with walker/activity center or push walker at any time when another child is in the walker/activity center seat.
- **DO NOT** add any additional toys to the walker/activity center tray, use only toys intended to be used with the walker/activity center.
- **DO NOT** alter the walker/activity center by cutting toys away.
- **DO NOT** add strings or other objects to walker/activity center as the child may become entangled in them.

CARE AND MAINTENANCE

Wash using mild soap and warm water only. Wipe plastic components dry and air dry seat cover.



Before returning this product to the store! Let's see if we can assist you!

- **Not sure how to assemble our product?**

Visit our site for easy to follow instructions along with some Tricks and Tips assembly videos <https://www.deltachildren.com/pages/instructions>

- **If you are missing a piece or have a damaged part**

Please contact our Consumer Experience Center for assistance at 646-435-8726 or email gcs@DeltaChildren.com. To better assist you please have your Style# or Model# and Lot# available. This can be found on a white rectangular sticker on your product, on the registration card, and on the product's box.

- **In the event we do not have a replacement part available**

You may need to return your product to the retailer for an exchange or refund.

- **Warranty**

In order to protect your investment, don't forget to register your product. You may also wish to consider purchasing our extended warranty.

Visit <https://www.deltachildren.com/pages/extended-warranty> for more details.

- **Please note:**

"All Final", "As Is" or Third Party/Liquidator sales are not covered under our Limited Manufacturer Warranty.

DELTA CHILDREN

LIMITED MANUFACTURER WARRANTY

This Delta product is warranted to be free from defects for a period of 90 days from the date of purchase under normal use. If a product is defective during this period, we will at our option repair or replace the defective part or product. This limited warranty extends only to the original retail purchaser and is valid only when supplied with proof of purchase, or if received as a gift, when the registration is on file with Delta.

This limited warranty does not cover the following:

- Products purchased as floor models or samples.
- Items purchased on an “as-is” basis, as a second hand product, or as a resale product.
- Items purchased at a Final sale, a “Going out of Business” sale, or a Liquidation sale. This limited warranty gives you specific legal rights and you may also have other rights which vary from state to state.

This limited warranty gives you specific legal rights and you may also have other rights which vary from state to state.

TO REGISTER YOUR PRODUCT for important safety alerts and updates to your product please visit www.deltachildren.com

TO REPORT A PROBLEM, please log on to www.deltachildren.com and click the Consumer Care Tab, or contact us by phone at (646) 435-8726

Date of Purchase: _____ (you should also keep your receipt)

EXTENDED WARRANTY

DON'T MISS YOUR CHANCE TO BE COVERED FOR ALL OF LIFE'S MISHAPS!

With Delta's Extended Warranty, you're covered for mechanical failure from normal use or if your item stops working due to normal wear and tear, plus all those unexpected surprises.

2 YEARS OF PROTECTION

For Additional Information:

Simply visit our Website, register your product, and add the Extended Warranty

<https://www.deltachildren.com/pages/product-registration>

Extended Warranty only available in the following States: Arkansas, Colorado, Delaware, District of Columbia, Georgia, Idaho, Illinois, Indiana, Iowa, Kansas, Kentucky, Louisiana, Maryland, Michigan, Mississippi, Missouri, Nebraska, Nevada, New Hampshire, New York, North Carolina, North Dakota, Pennsylvania, Rhode Island, South Dakota, Tennessee, Utah, West Virginia

Parts

IMPORTANT! Please remove all parts from the package and identify them before assembly.

NOTE: Toys vary by style

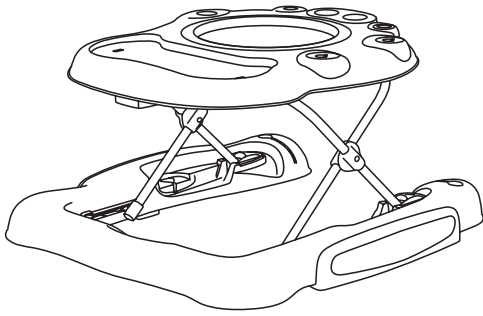

Walker Frame

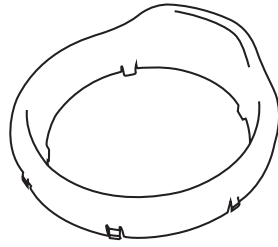

Seat Ring

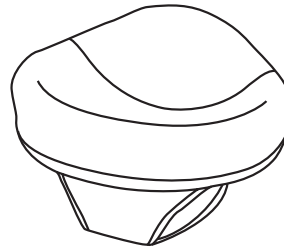

Seat Pad

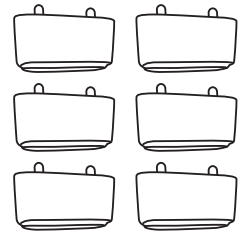

Stoppers (x6)

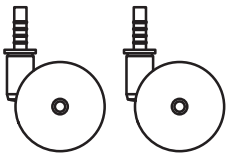

Front Wheels (x2)

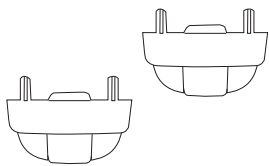

Rear Wheels (x2)

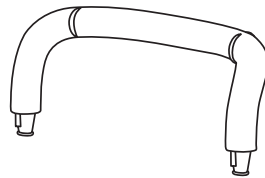

Push Behind Handle

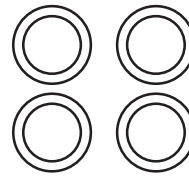

Toy Rings (x4)

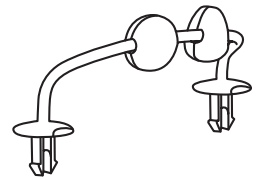

Side Toy Arch

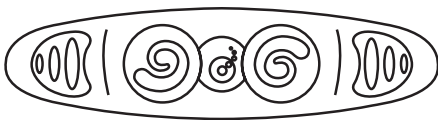

Foot Toy

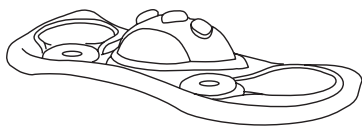

Toy Tray



Toy Gear Seat

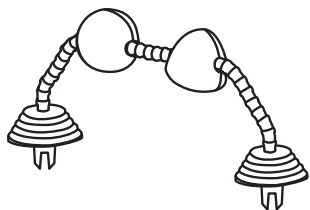

**Toy Tray Arch
(for toy tray)**

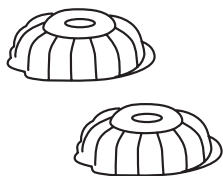

Rotating Base (x2)

TOY HORSE OR PLANT (x1)

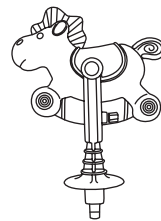

OR



TOY 1 (x1)

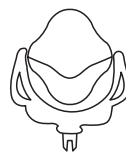

OR



OR



TOY 2 (x1)



OR

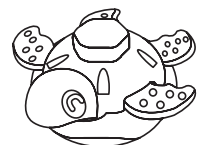

ASSEMBLY



FRONT WHEEL



REAR WHEEL



STOPPER

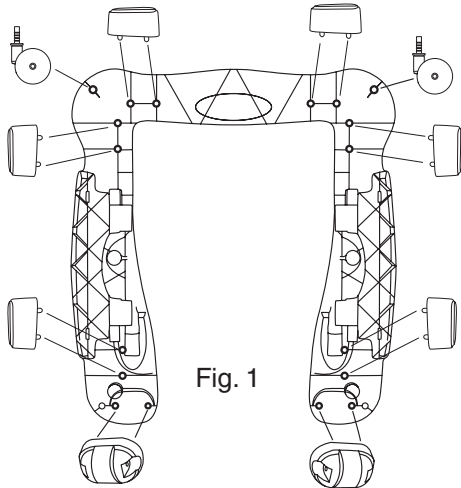

Fig. 1

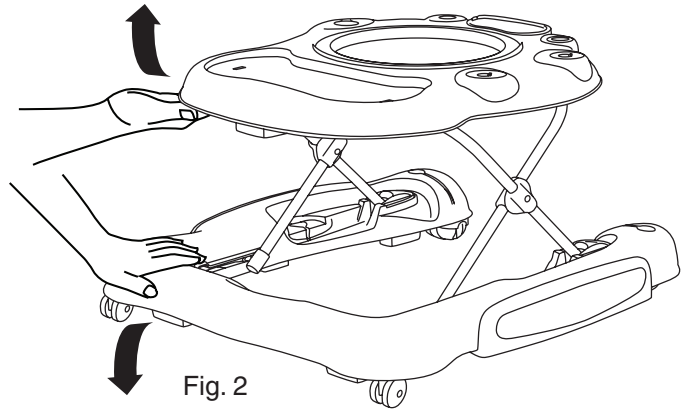

Fig. 2

1

ASSEMBLING WHEELS & STOPPERS

- Locate **front wheels** (x2), **rear wheels** (x2), and **stoppers** (x2).
- Place the walker on a solid flat surface with the bottom facing upwards.
- Insert the pins of the front wheels into their housings as shown until they click into position (Fig. 1).
- Insert the rear wheels into their housings as shown until they click into place (Fig. 1).
- Insert the stoppers into their housings as shown until they click into place (Fig. 1).
- Pull upward on all wheels/stoppers to assure they are properly inserted.

WARNING: Children should not play inside the activity center without Foot installed.

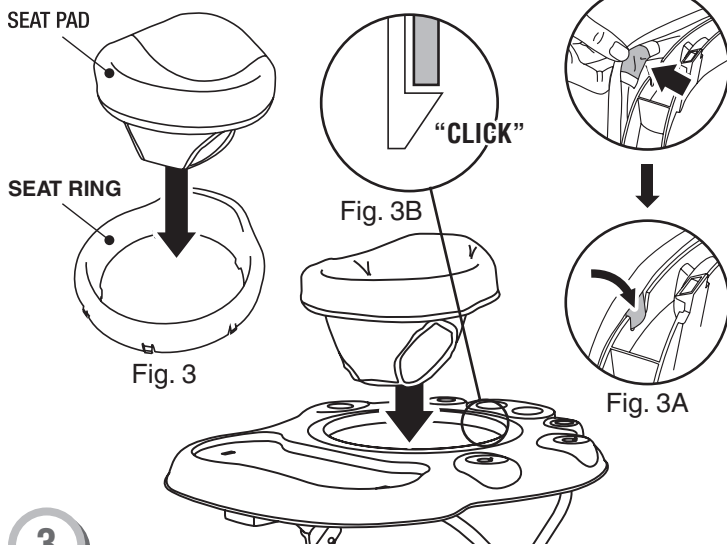

Fig. 3

Fig. 3B

Fig. 3A

3

ASSEMBLING SEAT RING

- Assemble the seat pad over the seat ring (Fig. 3).
- Hook the fabric pockets over seat ring tabs (Fig. 3A).
- Place assembled seat ring onto upper tray of walker frame until it "CLICKS" into place (Fig. 3B)

2

UNFOLDING WALKER

- Turn over the walker base.
- To raise the walker, hold the base with one hand while lifting up the top tray with the other (Fig. 2).

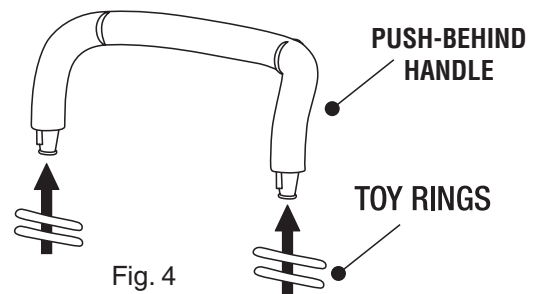

Fig. 4

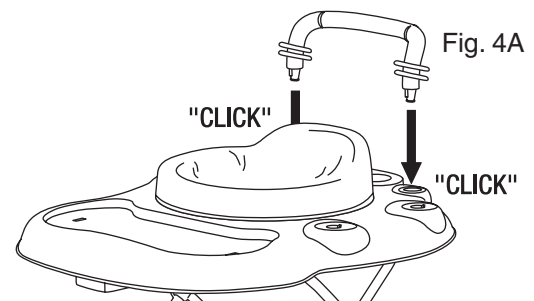

Fig. 4A

4

INSTALLING THE PUSH BEHIND HANDLE

- Place all four Toy Rings onto the Push Behind Handle as shown (Fig. 4).
- Insert Push Behind Handle into back of walker frame until it "CLICKS" into place (Fig. 4A).

ASSEMBLY

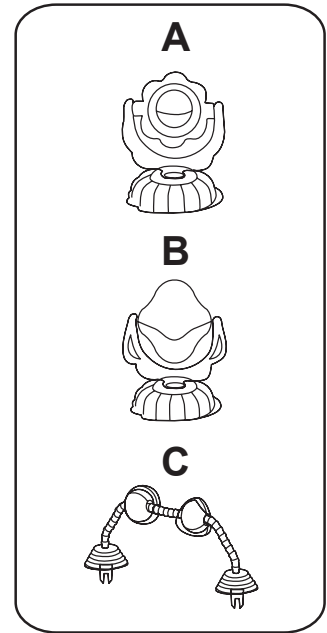
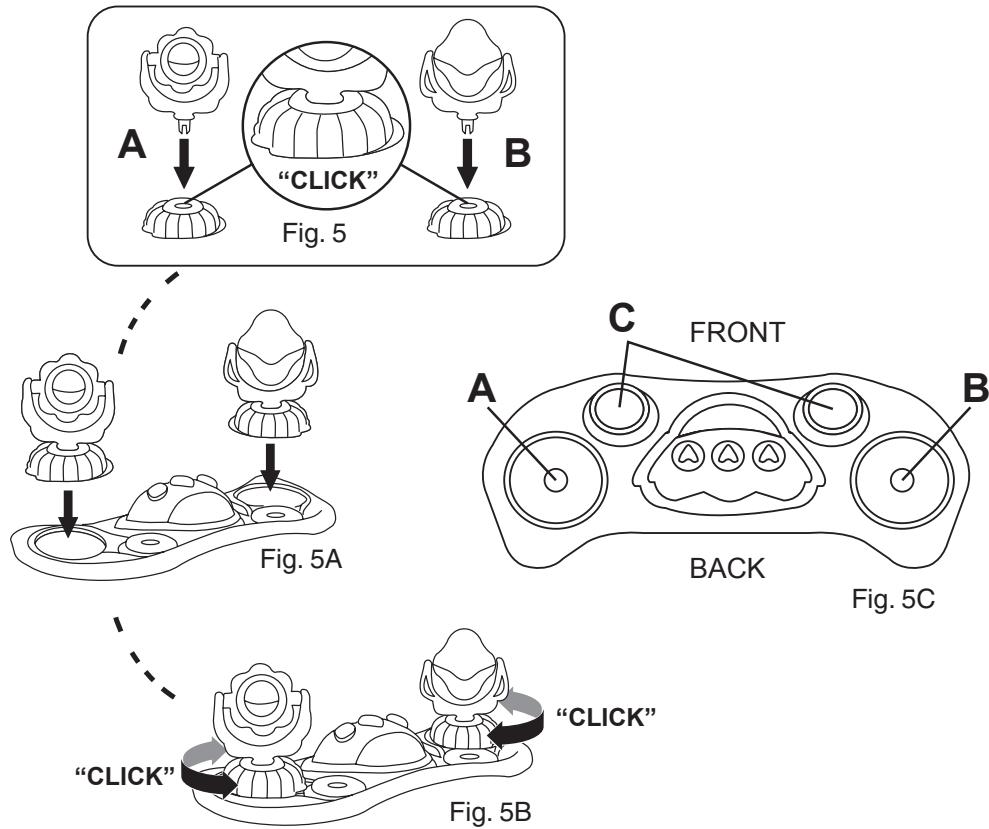

NOTE: Toys may differ from picture depending on style

5

ASSEMBLING TOYS ON TOY TRAY

- Insert toys "A" and "B" onto Rotating Base until they "CLICK" into place (Fig. 5).
- Insert 2x assembled Rotating Base onto Toy Tray (Fig. 5A).
- Secure 2x Rotating Base to Toy Tray by twisting clockwise (Fig. 5B).
- Attach Toy Tray Arch (toy "C") to sockets on Toy Tray as shown (Fig. 5C).

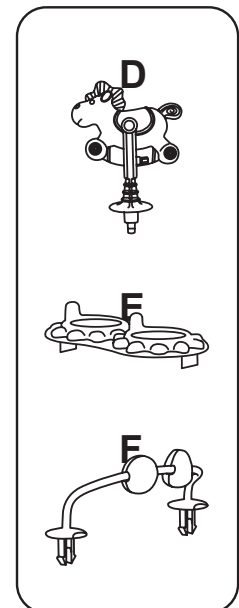
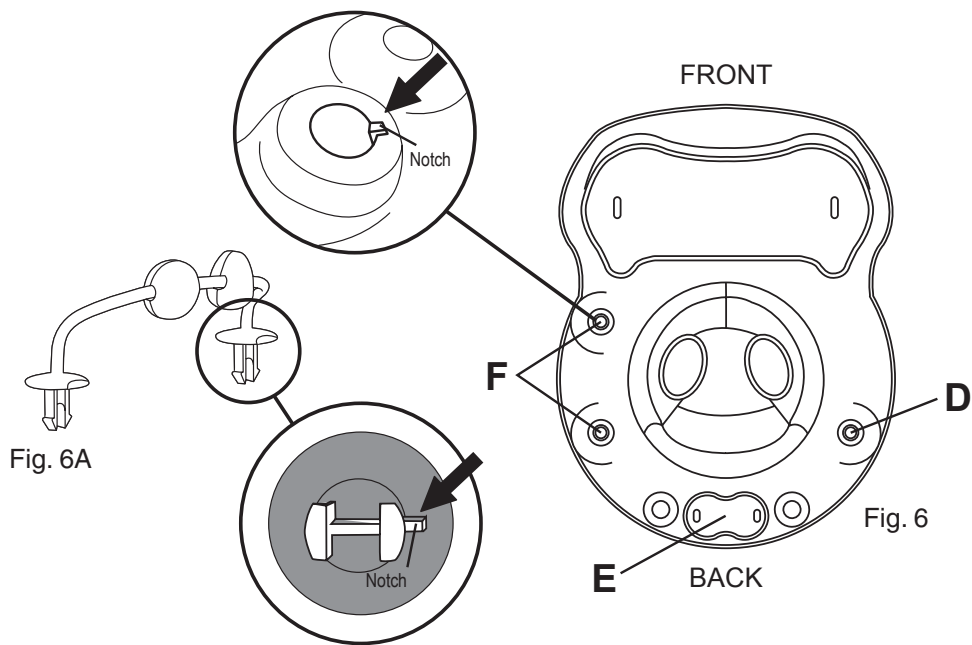

NOTE: Toys may differ from picture depending on style

6

ASSEMBLING TOYS ON WALKER BODY

- Insert toys "D" and "E" into sockets as shown until they "CLICK" into place (Fig. 6).
- Attach Toy "F" sockets on walker body, making sure to line up notch on toy with notch on walker body (Fig. 6A).

BATTERY SAFETY INFORMATION

In exceptional circumstances, batteries may leak fluids that can cause a chemical burn injury or ruin your product. To avoid battery leakage:

- Do not mix old and new batteries or batteries of different types: alkaline, standard (carbon zinc) or rechargeable (nickel-cadmium).
- Insert batteries as indicated inside battery compartment.
- Remove batteries during long periods of non-use. Always remove exhausted batteries from the product. Dispose of batteries safely. Do not dispose of product in a fire. The batteries inside may explode or leak.

- Never short-circuit the battery terminals.
- Use only batteries of the same or equivalent type as recommended.
- Do not charge non-rechargeable batteries.
- Remove rechargeable batteries from the product before charging.
- If removable, rechargeable batteries are used, they are only to be charged under adult supervision.
- When discarding batteries, be sure to dispose of them in the proper manner, according to your state and local regulations.

INSERTING BATTERIES

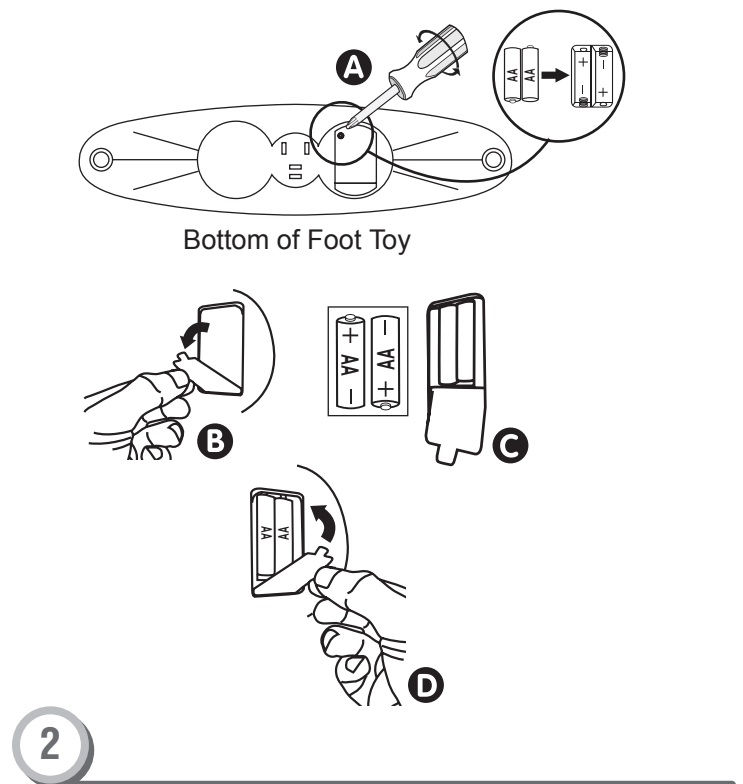
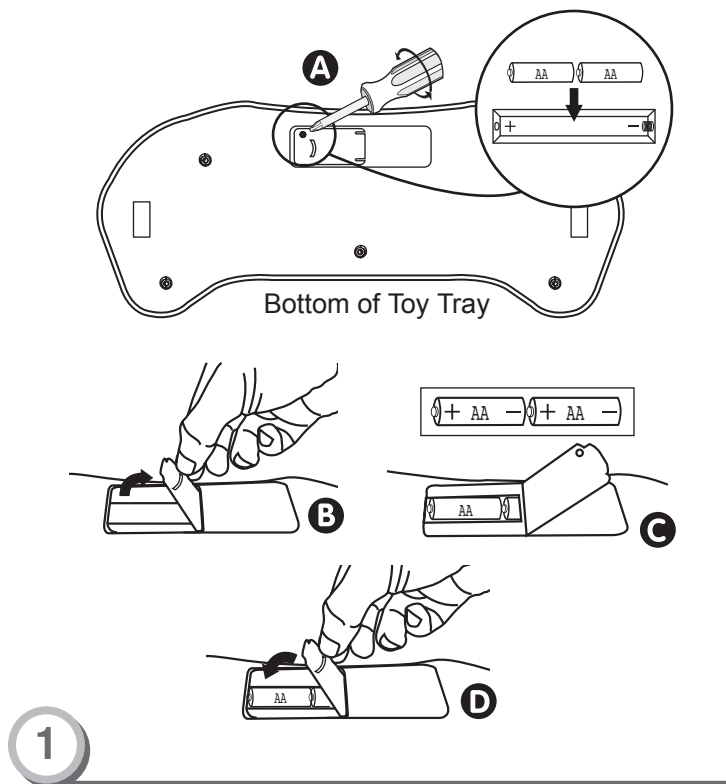

1 INSERTING BATTERIES (TOY TRAY)

- Locate the toy tray.
- Use a Phillips head screw driver to **A** unfasten the battery cover.
- **B** Lift cover to open battery compartment.
- **C** Insert AA batteries (x2) as shown in the picture.
- **D** Close battery cover. Use a Phillips head screw driver to fasten the battery cover closed.

2 INSERTING BATTERIES (FOOT TOY)

- Locate the Foot Toy.
- Use a Phillips head screw driver to **A** unfasten the battery cover.
- **B** Lift cover to open battery compartment.
- **C** Insert AA batteries (x2) as shown in the picture.
- **D** Close battery cover. Use a Phillips head screw driver to fasten the battery cover closed.

SETUP & USE

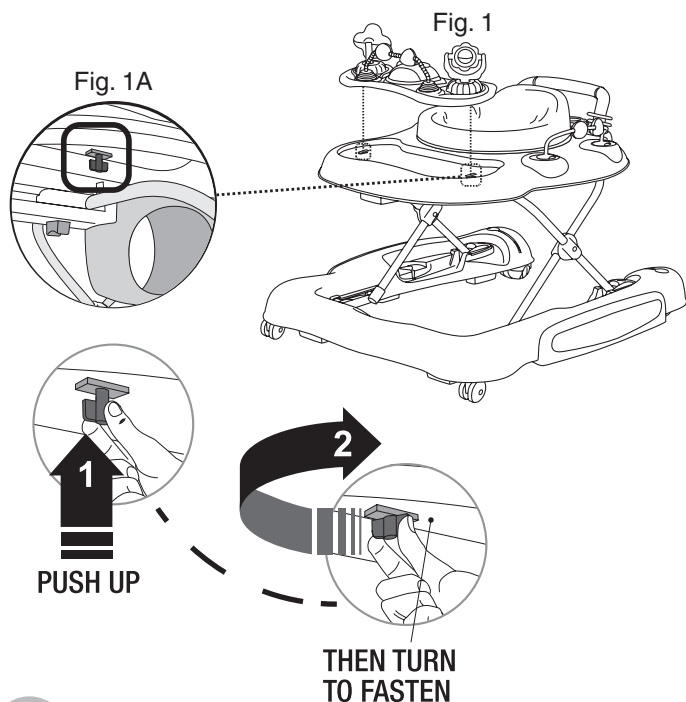

1

INSTALLING ASSEMBLED TOY TRAY SET

- On the bottom of the toy tray locate the lock slots and lock tabs on top tray.
- Align toy tray to top tray insert. While holding down the toy tray **1** push up the top tray lock tabs and **2** turn to fasten.

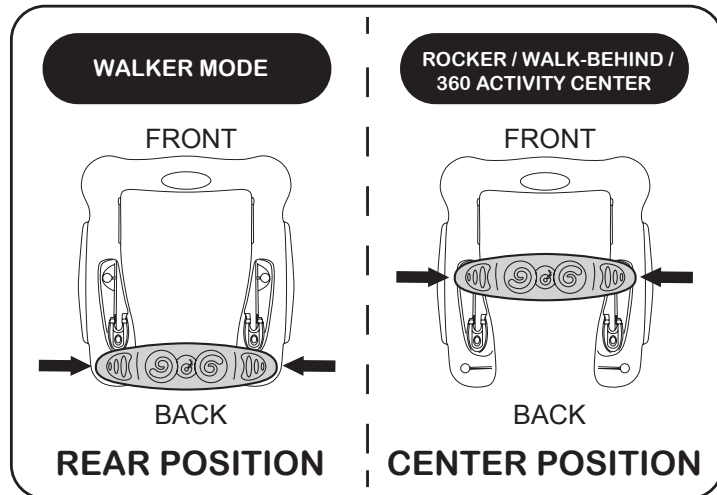

2

INSTALLING FOOT TOY

- **To install foot toy**, place in sockets as shown depending on preferred configuration. For **walker mode**, foot toy should be placed in rear sockets (Fig. 2). For **rocker, walk-behind and 360 activity center modes**, foot toy should be placed in center sockets (Fig. 2A). **NOTE:** Musical Foot Toy can only be used when baby is facing front.

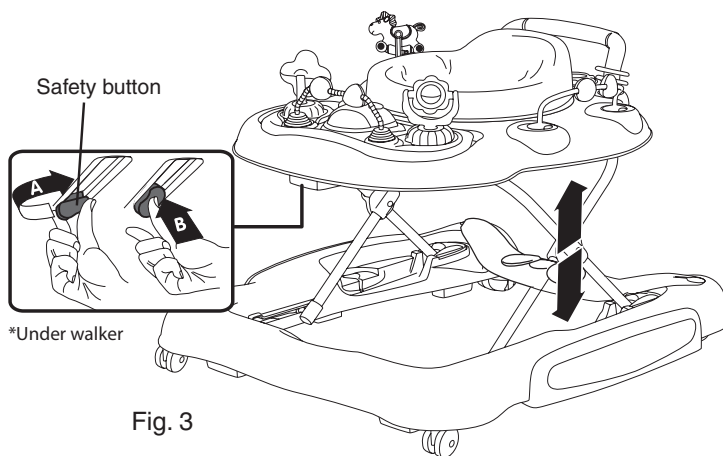

3

ADJUSTING HEIGHT & FOLDING

- Turn the safety button **A** lengthwise and press the button until the mechanism is released. With the button still pressed in, select new height. 3 different height positions are available.
- When the new position has been selected, **B** release the button and check it has turned 90 degrees back to original position.

- When folding the walker, turn to unlock as shown (Fig. 3), push the button to release and hold the button down as shown in step **B**. Carefully lower the walker into complete folded position.

WARNING: DO NOT adjust the seat height with the baby in the walker. Remove the baby from the walker when adjusting the seat height.

SETUP & USE

WARNING: DO NOT change functions with the baby in the walker. Remove the baby from the walker when changing functions.

NOTE: Musical Foot Foy can only be used when baby is facing front.

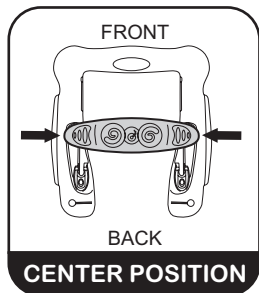

Fig. 4

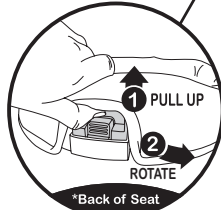
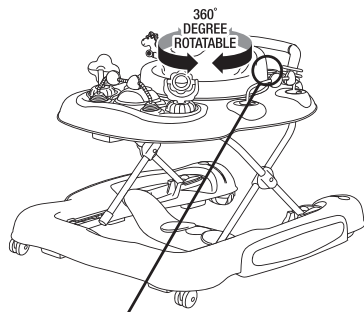

Fig. 4A

4

360° ACTIVITY CENTER MODE

- Install foot toy at **CENTER POSITION** of walker base. (Fig. 4)
- **Seat Unlocked Position:** Locate the rotation lock at the back of the seat frame and then pull up on the rotate button to enable rotation (Fig. 4A)
- **CAUTION:** Foot Toy must be installed while using in 360° activity center mode.
- **WARNING: DO NOT** spin baby in seat, only permit baby to rotate the seat.

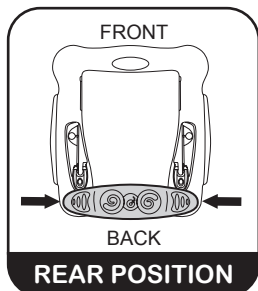

Fig. 6

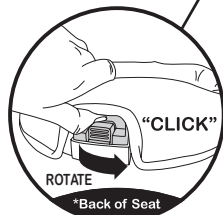
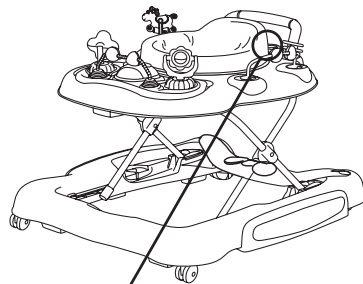

Fig. 6A

6

WALKER MODE

- Install foot toy at **REAR POSITION** of walker base. (Fig. 6)
- **Seat Locked Position:** Push rotation lock button and return to original forward facing position. Button will “CLICK” in place and rotation will be disabled (Fig. 6A).
- **CAUTION:** Foot Toy must be installed while using in activity center mode.
- **WARNING: DO NOT** spin baby in seat, only permit baby to rotate the seat.
- **IMPORTANT!** Always lock the seat rotation in walker function.

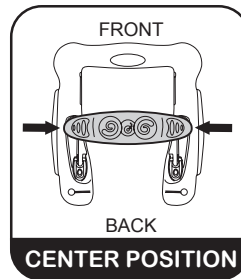

Fig. 5

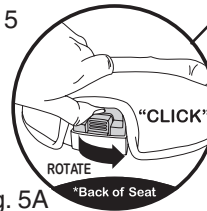
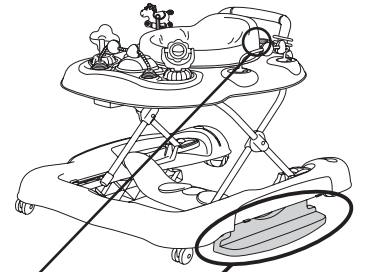

Fig. 5A

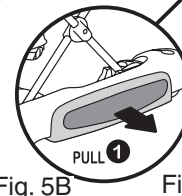

Fig. 5B

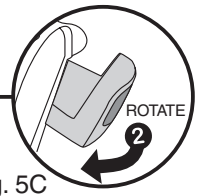

Fig. 5C

5

ROCKER MODE

- Install foot toy at **CENTER POSITION** of walker base (Fig. 5)
- **Seat Locked Position:** Push rotation lock button and return to original forward facing position. Button will “CLICK” in place and rotation will be disabled (Fig. 5A).
- Pull out rocker pads on both sides of walker frame (Fig. 5B)
- Rotate rocker pads down and push up into frame until tray “CLICKS” into place. (Fig. 5C)
- **CAUTION:** Foot Toy must be installed while using in activity center mode.
- **WARNING: DO NOT** spin baby in seat, only permit baby to rotate the seat.

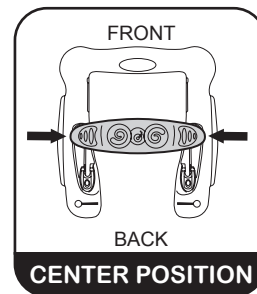
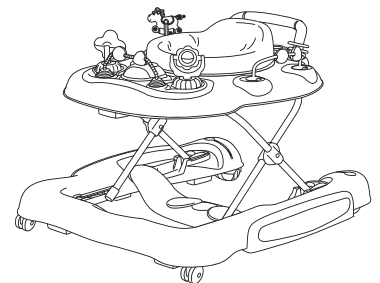

Fig. 7



7

WALK-BEHIND MODE

- Install foot toy at **CENTER POSITION** of walker base. (Fig. 7)
- **CAUTION:** Foot Toy must be installed while using in activity center mode.

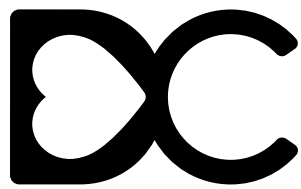

DELTACHILDREN

Delta Children's Products Corp.

114 West 26th Street
New York, NY 10001
646-435-8726
www.DeltaChildren.com