

# CROSS COUNTRY SPORT PLUS JOGGING STROLLER



J is for Jeep<sup>®</sup>  
Brand

## INSTRUCTION MANUAL

# 12988

STYLES AND COLORS MAY VARY

Fits Graco<sup>®</sup> SnugRide<sup>®</sup> Click Connect<sup>™</sup> Infant Car Seat (not included)  
Fits Evenflo<sup>®</sup> Embrace<sup>™</sup> Select Infant Car Seat (not included)  
Fits Evenflo<sup>®</sup> Nurture<sup>™</sup> Infant Car Seat (not included)  
Fits Chicco<sup>®</sup> Keyfit 30<sup>™</sup> Infant Car Seat (not included)  
Fits Britax<sup>®</sup> B-Safe 35<sup>™</sup> Infant Car Seat (not included)



### **⚠ WARNING: CHOKING HAZARD**

Adult assembly required because of small parts. Keep assembly parts out of reach of children under 3 years.

**Read all instructions BEFORE assembly and USE of product. KEEP INSTRUCTIONS FOR FUTURE USE.**

This stroller is not from, sponsored or endorsed by Graco Children's Products Inc.  
This stroller is not from, sponsored or endorsed by Evenflo Company, Inc.  
This stroller is not from, sponsored or endorsed by Artsana S.p.A.  
Copyright © Britax. All rights reserved.

Customer Service: 1-(800)-377-3777

www.DeltaChildren.com  
DCP-IM-02282018

## **WARNING**

**WARNING:** Please follow all of these instructions to ensure the safety of your child. Keep these instructions for future reference.

**WARNING:** Failure to follow these instructions could result in serious injury or death.

**WARNING:** Avoid serious injury from falling or sliding out. Always insure that the child is properly positioned by using the safety harness according to these instructions.

**WARNING:** Never leave children unattended.

**WARNING:** FALL HAZARD from tip over. Before running, jogging, or walking fast, LOCK the front wheel from swiveling.

**CAUTION:** This is a single occupant jogging stroller for one child only. The use of more than one child may cause an unstable condition which can injure your child. Do not place parcels, diaper bags or accessory items on jogging stroller as this can cause an unstable condition.

- The maximum weight that can be carried in the lower basket, child tray, parent fabric tray and carry all parent organizer each is 3 lbs (1.36 kg).
- Before allowing the children near the stroller, be certain the stroller is fully erect and latched in the open locked position.
- Use of the stroller with children weighing more than 50 pounds (22.62 kg) or over 42 inches (106.7 cm) tall, may cause a hazardous unstable condition to the stroller.
- **NEVER** use the stroller on stairways.
- **NEVER** use the stroller in conjunction with bicycles, skateboards, roller skates, or in-line skates. Please discuss using the jogging stroller with your health care provider prior to jogging use. We recommend that the child occupant needs to be 6 months of age, at the minimum, before use of the stroller.

## **CARE AND MAINTENANCE**

- To clean the stroller use a mild household soap with warm water on a sponge or clean cloth.
- Check your stroller for loose screws, worn parts, torn material or stitching on a regular basis. Replace or repair parts as needed.
- Discontinue use of stroller if it should become damaged or malfunctions. Please contact our customer service number 1-800-377-3777 to arrange for repair or obtain replacement parts.
- If you experience any difficulty with assembly, missing parts or use, please DO NOT return this item to the store. Retail stores are unable to properly assist you. Contact our Customer Service Department directly for assistance 1-800-377-3777.



## EXTENDED WARRANTY

**DON'T MISS YOUR CHANCE TO BE COVERED FOR ALL OF LIFE'S MISHAPS!**

With Delta's Extended Warranty, you're covered for mechanical failure from normal use or if your item stops working due to normal wear and tear, plus all those unexpected surprises.

## 2 YEARS OF PROTECTION

**For Additional Information:**

**Simply visit our Website, register your product, and add the Extended Warranty**

**<https://www.deltachildren.com/pages/product-registration>**

Extended Warranty only available in the following States: Arkansas, Colorado, Delaware, District of Columbia, Georgia, Idaho, Illinois, Indiana, Iowa, Kansas, Kentucky, Louisiana, Maryland, Michigan, Mississippi, Missouri, Nebraska, Nevada, New Hampshire, New York, North Carolina, North Dakota, Pennsylvania, Rhode Island, South Dakota, Tennessee, Utah, West Virginia



**Please DO NOT return this product to the store.**

If you experience any difficulty with assembly, missing parts or use, please **DO NOT** return this item to the store. Retail stores are unable to properly assist you. Contact our Customer Service Department directly for assistance 1-800-377-3777.



[www.DeltaChildren.com](http://www.DeltaChildren.com) • [CustomerService@DeltaEnterprise.com](mailto:CustomerService@DeltaEnterprise.com)

©2018 Delta Children's Products, Inc. New York, NY 10001

# PARTS

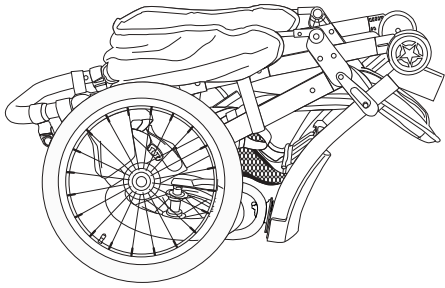

Stroller



Front Wheel Axel Lock Nuts

Part # 50218



Front Wheel Retainer Plate

Part # 50219

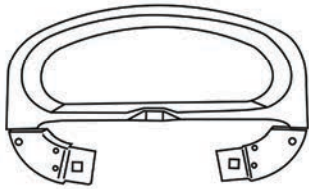

Child Tray

Part # 50174

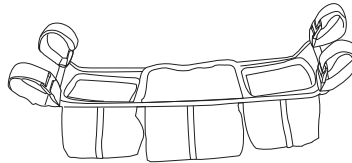

Parent Fabric Tray

Part # 50229

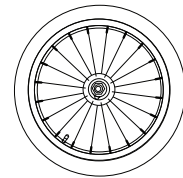

Front Wheel

Part # 50171



Carry All Parent Organizer

Part # 50217

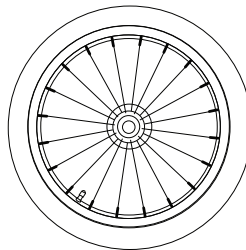

Rear Wheels

Part # 50172

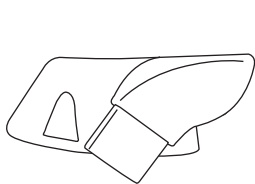
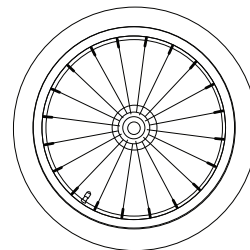

Right Side View

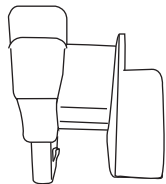

Right Side Front View-When Facing The Stroller

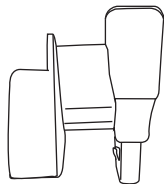

Left Side Front View-When Facing The Stroller

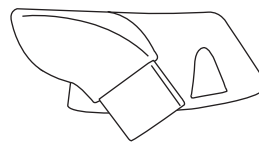

Left Side View



Right Side Front View



Left Side Front View

Chicco Car Seat Adapters

Part # 50232

Britax Car Seat Adapters

Part # 50231

# ASSEMBLY

**IMPORTANT!** To ensure safe operation of your stroller, please follow these instructions carefully. Please keep these instructions for future reference.

**IMPORTANT!** Before assembly and each use, inspect this product for damaged hardware, loose joints, missing parts or sharp edges. NEVER use stroller if any parts are missing or broken. **IMPORTANT!** Adult assembly is required.

- Remove stroller from box. The front wheel, rear wheels, parent tray and child tray need to be installed prior to use.

## FRONT WHEEL

**WARNING:** This front wheel utilizes a front wheel axle lock nut system. Please follow all of these instructions to ensure the safety of your child. Failure to follow these instructions could result in serious injury or death.

- To attach the front wheel, unfold stroller as described in the following section:

- .....
1. Lean the stroller backwards so the rear axle frame is resting on a flat surface and the front wheel forks are pointing upward (Fig. 1).
- .....

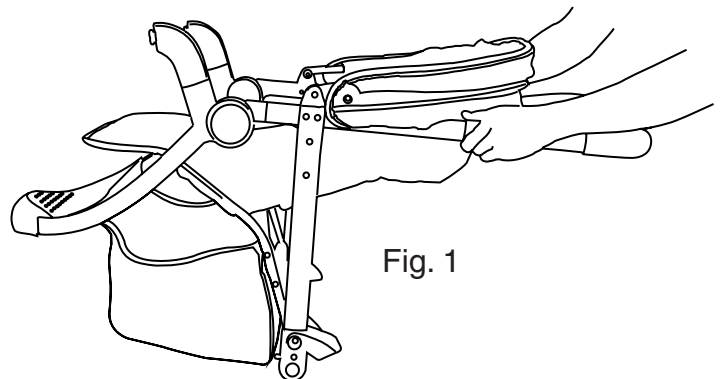

Fig. 1

2. Hook the front wheel axle into the front fork's slots (Fig. 1A).

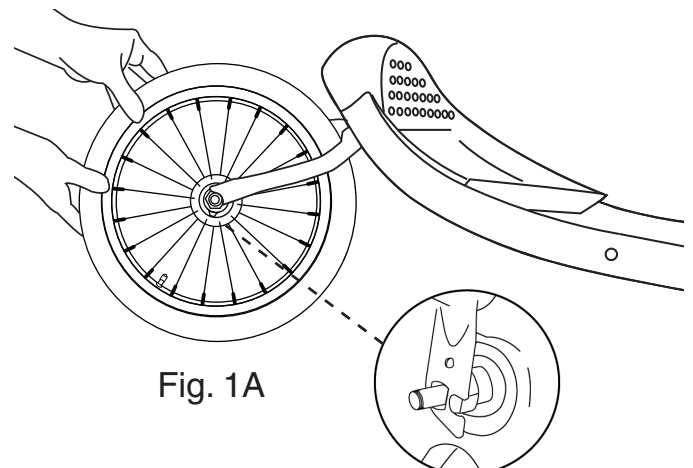
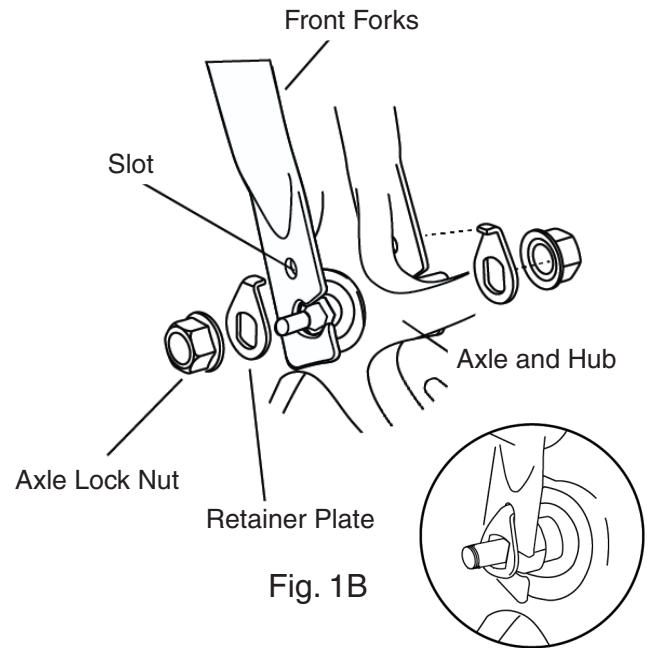

Fig. 1A

# ASSEMBLY

- Slide the retainer plate onto the front wheel axle. Be sure that the retainer plate's bent tab is facing towards the front fork slot. The bent tab on the retainer plate must be lined up with and trapped inside the front fork slot before tightening the wheel (Fig. 1B).



- Install the axle lock nuts and tighten with standard wrench, box or open end wrench. The front axle lock nut will be fully tighten and securely fastened when there is significant resistance to front fork. Repeat on other side. The wheel should be held tightly in place (Fig. 1C).

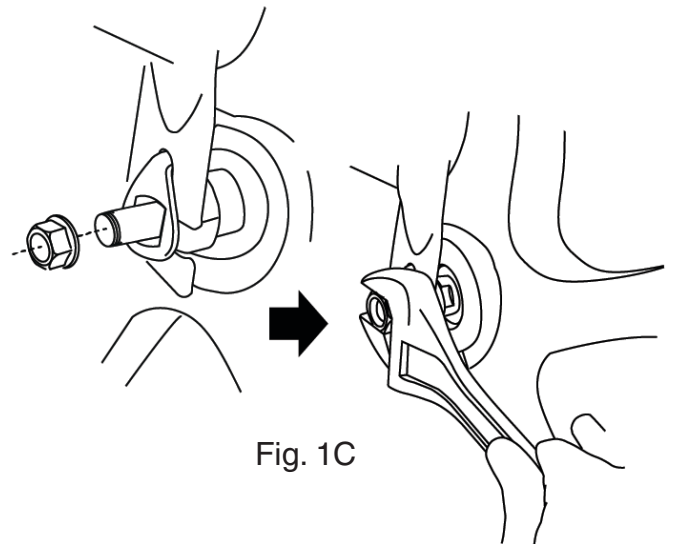

## TESTING FOR PROPER WHEEL INSTALLATION

### WARNING:

#### FALL HAZARD

Wheel can detach and cause tip over. Pull on the wheel to assure it is securely attached and make sure the front swivel wheel is in a locked position during running, jogging or walking fast.

**WARNING:** ALWAYS check that both front axle lock nuts are fully tighten before each use to ensure that the front wheel is securely fastened to the frame.

# ASSEMBLY

5. Lift the front wheel off of the ground and sharply strike the top of the tire. (Fig. 1D) The wheel should not be loose or come off.

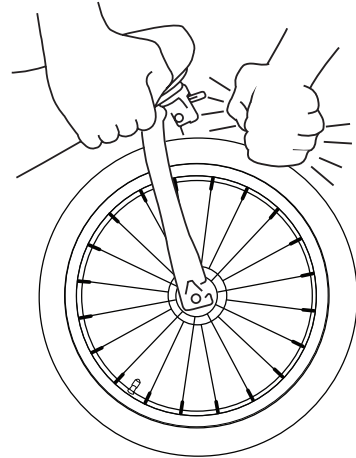

Fig. 1D

## REAR WHEEL

6. To attach the rear wheels, lay stroller on its side. Align back wheel axle to the stroller's rear wheel axle housing (Fig. 2). Push the back wheel axle inward until you hear a "click" (Fig. 2A). Once in a fully locked position, check to make sure back wheel is in a fully locked position by pulling outward. Repeat steps for other side back wheel. **NEVER** use stroller if any wheels are not in a fully locked position. Please contact our customer service department immediately at 1-800-377-3777 for assistance.

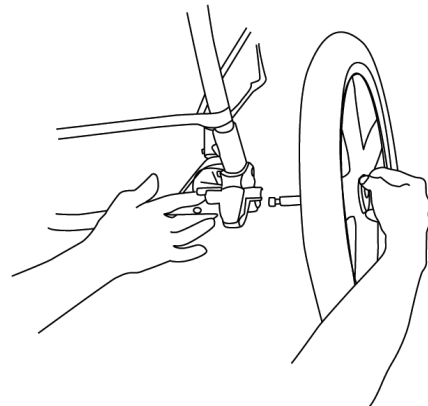

Fig. 2

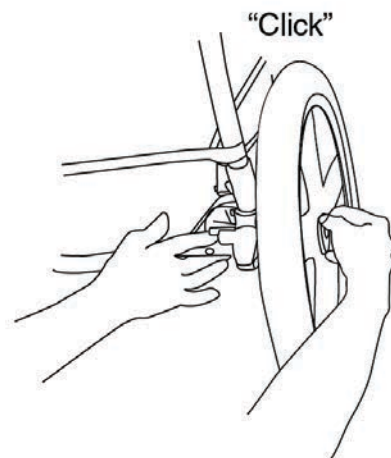

Fig. 2A

# ASSEMBLY

## PARENT TRAY

**WARNING:** The maximum weight that can be carried in the parent tray is 3 lbs (1.36 kg). NEVER place hot liquids in the parent tray as can cause serious burns and NEVER place more than 3lbs (1.36kg) in parent tray as may cause an unstable condition.

7. To attach parent fabric tray take velcro strap, wrap around jogger handle and put strap through clip (Fig. 3). Pull strap tight (Fig. 3A), and make sure velcro section is attached (Fig. 3B). Repeat 4X times on all sides until fabric tray is attached.



Fig. 3

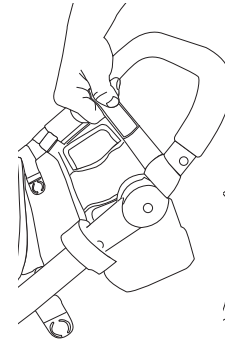

Fig. 3A

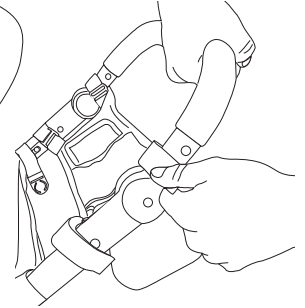

Fig. 3B

## CARRY ALL PARENT ORGANIZER

8. To attach parent organizer take velcro strap, wrap around jogger handle and put strap through clip (Fig. 4). Pull strap tight (Fig. 4A), and make sure velcro section is attached (Fig. 4B). Repeat on opposite handle until parent organizer is attached.

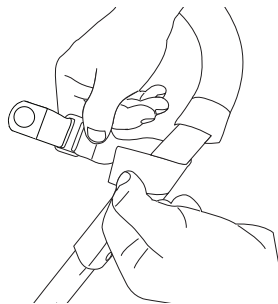

Fig. 4

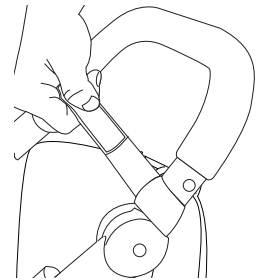

Fig. 4A

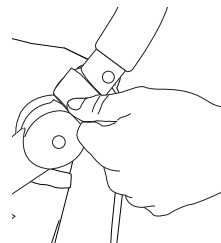

Fig. 4B



## CANOPY

9. To open the canopy: pull forward on the front edge of the canopy until fully opened. (Fig. 5) To close canopy: push backward on front edge until canopy is all the way collapsed. (Fig. 5A)

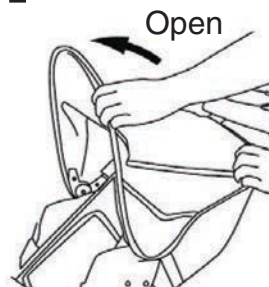

Fig. 5

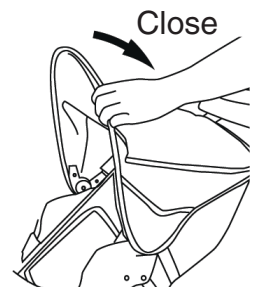

Fig. 5A



# ASSEMBLY

## SUN VISOR

10. To open the sun visor: grab front edge of sun visor under canopy and pull down and rotate forward until fully extended. (Fig. 6)

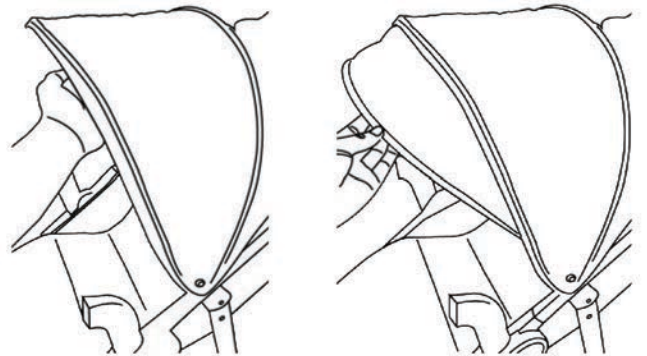

Fig. 6

## PEEK-A-BOO-WINDOW

11. To open, flip backwards to show peek-a-boo window. (Fig. 7)

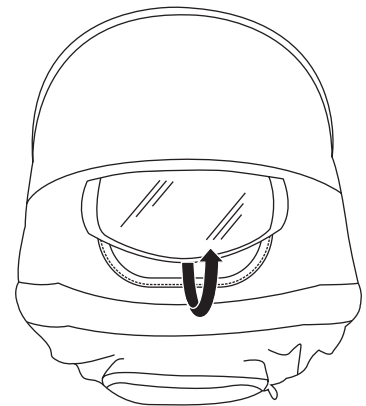

Fig. 7

## CHILD TRAY

12. To attach the child tray: Rotate and align left and right side of child tray posts with the left and right side stroller tray posts. Press left and right side child tray posts into left and right side stroller tray posts into a fully locked position. Press left side child tray button and snap child tray onto stroller tray posts. Release button to lock child tray onto stroller (Fig. 8). Repeat on right side of child tray. Check to make sure the child tray is securely attached to the stroller by pulling upward on the child tray.

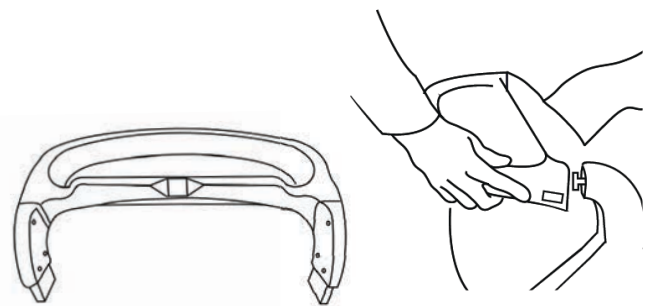

Fig. 8

# ASSEMBLY

13. To access child seat: press left or right release buttons (Fig. 8A) and rotate tray upward (Fig. 8B).

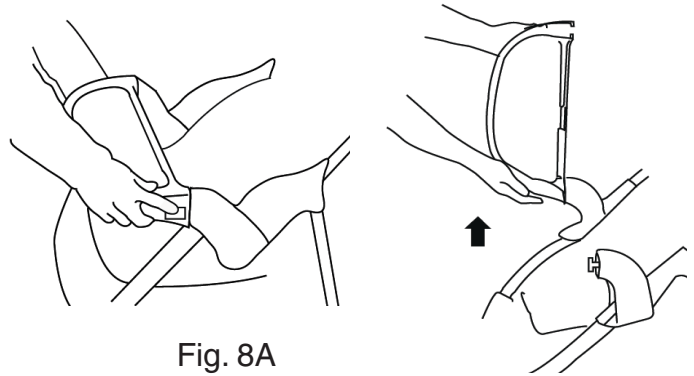

Fig. 8A

Fig. 8B

14. To remove the child tray: Press the right and left release buttons and pull upward on child tray. (Fig. 8C)

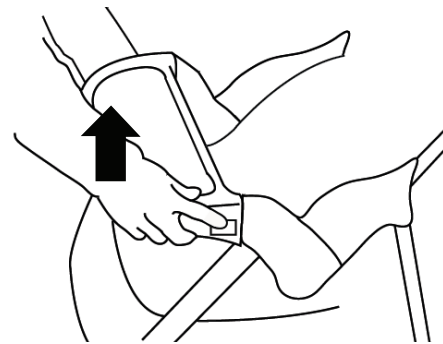
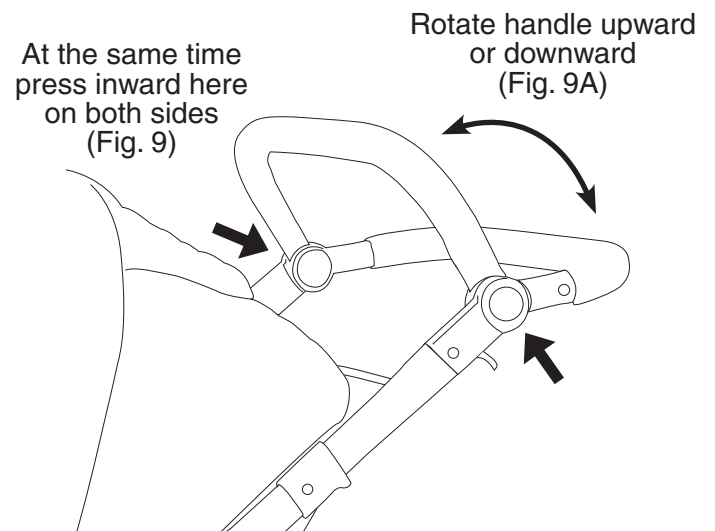

Fig. 8C

## ADJUSTABLE HANDLE

15. To adjust handle, first press handle release button (Fig. 9) and push handle upward or downward to desired position (Fig. 9A). When you here a "click" handle is safely locked into handle position.



# SAFETY

## BRAKES

**WARNING:** Always lock brakes when not in use on a hill or incline as stroller may roll away or slide down the hill.

---

**WARNING:** Never leave child unattended in stroller.

16. **Rear Wheel Brakes:** To lock rear wheel brakes, press downward on brake lever located on each rear wheel. (Fig. 10) Please note in order to line up the break tab with brake tab slots stroller may need to be moved forward or backwards slightly. Check to make sure the brakes are in a fully locked position, so stroller will not move when pushed. To release brakes, gently push up on the brake lever.

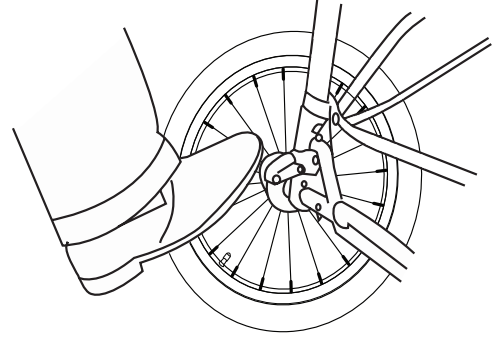

Fig. 10  
Rear Wheel  
Brakes

# TO SECURE THE CHILD

**Make sure the brake pedals are pressed down completely.**

Always set both brake pedals when parking the stroller.

## Before Placing your Child in Stroller:

Close Canopy. Press both brake pedals down until they “click” into the locked position.

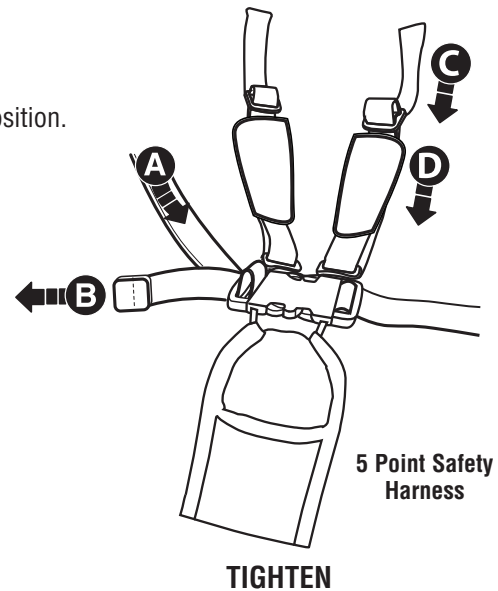
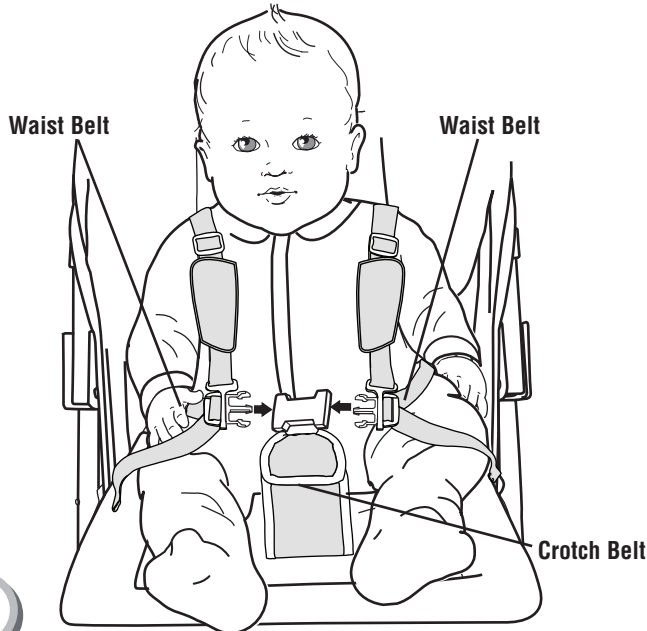

1

## Securing Child

- Place your child in the stroller. Position the crotch belt between your child's legs.
- Pull shoulder straps over child's arm and shoulder and fasten both strap ends to the restraint system.
- Fasten both waist belts to the buckle on each side of the crotch belt. Make sure you hear a “click” on both sides.
- Check to be sure the restraint system is securely attached by pulling it away from your child. The restraint system should remain attached.

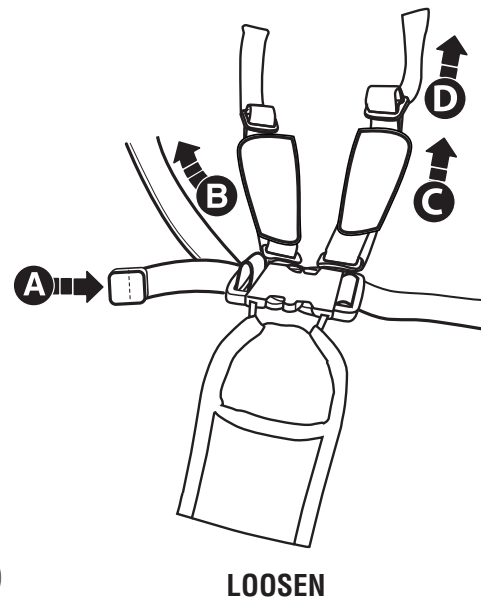

3

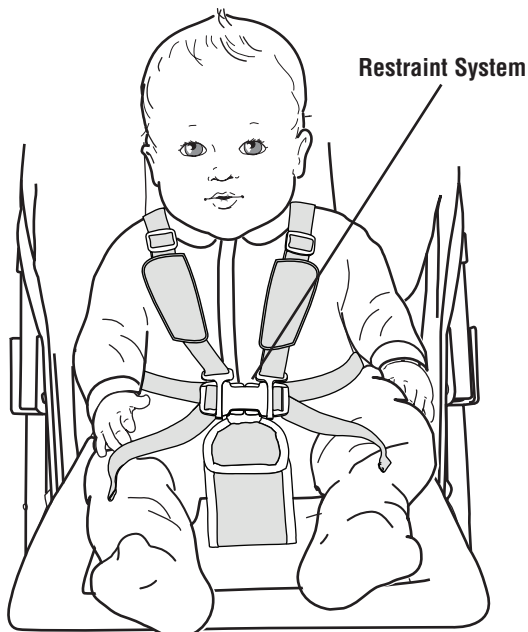

2

- Tighten each waist belt and shoulder strap so that the restraint system is snug against your child. Please refer to the next section for instructions to tighten the waist belts.

## To tighten the waist belts and shoulder straps:

- Feed the anchored end of a waist belt up through the buckle to form a loop **A**. Pull the free end of the waist belt **B**.
- Repeat this procedure to tighten the other waist belt.
- Feed the top end of the shoulder strap through the plastic stay to form a loop **C**. Pull the bottom end down to tighten the strap **D**.
- Repeat this procedure to tighten the other shoulder strap.

## To loosen the waist belts and shoulder straps:

- Feed the free end of the waist belt up through the buckle to form a loop **A**. Enlarge the loop by pulling on the end of the loop toward the buckle. Pull the anchored end of the waist belt to shorten the free end of the waist belt **B**.
- Repeat this procedure to loosen the other waist belt.
- Feed the bottom end of the shoulder strap through the plastic stay to form a loop **C**. Pull the top end up to loosen the strap **D**.
- Repeat this procedure to loosen the other shoulder strap.

Please note: After adjusting the restraint system to fit your child, make sure you pull on it to be sure it is securely fastened.

# ASSEMBLY

## SEAT BACK RECLINE POSITIONING

17. Squeeze both sides on cord housing and pull away to recline seat, as shown in Fig. 11.

To return to an upright position, hold bottom cord loops while squeezing cord housing and move cord housing upwards towards the backseat, as shown in Fig. 11A.

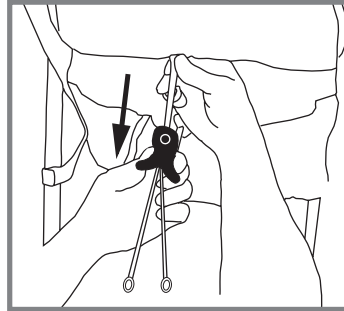

**RECLINE**

Fig. 11

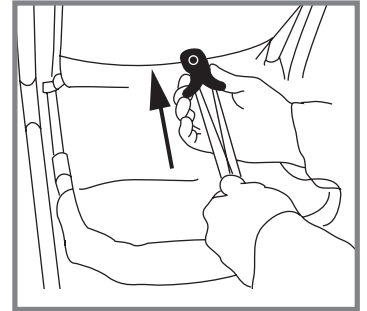

**UPRIGHT**

Fig. 11A

**WARNING:** Always keep the three back buttons attached to the back of the seat at all times.

18. Snap the three back buttons located on the back of the seat, as shown in Fig. 11B.

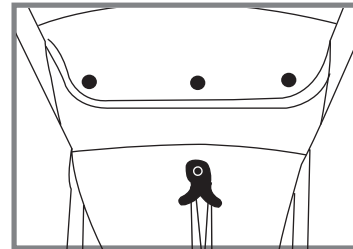

Fig. 11B

# ASSEMBLY

## HOW TO ATTACH GRACO® AND EVENFLO® CAR SEATS

19. To use the car seat feature, lock back wheels, close the canopy as described in the canopy section (Please see Page 7, Fig. 5A). Recline seat by squeezing both sides of cord housing as described in seat back positioning section (Please see Page 12, Fig. 11). Turn and lock grey latches (Fig. 12). Align car seat as shown in Fig. 12A. Angle feet first, while lowering car seat into a locked position on the child tray. Car seat is in a locked position when the car seat "CLICKS" into the child tray. Graco car seat locked position (Fig. 12B) Evenflo car seat locked position (Fig. 12C). Make sure car seat is locked in place by pulling upward on car seat. Make sure car seat is locked in place by pulling upward on car seat.

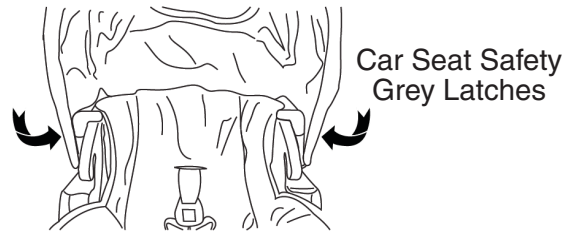
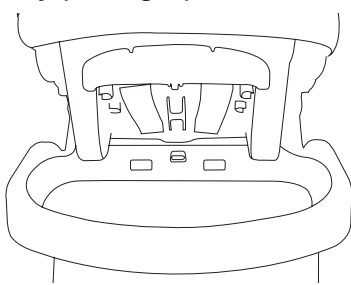

Fig. 12

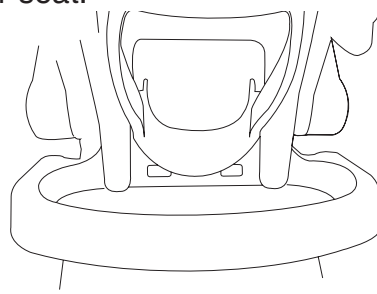

Fig. 12A



Back of Graco® Car Seat  
Graco® locked position -  
red locking tab clicks

Fig. 12B



Back of Evenflo® Car Seat  
Evenflo® locked position -  
grey locking tab clicks

Fig. 12C

20. Final step is to secure the car seat to the stroller using the straps with velcro. (Fig. 12D)

- The top strap is to secure Graco, Chicco, and Evenflo car seats only. **A**
- The lower velcro strap is to secure Britax car seats only. **B**

Fig. 12D

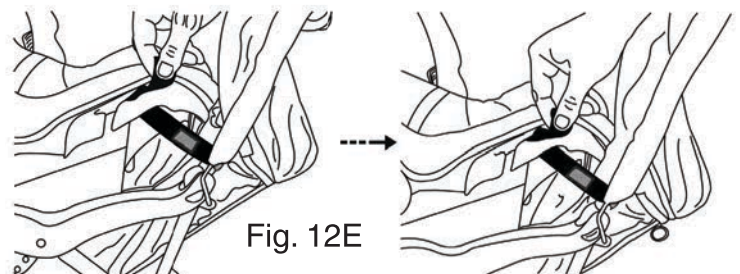
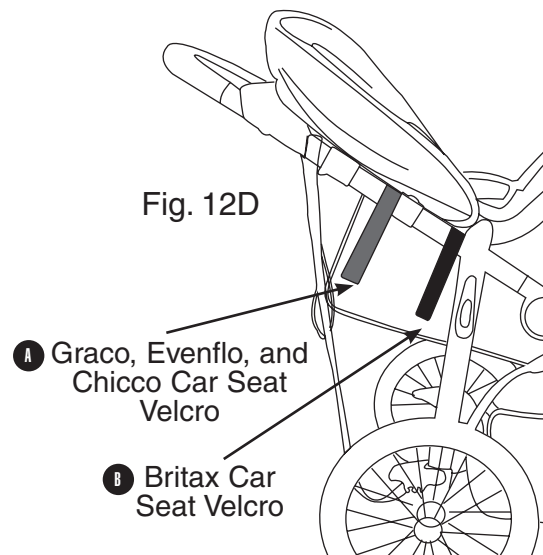

Fig. 12E

Secure the footrest side of car seat onto the stroller, use the straps with velcro to secure seat onto stroller. (Fig. 12E).

Check that car seat is securely attached by pulling up on the car seat. To remove, undo latches.

# HOW TO ATTACH CHICCO® CAR SEATS

21. To use Chicco Keyfit 30 Car seat first, lock the back wheels, close the canopy as described in the canopy section (Please see Page 7, Fig. 5A). Recline seat by squeezing both sides of cord housing as described in seat back positioning section (Please see Page 12, Fig. 11) remove child tray (Please see Page 9, Fig. 8C) and child tray attachment arms. Press the release buttons located on the inner side of stroller arm. Press release button and pull upward at the same time until tray attachment arm is released (Fig. 13).

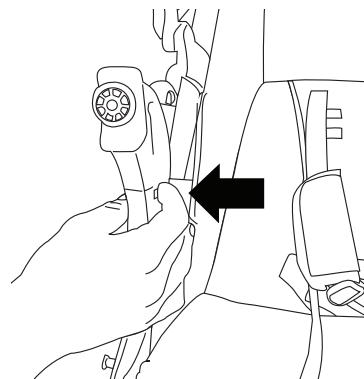

Fig. 13

22. Locate the Chicco left / right adapter. They are labeled on the inside (L This Side Facing In) and (R This Side Facing In). Line up the bottom of Chicco right side adapter (R This Side Facing In) with stroller arm post labeled "R" (Fig. 13A). Insert Chicco adapter into stroller right arm post (Fig. 13B). Make sure release button is securely fastened into right side slot by pulling upward to make sure Chicco adapter stays in place. Repeat with left side Chicco adapter.

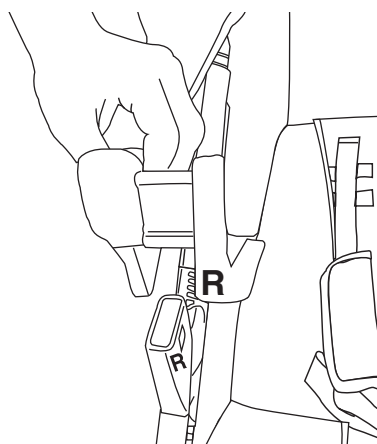
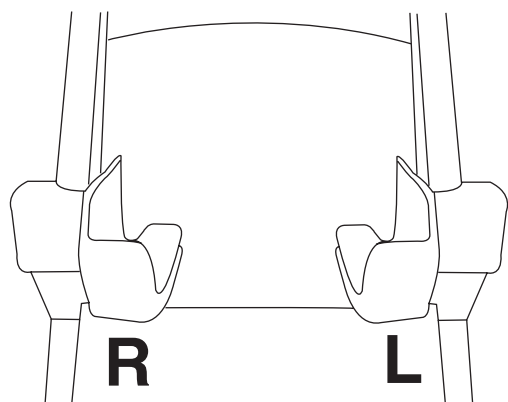
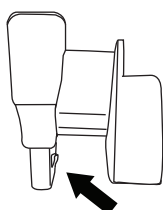

Fig. 13A



Correct Placement  
When Facing Into Stroller

Right Side  
Front View



Left Side  
Front View

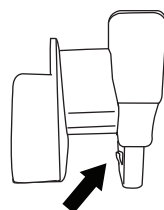

Insert With Locking  
Tab Facing Inward



Fig. 13B

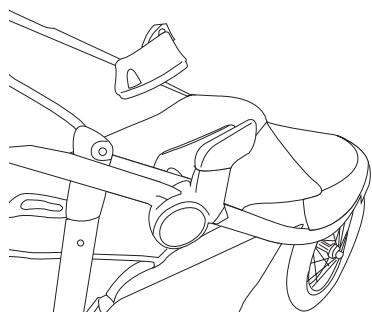

Chicco Car Seat  
Adapters Attached  
To Stroller

23. To attach Chicco car seat, line up foot end of car seat toward stroller (Fig. 13C). Slide car seat into Chicco adapters. Make sure car seat is locked in place by pulling upward on car seat. Car seat is secured when both side lock tabs have "clicked" into place and car seat does not lift up. (Fig. 13D) To remove car seat, lift the back lever located on the back of the car seat and lift car seat upward to fully remove.

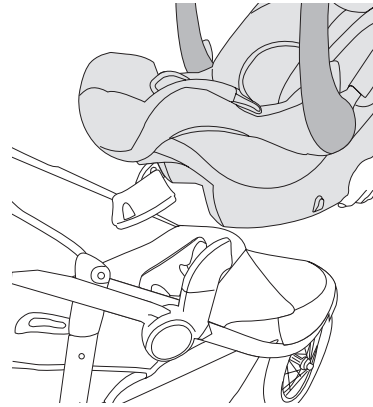

Fig. 13C

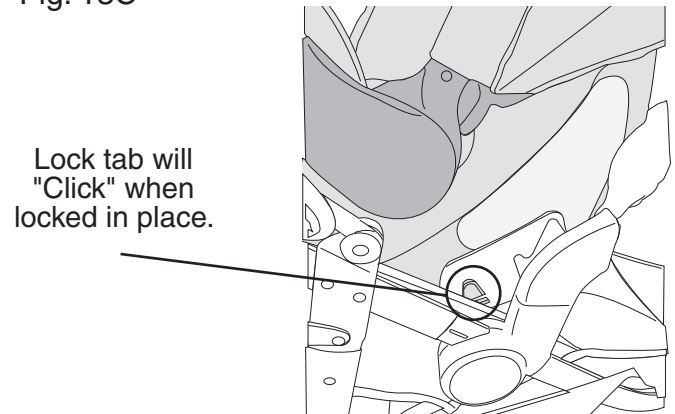

Fig. 13D

24. Final step is to secure the car seat to the stroller using the straps with velcro. (Fig. 13E)

- The top strap is to secure Graco, Chicco, and Evenflo car seats only. **A**
- The lower velcro strap is to secure Britax car seats only. **B**

Secure the footrest side of car seat onto the stroller, use the straps with velcro to secure seat onto stroller. (Fig. 13F).

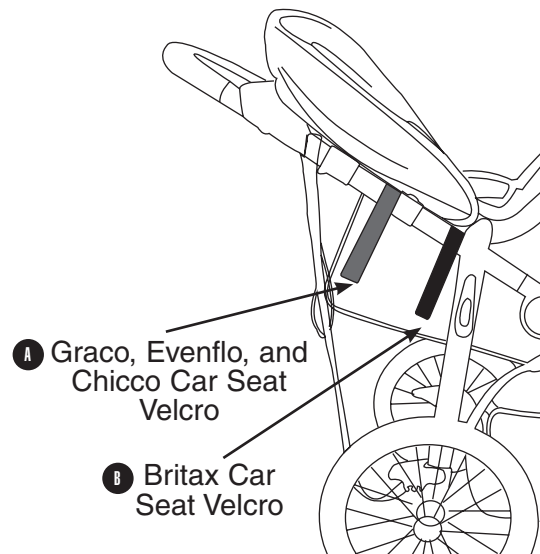

Fig. 13E

Check that car seat is securely attached by pulling up on the car seat. To remove, undo latches.

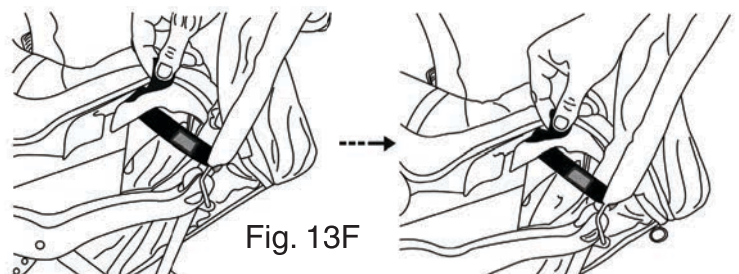

Fig. 13F



# HOW TO ATTACH BRITAX CAR SEATS

25. To use Britax B-Safe 35 Car seat first, lock the back wheels, close the canopy as described in the canopy section (Please see Page 7, Fig. 5A). Recline seat by squeezing both sides of cord housing as described in seat back positioning section (Please see Page 12, Fig. 11) remove child tray (Please see Page 9, Fig. 8C) and child tray attachment arms. Press release button and pull upward at the same time until tray attachment arm is released. (Fig. 14)

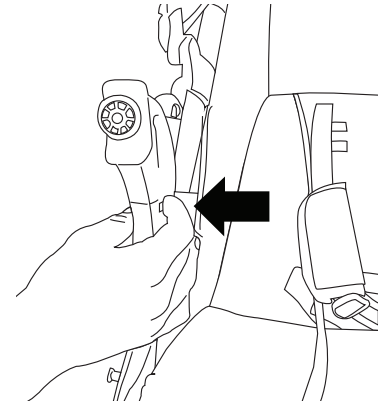
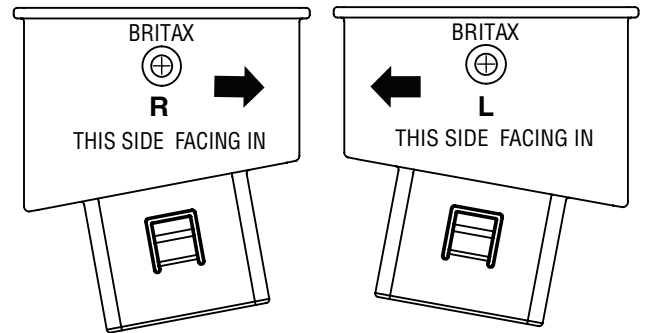

Fig. 14

26. Locate the Britax left / right adapter. They are labeled on the inside (L This Side Facing In) and (R This Side Facing In) (Fig. 14A). Line up the bottom of Britax right side adapter (R This Side Facing In) with stroller arm post labeled "R" (Fig. 14B). Insert Britax adapter into stroller right arm post (Fig. 14C). Make sure release button is securely fastened into right side slot by pulling upward to make sure Britax adapter stays in place. Repeat with left side Britax adapter.



Inner Side of Adapters  
Fig. 14A

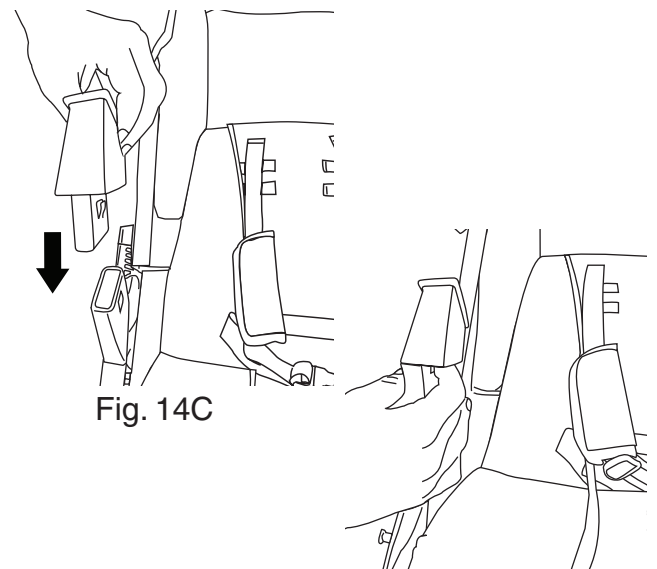
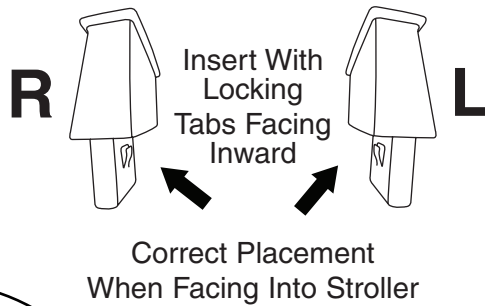

Fig. 14C

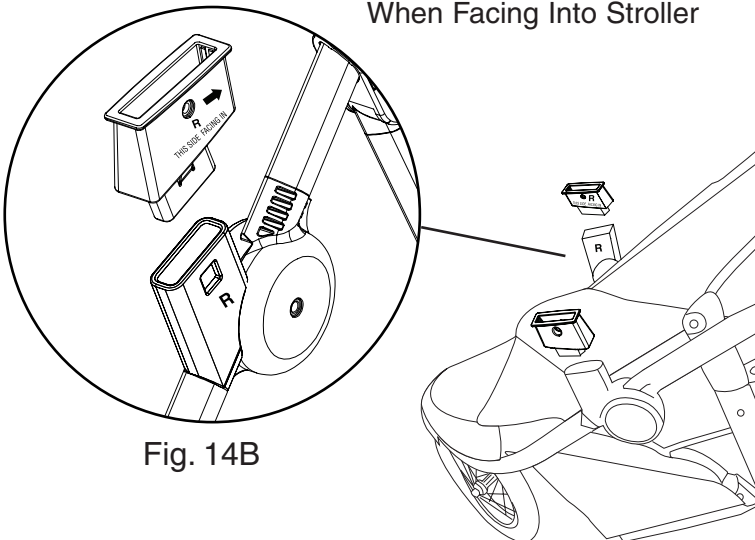

Fig. 14B

27. To attach Britax B-Safe 35 car seat, line up foot end of car seat toward stroller (Fig. 14D). Glide car seat into Britax attachments. Make sure car seat is locked in place by pulling upward on car seat. Car seat is secure once both side lock tabs have "clicked" into place and car seat does not lift up. (Fig. 14E) To remove car seat, lift the back lever located on the back of the car seat and lift car seat upward to fully remove.

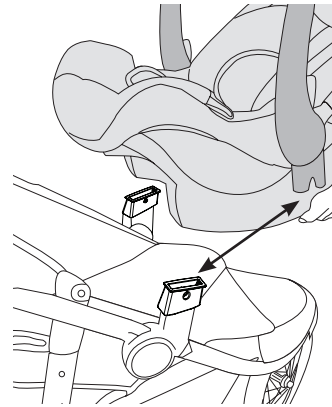
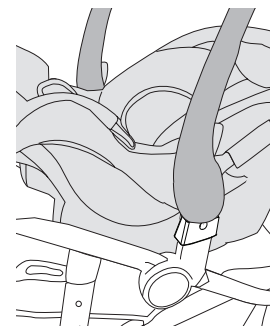

Fig. 14D



Car seat will "CLICK" when locked in place.

Fig. 14E

28. Final step is to secure the car seat to the stroller using the straps with velcro. (Fig. 14F)

- The top strap is to secure Graco, Chicco, and Evenflo car seats only. **A**
- The lower velcro strap is to secure Britax car seats only. **B**

Secure the footrest side of car seat onto the stroller, use the straps with velcro to secure seat onto stroller. (Fig. 14G).

Check that car seat is securely attached by pulling up on the car seat. To remove, undo latches.

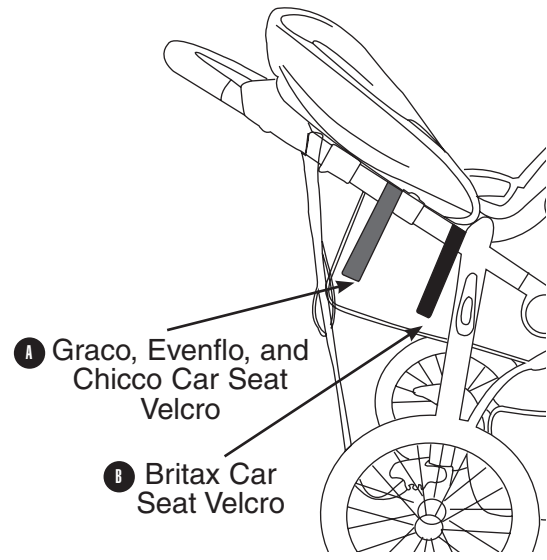

Fig. 14F

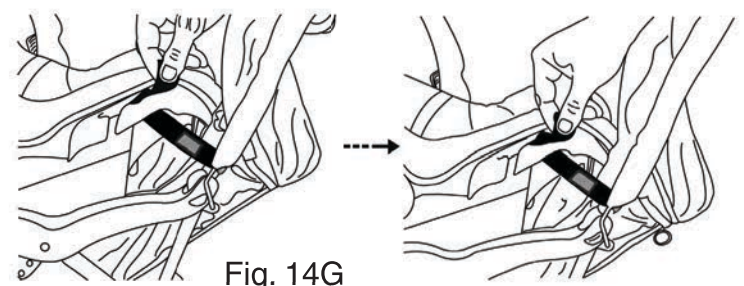

Fig. 14G

# ASSEMBLY

## JOGGING WITH YOUR STROLLER

29. When you are jogging with your child, use the following safety features:

- **LOCK THE FRONT SWIVEL WHEEL BY PUSHING UPWARD ON THE FRONT SWIVEL WHEEL LOCK PUTTING THE FRONT WHEEL INTO A STRAIGHT POSITION. (Fig. 15)**
- **SAFETY TETHER STRAP:** Always connect the safety tether strap to either right or left wrist when jogging. The tether strap will keep the stroller from moving or rolling away in the event that you trip or stumble while running. (Fig. 15A) The safety tether strap must remain connected to the rear lower frame cross member at all times. The safety tether strap can be stored on the left or right side of the stroller with the velcro attachment, when not in use. (Fig. 15B)
- **NOTE:** Do not remove the safety tether strap from the bottom wheel axle as it is intended to prevent the stroller from tipping backwards if the stroller happens to move or roll away in the event that you trip or stumble.

Push Upward To  
Lock Front Swivel  
Wheel

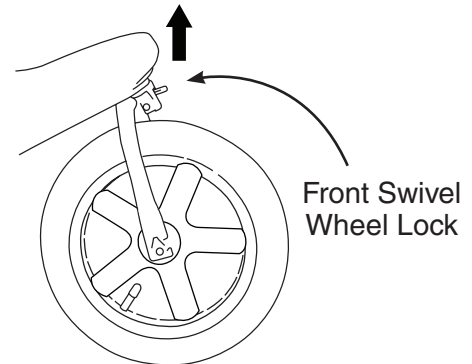

Fig. 15

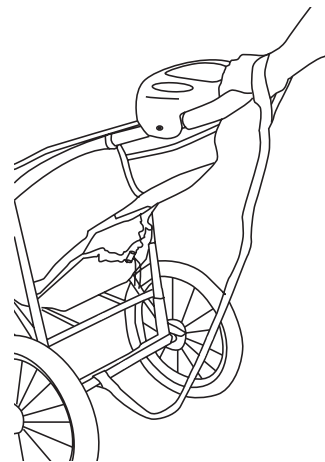

Fig. 15A

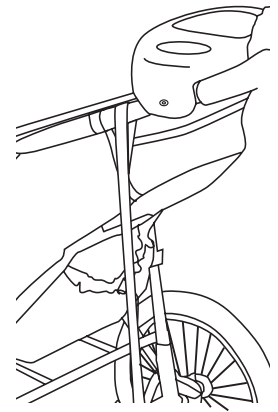

Fig. 15B

## TO FOLD STROLLER

**WARNING:** Care must be taken when folding and unfolding the stroller to prevent finger entrapment.

30. Close the canopy as described in the canopy section (Please see Page 7 Fig. 5A). Recline seat by releasing buckle as described in seat back positioning section (Please see Page 12 Fig. 11).

- The stroller is folded by simultaneously pulling each trigger fold located on right and left handle above the canopy (Fig. 16). When the fold latches are released, the handle will begin to rotate and lower toward the floor.

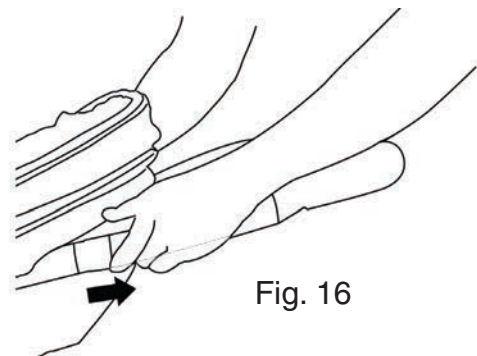

Fig. 16

# ASSEMBLY

31. Release the fold buttons and move handle downward until the stroller is completely folded. The stroller is in a fully locked position when the locking fold latch is locked over the “T” post, located on the right side of the stroller. (Fig. 16A)

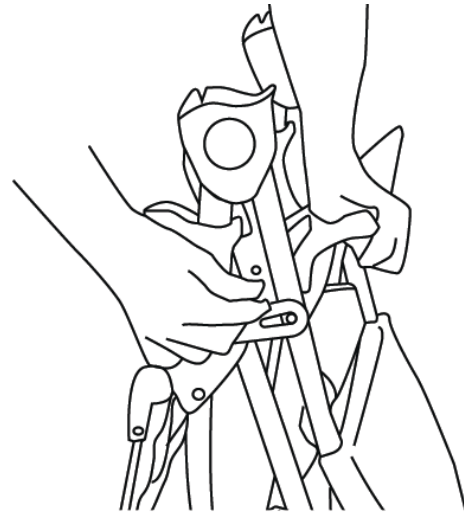

Fig. 16A

## TO UNFOLD STROLLER

**WARNING:** Care must be taken when folding and unfolding the stroller to prevent finger entrapment.

32. Place the stroller on the ground with all three wheels touching the ground. Release the locking folding latch, which is located on the right side. (Fig. 17)

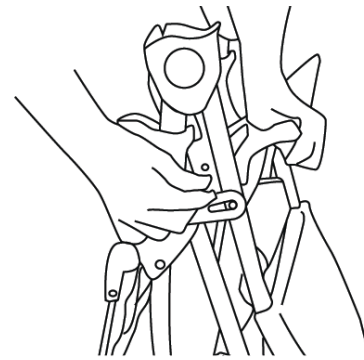

Fig. 17

- Lift up on the stroller handle with both hands until the stroller frame is in a fully opened and locked open position. (Fig. 17A) The stroller is in a fully locked position when both side handle latches are in a fully locked position. Prior to placing your child into the stroller, test to make sure both latches are fully engaged and fully locked.

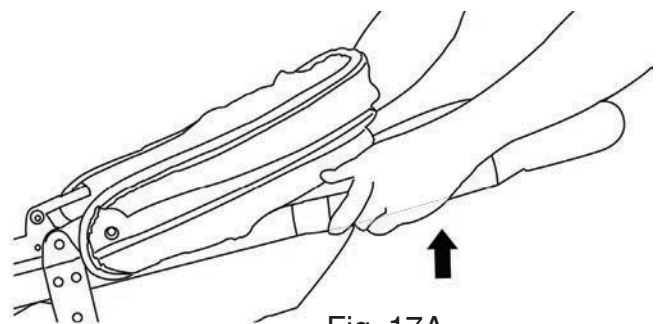

Fig. 17A

# OTHER

## FLAT TIRE

The jogging stroller features bicycle air tires which could become flat. If you have a flat tire, use a standard bicycle hand air pump to inflate the tires. Inflate the tires 25 psi.

NOTE: The stroller air tires can be taken to a bicycle shop for flat tire repair.







**Delta Childrens Products Corp.**

114 West 26th Street  
New York, NY 10001  
1-800-377-3777  
[www.DeltaChildren.com](http://www.DeltaChildren.com)