

BRITAX® CAR SEAT ADAPTER



J is for Jeep
Brand

INSTRUCTION MANUAL

ADULT ASSEMBLY REQUIRED
10040-2294



For Britax® B-Safe 35™
Infant Car Seat

Car seat adapter will fit onto all 11998 and 11988 Styles

Read all instructions BEFORE assembly and USE of product.
KEEP INSTRUCTIONS FOR FUTURE USE.

Customer Service: 1-(800)-377-3777
www.deltachildren.com

Jeep, the Jeep grille and related logos, vehicle model names and trade dress are trademarks of FCA US LLC and used under license by Delta Enterprise Corp. © 2017 FCA US LLC.

Copyright © Britax. All rights reserved.



DCP IM 04 26 17

WARNING

WARNING: Please follow all of these instructions to ensure the safety of your child. Keep these instructions for future reference.

WARNING: Failure to follow these instructions could result in serious injury or death.

WARNING: Avoid serious injury from falling or sliding out. Always insure that the child is properly positioned by using the safety harness according to these instructions.

WARNING: Never leave children unattended.

WARNING: FALL HAZARD from tip over. Before running, jogging, or walking fast, LOCK the front wheel from swiveling.

CAUTION: This is a single occupant jogging stroller for one child only. The use of more than one child may cause an unstable condition which can injure your child. Do not place parcels, diaper bags or accessory items on jogging stroller as this can cause an unstable condition.

- The maximum weight that can be carried in the lower basket, child tray, parent fabric tray and carry all parent organizer each is 3 lbs (1.36 kg).
- Before allowing the children near the stroller, be certain the stroller is fully erect and latched in the open locked position.
- Use of the stroller with children weighing more than 50 pounds (22.62 kg) or over 42 inches (106.7 cm) tall, may cause a hazardous unstable condition to the stroller.
- **NEVER** use the stroller on stairways.
- **NEVER** use the stroller in conjunction with bicycles, skateboards, roller skates, or in-line skates. Please discuss using the jogging stroller with your health care provider prior to jogging use. We recommend that the child occupant needs to be 6 months of age, at the minimum, before use of the stroller.

CARE AND MAINTENANCE

- To clean the stroller use a mild household soap with warm water on a sponge or clean cloth.
- Check your stroller for loose screws, worn parts, torn material or stitching on a regular basis. Replace or repair parts as needed.
- Discontinue use of stroller if it should become damaged or malfunctions. Please contact our customer service number 1-800-377-3777 to arrange for repair or obtain replacement parts.
- If you experience any difficulty with assembly, missing parts or use, please DO NOT return this item to the store. Retail stores are unable to properly assist you. Contact our Customer Service Department directly for assistance 1-800-377-3777.

Parts

IMPORTANT! Please remove all parts from the package and identify them before assembly.

IMPORTANT! Before assembly and each use, inspect this product for damaged hardware, loose joints, missing parts, or sharp edges. NEVER use if any parts are missing or broken. Contact manufacturer for replacement parts and instructions if needed. Never substitute parts. **IMPORTANT!** Adult assembly required.



Right Side
Front View



Left Side
Front View

Britax Car Seat Adapter

Part # 50231

Attaching Adapter

WARNING: Always lock brakes when not in use on a hill or incline as stroller may roll away or slide down the hill.

WARNING: Never leave child unattended in stroller.

NOTE: Before attaching Britax Adapters, complete steps 1-1D.

1. To use Britax B-Safe 35 car seat first, lock the back brakes. To lock rear wheel brakes, press downward on brake lever located on each rear wheel (Fig. 1). Please note in order to line up the break tab with brake tab slots stroller may need to be moved forward or backwards slightly. Check to make sure the brakes are in a fully locked position, so stroller will not move when pushed. To release brakes, gently push up on the brake lever.

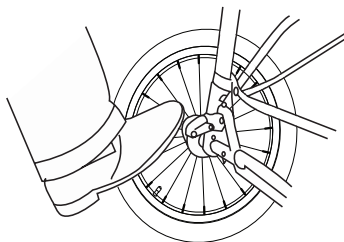

Fig. 1

Rear Wheel Brakes

2. To close the canopy, push backward on the front edge until canopy is all the way collapsed (Fig. 1A).

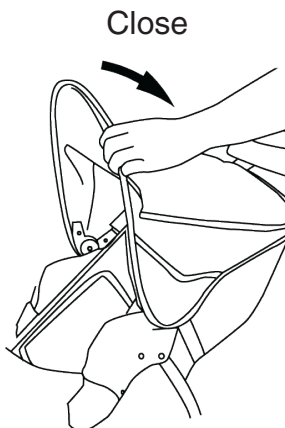
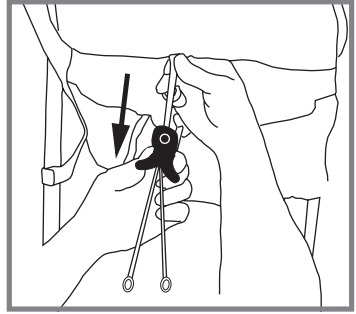

Fig. 1A

3. Recline seat by squeezing both sides of cord housing (Fig. 1B).



RECLINE

Fig. 1B

4. To remove the child tray, Press the right and left release buttons and pull upward on child tray (Fig. 1C).

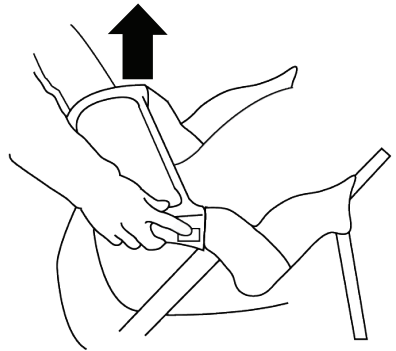

Fig. 1C

5. To remove the child tray attachment arms located on both sides, press the release buttons located on the inner side of the stroller arms, and pull upward at the same time until child tray attachment arms are released. (Fig. 1D).

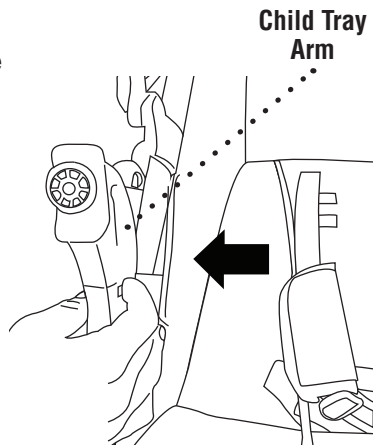
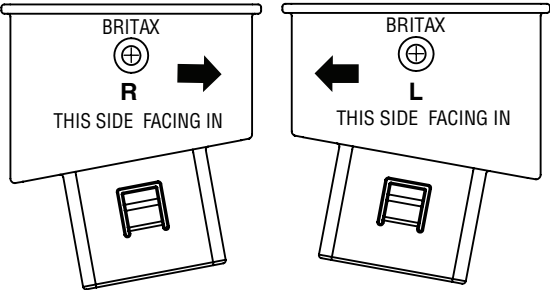
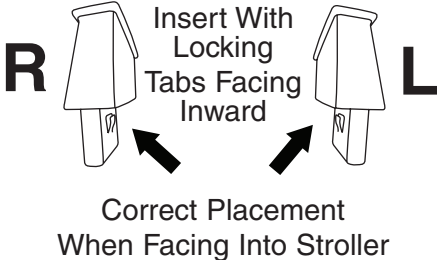

Fig. 1D

6. Locate the Britax left / right adapter. They are labeled on the inside (L This Side Facing In) and (R This Side Facing In) (Fig. 2). Line up the bottom of Britax right side adapter (R This Side Facing In) with stroller arm post labeled "R" (Fig. 2A). Insert Britax adapter into stroller right arm post (Fig. 2B). Make sure release button is securely fastened into right side slot by pulling upward to make sure Britax adapter stays in place. Repeat with left side Britax adapter.



**Inner Side of
Adapters**
Fig. 2



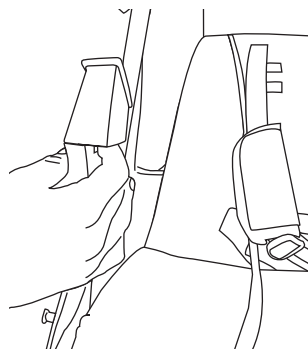
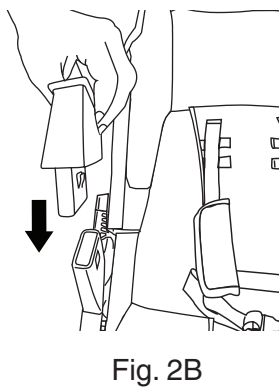
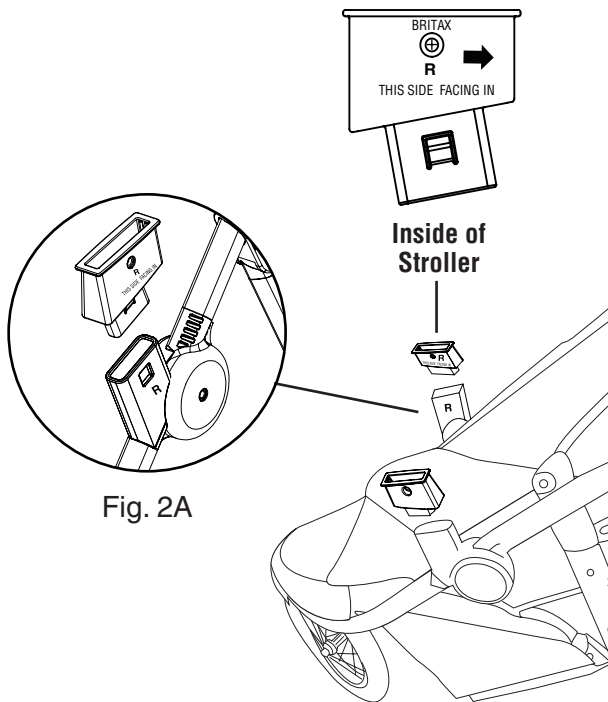

7. To attach Britax B-Safe 35 car seat, line up foot end of car seat toward stroller (Fig. 3). Glide car seat into Britax attachments. Make sure car seat is locked in place by pulling upward on car seat. Car seat is secure once both side lock tabs have "clicked" into place and car seat does not lift up. (Fig. 3A) To remove car seat, lift the back lever located on the back of the car seat and lift car seat upward to fully remove.

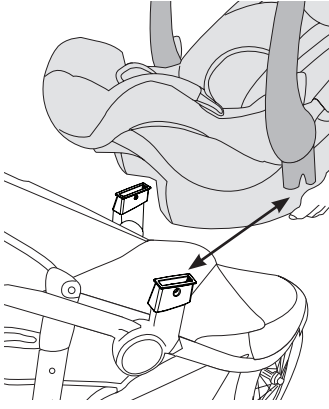
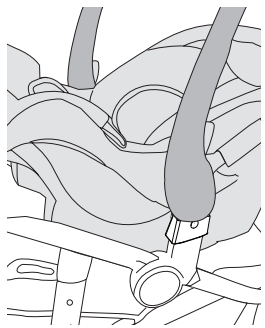

Fig. 3



Car seat will "CLICK" when locked in place.

Fig. 3A

8. Final step is to secure the car seat to the stroller using the straps with velcro. (Fig. 4)

- The top strap is to secure Graco, Chicco, and Evenflo car seats only. **A**
- The lower velcro strap is to secure Britax car seats only. **B**

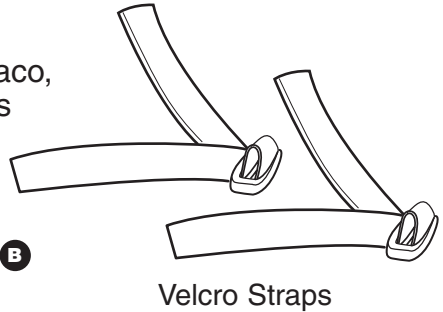

Secure the footrest side of car seat onto the stroller, use the straps with velcro to secure seat onto stroller. (Fig. 4A).

Check that car seat is securely attached by pulling up on the car seat. To remove, undo latches.

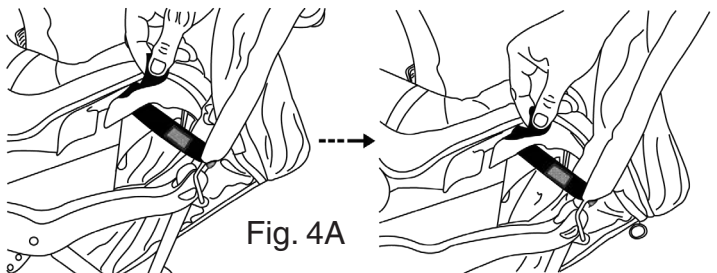
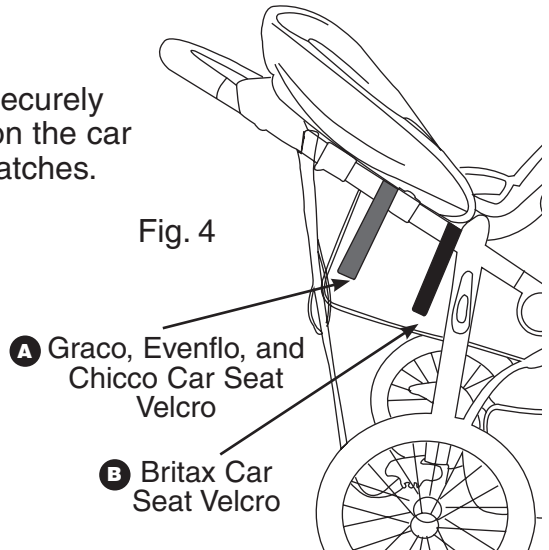



Delta Childrens Products Corp.

114 West 26th Street
New York, NY 10001
1-800-377-3777
www.deltachildren.com