

Assembly Instruction

Applicable product model :

Fulton

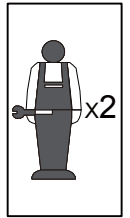
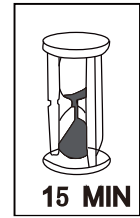

M6x20



a=4



b=6



c=2

M8x55



d=3



e=3



g=2



4mm



5mm



B=2

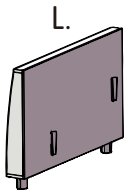

C=1

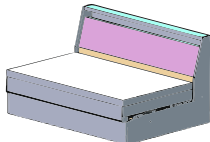

D=1

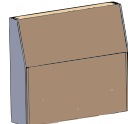

E=1

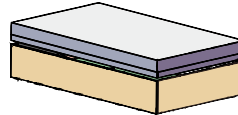

F=1

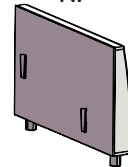

H=1

step1

4x

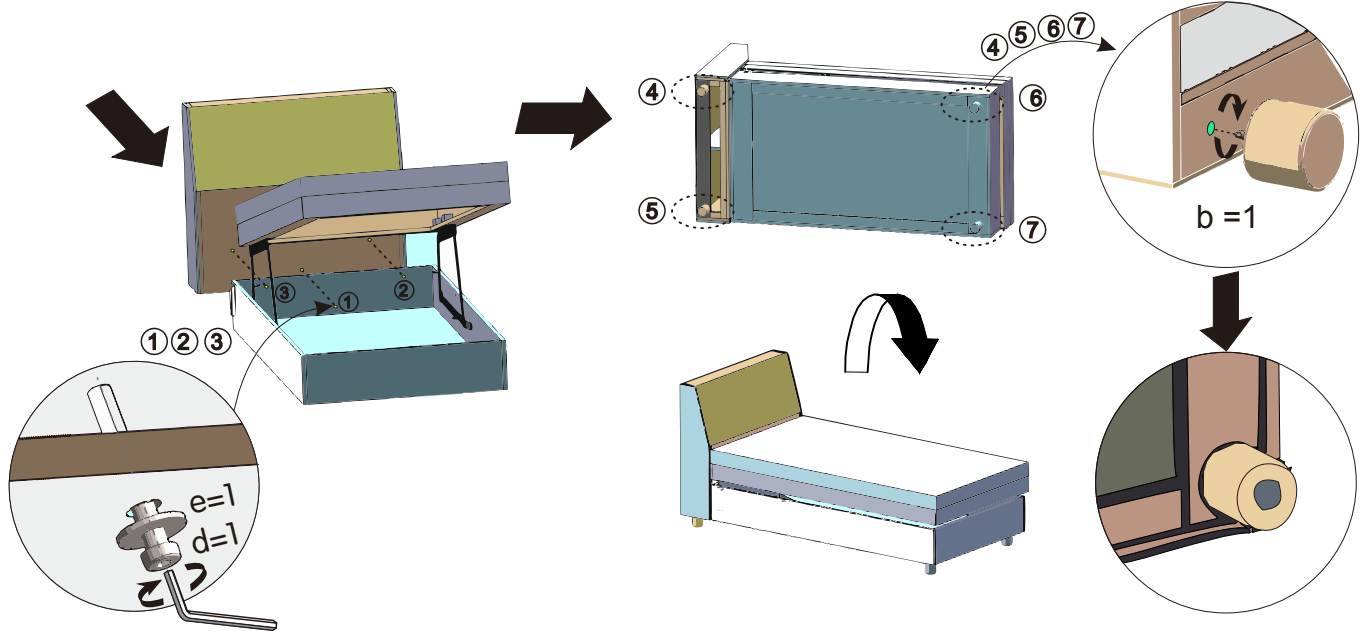

step2

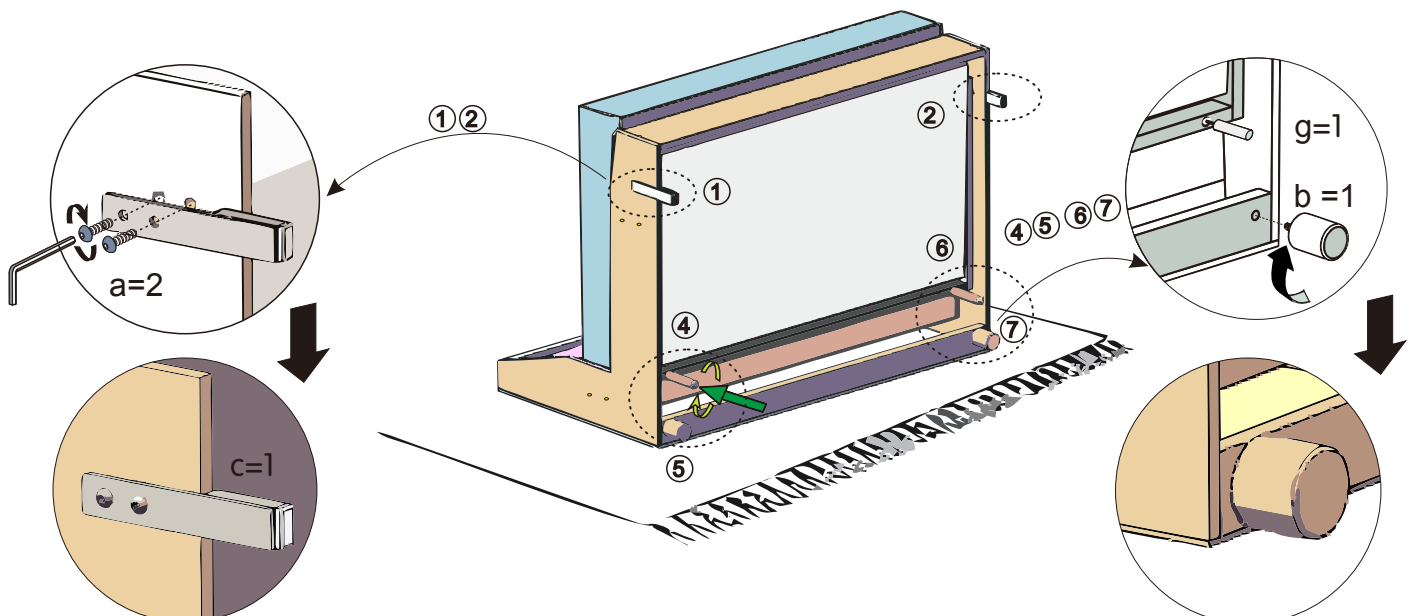

Assembly Instruction

Applicable product model :

Fulton

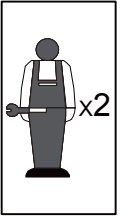
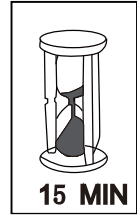

M6x20



a=8 h=4

step3

L.

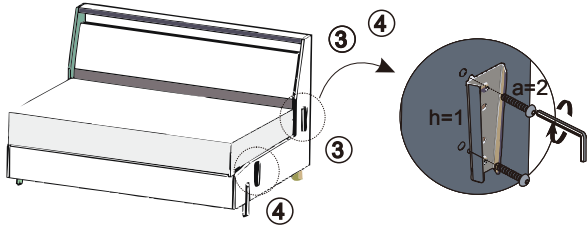
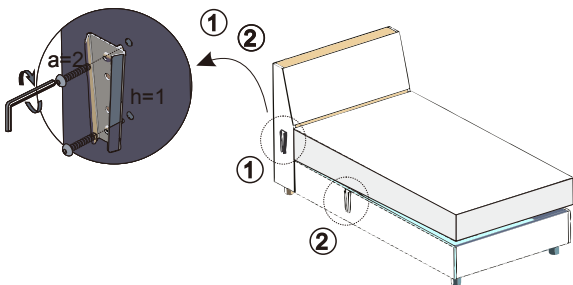
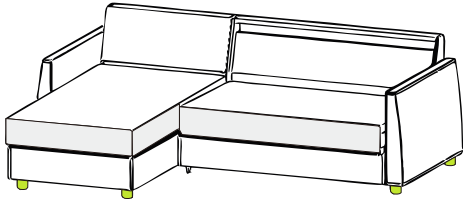

R.

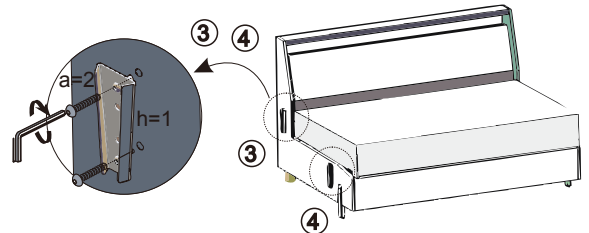
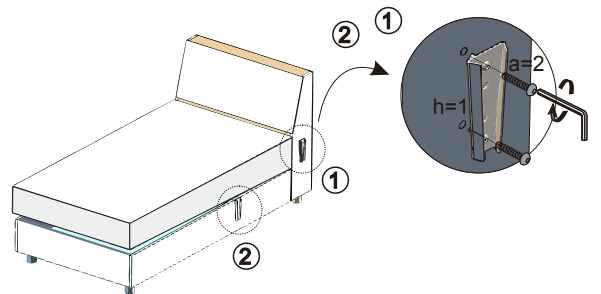
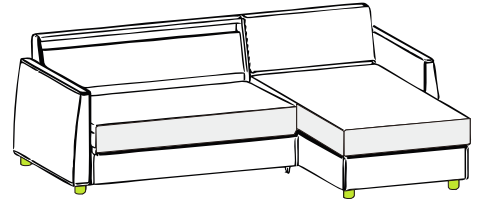

step4

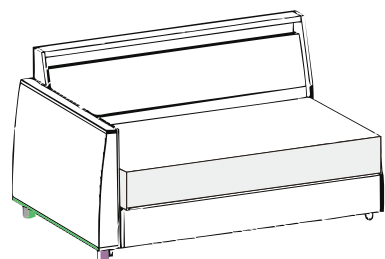
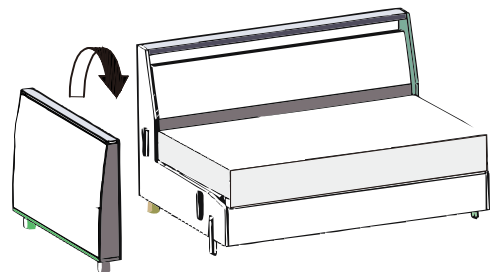
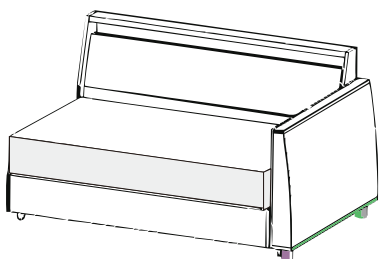
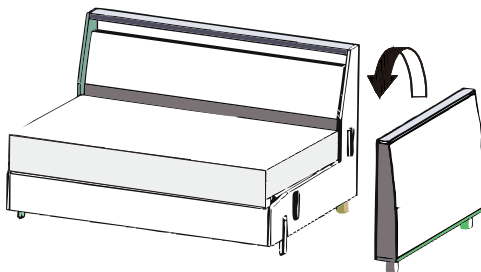

Assembly Instruction

M6x50

Ø8



j=1

k=1

Applicable product model :

Fulton

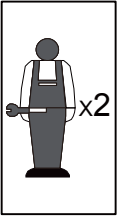
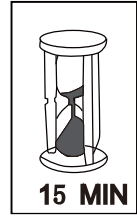

step5

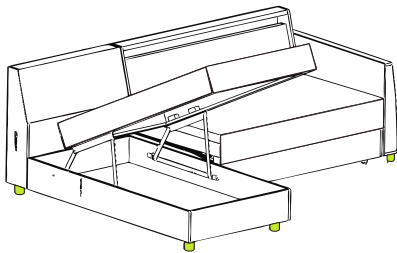
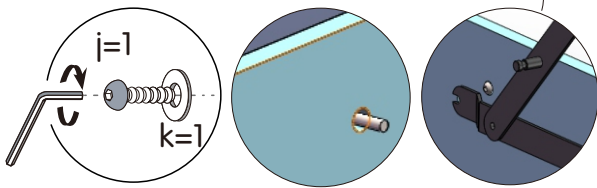
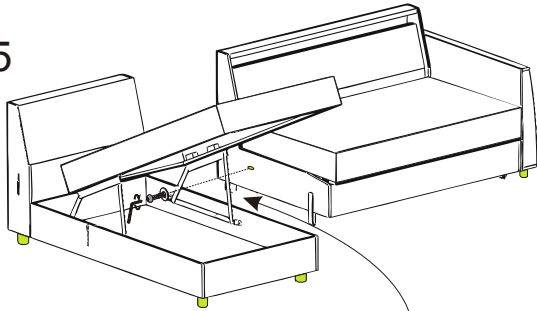

step6

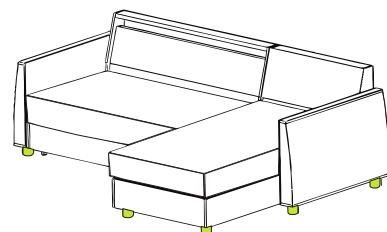
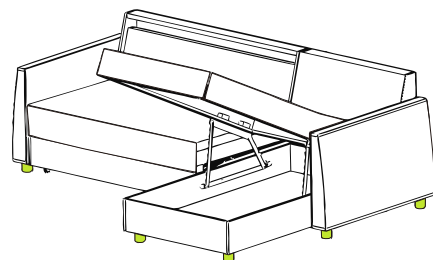
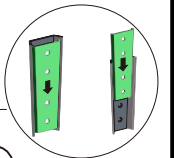
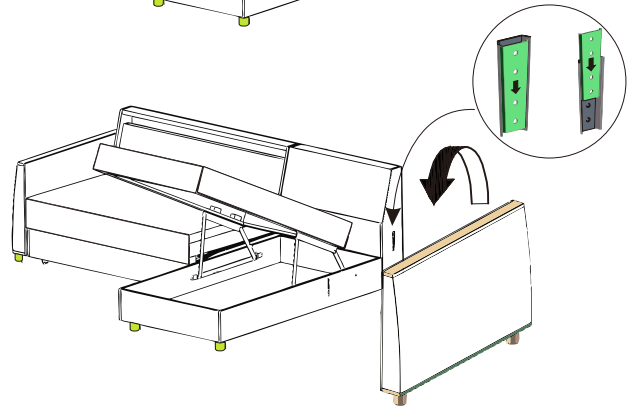
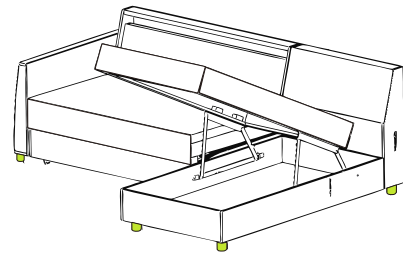
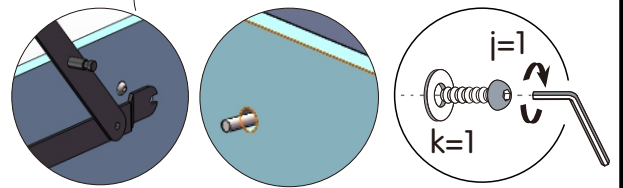
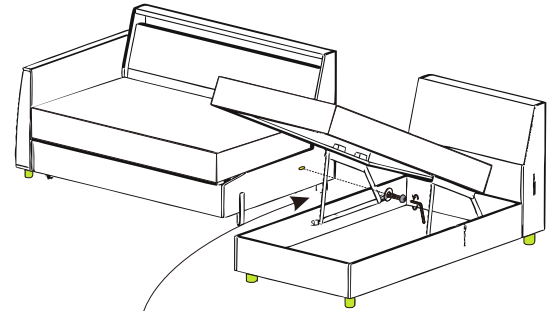
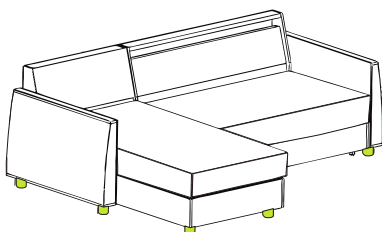
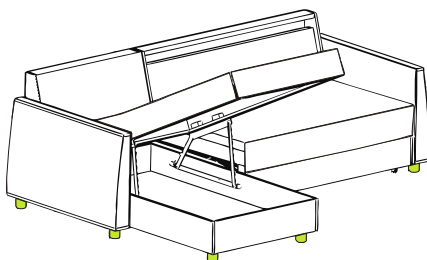
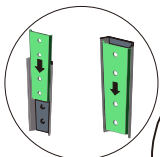
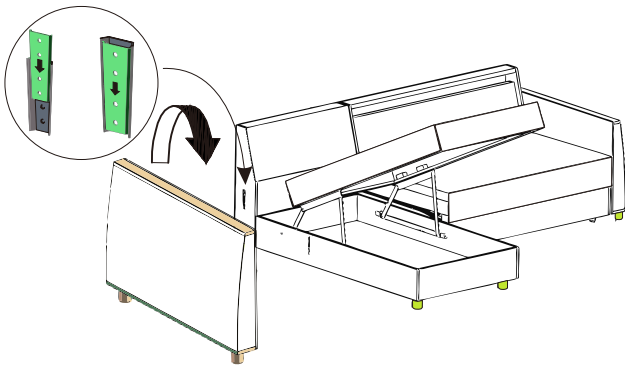

Assembly Instruction

Applicable product model :

Fulton

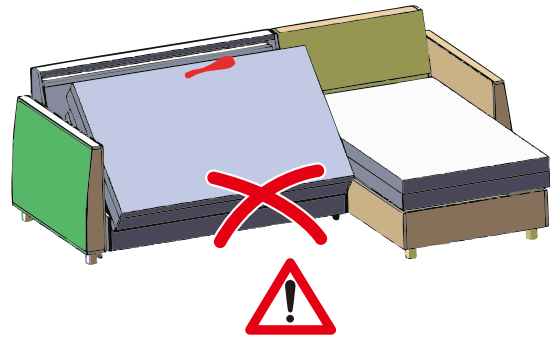

step1

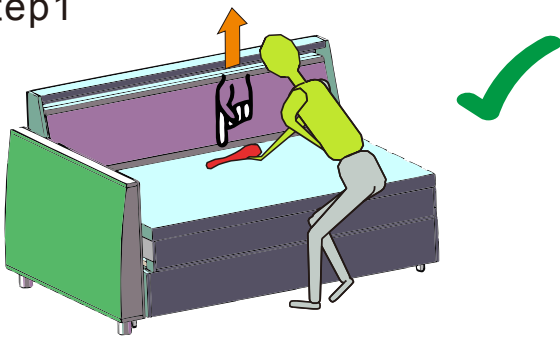

step2

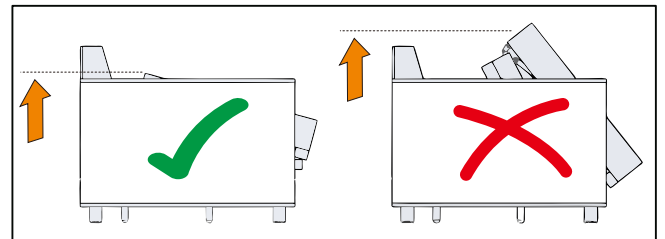
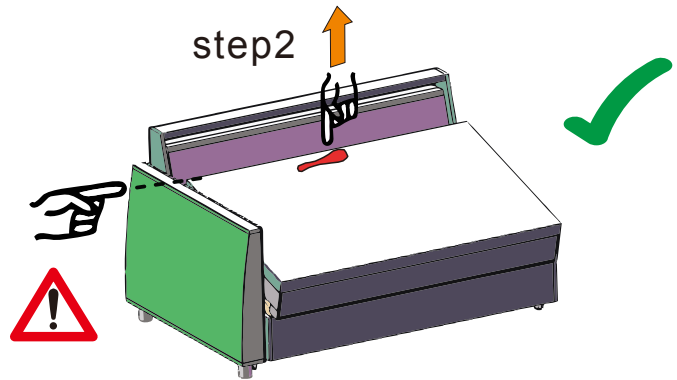

step3

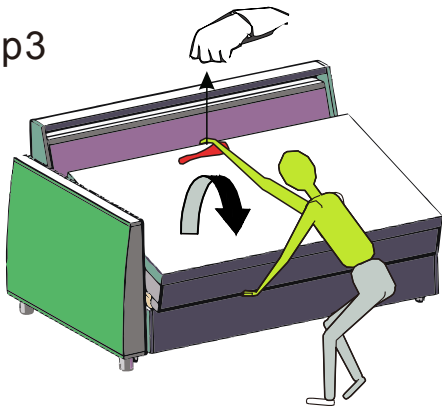

step4

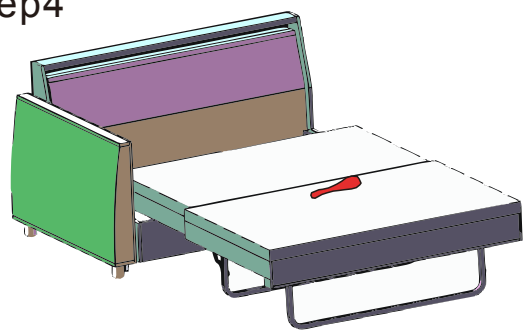

step5

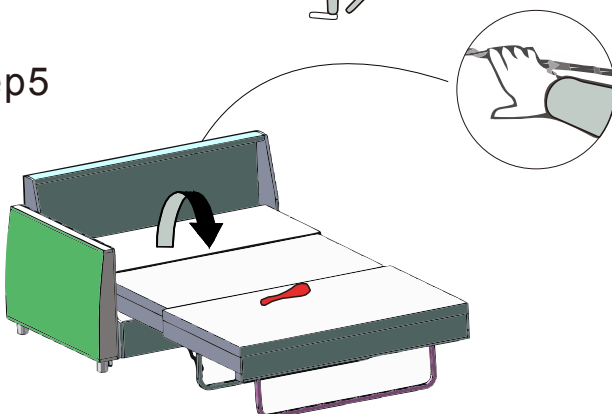

Assembly Instruction

Applicable product model :

Fulton

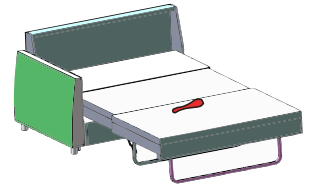

step1

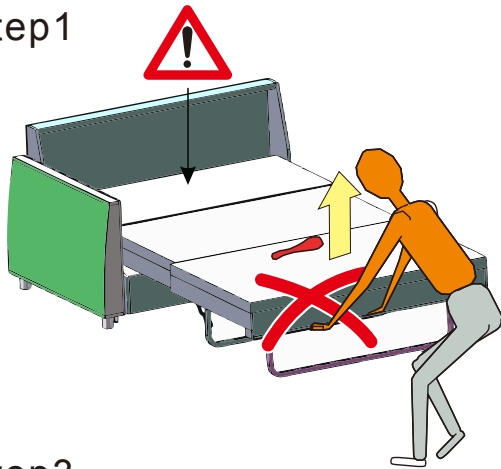

step2

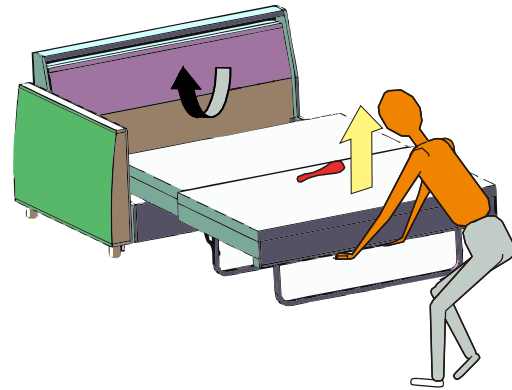

step3

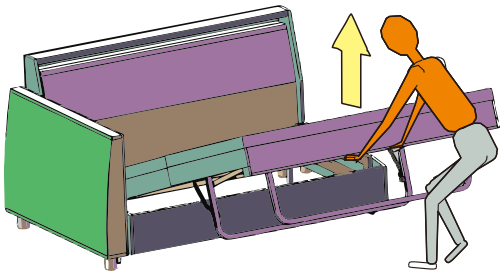

step4

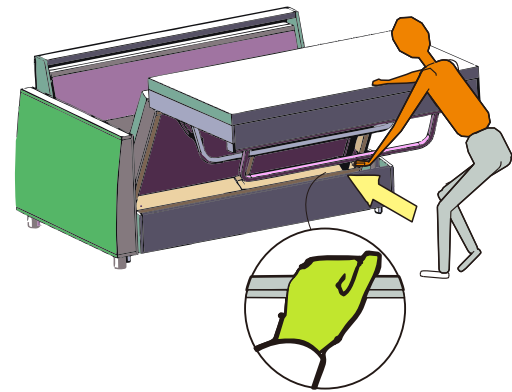

step5

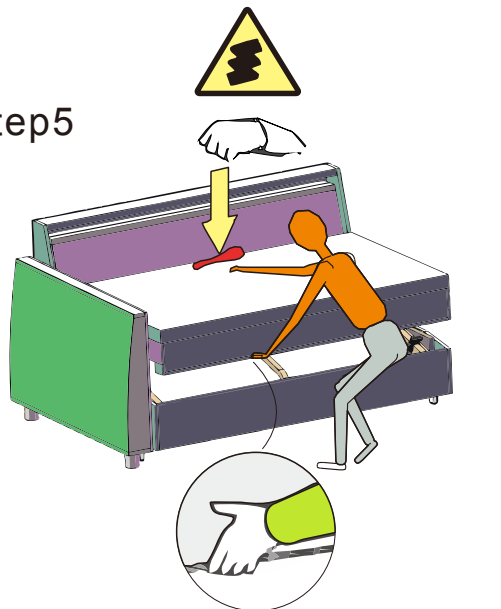

step6

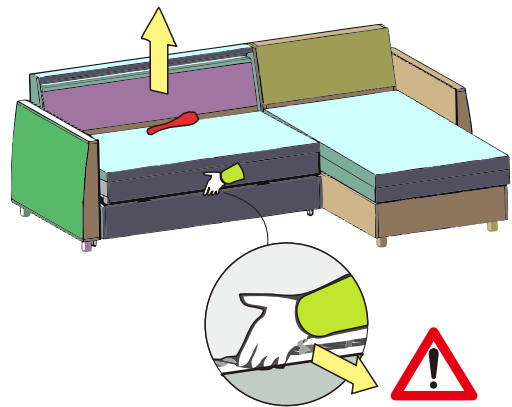

step7

