

# Assembly Instruction



Applicable product model :

CODA 2S

a=8  M8\*35mm

b=8   $\phi 8$

c=8   $\phi 8$

d=1  5mm

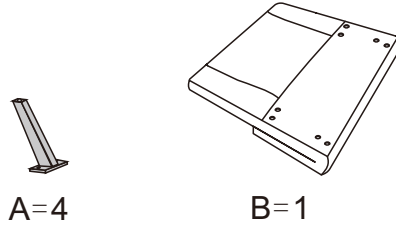

A=4

B=1

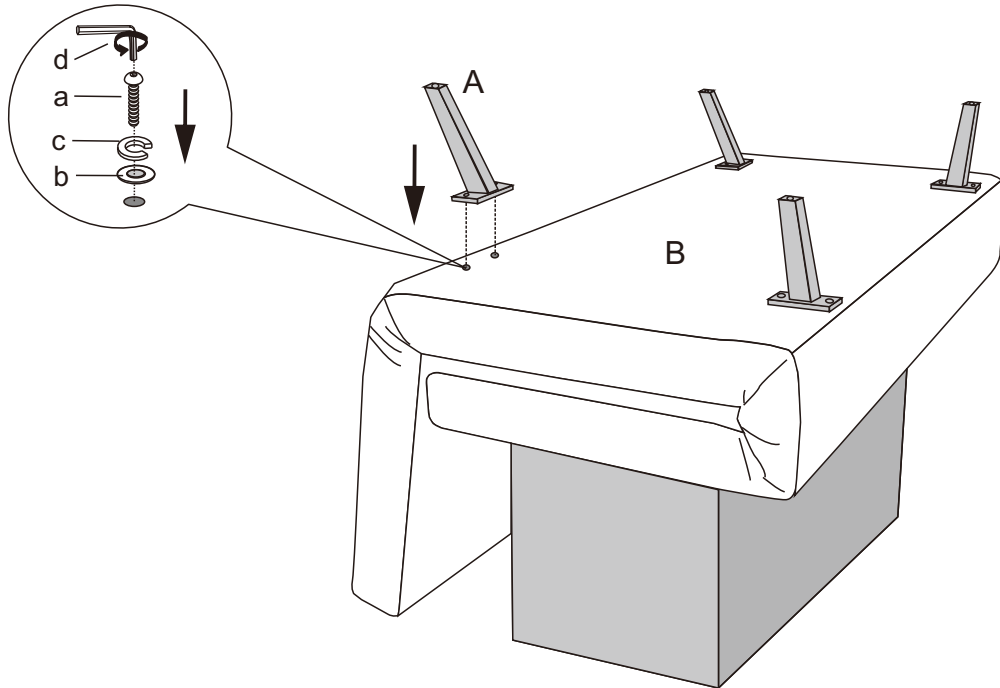

1

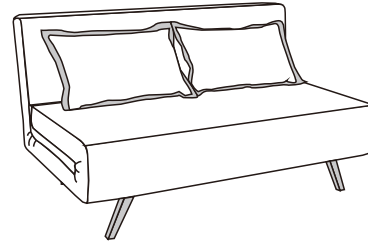

Do not use the lounge position without the legs fully extended

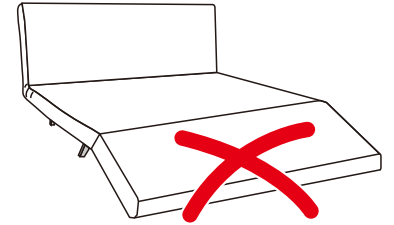

2

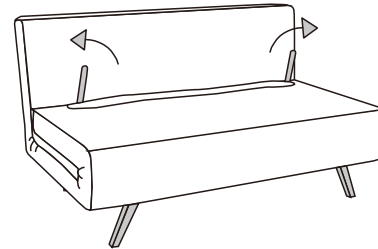

3

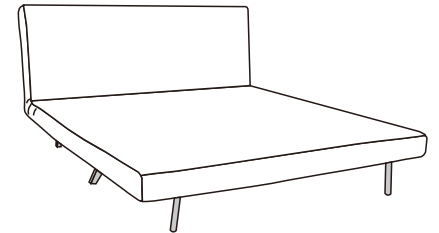

4

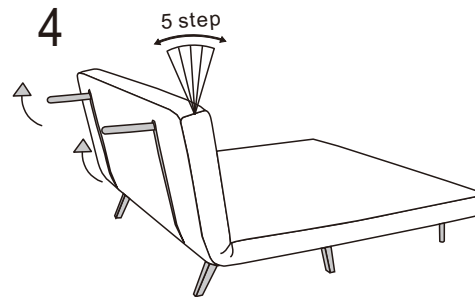

5

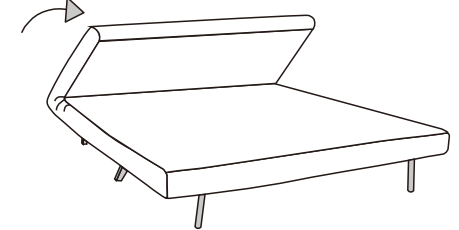

6

