

# Assembly Instruction

Applicable product model :

Bamton

M8x25

M6x30

Ø8



a=4

b=4

c=4

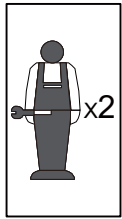
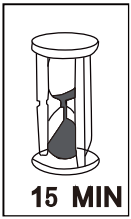

5mm

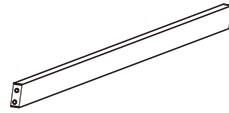

(1)=1

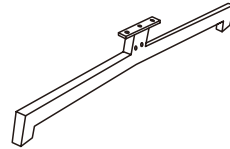

(2)=1

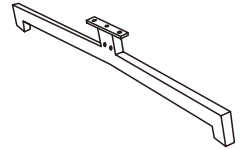

(3)=1

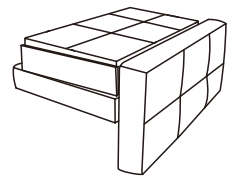
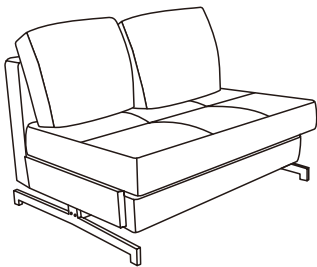

(4)=1

Step1

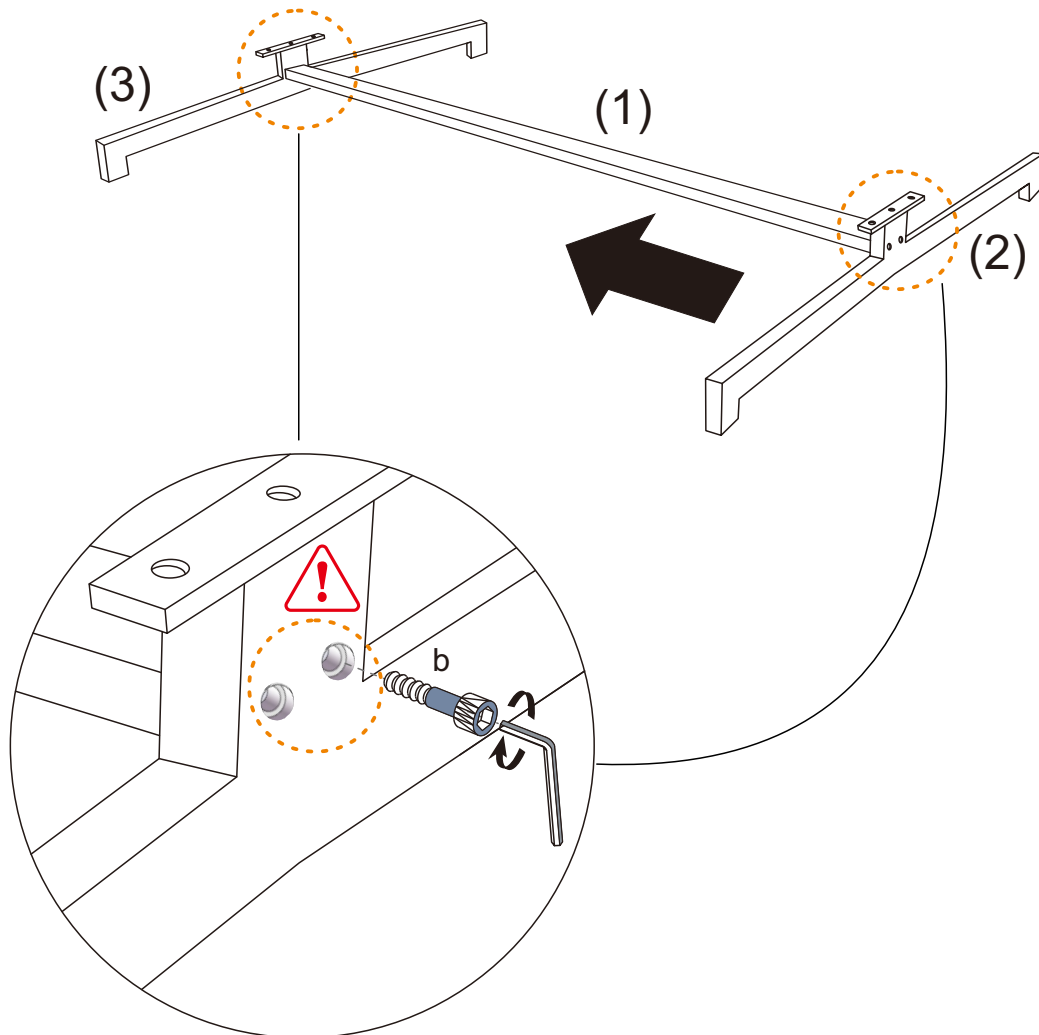

## Step2

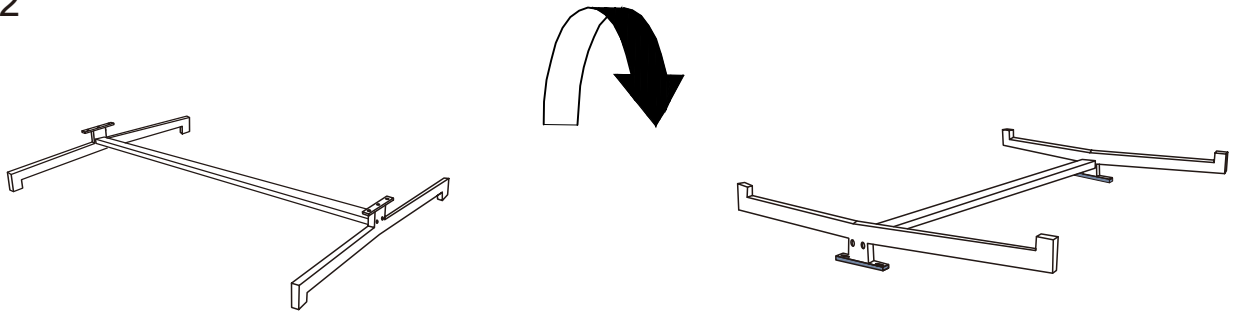

## Step3

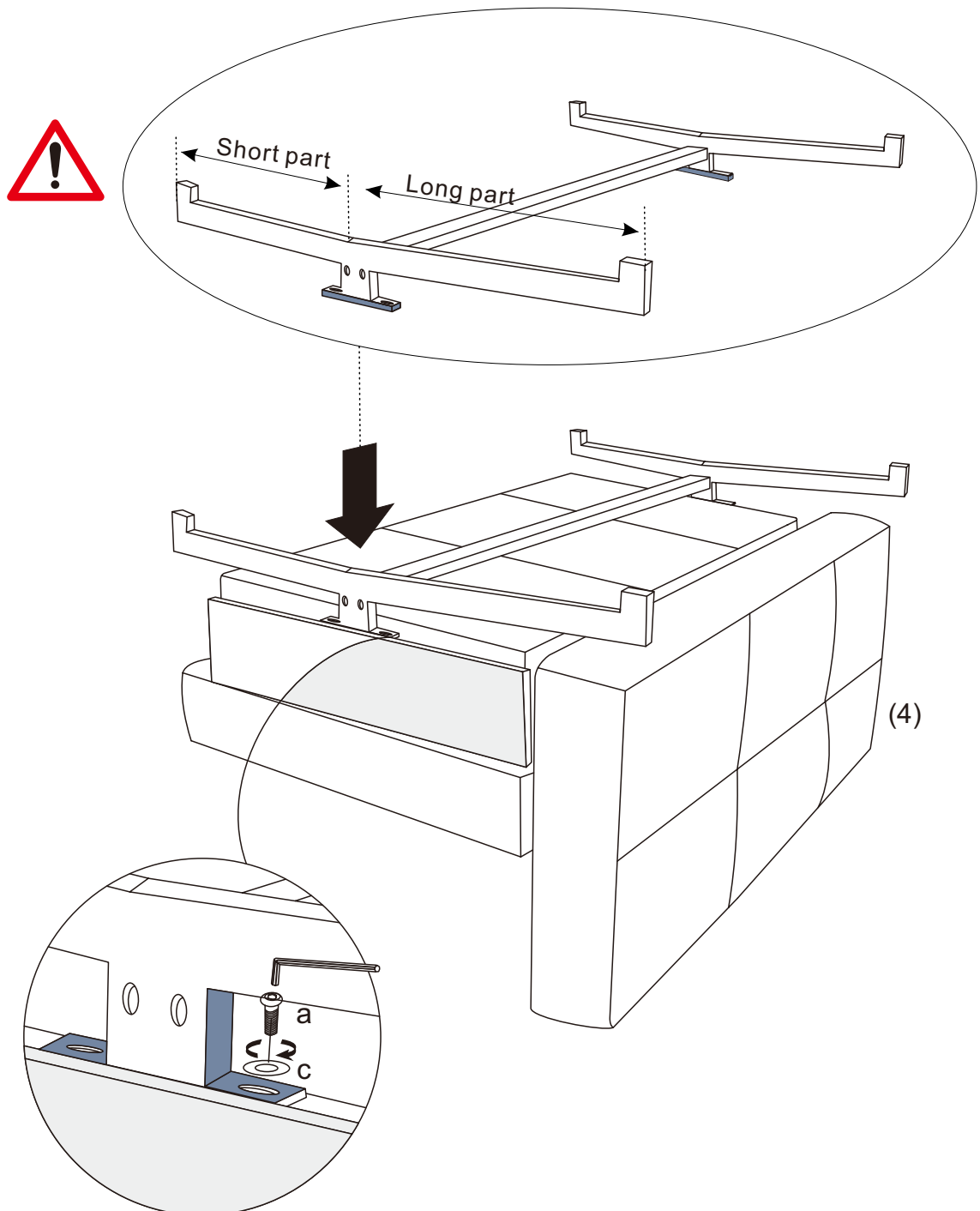

# Operation Manual

Applicable product model :

Bamton

1

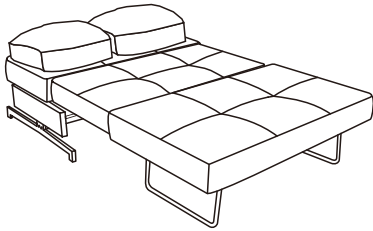

2

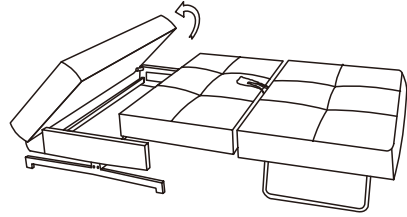

3

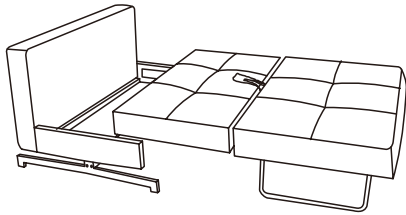

4

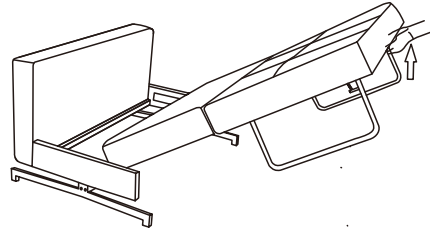

5

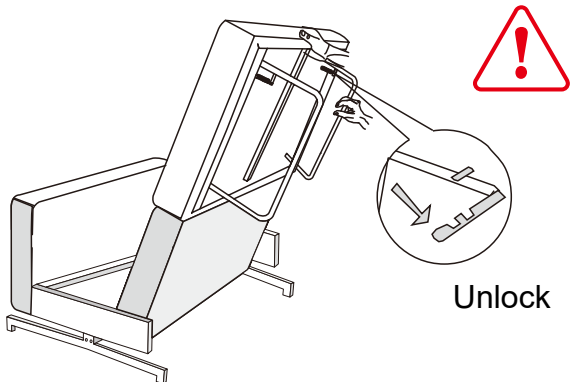

6

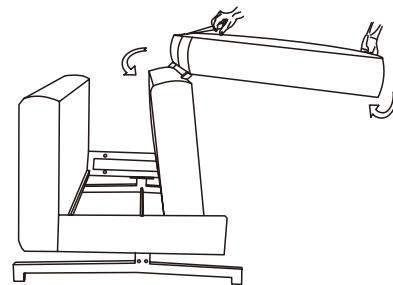

7

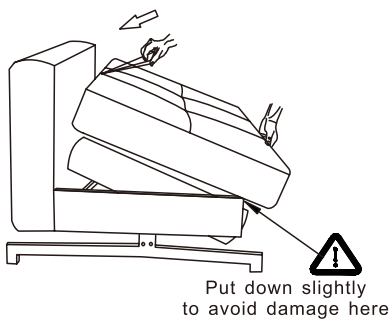

8

