

1013 / 1014 / 1015A / 1017 /  
1040 / 1040A / 1041 / 1041A

Beauty Trolley

Welcome to use our Beauty Trolley. A0  
Please read the user manual carefully before using the beds.

## 1、About This Manual

This manual shall only be used for the reference of operation of this particular model. If the manual is used for other purposes, SILVERFOX will not undertake any according consequences and responsibility. All information of this manual shall be protected by copyright and shall not be copied and translated in any part of this specification without the written consent of our company SILVERFOX.

## 2、Warning

- Do not stand on the product.
- Do not allow children play with the product.
- Do not place the equipment in damp places such as bathroom, do not expose to direct sunlight.
- Do not use this product in the places where you are painting/spraying paints or producing oxygen.
- People with physical impairment, tactile impairment, mental impairment, lack of experience, common sense, or children are not allowed to use this product, unless the person responsible for their personal safety is present to monitor and guide them.

## 3、Precautions











- Operators should use this product in strict accordance with the instructions, and save this manual for future reference.
- Comply with safe operating procedures, do not overload. Make sure the components of the product are in good condition, secure installation eliminate the unsafe factors.
- Please daily check and tighten the casters, drawers, metal frames and screws to prevent from any failure or issue due to loosen part.
- This product must not be used under faults. When abnormal phenomena or abnormal sounds are found, please check about it immediately. Use after problem solved.
- Operator should be familiar with the precautions described in each chapter of the product manual to ensure personal and product safety.
- Please place the equipment on a level ground.
- Please clean the glass, metal and plastic part with neutral solution.
- After each treatment, use a neutral reagent to remove the dust and stains on the leather and wood.

## 4、Assembly and Operation

1. Put the product to a proper location, according to the overall layout, the daylighting or artificial lightings and operation condition of the working environment. And keep it in the clean, dry and cool environment.
2. Open the packing carton to check if the bed is intact and whether the accessories or spares are complete. Please contact distributor or us if there's any problem.
3. Installation

This product graphic is only for display, the specific product structure please refer to the actual product.

### 1013 · Component





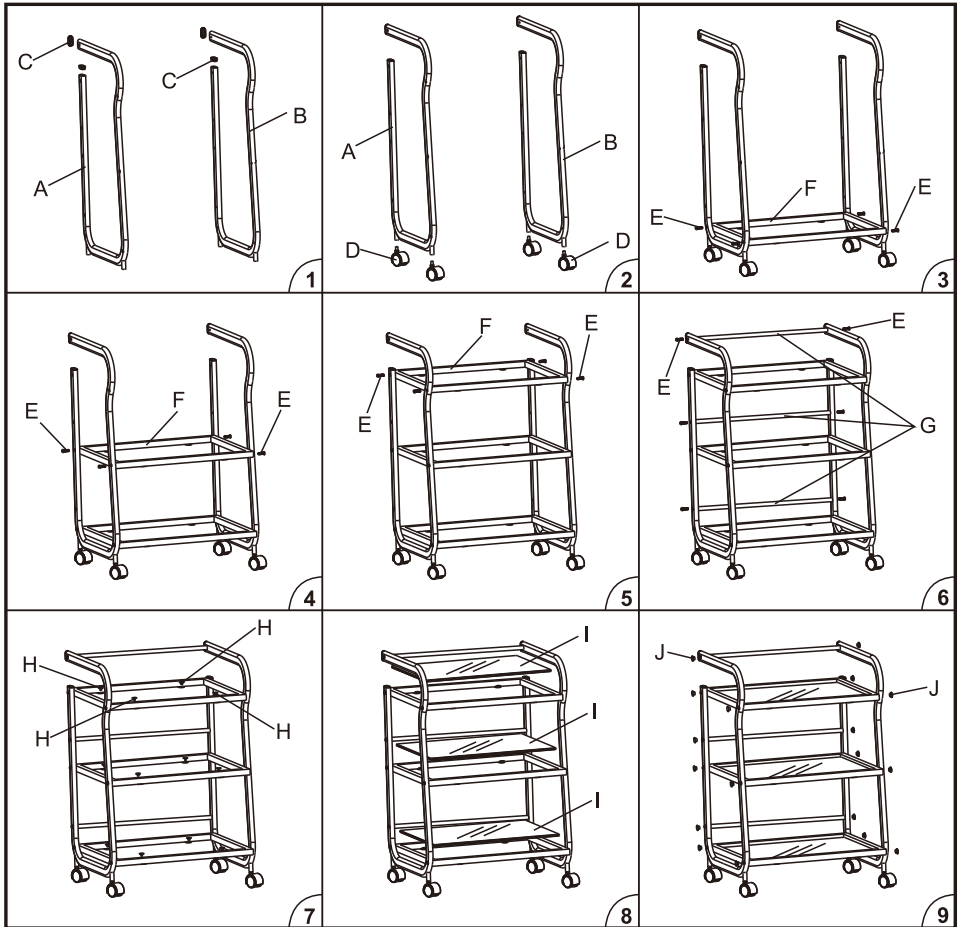



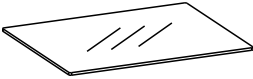

NO.	Name	Sample	Quantity
A	Metal frame for left		1
B	Metal frame for right		1
C	Accessories-1		4
D	Wheel		4
E	Screw (M6×20)		19
F	Accessories-2		3
G	Baluster		3
H	PVC Tray		13
I	Glass		3
J	Plastic Pin		18

# 1013 · Installation procedure









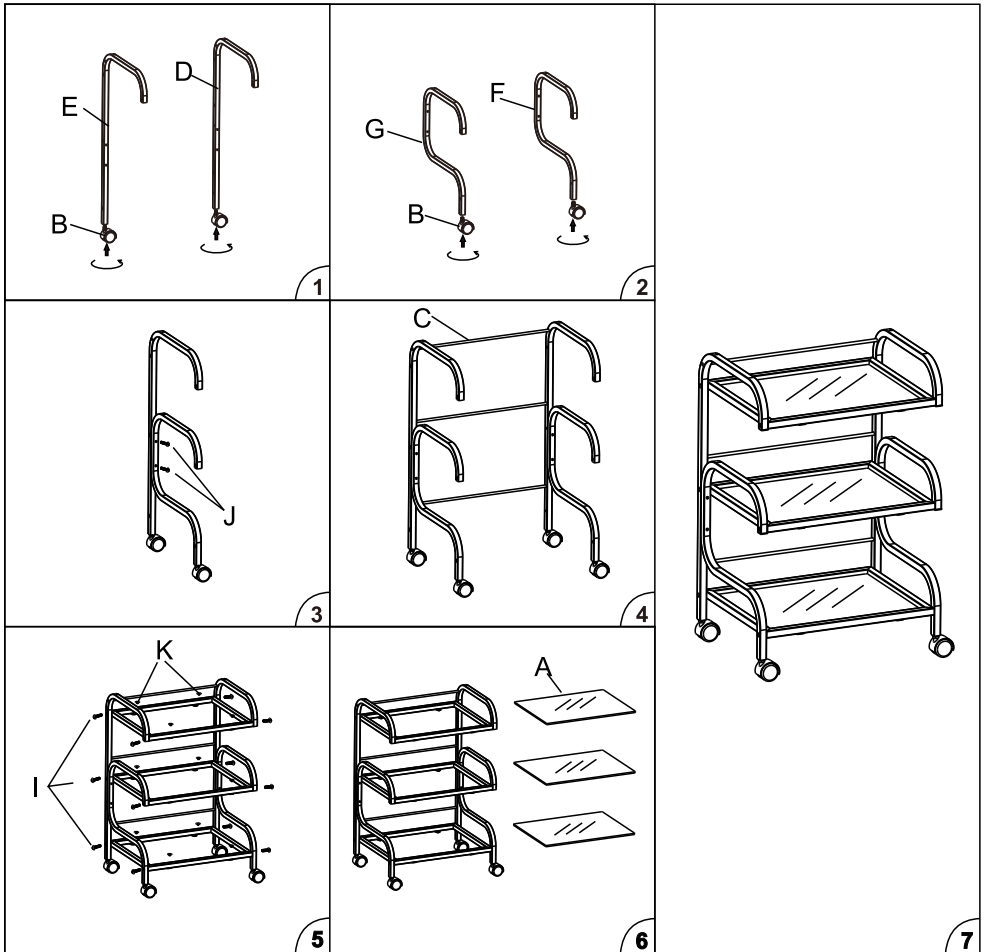

**1014 · Component**

NO.	Name	Sample	Quantity
A	Glass		3
B	Wheel		4
C	Baluster		3
D	Metal frame for left-1		1
E	Metal frame for right-1		1
F	Metal frame for left-2		1
G	Metal frame for right-2		1
H	Accessories-1		3
I	Screw (M6 × 20)		13
J	Screw (M6 × 35)		5
K	PVC Tray		13

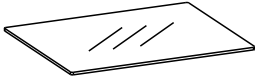
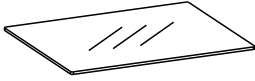
# 1014 · Installation procedure

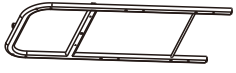
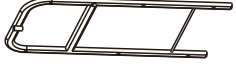







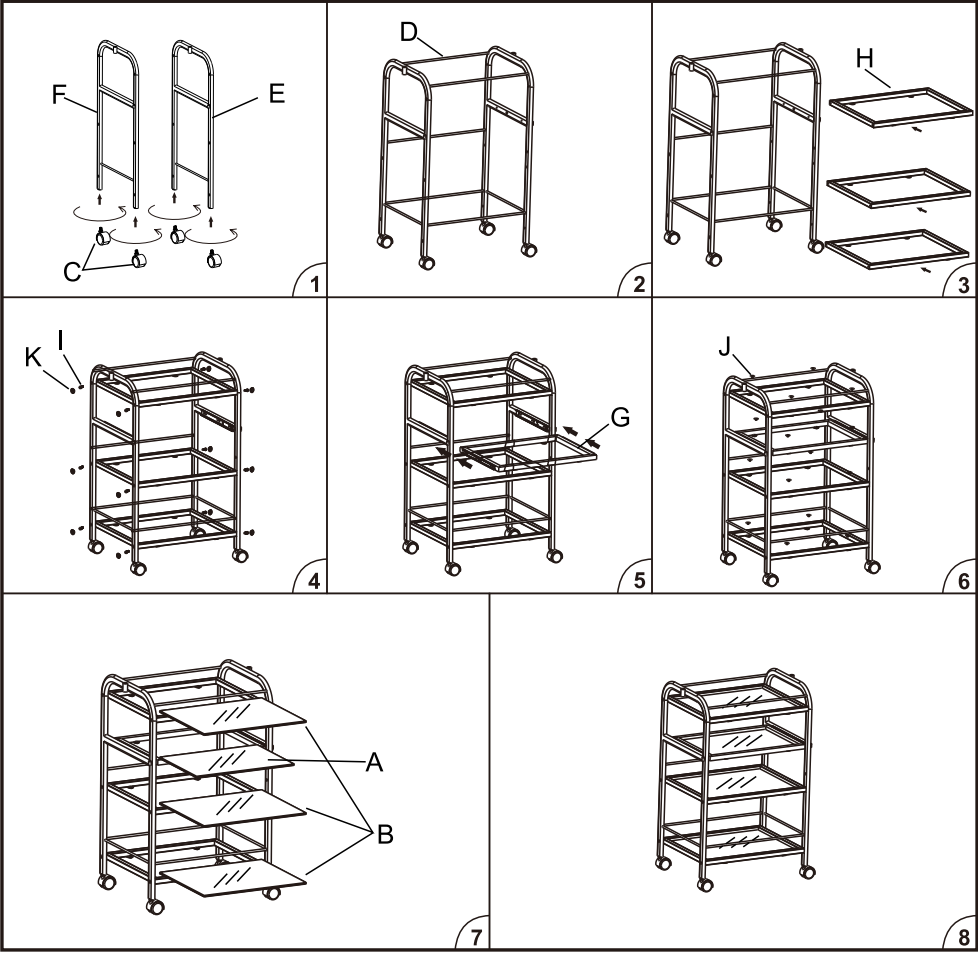

**1015A · Component**

NO.	Name	Sample	Quantity
A	Glass 604×296		1
B	Glass 624×356		3
C	Wheel		4
D	Baluster		5
E	Metal frame for left-1		1
F	Metal frame for right-1		1
G	Accessories-1 648×340		1
H	Accessories-1 668×400		3
I	Screw (M6×20)		12
J	PVC Tray		16

# 1015A · Installation procedure









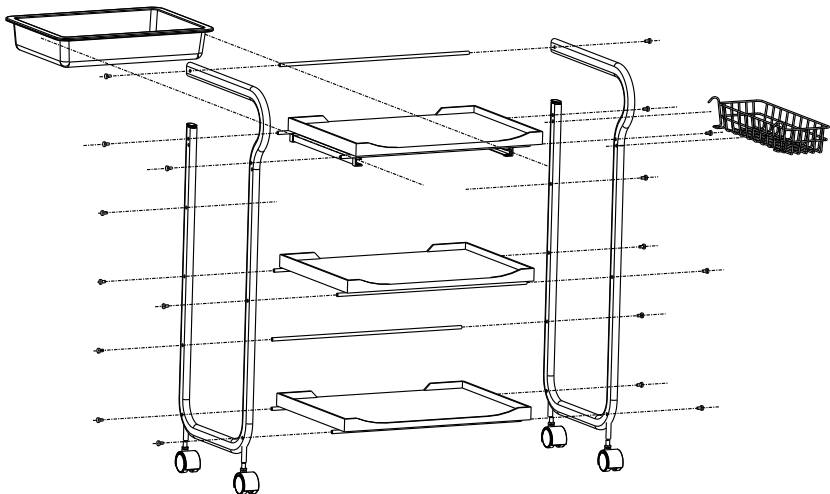

## 1017 · Component

NO.	Name	Sample	Quantity
A	Wheel		4
B	Baluster		3
C	Accessories-1		3
D	Accessories-2		1
E	Accessories-3		1
F	Metal frame for left		1
G	Metal frame for right		1
H	Screw (M6×8)		18
I	Screw (M6×12)		2

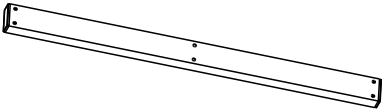
## 1017 · Installation procedure









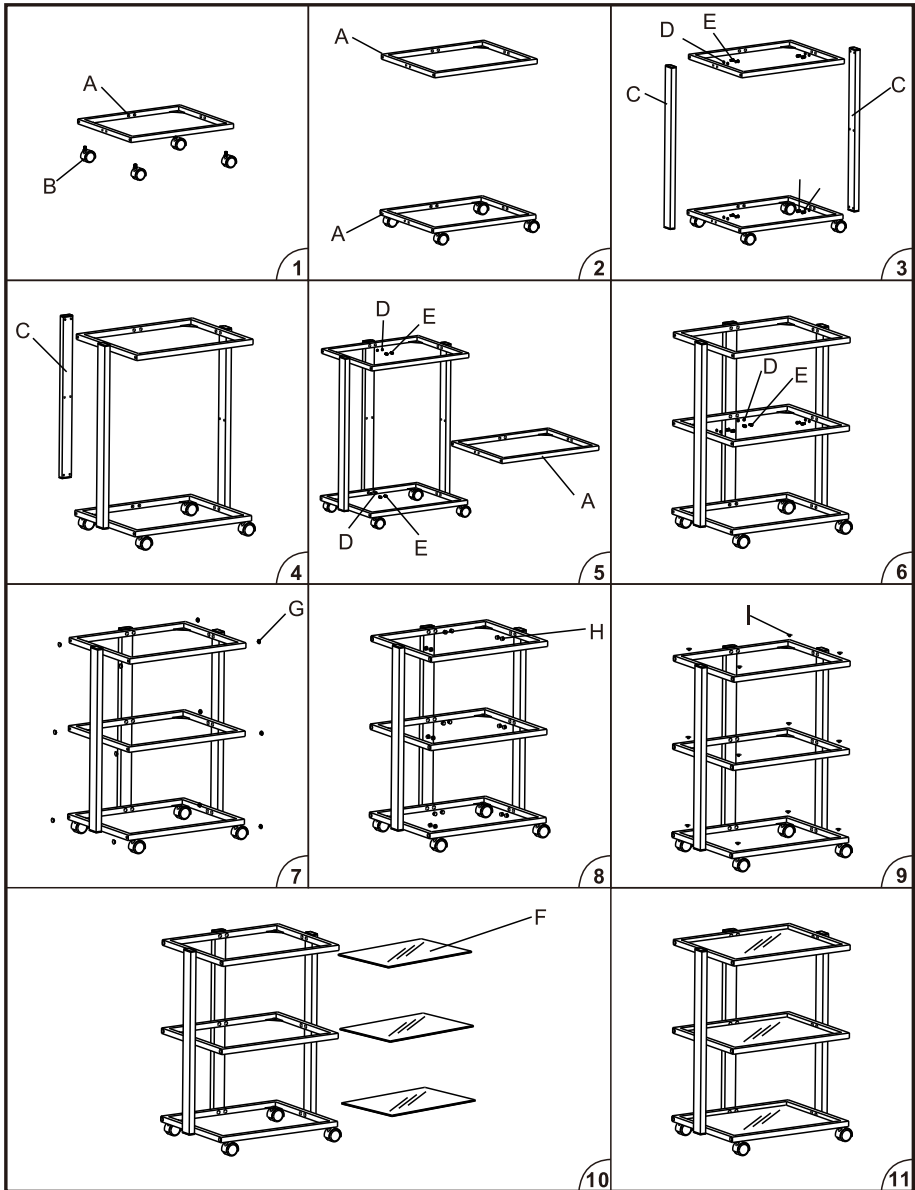

## 1040 · Component

NO.	Name	Sample	Quantity
A	Accessories-1		3
B	Wheel		4
C	Accessories-2		3
D	Gasket ( $\phi$ 6)		18
E	Screw (M6 $\times$ 12)		19
F	Glass		3
G	Block-1		12
H	Block-2		24
I	PVC Tray		13

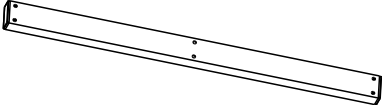
# 1040 · Installation procedure



### 1040A · Component

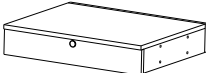





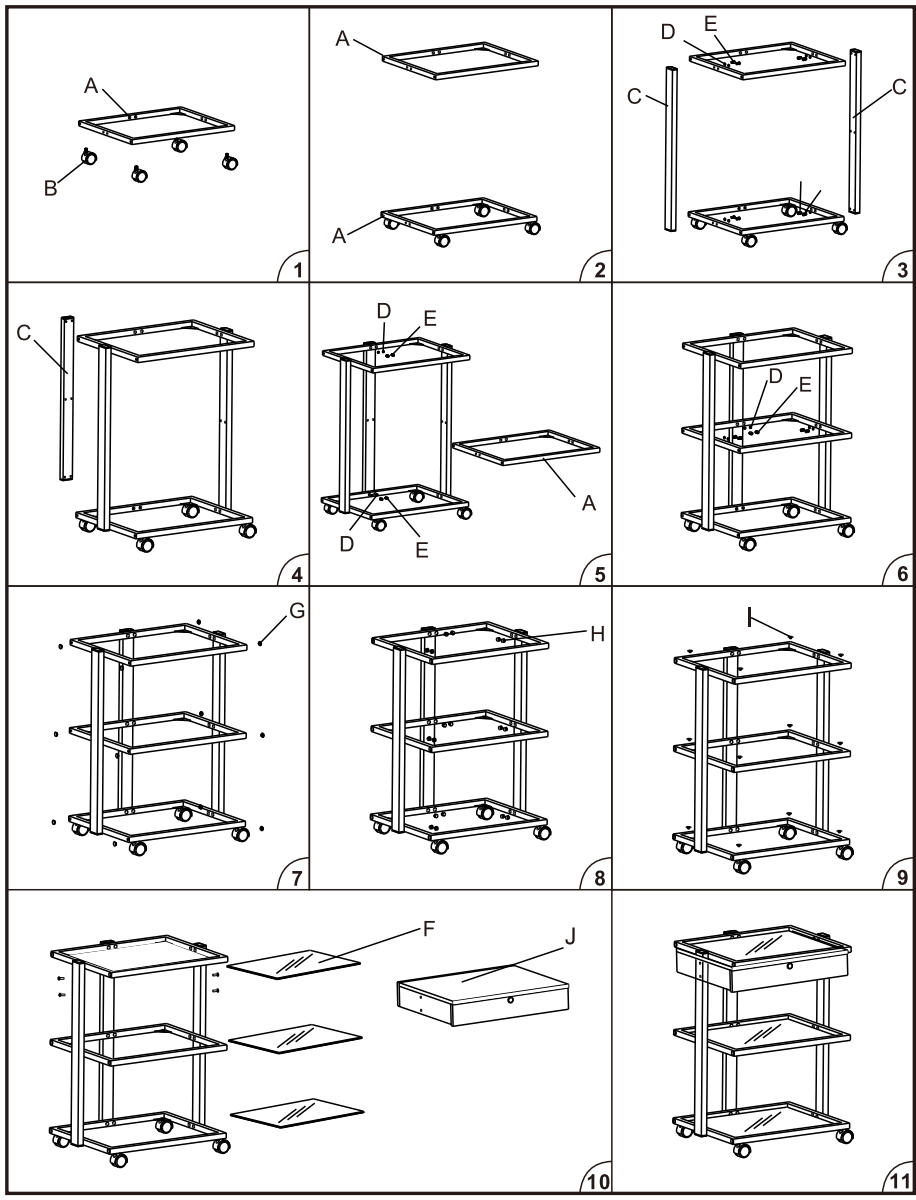

NO.	Name	Sample	Quantity
A	Accessories-1		3
B	Wheel		4
C	Accessories-2		3
D	Gasket ( $\phi$ 6)		25
E	Screw (M6 $\times$ 12)		19
F	Glass		3
G	Block-1		12
H	Block-2		24
I	PVC Tray		13
J	Accessories-3		1

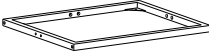

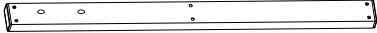
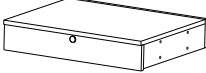
# 1040A · Installation procedure









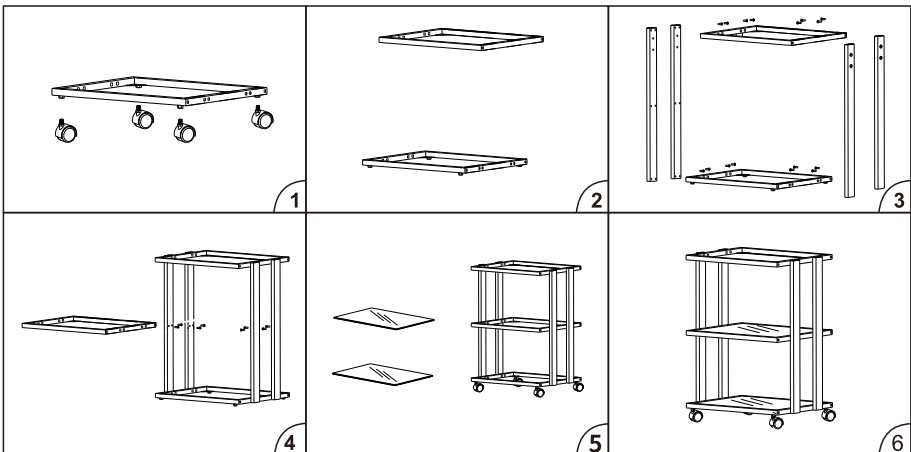

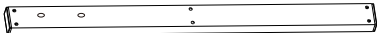
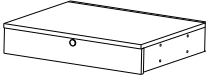

## 1041 · Component

NO.	Name	Sample	Quantity
A	Accessories-1		2
	Accessories-2		1
B	Wheel		4
C	Accessories-3		4
	Accessories-4		1
D	Gasket ( $\phi$ 6)		25
E	Screw (M6×12)		25
F	Glass		3
G	Block		25
H	PVC Tray		16

## 1041 · Installation procedure



### 1041A · Component

NO.	Name	Sample	Quantity
A	Accessories-1		2
	Accessories-2		1
B	Wheel		4
C	Accessories-3		4
	Accessories-4		1
D	Gasket (Ø 6)		25
E	Screw (M6 x 12)		25
F	Screw (M6 x 16)		8
G	Glass		3
H	Block-1		12
I	Block-2		24
J	PVC Tray		13

## 1041A · Installation procedure

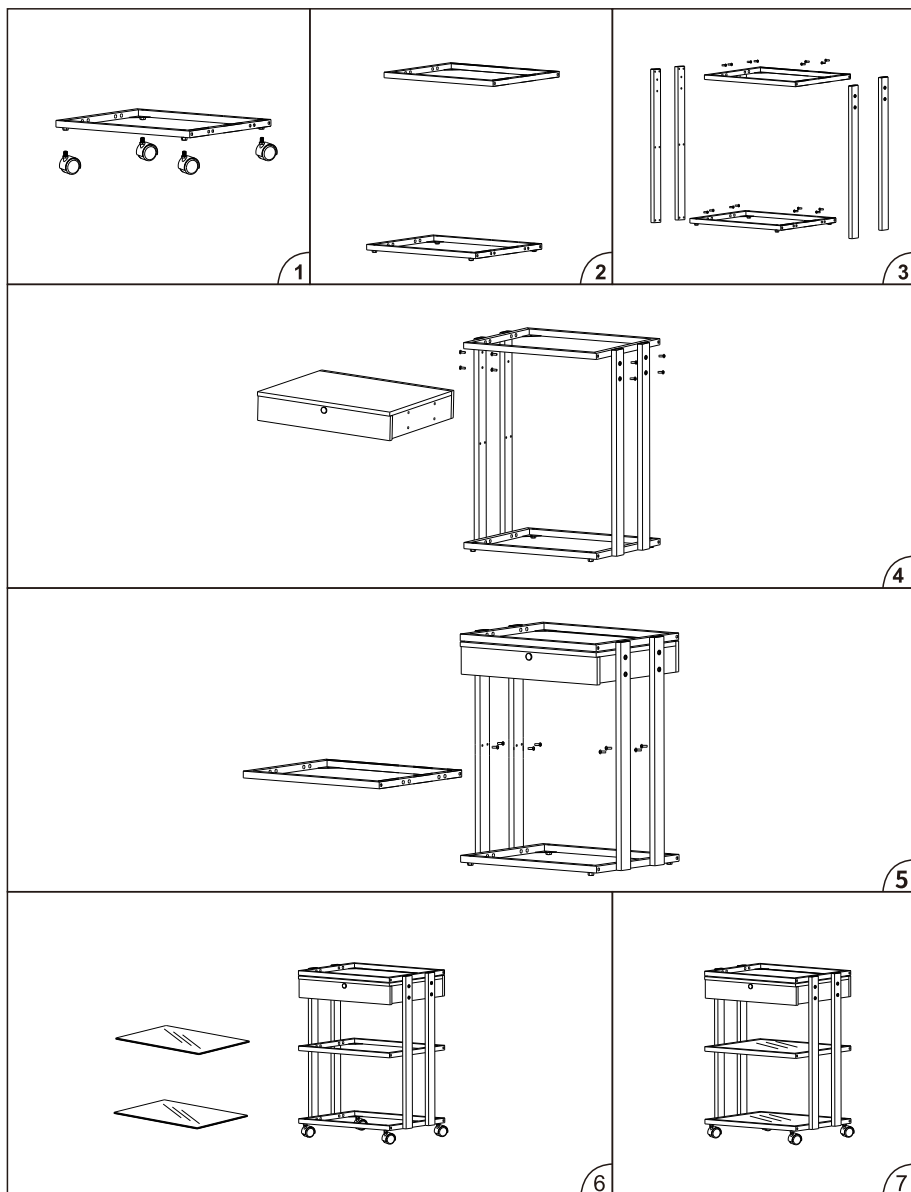

## 5、Technical Parameters

Lifting Rated Load	30 kg
Package Size	770×455×155mm (1013) 850×440×140mm (1014) 880×430×200mm (1015A) 850×370×165mm (1017) 760×455×150mm (1040 / 1041) 995×655×175mm (1040A / 1041A)
Net Weight	14kg(1013) , 13.5kg (1014) , 22.5kg (1015A) , 5.6kg (1017) , 16kg (1040 / 1041) , 24kg (1040A / 1041A)
Gross Weight	16kg(1013) , 14.5kg (1014) , 525kg (1015A) , 6.9kg (1017) , 18.5kg (1040 / 1041) , 28.5kg (1040A / 1041A)

**1013**

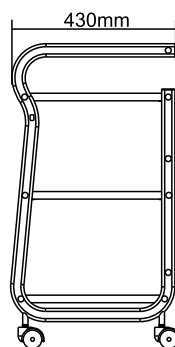
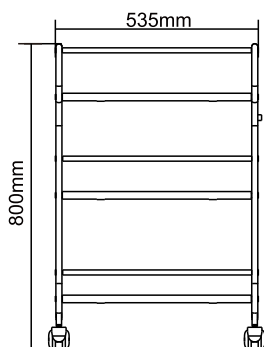

**1014**

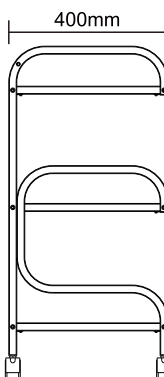
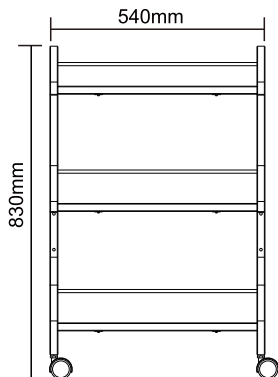

1015A

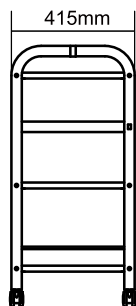
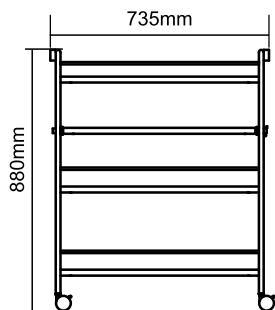

1017

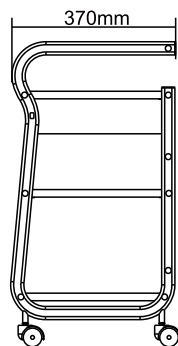
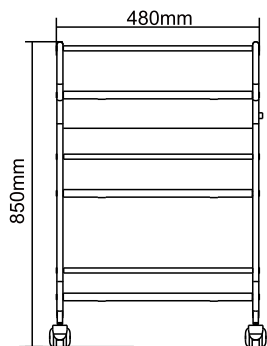

1040

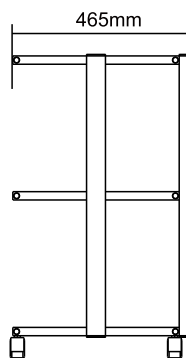
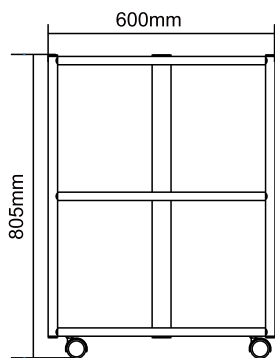

1040A

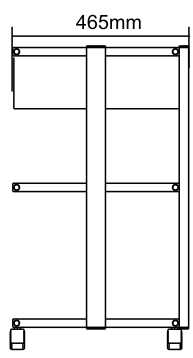
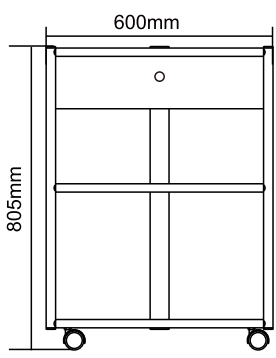

1041

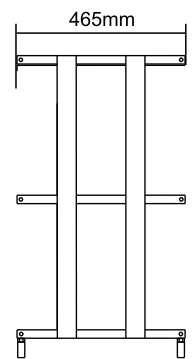
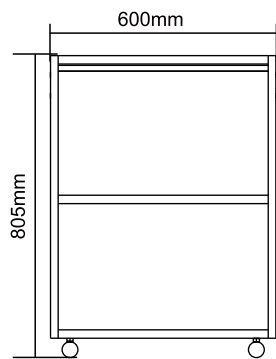

1041A

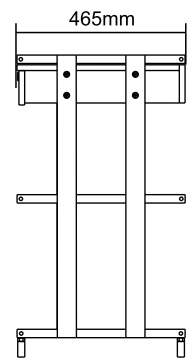
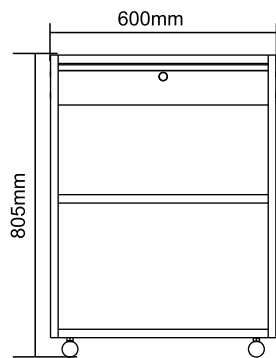

## 6. Maintenance

If there is grease, please wipe the surface with clean water and neutral reagent, and use a soft cloth to remove dust and stains. It is forbidden to use alcohol, strong acid, strong alkali and other solvents to prevent premature deterioration of plastic parts.

## 7. Troubleshooting

Not working properly	Casters cannot rotate or move.	Replace the caster.
----------------------	--------------------------------	---------------------

If problem is still not solved after above operation, please contact maintenance center or supplier to solve it.



Do not dispose of old or defective appliances in domestic garbage; this should only be done through public collection points.

▲ Please check the product specification before use. This manual is for reference only. Specifications are subject to change without prior notice.