

2241 / 2241C

SPA & Wellness Equipment

Welcome to use our SPA & Wellness Equipment.A0
Please read the user manual carefully before using the beds.

1、About This Manual

This manual shall only be used for the reference of operation of this particular model. If the manual is used for other purposes, SILVERFOX will not undertake any according consequences and responsibility. All information of this manual shall be protected by copyright and shall not be copied and translated in any part of this specification without the written consent of our company SILVERFOX.

2、Warning

- Power supply must be cut off when changing electrical components or maintaining and cleaning machines.
- The plug must be plugged into an outlet that is properly installed and grounded, to prevent the risk of fire and electric shock.
- Do not stand on this equipment.
- Do not allow children to play with and place the equipment in a place where children can touch; Please adjust the backrest to the highest position when you leave.
- Please do not place the equipment in wet places such as bathroom to avoid electric shock or other failure; Also keep the controllers away from water.
- Please do not place and operate the equipment in places where is painting/coating or supplying oxygen.
- Unless being monitored or instructed by personnel who can be responsible for their personal safety, the people who have physical obstacles, tactile disorders, mental disorders, lack of experience, common sense or children, are not allowed to use the equipment.
- Please contact distributor, service center or related personal with appropriate skill and experience for repairing if the plug is damaged, in case of any danger.
- Please make sure there is no accessible thing within the stroke during any operation of the beds.
- Operation should be processed by trained professionals.

3、Precautions

- The equipment should be used by an experienced person who must be familiar with the product structure, performance and instructions. And make the regular maintenance work.
- Read this manual carefully before installation, operation and adjustment. And please keep it well.
- This product shall not be used for single side or single point loading work.
- Comply with safety operation rules, do not overload the use of products, to ensure that the product safety protection equipment is complete and reliable, eliminates unsafe factors on time.
- Tighten bolts and nuts regularly to avoid failure caused by loose, sliding, vibration and falling parts.
- During the maintenance, the operator shall not disassemble any parts of the bed at will.
- This product is not allowed to operate when it's with fault. If abnormal phenomenon or abnormal sound is found, it must be stopped for inspection immediately, and work can be resumed after troubleshooting.
- The operator must be familiar with the precautions described in each section of the manual to ensure the safety of person and product.
- This electric beauty bed is equipped with a three-wire power cord. The power cord must be plugged into a three-hole outlet which is properly installed and grounded. This is not only to prevent the risk of electric shock, but also ensure bed work properly.
- Please operate the equipment strictly accordance with the warning label pasted to the products.
- While controlling the lifting of the whole bed, the button must be pressed continuously until the bed in a suitable position.
- Please pay attention that the continuous working times should be Max. 2Min. ON : 18Min. OFF, when operating the motor.
- Maintenance should be processed by trained professionals.
- After each treatment, please use neutral reagent to clear the dust, stains on leather or on wood pieces.
- When adjusting the backrest, seat cushion, or lifting of the whole bed by hand controller or installed foot controller, please keep your hands, feet and head away from the position.
(Please see right picture)

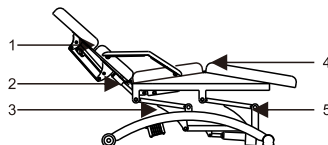

4、Applicable Range

These products are suitable for beauty and massage treatment.

5、Installation

1. Put the bed to a proper location, according to the overall layout, the daylighting or artificial lightings and operation condition of the salon's or the home. And keep it in the clean, dry and cool environment.
2. Open the packing carton to check if the bed is intact and whether the accessories or spares are complete. Please contact distributor or us if there's any problem.
3. Installation
Please ensure the bed is placed on a firm and flat ground, so as to prevent any accident.
4. Connect the plug with power supply properly. (Details as shown below)

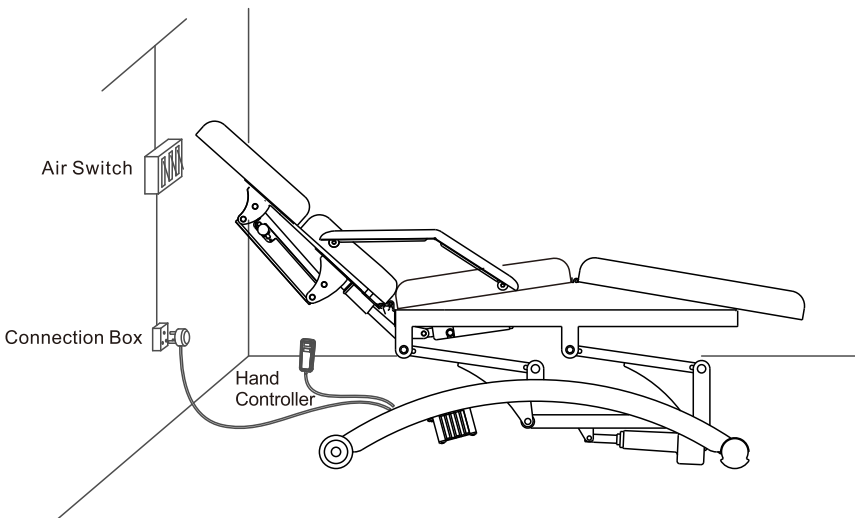

6. Structure of Product

- This product consists of control box, motor, hardware, plastic parts and leather. Among them, the control box is controlling the operation of the motor and the hand controller.
- This product includes angle adjustment of the backrest, seat cushion and lifting adjustment of the whole bed which is an overall and integral structure.
(Details as shown below)

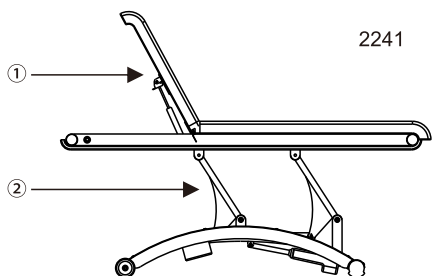

- ① angle adjustment of the backrest (manual adjustment)
② lifting adjustment of the whole bed

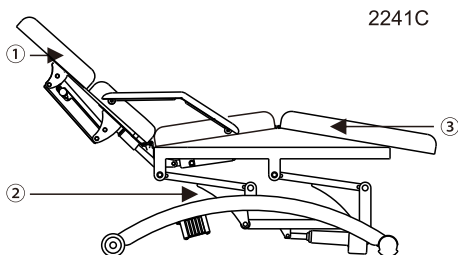

- ① angle adjustment of the backrest
② lifting adjustment of the whole bed
③ angle adjustment of the seat cushion

7. Operation Instruction

2241

1. Standard Configuration (Hand Controller)

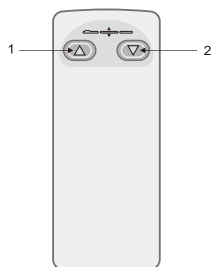

2. Optional Configuration (Foot Controller)

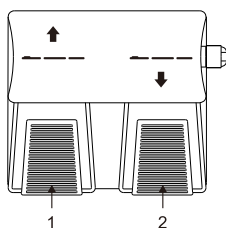

	Description	Operation
1	Whole bed moves up	The bed goes up smoothly by pressing the button
2	Whole bed moves down	The bed goes down smoothly by pressing the button

2241C

1. Standard Configuration
(Hand Controller)

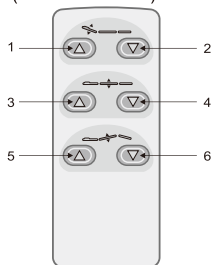

2. Optional Configuration
(Hand Controller for Heating system)

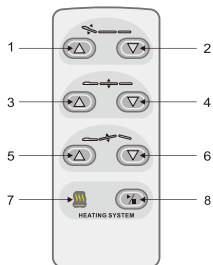

3. Optional Configuration
(Foot Controller)

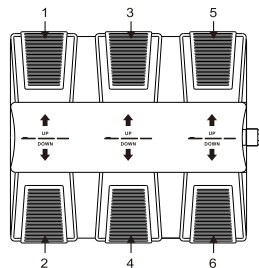

No.	Description	Operation
1	Backrest moves up	Backrest goes up smoothly by pressing the button.
2	Backrest moves down	Backrest goes down smoothly by pressing the button
3	Whole bed moves up	The bed goes up smoothly by pressing the button
4	Whole bed moves down	The bed goes down smoothly by pressing the button
5	Seat inclination up	Seat inclining smoothly by pressing the button
6	Seat inclination down	Seat goes flat smoothly by pressing the button
7	Indicator light of heating function(Optional)	Pressing the button, the light is on, the heating function works; pressing the button again, the light is off, the heating function stops.
8	Heating (Option)	

Notes:

- 1.The memory position setting is only available for the models with memory function.
- 2.The heating function is only available for the models with heating function.
- 3.Different hand controllers should be chosen according to different configuration.

8、Technical Parameters

Power	AC 100-120V or AC 220-240V or AC 100-240V , 50/60Hz
Maximum Power	300W
Environment Temperature	0°C~+40°C
Relative Humidity	30%~90%
Lifting Rated Load	175 kg

2241

Package Size	2020×750×600mm
Net Weight	71kg
Gross Weight	86kg

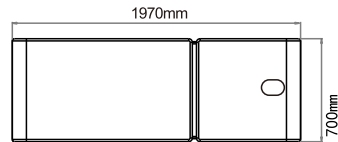
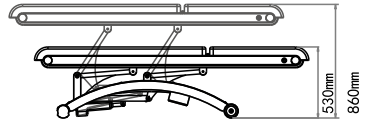
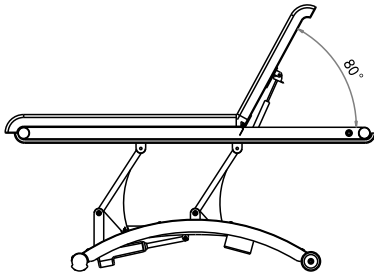

2241C

Package Size	2080×790×610mm
Net Weight	77kg
Gross Weight	92kg

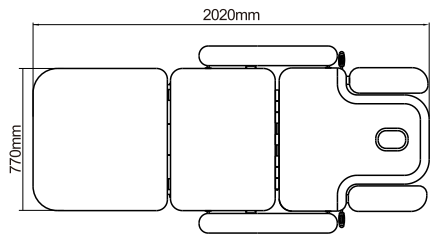
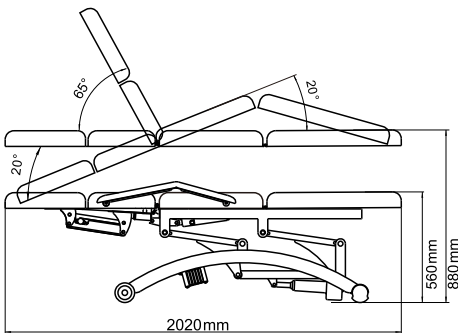

9. Maintenance

1. After every treatment, please only use neutral solution to clear the dust, stains on leather, metal part or plastic cover. Disinfecting solution like alcohol, acid or alkaline solution are forbidden. This is to prevent the lifetime of leather and plastic cover from being shorten.
2. Please lubricate the moving parts regularly (once a year)

10. Circuit System Connection Diagram

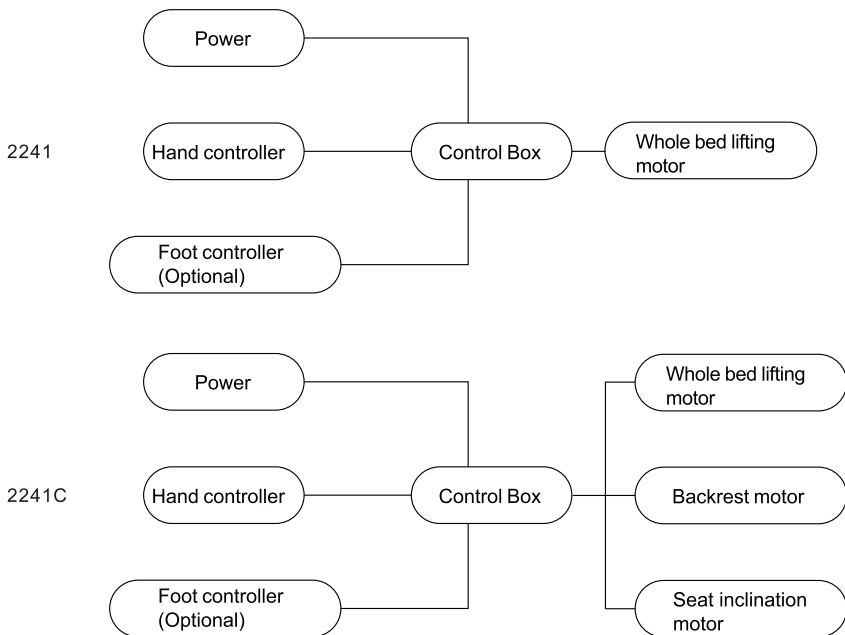

11、 Troubleshooting

The Fault Phenomenon	Reason	Solution
Can't move up or down normally	1. The power cord is unconnected or not plugged well.	1. Connect the power cord or plug it well.
	2. Poor quality of the hand controller or foot controller.	2. Replace the hand controller or foot controller.
	3. Poor quality of the control box.	3. Please contact maintenance center or supplier for troubleshooting.
	4. Repture of motor tail.	
	5. Motor was damaged.	
Abnormal Sound	1. The rotating parts are short of lubricating oil.	1. Add lubricating oil.
	2. Rotating positions (such as hinge, POM sets) are short of lubricating oil.	2. Add lubricating oil.
	3. Motor quality problems.	3. Replace the motor.

If problem is still not solved after above operations, please contact maintenance center or supplier to solve it.



Do not dispose of old or defective appliances in domestic garbage; this should only be done through public collection points.

▲ Please check the product specification before use. This manual is for reference only. Specifications are subject to change without prior notice.