



ETOP-4770 Manual

Ice & Snow Melting Controller
for Outdoor Conditions

Contents

1. Introduction	3	5. Control	27
1.1. Product Program	4	6. Daily Use	28
1.2. System Applications	5	6.2. System On	29
2. Important Safety Instructions	6	6.3. Low temperature	30
3. Installation	7	6.4. Heating	31
3.1. Mounting the Controller	8	6.5. Forced Heat	32
3.2. Terminal Connections	9	6.6. Error	33
3.2.1. Power Supply and Load	10	6.7. Maintenance	34
3.2.1.1. Wiring Single Phase + Neutral	11	7. Test System	35
3.2.1.2. Wiring Single Phase Two Wire	12	7.1. Test Mode LED Overview (continued)	36
3.2.1.3. Wiring 3-Phase Delta	13	7.2. Test Mode	37
3.2.1.4. Wiring 3-Phase + Neutral Star	14	7.2. Test Mode (continued)	38
3.2.2. Sensors and Remote Control	15	8. Technical Specifications	39
3.3. External Sensors and Remote Controller	16	8.2. Controller - ETOP-4770	40
3.3.1. Ground Sensor - ETOG	17	8.2. Controller - ETOP-4770 (continued)	41
3.3.2. Gutter Sensor - ETOR	18	8.3. Ground Sensor - ETOG	42
3.3.3. Outdoor Sensor - ETF-744/99	19	8.4. Gutter Sensor - ETOR	43
3.3.4. Sensor Cable Recommendations	20	8.5. Outdoor Sensor - ETF-744/99	44
3.4. Connecting the Remote Controller (optional)	21	8.6. Remote Control Panel - ETOP-R	45
4. Setup System	22	9. Contact Information	46
4.1. Set After-Run (continued)	23		
4.2. Set Type of Application	24		
4.3. Set Moisture Sensitivity	25		
4.4. Recommended Settings	26		

1. Introduction

The ETOP controller is designed for outdoor installation, high-power control and easy operation.

Key parameters:

- NEMA 4X /IP 66
- -55°F / -50°C
- 90 A
- Magnetic control
- Remote control

Snow and Ice detection system for the control of electrical heating cable. The controller monitors both temperature and moisture, and the heating system is only activated if there is a possibility of snow or ice.

Used for ground, gutters and roofs, downpipe, loading ramps, balconies, ramps for driving and walking, antennas and railroad track switches.

The controller can be used together with the ETOG ground sensor or ETOR gutter sensor with temperature sensor ETF-744/99.

The controller can also be controlled remotely from the ETOP-R control panel placed inside the building.

OJ Winterline®

1.1. Product Program

Controller Program

ETOP-4770	Outdoor controller for ice and snow melting
ETOP-R	Remote control panel for the ETOP

Sensors and Accessories

ETOG-55	Ground sensor for detecting temperature and moisture
ETOG-56/ETOK-1	Embedded ground sensor for detecting temperature and moisture
ETOR-55	Gutter sensor for detecting moisture
ETF-744/99	Outdoor sensor for detecting temperature

1.2. System Applications

The controller uses readings from temperature and moisture sensors to ensure optimal economic power consumption when keeping outdoor areas and roofs free of ice and snow. The moisture sensor is installed on the surface of the outdoor area or placed in the gutter. As soon as moisture is detected, the controller activates the snow-melting system. Once the sensor has dried out, the thermostat immediately switches to after-run, and the system will continue to provide heat for a predetermined amount of time.

It is very important to choose the correct application, to make sure you have the correct type of sensors for your system.

Gutters, roofs, downpipes or antennas

Use the controller ETOP-4770 together with the gutter sensor ETOR-55 and the outdoor sensor ETF-744/99. The ETOR sensor is designed for installation in gutters, downpipes, etc. The ETOR sensor detects moisture, while the ETF sensor measures temperature.

Small ground areas (such as parking areas), loading ramps, balconies, ramps or railroad tracks

Use the controller ETOP-4770 together with the ground sensor ETOG and/or the outdoor sensor ETF-744/99 (optional).

The ETOG sensor is designed for embedding in the surface of the outdoor area. ETOG sensors measure ground temperature and moisture. The ETF-744/99 sensor can be used for measuring rapid drops in temperature.

2. Important Safety Instructions



WARNINGS

- To avoid electric shock, disconnect the heating system power supply at the main electrical panel before carrying out any work on this thermostat and the associated components.
- Installation must be carried out by qualified personnel in accordance with appropriate regulations (where required by law).
- The installation must comply with the national and/or local electrical codes.



CAUTIONS

- This instruction must be observed, otherwise the liability of the manufacturer shall be voided.
- Any changes or modifications made to this thermostat shall void the liability of the manufacturer.
- When heat is not required, the maximum product lifetime is not achieved if the product is turned off, but rather if the product is set at the lowest possible set point/frost protection.



NOTICE

- The language used in the original documentation is English. Other language versions are a translation of the original documentation.
- The manufacturer cannot be held liable for any errors in the documentation. The manufacturer reserves the right to make alterations without prior notice.
- Content may vary due to alternative software and/or configurations.

ENVIRONMENT AND RECYCLING

Protect the environment by disposing of the package in compliance with local regulations for waste processing.

RECYCLING OF OBSOLETE APPLIANCES

Equipment containing electrical components should not be disposed of together with domestic waste. It must be separately collected with electrical and electronic waste in accordance with current local regulations.

OJ Winterline®

3. Installation

The controller is for wall mounting and can be placed outdoors.

3.1. Mounting the Controller

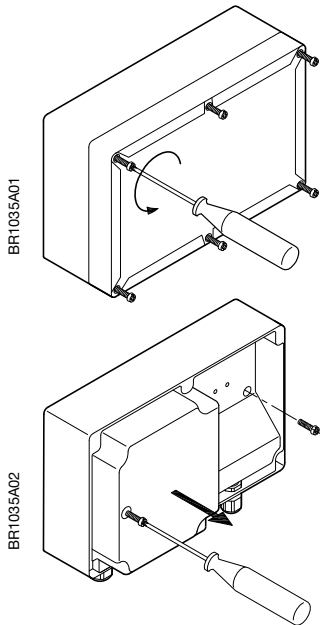

1. Open the controller/ unscrew the clear lid.
2. Use the drilling template included in the Quick Guide to mark the mounting holes.
3. Mount the controller on a straight wall (screws not included). Use 6 screws maximum 4 mm / size 7.
4. Open the controller and remove the inner cover to access the terminals.
5. Remove the plugs in the cable fittings used.
6. Mount the cables through the cable fittings and tighten the fittings.

Important! Use the correct cable sizes, and make sure the cable fittings are tight around the cables to maintain the proper protection level (IP66/NEMA4x).

3.2. Terminal Connections

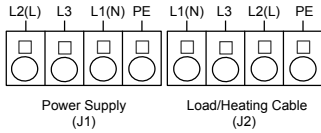

Connect the power supply and load wires to the terminals according to the type of net you have, e.g., three-wire or phase-to-neutral system.

BR1035A14

OJ Winterline®

3.2.1. Power Supply and Load

Power Supply

EU	US/CAN
3 phase 230/400 VAC ±10%, 50 Hz	3 phase 277/480 VAC ±10%, 60 Hz
1 phase 230 VAC ±10%, 50 Hz	Single phase 120 VAC & 208/240 VAC ±10%, 60 Hz

Load/heating cable

EU	US/CAN
3 x 6900W 3 phase @ 230/400 VAC, 3 x 30 A	3 x 3600 W using 3 x single phase @ 120 VAC, 3 x 30 Amp
6900 W at 1 phase 230 VAC, 30 A	<ul style="list-style-type: none"> • 1 x 6240 W using single phase two wires @ 208 VAC, 1 x 30 Amp • 1 x 7200 W using single phase two wires @ 240 VAC, 1 x 30 Amp • 1 x 8310 W using 3 phase @ 277 VAC, 1 x 30 Amp • 1 x 14400 W using 3 phase @ 480 VAC, 1 x 30 Amp

3 phase	1 phase
Line (L1)	Neutral (N) or Line (L1)
Line (L3)	
Line (L2)	Line (L2)
Ground (PE)	Ground (PE)

3 phase	Single phase
Load (L1)	Neutral (N) or Load (L1)
Load (L3)	
Load (L2)	Load (L2)
Ground (PE)	Ground (PE)

3.2.1.1. Wiring Single Phase + Neutral

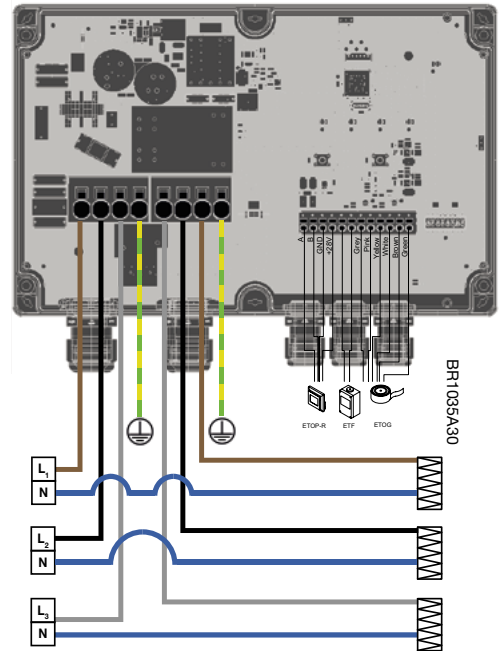
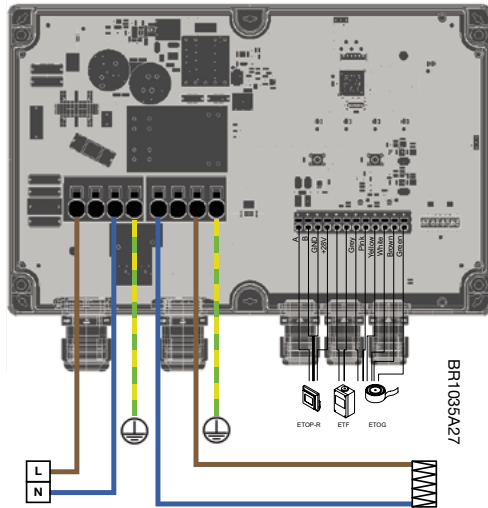

When supplied with three single-phase 120V wires, the neutral wires can be joined in the ETOP housing using a wire connector. A wire connector for neutral wires is not part of the interior of the ETOP.

3.2.1.4. Wiring 3-Phase + Neutral Star

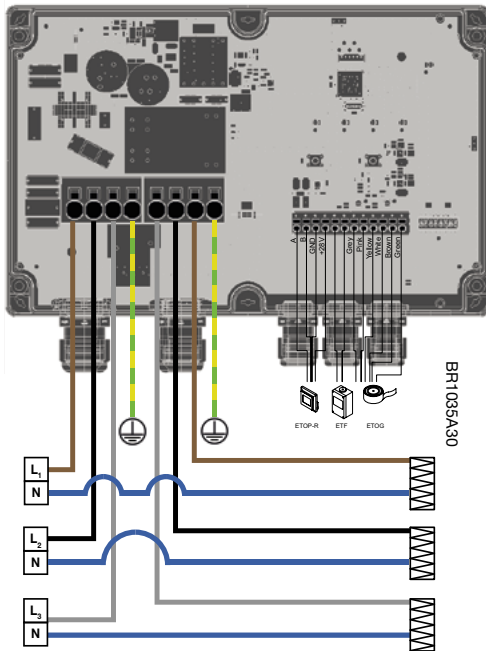

Neutral wires can be joined together in the ETOP housing using a wire connector. A connector for neutral wires is not part of the interior of the ETOP.

OJ Winterline®

3.2.2. Sensors and Remote Control

Connect the wires for the sensors and the remote control panel to the terminals according to the type of sensors required in the system.

Remote Control Panel, ETOP-R (Optional)

- Terminal 1: HMI - A
- Terminal 2: HMI - B
- Terminal 3: HMI - GND
- Terminal 4: HMI - Supply (+28 VDC / 35 mA)

Sensors:

- Terminal 5: Temp sensor 2 - GND
- Terminal 6: Temp sensor 2 - Signal
- Terminal 7: Temp sensor 1 - GND
- Terminal 8: Temp sensor 1 - Signal
- Terminal 9: Moisture sensor - Signal 1
- Terminal 10: Moisture sensor - Signal 2
- Terminal 11: Heating element in sensor ETOG/ETOR - GND
- Terminal 12: -Heating element in sensor ETOG/ETOR - supply (+28 VDC / 125 mA)

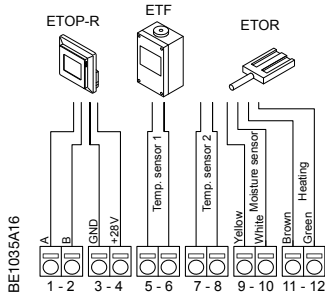
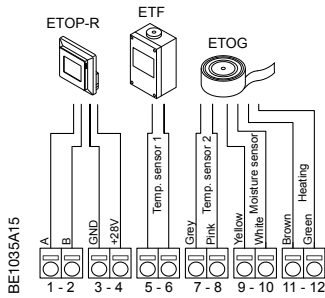

3.3. External Sensors and Remote Controller

The remote controller uses readings from temperature and moisture sensors, to ensure optimal economic power consumption while keeping outdoor areas and roofs free of ice and snow.

3.3.1. Ground Sensor - ETOG

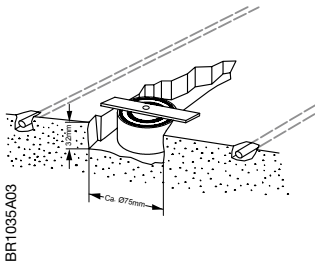
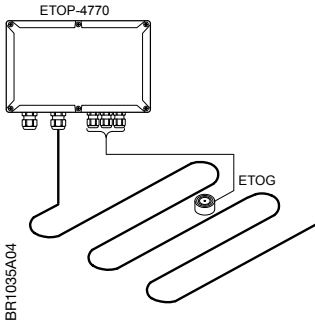

Designed for embedding in the surface of the outdoor area.
Measures temperature and moisture.

Should be installed where the worst snow and ice problems normally occur. The sensor should be embedded in a concrete base on a hard surface, with the top of the sensor flush with the surface.

Where an asphalt surface is used, or where easy installation is desired, installing ETOG-56 together with ETOK-1 is the obvious choice.

The sensor cable must be installed in accordance with current regulations.

NOTE: We strongly recommend the use of cable pipes in order to protect the sensor cable.

Detailed installation instructions are supplied with the sensor.

With ETOG-55, use the accompanying installation plate.

With ETOG-56, use the ETOK-1 mounting kit.

NOTE: Remove the installation plate from ETOG-55 before initial start-up.

OJ Winterline®

3.3.2. Gutter Sensor - ETOR

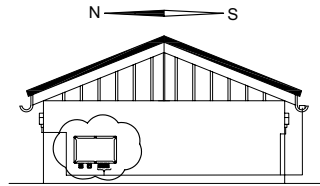

For installation in a gutter or downpipe on the sunny side of the building. It is important to ensure that the sensor contact elements face the flow of melt water.

Detailed installation instructions are supplied with the sensor.

Note that the pink and gray wires are not used.

BR1035A06

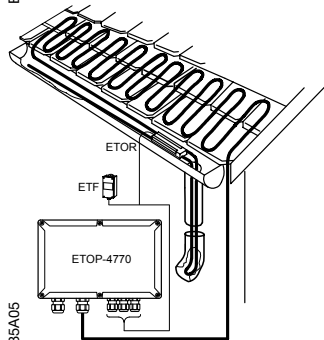

BR1035A05

OJ Winterline®

3.3.3. Outdoor Sensor - ETF-744/99

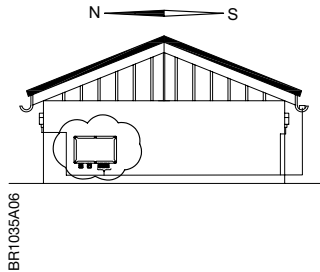

Measures temperature.

Is normally used in combination with ETOR gutter sensors.

An ETF sensor can also be used in combination with ETOG ground sensors for outdoor areas. The ETF sensor can detect rapid drops in air temperature, thus preventing icy areas.

The sensor should be mounted on the wall beneath the eaves on the north side of the building.

OJ Winterline®

3.3.4. Sensor Cable Recommendations

With the exception of ETOG-56, which has a 25 m (82 ft) cable, ETOG-55 and ETOR sensors are supplied with a 10 m (33 ft) cable, which can be extended up to approx. 200 m (650 ft) using standard installation cable:

6x1.5 mm² (6x AWG 15) for ETOG,
4x1.5 mm² (4x AWG 15) for ETOR and
2x1.5mm² (2x AWG 15) for ETF.

The ETF sensor can be extended up to approx. 50 m (164 ft) in length. Sensor cables must be installed in accordance with current regulations. They must never be installed in the same conduit as power cables, as electrical interference may distort the sensor signal.

3.4. Connecting the Remote Controller (optional)

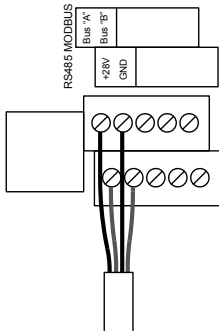

Connecting Modbus using screw terminals

For connection to ETOP-4770, please see 3.2. Terminal Connections

Note: Do not use the RJ12 6P4C terminal for Modbus

BR1035B02

4. Setup System

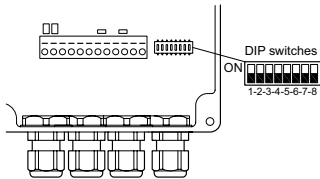

BR1035A10

4.1. Set after-run

To ensure that all ice and snow is completely melted, the heating system will stay on for a specified time after there is no longer any need to melt snow. If some ice and snow remains after the heating system has been deactivated, the after-run time should be increased slightly. The longer the afterheat duration, the more effective and less economical the system will be.

On DIP switch 1-4, you can set the after-run time. It can be set between 2 and 17 hours.

4.1. Set After-Run (continued)

DIP switches 1-4: After-run time, minimum 2 hours

All DIP switch settings here can be combined for the after-run duration, as required.

DIP	ON / OFF	DESCRIPTION
1-4	OFF	2 hours minimum after-run time
1 2-4	ON OFF	+1 hour to minimum after-run time
2 1, 3, 4	ON OFF	+2 hours to minimum after-run time
3 1, 2, 4	ON OFF	+4 hours to minimum after-run time
4 1-3	ON OFF	+8 hours to minimum after-run time
1-4	ON	17 hours maximum after-run time (2+1+2+4+8=17 hours)

4.2. Set Type of Application

Choose the sensor type used in the system.

DIP	ON / OFF	DESCRIPTION
5	OFF	ETOG Sensor
5	ON	ETOR Sensor*

*Sensor not heated from ETOP when load on output is activated.

DIP switch 6: NOT USED.

4.3. Set Moisture Sensitivity

Choose the required sensitivity as a combination of DIP switch 7 and 8.

DIP 7	DIP 8	SENSITIVITY
OFF	OFF	Minimum ¹⁾
ON	OFF	Low
OFF	ON	Normal
ON	ON	Maximum ²⁾

1) Ice and snow contains a lot of impurities, i.e., water has high conductivity.

2) Snow and water is very pure, i.e., water has very low conductivity.



4.4. Recommended Settings



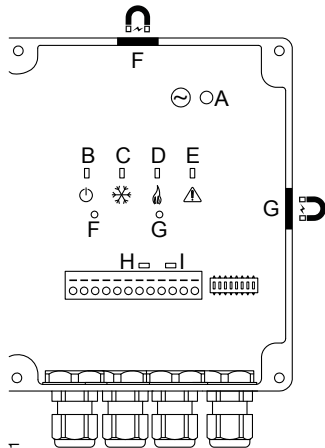

DIP	ON / OFF SETTING	DESCRIPTION
1	OFF	After-run time: 2 OFF 2 hours
2	OFF	
3	OFF	
4	OFF	
5	OFF	Moisture sensor type: ETOG sensor
6	Not used	
7	OFF	Moisture sensor sensitivity: Normal
8	ON	

5. Control



Push buttons and magnetic sensors have equivalent functions.

PUSH BUTTON	MAGNETIC SENSOR	LED
	Top	Flashes in 2 sec
	Right side	Flashes in 2 sec















SYMBOLS USED	
	LED on
	Flashing LED
	LED off
	Push button

OJ Winterline®

6. Daily Use

6.1. General Operation

The controller has two push buttons (or magnetic sensors) for easy operation and LED lights indicate the state of the system.

No.	ICON	FUNCTION	LED	DESCRIPTION
A		POWER ON	 Green	Power supply connected No supply voltage
B		SYSTEM ON	 Green	System active: Automatic detection and control working Standby: System will only heat if Forced Heat is activated.
C		LOW TEMP	 Green	Load will heat if moisture is detected. Too warm for automatic load activation (5 °C)
D		HEATING	 Green  RED	Melting active No load on heating Forced Heat active
E		ERROR	 RED	Error detected Test mode active
F		SYSTEM ON		Push button to start automatic control. Temperature and snow & ice detection sensors are active. Hold button for 3 sec. to stop system
G		Forced Heat		Push button to start Forced Heat Hold button for 3 sec. to stop Forced Heat

6.2. System On

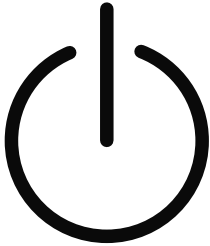

Press the button to start the snow-melting system.

A green LED indicates that the system is active.

Press and hold the button for 3 sec. to stop the snow-melting system

6.3. Low temperature

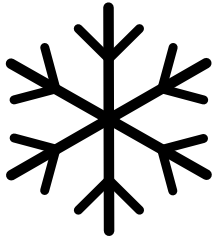

A green LED indicates that the temperature is within the specified range.

Depending on the presence of ice or snow detected by the moisture sensor, snow-melting is running.

6.4. Heating

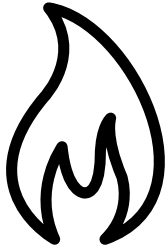

A Green LED indicates that the snow-melting is active and the heating is on.

6.5. Forced Heat



In order to force ice and snow melting ON in any condition, it is possible to turn on the output relay to start the heating.

Press the button to start the Forced Heat setting.

A flashing green light indicates: Forced Heat is active. The heating will stay on until manually stopped.

Press and hold the button for 3 sec. to stop Forced Heating. The system will return to a normal state.

Make sure to turn off the Forced Heat setting when all the snow and ice has melted, to save energy.

6.6. Error



A red light indicates that the system detects an error .

A red flashing LED indicates that the Test Mode function is activated.

6.7. Maintenance

To ensure that the system functions properly, it is necessary to keep the controller, sensors and remote in good condition.

Every autumn or when the need arises, the system must be inspected.

Undertake a visual inspection of the following:

ETOP-4770

- Cracks in the casing
- Defective gaskets
- Water/moisture inside the lid (condensation)
- Power LED on

ETOP-R

- Clean with a dry towel
- Power on LED on

ETF-744, ETOR and ETOG

- Visual inspection









7. Test System

At any time, the system can be tested by entering test mode.

7.1. Test Mode LED Overview

See the position of the LED in section 5. Control.

7.1. Test Mode LED Overview (continued)

No.	ICON	FUNCTION	LED / BUTTON	DESCRIPTION
A		POWER ON	● Green	Power connected
B		SYSTEM on / off	● Green	System active
C		Internal temp Sensor	● Green ● Green ○	Internal temp sensor within specified range Internal temp sensor outside specified range Internal temp sensor error or disconnected
D		External temp sensor 1	● Green ● Green ○	External temp sensor 1 within specified range External temp sensor 1 outside specified range External temp sensor 1 error or disconnected
E		ERROR	● RED	Test mode active
F		Test mode on / off		Test mode on / off Start: Push / swipe Stop: Hold for 3 sec.
G		Test mode on / toggle		Test mode on / toggle Start: Push / swipe Toggle: Swipe
H		External temp sensor 2	● Green ● Green ○	External temp sensor 2 within specified range External temp sensor 2 outside specified range External temp sensor 2 error or disconnected
I		MOIST	● Green ● Green ○	Sensor detects moisture Sensor does not detect moisture Moisture sensor error or disconnected

7.2. Test Mode

	BUTTONS	MAGNETIC SENSOR
1. Start test mode by	pressing the buttons in the following sequence: ⏻ 🔍 ⏻ 🔍	swiping the magnetic sensors in the following sequence: "top" - "right-side" - "top" - "right-side".
2. Toggle through test mode status by	pressing the 🔍 button	swiping magnet on right side magnetic sensor.
3. Exit test mode at any time by	pressing ⏻ button for 3 sec.	holding magnet on top magnetic sensor for 3 sec.

7.2. Test Mode (continued)

	A	B	C	D	E	H	I	HEATING ELEMENT POWERED	
Symbols								Moisture sensor heated	Relay
Idle State									
Detecting State								×	
Melting State								×*	×
After-run State									×
Forced Heat State									×
Moisture testing							moisture not detected moisture detected sensor disconnected	×	
T1, Internal temp sensor			within range outside range						
T2, External temp sensor 1 (ETOG/ETOR)				within range outside range					
T3, External temp sensor 2 (ETF)						within range outside range			

* If the measured temperature is under 5 °C/41 °F, Sensor Heating will be activated

Step 1-6: Test of output on sensor and load

Step 7-9: Test of temp sensor connection and legal range

OJ Winterline®

8. Technical Specifications

8.1. Dimensional drawing

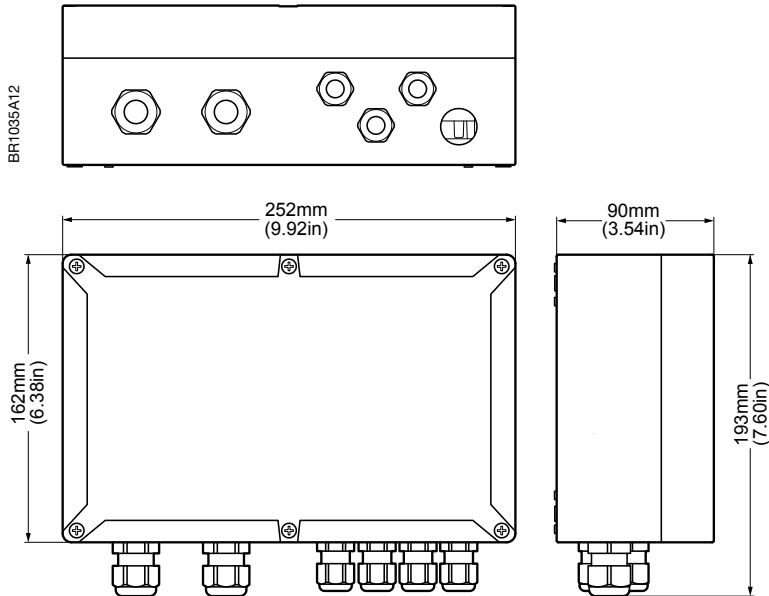

Values are based on SI units. All non-SI units are calculated.

OJ Winterline®

8.2. Controller - ETOP-4770

Max. load/supply	EU: 3x6900W at 3- 230/400 VAC, 3x30A 6900W at ~ 230 VAC, 30A US/CAN: 3x8310W at 3- 277/480 VAC, 3x30A 3x3600W at 3- 120/208 VAC, 3x30A 3600W at ~ 120 VAC, 30A 7200W at ~ 240 VAC, 30A
Standby consumption	Approx. 1.25W @ 230VAC
Ambient air humidity	10-95% noncondensing
Ambient operating temp.	-50/+50°C (-58 °F/ 122 °F)
Control temperature range	-30/+30°C (-22 °F/ 86 °F)
Storage/transport temp.	-50/+70°C (-58 °F/ 158 °F)
Dimensions	H/162, W/252, D/90 mm H/6.38, W/9.92, D/3.40 in
Weight	1500 g
Control pollution degree	2
Overvoltage category	III
Type of action	1.B
Software class	A
Rated impulse voltage	4kV
Ball pressure temperature (TB)	125°C
Classification	Class I

OJ Winterline®

8.2. Controller - ETOP-4770 (continued)

Dimensions	H/162, W/250, D/89 mm H/6.38, W/9.84, D/3.50 in
Build-in depth	23 mm
DIN module size	3xM36
Weight	1500 g
Display	H/25, W/38 mm segment backlit
Control pollution degree	2
Overvoltage category	III
Type of action	1.B
Software class	A
Rated impulse voltage	4kV
Ball pressure temperature (TB)	125°C

8.3. Ground Sensor - ETOG

Purpose of control	Moisture detection and measurement of ground temperature
Method of mounting	Embedded in outdoor surfaces
Sensor type	NTC (12 kilohms)
Max. cable length	200 m
Enclosure rating	IP 68
NEMA Class	6P
Ambient operating temp.	-57/+158°F / -50/+70°C
Dimensions, ETOG-5x	H/32, Ø60 mm 1.26 / 2.36 in
Dimensions, ETOK-56	H/78, Ø63.5 mm 3.07 / 2.50 in

Note: Please follow the “Sensor Cable Recommendations” in Section 3.3.4.

8.4. Gutter Sensor - ETOR

Purpose of control	Moisture detection
Method of mounting	In gutter or downpipe
Sensor type	NTC (12 kilohms)
Max. cable length	200 m
Enclosure rating	IP 68
NEMA Class	6P
Ambient operating temp.	-57/+158°F / -50/+70°C
Dimensions	H/105, W/30, D/13 mm 4.13 / 1.18 / 0.51 in

Note: Please follow the “Sensor Cable Recommendations” in Section 3.3.4.

8.5. Outdoor Sensor - ETF-744/99

Purpose of control	Measurement of outdoor temperature
Method of mounting	On the wall
Sensor type	NTC (12 kilohms)
Max. cable length	200 m
Enclosure rating	IP 54
NEMA Class	3
Ambient operating temp.	-57/+158°F / -50/+70°C
Dimensions	H/86, W/45, D/35 mm 3.39 / 1.77 / 1.38 in

Note: Please follow the “Sensor Cable Recommendations” in Section 3.3.4.

8.6. Remote Control Panel - ETOP-R

Purpose of control	Remote control of ETOP
Method of mounting	Wall mounting indoor
Max. cable length	30 m
Enclosure rating	IP 20
NEMA Class	?
Ambient operating temp.	5/+50°C (41 °F/122 °F)
Control temperature range	-57/+158°F / -50/+70°C
Storage/transport temp.	-50/+70°C (-58 °F/ 158 °F)
Dimensions	H/32, Ø60 mm 1.26 / 2.36 in

Note: Please follow the “Sensor Cable Recommendations” in Section 3.3.4.

9. Contact Information

Contact your supplier for further information

OJ Winterline®