



ADOUR

BLADE HOLDERS FOR SCORING UNDER THE CRUST

In food and detectable composite material.

Specially designed, its shape facilitates scoring under the crust of all breads and baguettes.

- SAFETY**
- Side protection.
 - Protective cap.

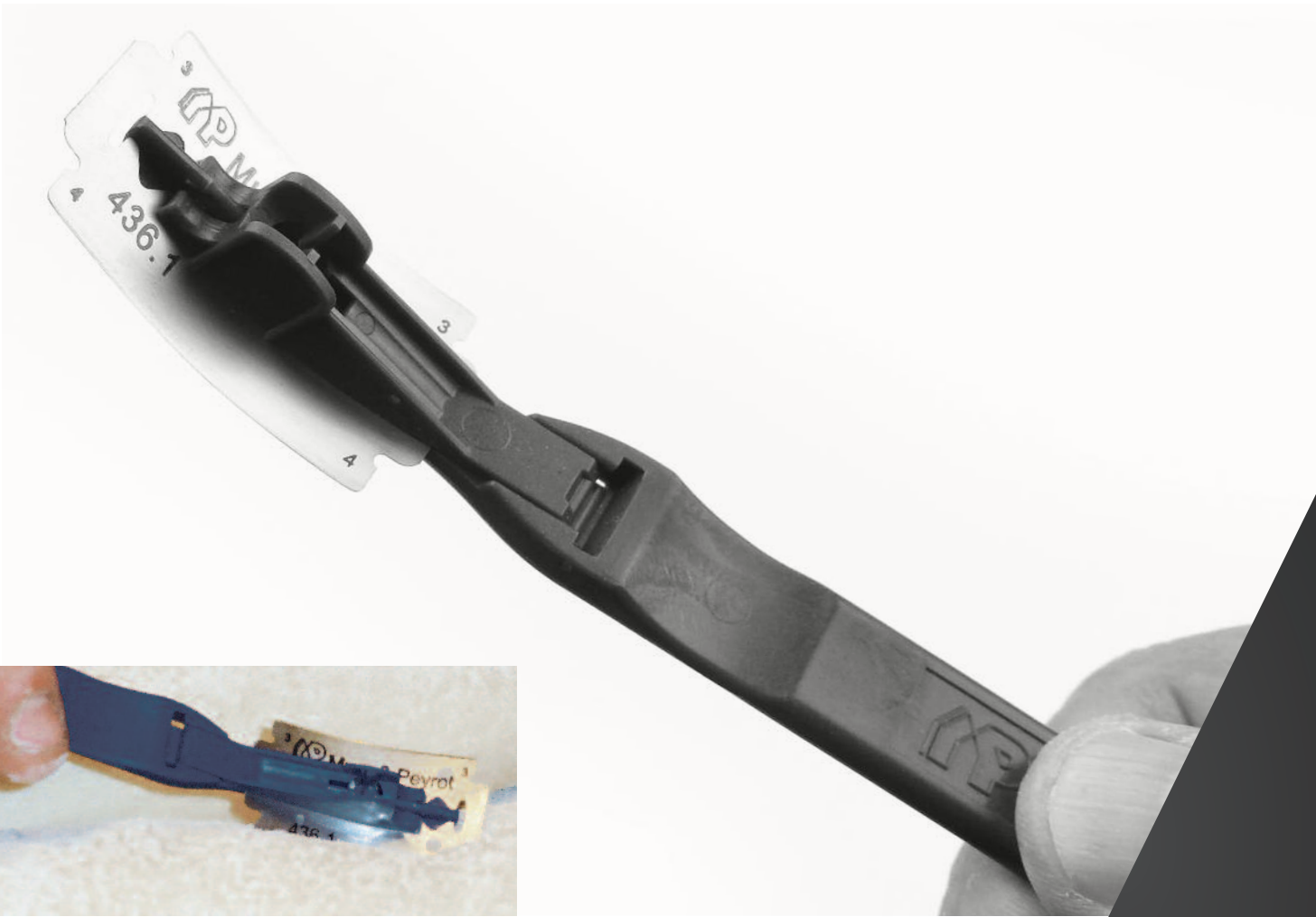

FOR RIGHT AND LEFT
HANDED USERS



LIGHT



ERGONOMIC



AVOIDS
MSDs



ENHANCED SECURITY



RESISTANT TO
DETERGENTS

TECHNICAL SHEET

SPECIALLY DESIGNED FOR SCORING UNDER THE CRUST

VERY GOOD HANDLING, GESTUAL COMFORT.

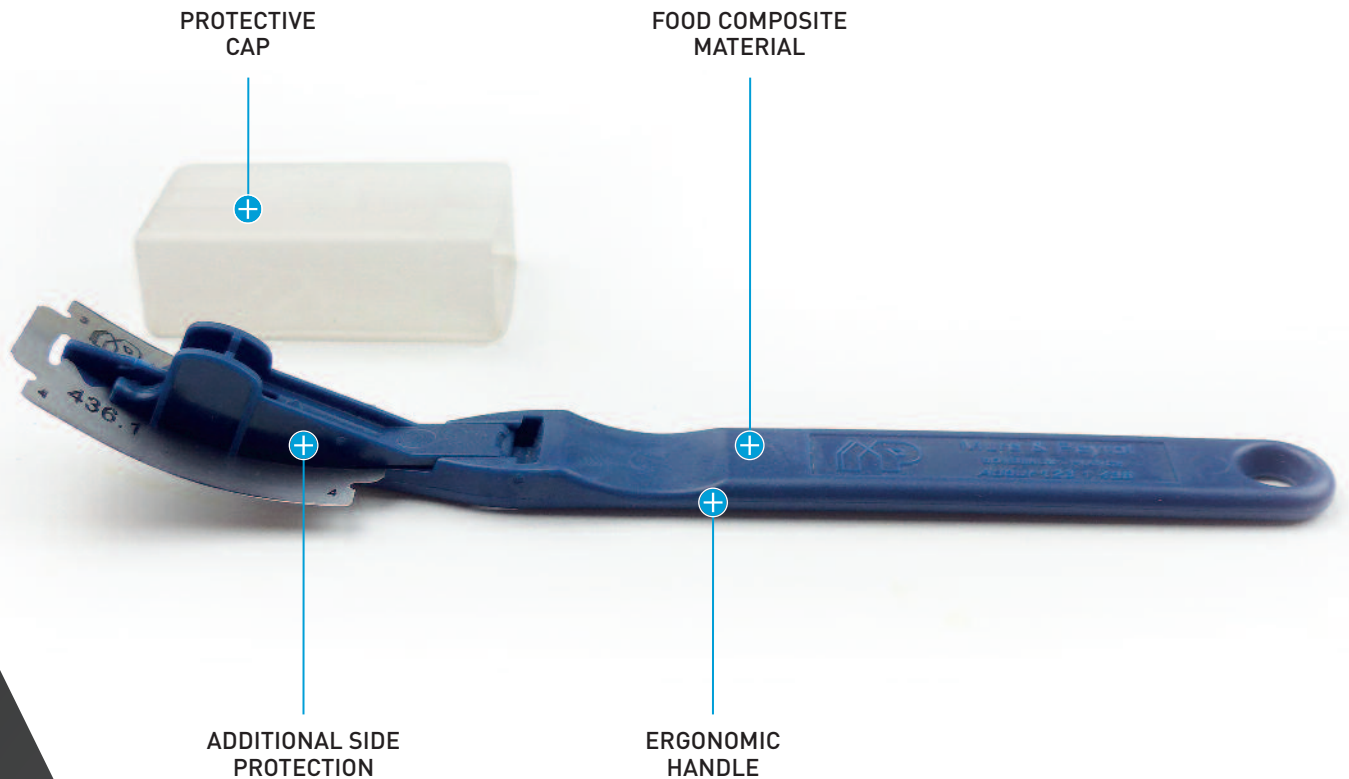

ASSETS



DELIVERED WITH A FOOD STAINLESS STEEL BLADE REF 436.1 ALD



ERGONOMIC AND LIGHT FOR RIGHT & LEFT HANDED



IN FOOD COMPOSITE MATERIAL

FUNCTIONS



For scoring under the bread crust



For scoring under the crust of baguettes



OTHER CHARACTERISTICS

- Very light (12 g).
- When the blade is worn, it is rotated or changed.
- The blade is numbered at the 4 corners.
- Great ease of work.
- Resistant to acetone and detergents.
- Ideal for all bakers, clerks and apprentices.

BLADE CHANGE

01/ Pinch the blade holding branch on both sides.

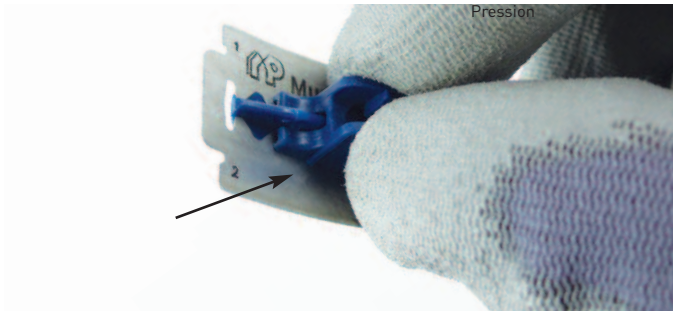

02/ Lift the branch to release the blade.



03/ Gently remove the blade from the front. Place a new blade by positioning it on the lugs. Lower the hood and lock it by clipping it.

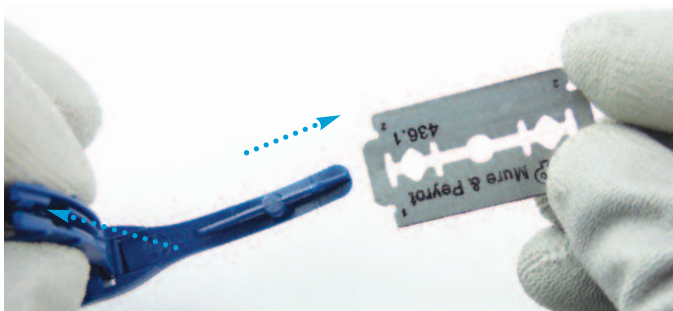

BLADES

DELIVERED WITH

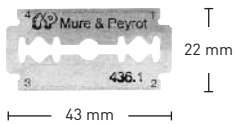

REF 436.1 ALD Thk 0,1 mm
Food stainless steel blade +13 % Cr.

OTHER COMPATIBLE BLADES

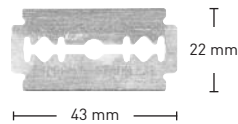

REF 536.1 ALD Thk 0,1 mm
Food stainless steel blade +13 % Cr.

Blade Reference	Description	Type	Dimensions (in mm) Length • Width • Thickness	Sharpening Angle	Hardness
436.1 ALD	Razor-type blade numbered in all 4 corners	Food stainless steel blade +13 % Cr.	43 x 22 x 0,1	20°	57 Hrc
536.1 ALD	Razor-type blade	Food stainless steel blade +13 % Cr.	43 x 22 x 0,1	12°	58 Hrc

TECHNICAL SHEET (in mm)

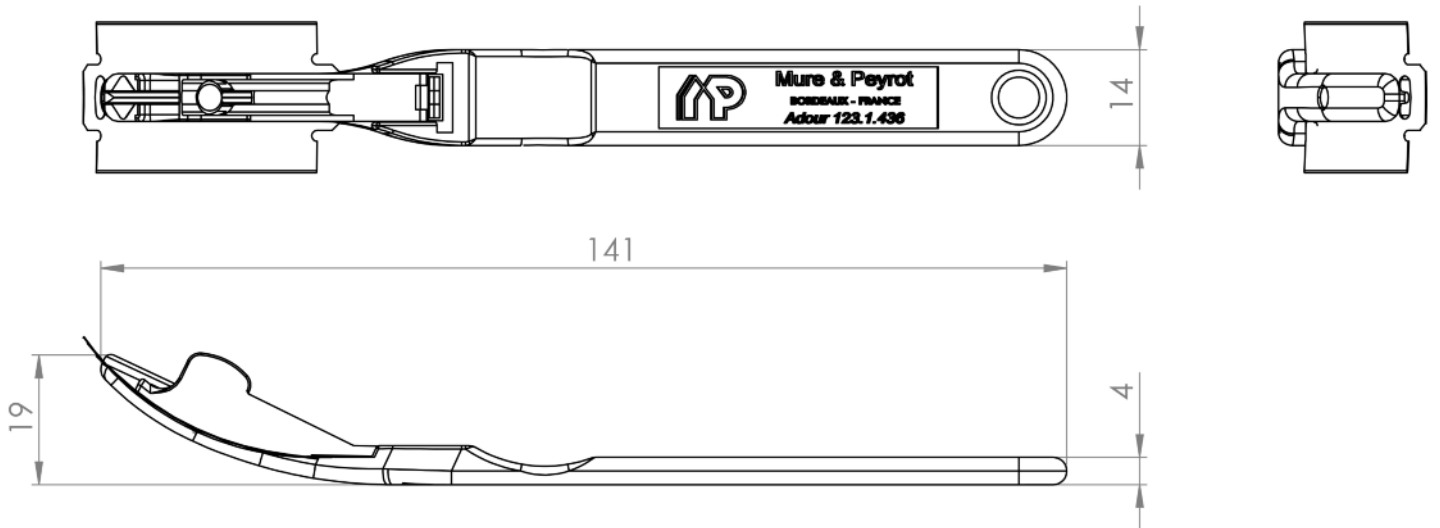

Packaging	Weight PKG	Dimensions (in mm) Length • Width • THK	Quantity PKG	Units	Accessories	Material	Color
IN BOX	12 g	141 x 19 x 14	10	4 units	Handle	Food-grade and detectable polyoxymethylene	Dark blue
					Latch	Food-grade and detectable polyoxymethylene	Dark blue
					Protective cap	Food grade polypropylene (PP)	Translucent white
					Blade 436.1 ALD	Food stainless steel blade +13 % Cr	Metal grey

Food approval awarded by LNE.

MP
MURE & PEYROT

MURE & PEYROT
25, rue Roger Touton • BP 50120
Parc d'Activités Bordeaux Nord
33041 BORDEAUX CEDEX - FRANCE

Tel.: +33 (0)556 693 200 / Fax: +33 (0)556 693 202 / E-mail: mail@mure-peyrot.com

FOR MORE INFORMATION
MURE-PEYROT.COM