

## BONNIE e CLYDE

SUSPENSION

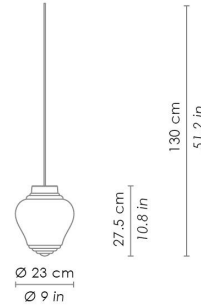

Mouth-blown glass handcrafted on standstill mold with "rigadin" relief finish in two different shapes and various colours. Matt grey or white painted metal parts. Grey fabric cables. Canopies are not included. Select a canopy from the following pages to create a single or multi light pendant.

CODE	COLOR	
ZA-LCL0101	Clear	
ZA-LCL0104	Amber	
ZA-LCL0105	Amethyst	
ZA-LCL0109	Grey	
ZA-LCL0120	Light blue	
ZA-LCL0121	Silver	
ZA-LCL0122	Antique gold	
ZA-LCL0123	Bronze	
ZA-LCL0124	Pink gold	

### DIMENSIONS AND HOLES

Dimensions  $\varnothing$  23 - h max 130 cm /  $\varnothing$  9 - h max 51,2 in

### ILLUMINOTECHNICAL SPECIFICATIONS

Source E26  
Total Watt 75 W

### ELECTRICAL SPECIFICATIONS

Voltage 120V  
Frequency 50 - 60 HZ

## PENDANT SYSTEM CANOPIES

### SUSPENSION

Use a Pendant System Canopy along with a Zafferano Lighting pendant to create single or multi-light pendants. Compatible with Sixties, Balloon, Bonnie & Clyde, Romeo & Giulietta, Perle, and Seventies pendants.

#### Rosone singolo / Single canopy

5,8  
2,3"  **ZA-LGR0001** grigio / grey  
**ZA-LGR0002** bianco / white

8,3  
3,3" 

\* 7  
2,7"  **ZA-LGR0011** grigio / grey  
**ZA-LGR0012** bianco / white  
1,8  
0,7"   
10  
3,9"   
Incasso su cartongesso /  
Recessed canopy on plasterboard  
\*foro installazione / installation hole

6,3  
2,5"  **ZA-LGR0120** bianco / white  
**ZA-LGR0121** corten  
**ZA-LGR0122** grigio scuro / dark grey  
**ZA-LRB0001** ottone brunito spazzolato  
brushed burnished brass  
12  
4,7" 

#### Rosone tondo per sospensioni multiple / Round canopy for hanging multiple lamps

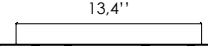
34  
13,4"   
4,6  
1,8"

**Rosone per sospensione 3 luci**  
**Canopy for hanging lamp 3 lights**

**ZA-LGR0063** grigio / grey  
**ZA-LGR0073** bianco / white

Luci disposte sullo stesso livello  
Lights on the same level:  
Ø max 25 cm - 9,8 in

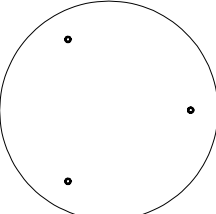
40  
15,7" 

Disponibile su richiesta con finitura calamina / Available on request with calamine finish

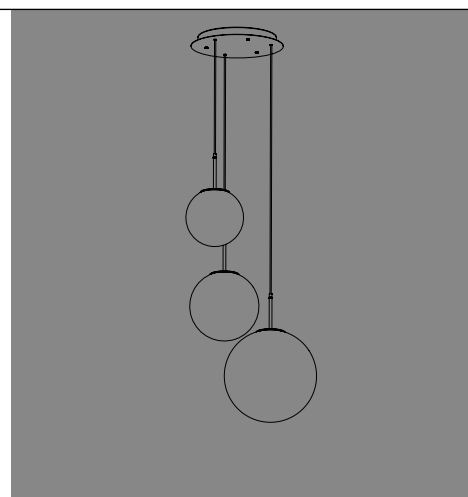

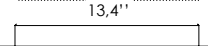
34  
13,4"   
4,6  
1,8"

**Rosone per sospensione 5 luci**  
**Canopy for hanging lamp 5 lights**

**ZA-LGR0065** grigio / grey  
**ZA-LGR0075** bianco / white

Luci disposte sullo stesso livello  
Lights on the same level:  
Ø max 17 cm - 6,7 in

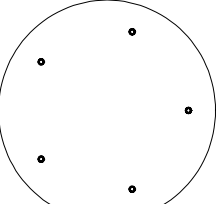
40  
15,7" 

Disponibile su richiesta con finitura calamina / Available on request with calamine finish

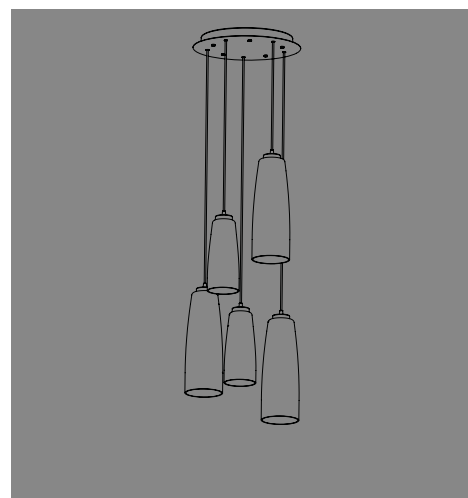

## Rosone per sospensioni multiple (supporti di decentramento inclusi) Canopy for hanging multiple lamps (decentralisation supports included)

Esempio d'installazione / Example of installation

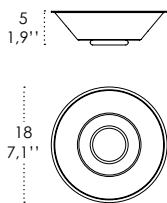

**ZA-LGR0004** grigio / grey  
**ZA-LGR0014** bianco / white  
**ZA-LRB0002** ottone brunito  
spazzolato/brushed burnished brass  
**2 luci + 2 supporti**  
**2 lights + 2 supports**

**ZA-LGR0005** grigio / grey  
**ZA-LGR0015** bianco / white  
**ZA-LRB0005** ottone brunito  
spazzolato/brushed burnished brass  
**5 luci + 5 supporti**  
**5 lights + 5 supports**

**ZA-LGR0003** grigio / grey  
**ZA-LGR0013** bianco / white  
**ZA-LRB0003** ottone brunito  
spazzolato/brushed burnished brass  
**3 luci + 3 supporti**  
**3 lights + 3 supports**

**ZA-LGR0008** grigio / grey  
**ZA-LGR0018** bianco / white  
**ZA-LRB0008** ottone brunito  
spazzolato/brushed burnished brass  
**8 luci + 8 supporti**  
**8 lights + 8 supports**



(n)

Supporti per decentramento cavi inclusi.  
Supports for cable decentralisation included.

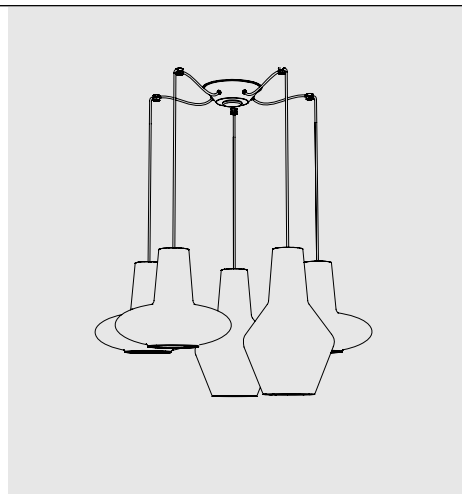

## Rosone per sospensioni multiple (supporti di decentramento esclusi) Canopy for hanging multiple lamps (decentralisation supports not included)

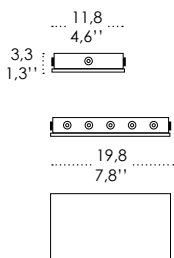

**Rosone per sospensione 1-12 luci**  
**Canopy for hanging lamp 1-12 lights**

**ZA-LGR0411** grigio / grey  
**ZA-LGR0401** bianco / white

**Supporto singolo per decentramento cavo.**  
**Single support for cable decentralisation.**

**ZA-LGR0100** grigio / grey  
**ZA-LGR0200** bianco / white  
**ZA-LGR0300** ottone brunito spazzolato  
brushed burnished brass

