







# TWISTED MINDS

ALL RULES BROKEN

## TM-X5

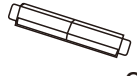
【operating manual】

**A Package details**

 x17	 x 6	 x 2
 x 3	 x 8	 x 5

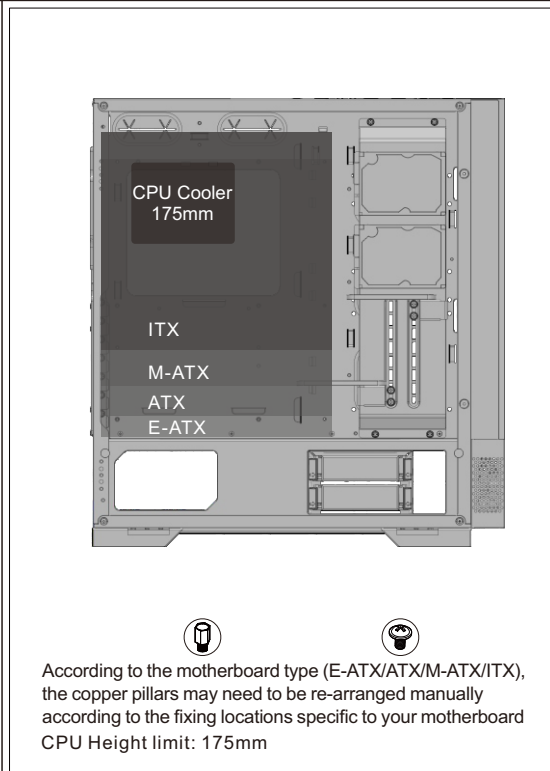
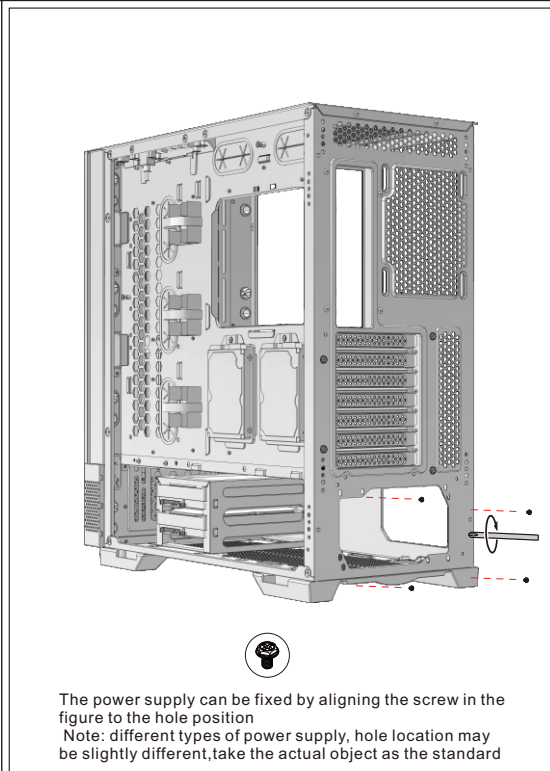
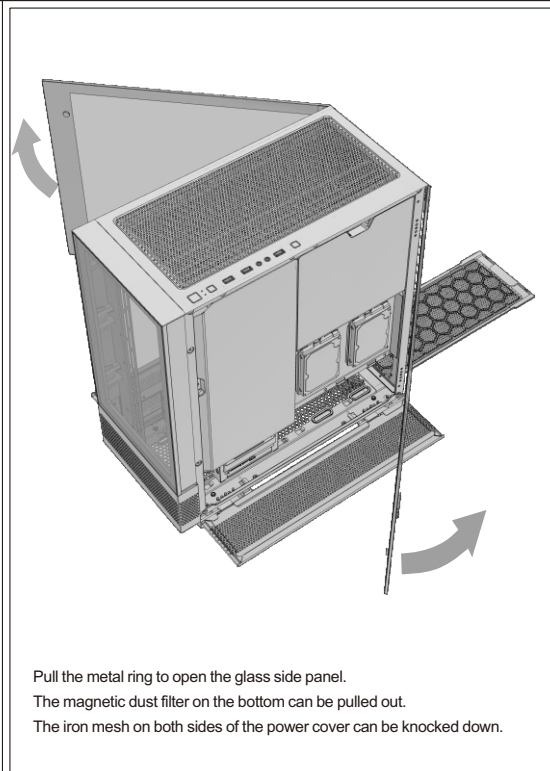
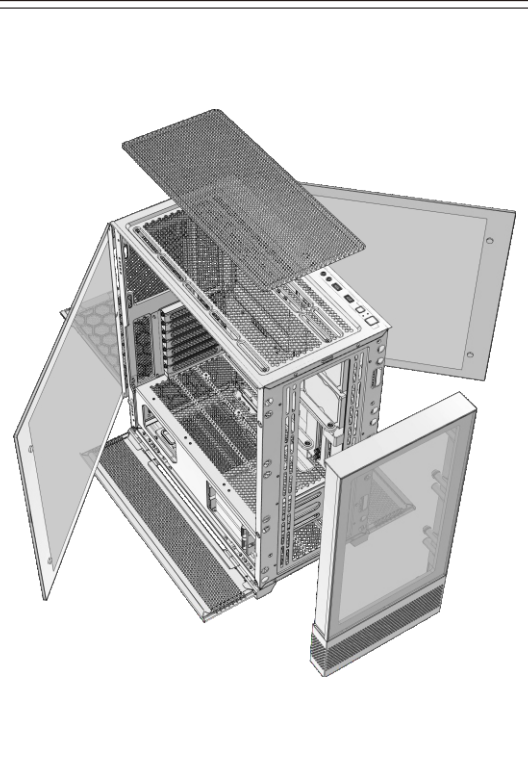
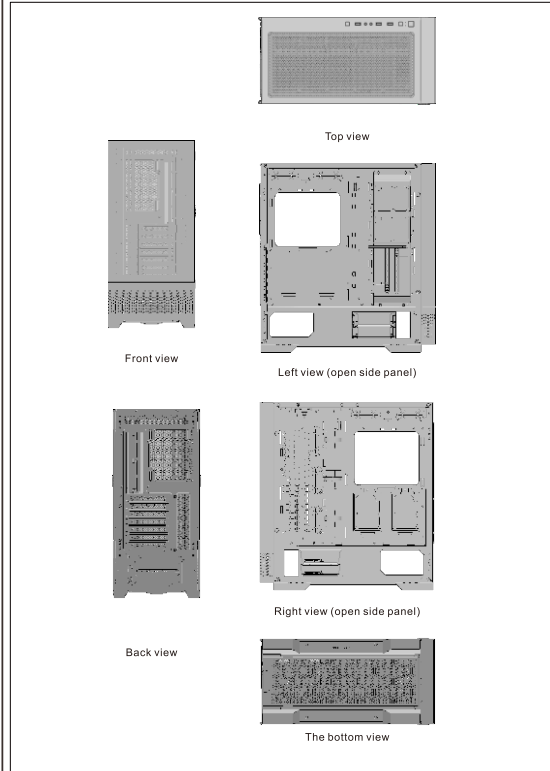
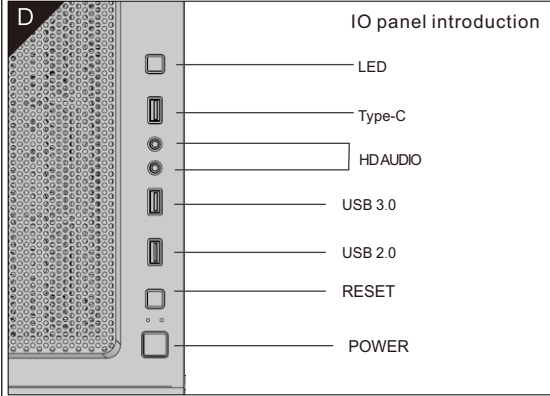
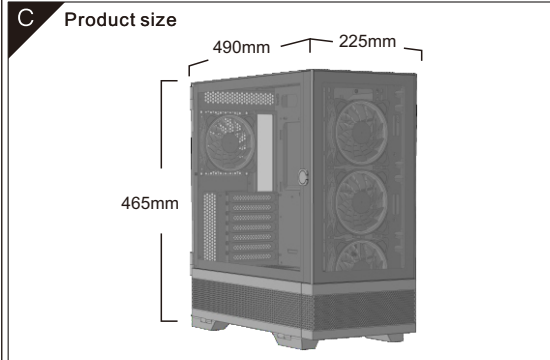
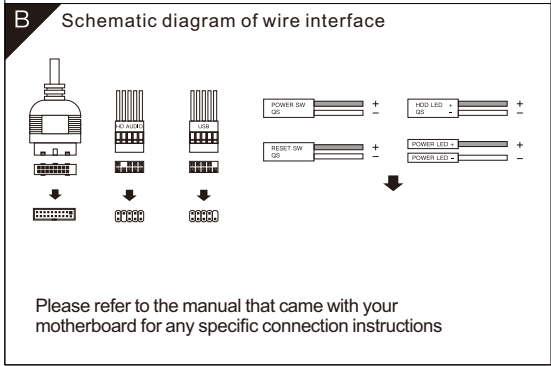

**J** The graphics card installation

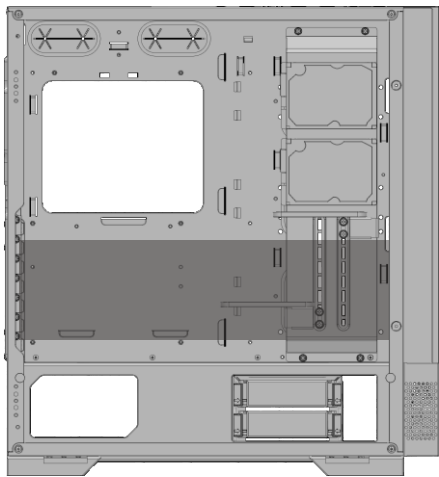

**VGA Length:** No fan can be installed 400mm, installed fan 370mm

**K** Panel disassembly

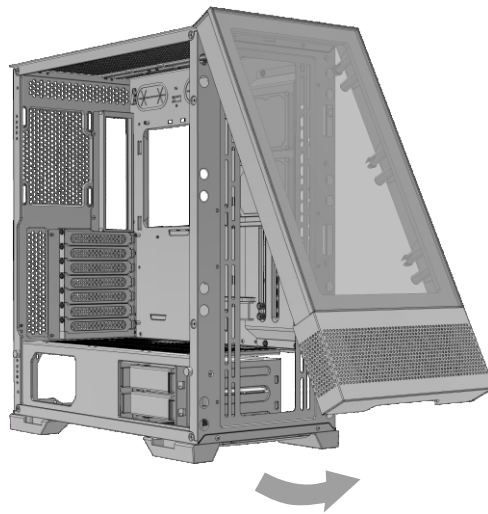

Remove the glass front panel: Remove side screws, slide the glass side panel to the right.

**L** Fan installation

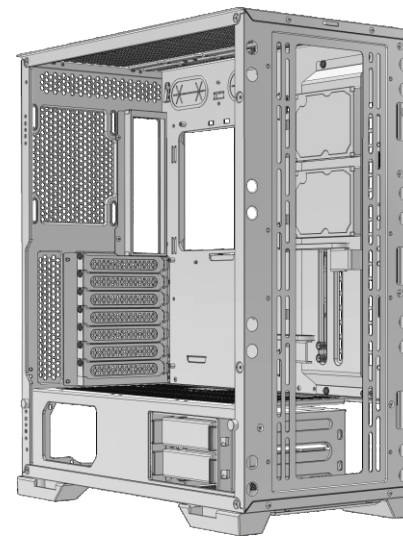

**Fan Support:** Top: 120/140 mm x 3  
Rear: 120mm x 1  
Front: 120mm x 3  
PSU cover: 120mm x 3  
MB Tray: 120mm x 2

**M** Water cooling installation

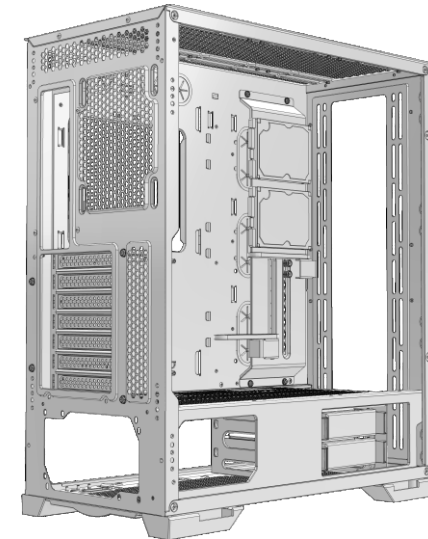

**Water cooling:** 360mm at Top  
360/420mm at Front

**N** SSD installation

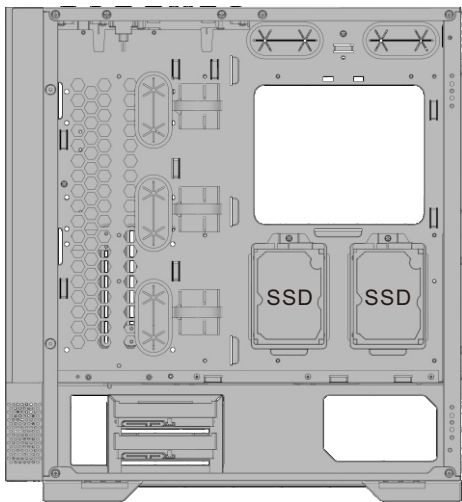

SSD\*4

Secure the SSD with screws

**O** HDD installation

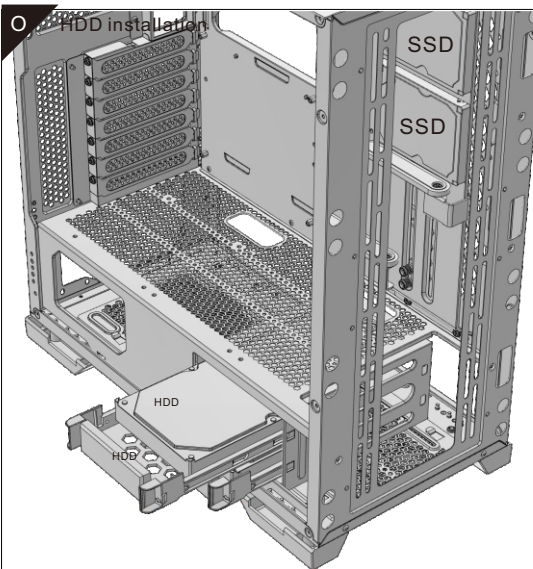

HDD\*2

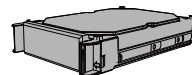

Pull out the HDD cage  
Put your HDD in the cage

**TWISTED MINDS**  
ALL RULES BROKEN