

TM32RFA Monitor Instruction Manual



Please read this manual thoroughly before use, and keep it handy for future reference

EMAIL: INFO@TWISTEDMINDS.CO

WEBSITE: WWW.TWISTEDMINDS.CO

SAFETY INFORMATION



- Read these instructions - All the safety and operating instructions should be read before this product is operated.
- Keep these instructions - The safety and operating instructions should be retained for future reference.
- Heed all warnings - All warnings on the appliance and in the operating instructions should be adhered to.
- Follow all instructions - All operating and usage instructions should be followed.
- Do not use this equipment near water, or in humid environments – The appliance should not be used near water or moisture e.g. in a wet basement or near a swimming pool.
- Clean only with a dry cloth. Do not use solvents or petroleum based fluids.
- Do not block any ventilation openings.
- Do not install near any heat sources such as radiators, stoves or other apparatus (including amplifiers) that produce heat.
- Do not tamper with the supplied plug. This plug is a BS1363 standard plug.
- Protect the power cord from being walked on or trapped, particularly at the plug and at the point where it exits from the appliance.
- Only use attachments/accessories specified by the manufacturer.
- Use only with a cart, stand, tripod, bracket or table specified by the manufacturer or sold with the apparatus. When a cart or stand is used, use caution when moving it to avoid any injuries or damage from it tipping over.
- Unplug the apparatus during lightning storms or when unused for long periods of time.
- Refer all servicing to qualified personnel. Servicing is required when the apparatus has been damaged in any way, such as if the power supply cord or plug is damaged, liquid has been spilled or objects have fallen into the apparatus or it has been exposed to rain or moisture, it does not operate normally or has been dropped.
- Please keep the unit in a well-ventilated environment.
- The monitor should only be connected to a mains power supply as rated on the back of the equipment.
- To prevent overload, do not share the same power supply socket with too many other electronic components.
- Do not place any connecting wires where they may be stepped on or tripped over.
- Do not place heavy items on the cable as this may cause damage.
- When removing from a socket hold by the plug and not the wires.
- Disconnect the power immediately and seek professional help if the plug or cable is damaged, liquid has spilt onto the set, if accidentally exposed to water or moisture, if anything accidentally penetrates the ventilation slots or if the set does not work normally.
- Do not remove the safety covers. There are no user serviceable parts inside.

Trying to service the unit yourself is dangerous and may invalidate the product's warranty. Only qualified personnel should service this apparatus.

- Do not block ventilation slots on the back cover. The monitor can be placed in a cabinet but ensure at least 5cm (2") clearance all around. Do not tap or shake the screen, this may damage internal components.
- **WARNING:** To reduce the risk of fire or electric shock, do not expose this apparatus to rain or moisture. The apparatus shall not be exposed to dripping or splashing and objects filled with liquids, such as vases, shall not be placed on the apparatus.
- **WARNING:** The wall plug socket is used as a disconnection device and should remain readily accessible.
- **WARNING:** The batteries shall not be exposed to excessive heat such as direct sunlight or fire.



AT FULL VOLUME, PROLONGED LISTENING MAY DAMAGE THE USER'S HEARING.

 <p>This warning sign is to warn of dangerous voltage inside the product.</p>	 <p>CAUTION: To reduce the risk of electric shock, DO NOT remove the cover (or back). No user serviceable parts inside. Refer servicing to qualified service personnel.</p>	 <p>This warning sign is to alert you of important instructions accompanying the product.</p>
---	--	---

WHAT'S INCLUDED



User manual

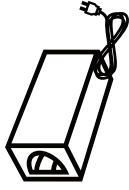

Power supply



Power cable



HDMI

CONNECTIONS AVAILABLE ON THE MONITOR

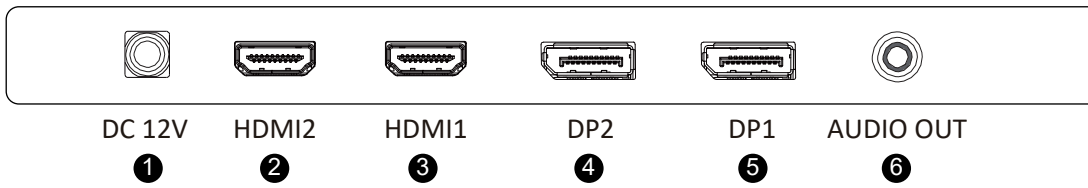

- ① POWER (DC 12V, 5A)
- ② HDMI2 (Support FHD 240Hz, HDR, MPRT, FreeSync)
- ③ HDMI1 (Support FHD 240Hz, HDR, MPRT, FreeSync)
- ④ DP2 (Support FHD 240Hz, HDR, MPRT, G-Sync)
- ⑤ DP1 (Support FHD 240Hz, HDR, MPRT, G-Sync)
- ⑥ AUDIO OUT

WALL MOUNTING

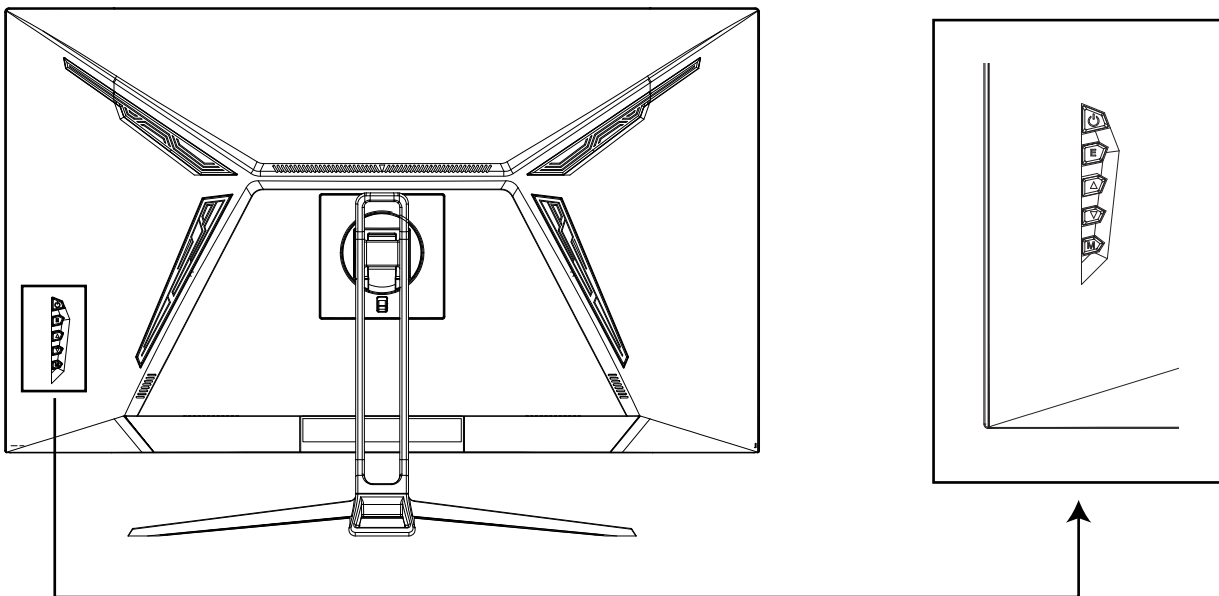

①		Turn the monitor on or Off
②	E	Select signal source or Exit OSD
③		Go Up on the Main OSD Menu Increase the value of a selected item
④		Go Down on the Main OSD Menu Decrease the value of a selected item
⑤	M	Open the Main OSD Menu and Select submenu

Shortcut Key Guide

- 1 Activate the Signal Input Selection menu. Use ◀ and ▶ to navigate and M to select the source.
- 2 Activate the Line of Sight feature. Further press to cycle between the colors or turn off.
- 3 Activate the ECO Mode feature. Further press to cycle through the presets.



INITIAL SETUP

Connect the monitor to a power outlet.

1. Press the POWER button on the monitor or to turn it on (The indicator will be blue)
2. Connect the relevant cable to the corresponding input on the monitor. The source will be automatically detected.
3. To change between inputs, press the “Source” button on to enter the source menu. Use the “◀” and “▶” buttons to choose the input source between Auto Select, DP1, DP2, HDMI1 and HDMI2.

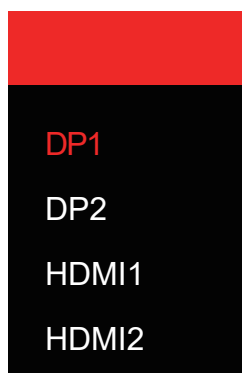

MENU OPTIONS

The menu for the monitor can be accessed by pressing the menu button on the control panel.

This menu is separated into the following sub menus: Picture Settings, Image Settings, Colour Temperature, OSD Settings, Reset, and Miscellaneous options, details of each menu can be found in the following section

OSD MENU

A . Input Source

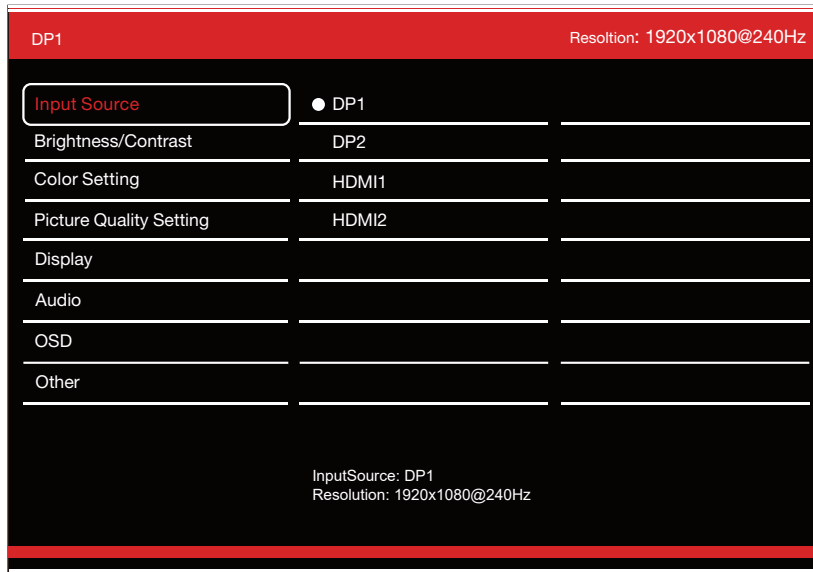

Switch the signal input to DP1, DP2, HDMI1, HDMI2.

B . Brightness/Contrast

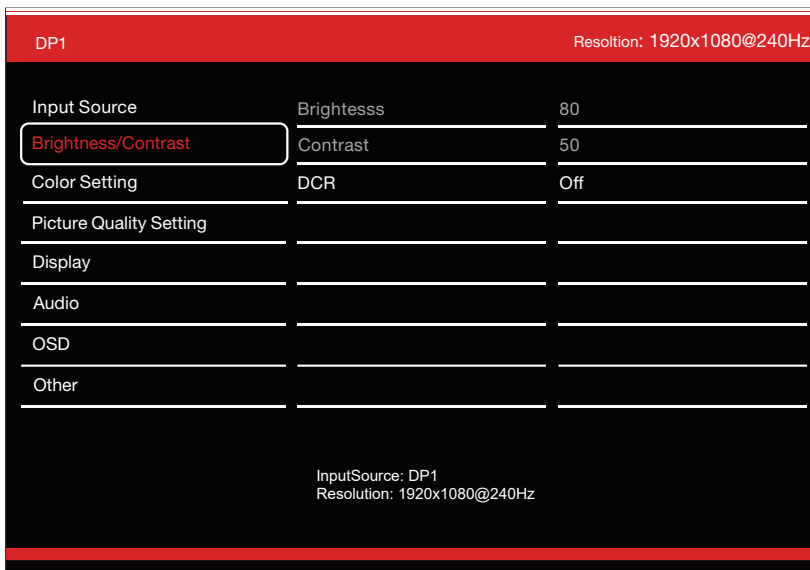

Brightness:Change the display brightness value from 0 to 100.

Contrast:Adjust the display contrast value from 0 to 100.

DCR:Turn the Dynamic Contrast Ratio feature On or Off.

C . Color Settings

DP1		Resolution: 1920x1080@240Hz
Input Source	Gamma	2.2
Brightness/Contrast	Picture Mode	Standard
Color Setting	Color Temperature	Warm
Picture Quality Setting	Hue	50
Display	Saturation	50
Audio	Low Blue Light	0
OSD		
Other		
InputSource: DP1 Resolution: 1920x1080@240Hz		

Gamma: Change the display Gamma Value to:2.0,2.2,2.4.

PictureMode: Change the picture mode to Standard/photo/movie/game/FPS/RTS.

Color Temperature: Change the color temperature to normal/warm/cool/user.

Hue: Change the display Hue value from 0 to 100.

Saturation: Change the display Saturation value from 0 to 100.

Low Blue Light: Change the display blue light from 0 to 100.

D . Picture Quality Settings

DP1		Resolution: 1920x1080@240Hz
Input Source	Sharpness	50
Brightness/Contrast	Response Time	Off
Color Setting	Noise Reduction	Off
Picture Quality Setting	Super Reduction	Off
Display	Dyamic Luminous Control	Off
Audio		
OSD		
Other		
InputSource: DP1 Resolution: 1920x1080@240Hz		

Sharpness: Change the display Sharpness value from 0 to 100.

Reponse Time: Select the Reponse time Value from Low,Middle,High or turn it Off.

Noise Reduction: Select the Noise Reduction Value from Low,Middle,High or turn it Off.

Super Reduction: Select the Super Reduction Value from Low,Middle,High or turn it Off.

Dyamic Luminous Cantrol: Select the Dyamic Luminous Cantrol Value from On or turn it Off.

E . Display

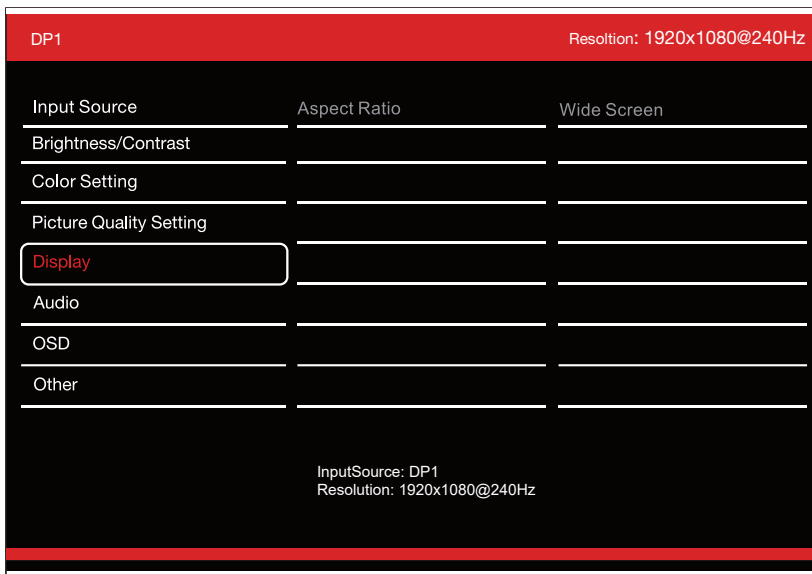

Aspect Ratio: Change the image aspect ratio to Wide Screen,4:3,1:1,Auto.

F . Audio

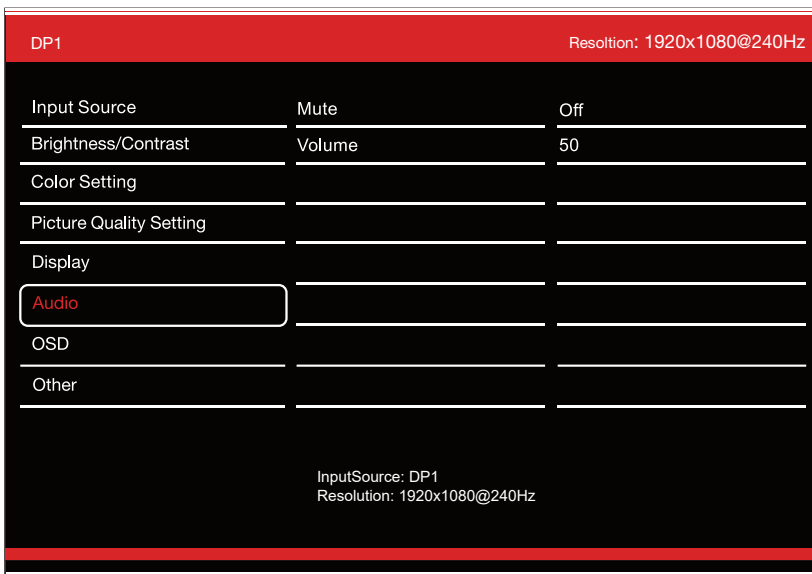

Mute: Turn On or Off to mute the audio source.

Volume: Change the audio source volume from 0 to 100.

G . OSD

DP1		Resolution: 1920x1080@240Hz
Input Source	Language	English
Brightness/Contrast	OSD H-Position	50
Color Setting	OSD V-Position	50
Picture Quality Setting	OSD Transparency	20
Display	OSD Time Out	20
Audio	OSD Rotation	Normal
OSD		
Other		

InputSource: DP1
Resolution: 1920x1080@240Hz

Language:Change the OSD Menu display language.

OSD H Position:Change the horizontal position of the OSD Menu.

OSD V Positon:Change the vertical position of the OSD Menu.

OSD Transparency:Change the transparency value of the OSD Menu from 0 to 100.

OSD Timer:Change how long the OSD Menu is on before it automatically exits.

OSD Rotation:Rotate the OSD Menu.

H. Other

DP1		Resolution: 1920x1080@240Hz
Input Source	FreeSync(Adaptive Sync)	Off
Brightness/Contrast	HDR	Off
Color Setting	MPRT	Off
Picture Quality Setting	Flicker Free	Off
Display	LightEffect	Off
Audio	Reset	
OSD		
Other		

InputSource: DP1
Resolution: 1920x1080@240Hz

FreeSync: Turn FreeSync On or Off.

HDR: Turn HDR On(requires HDMI 2.0 input).

MPRT: Turn MPRT On or Off.

Flicker Free: Turn Flicker Free On or Off.

LightEffect: Turn LightEffect On or Off..

Reset: Restore factory default settng.

SPECIFICATION

Model	TM32RFA
Screen Size	32"
Aspect Ratio	16:9
Backlight	LED
Brightness	300cd/m ²
Panel Type	VA
Resolution	1920x1080
Refresh Rate	240Hz
Response Time	MPRT 1ms
Viewing Angle	178°/178° (CR>10)
Contrast Ratio	1000:1
VESA Mounting	100x100mm
Colours	16.7M (8-bit)
AMD FreeSync	Yes
G-Sync	Yes
HDR	Yes
MPRT	Yes
Signal Input	DPx2+HDMIx2
Audio	out
Speakers	2x3W
Cables	
Power Cable	Yes
HDMI2.0 Cable	Yes
Additional Functions	
Low Blue Light	Yes
Flicker Free	Yes
Power Consumption	≤45W
Power Type	DC 12V, 5A

EMAIL: INFO@TWISTEDMINDS.CO

WEBSITE: WWW.TWISTEDMINDS.CO