

# 23.8" CURVED LED GAMING MONITOR



## **Instruction Manual**

Please read this manual thoroughly before use and keep it handy for future reference

# **GENERAL INFORMATION**

## **Dear Customer,**

Thank you for having purchased this product. This document describes how to install and use the LCD color monitor. Read this manual which contains information for correct, safe use carefully. Keep this manual at hand so that you can refer to it when needed.

## **PRODUCT DESCRIPTION AND TYPE OF USE**

The LCD color monitor presents a very rugged structure. It is designed for continuous operation and can be used in closed circuit TV systems without risks of excessive fatigue. The Flat Panel Display has an active matrix, thin-film transistor (TFT), liquid crystal display (LCD).

## **GENERAL FEATURES**

- Display area
- Wallmounting with not included bracket
- Wall mounting VESA standard 75\*75mm (Not included bracket)
- One composite, one DP, one HDMI
- Wide inclination to allow viewing either from a seated position or standing up and when moving from one position to the other
- Multilingual OSD menu for easy setting and optimization of the display

## **OPENING THE BOX**

Check that the packing and the contents are not visibly damaged. Contact the retailer immediately if parts are either missing or damaged. Do not attempt to use the device in this case. Send the product back in its original packing if it is damaged.

## **CONTENTS OF THE BOX**

- LCD monitor
- Power Adaptor and Power cable
- DP cable
- User's manual

Important Note: Accessories may be changed without prior notice.

# WARNINGS

## POWER

- Only use the power unit provided to power the device. Check mains rating before plugging the power unit in.
- Do not pull the cable to unplug the device.

## SAFETY PRECAUTIONS

- Keep the device away from rain and humidity to prevent risk of fire and electrocution. Do not introduce material (solid or liquid) inside. If this should accidentally occur, disconnect the device from the mains and have it inspected by qualified personnel.
- Never open the device. In all cases, contact the qualified personnel or authorized service center for repairs.
- Keep the device away from children, to prevent accidental damage.
- Do not touch the device with wet hands to prevent electrical shock or mechanical damage.
- Do not use the device if it should fall or the external casing is damaged. Risk of electrocution if the device is used in such conditions. Contact the retailer or authorized installer.
- It is advisable to disconnect the power wire if the monitor is not used for a certain time.

## INSTALLATION PRECAUTIONS

- To prevent overheating the device, arrange it in a position allowing the flow of air through the slots in the casing. Ensure at least 5 cm of free space when installing inside a rack. For the same reason, do not install near sources of heat, such as radiators or hot air ducts. Keep away from direct sunlight. Do not install in areas subject to excessive dust, mechanical vibrations or shocks.
- Do not arrange this device on an unstable surface, such as a tottering or slanted table. The device could fall causing injury or mechanical failures.
- Do not install the device in a place where it could be exposed to humidity or water. Do not direct a jet of water onto the device: risk of fire, electrocution or mechanical failure.
- Stop using the device if water or other material should penetrate inside: risk of fire and electrocution. Contact the retailer or authorized installer.
- Slots and openings in the cabinet are provided for ventilation. These openings must not be blocked or covered.
- Do not place heavy or heat generating objects on top of the device: this could damage the casing and/or increase internal temperature causing faults.
- Do not cover the device with a cloth while it is running to prevent deforming the external casing and overheating the internal parts: risk of fire, electrocution and mechanical failure.
- Keep magnets and magnetized objects away from the device to prevent faults.
- Do not use the device in presence of smoke, vapor, humidity, dust or intense vibrations.
- Wait for a while before operating a device immediately after transporting it from a cold place to a warm place and vice versa. Wait on average for three hours: this will allow the device to adapt to the new ambient (temperature, humidity, etc.).
- The monitor is provided with a plastic base and rubber feet. It can be positioned on a horizontal surface, such as a desk or a table. Make sure that the device is fastened firmly and that it is not resting on unstable supports or surfaces. Dropping could cause severe injury and damage the device.
- Remember to adjust the brightness and contrast to obtain a perfect image.
- The monitor can also be installed on the wall by means of a bracket (not provided).

### **CLEANING THE DEVICE**

- Rub delicately with a dry cloth to remove dust and dirt.
- Dip the cloth in neutral detergent if dirt cannot be eliminated with a dry cloth alone.
- Do not use volatile liquids (such petrol, alcohol, solvents, etc.) or chemically treated clothes to clean the device to prevent deformation, deterioration or scratches to the paint finish.

### **PRIVACY AND COPYRIGHT**

- The LED monitor is a device for Gaming. Recording of images is subject to the laws in force in your country. Recording of images protected by copyright is forbidden.

Product users shall be responsible for checking and respecting all local rules and regulations concerning monitoring and recording video signals. The manufacturing SHALL NOT BE LIABLE for use of this product not in compliance with the laws in force.

# Technical Drawing

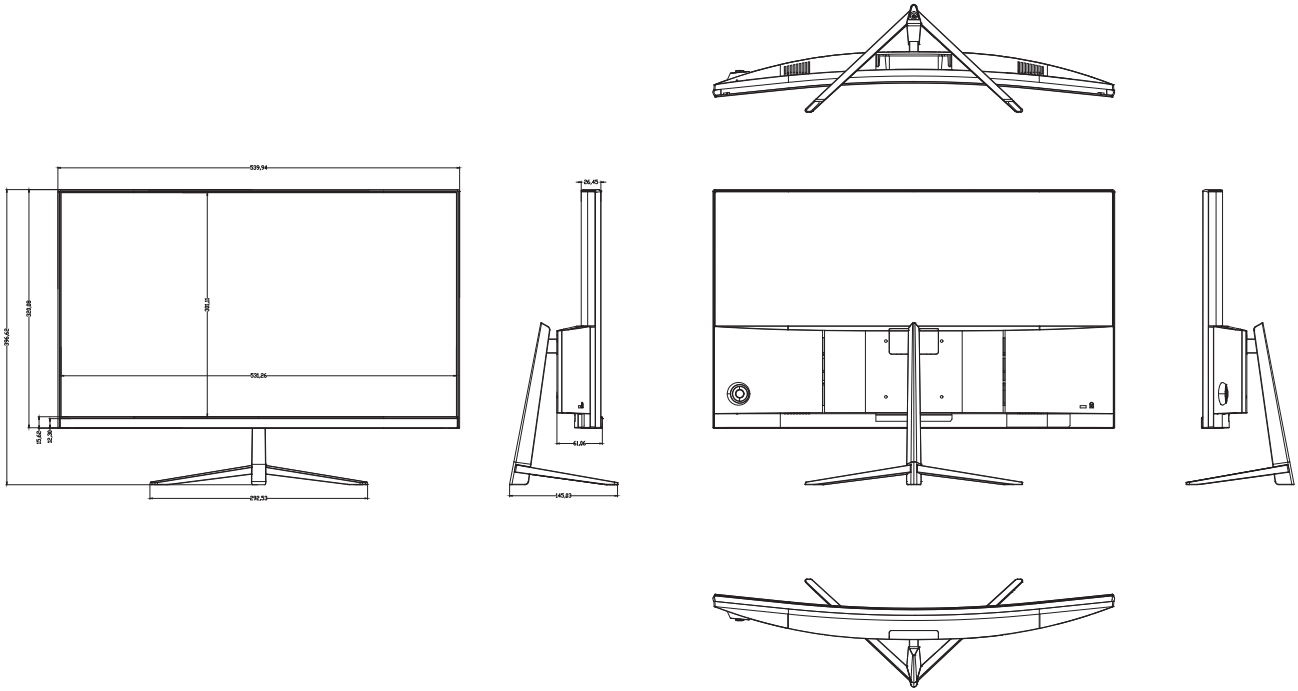

# Monitor Inputs

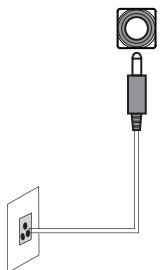
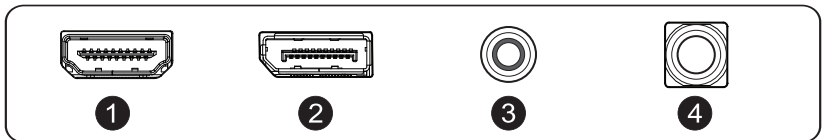

- ① HDMI 2.0 (Support FHD 200Hz, FreeSync, HDR)
- ② DP 1.4 (Support FHD 200Hz, G-Sync, MPRT)
- ③ AUDIO OUT
- ④ Power (DC 12V, 3A)

**\*WARNING:**  
Always use the appropriate power cord.

# Accessories

## PACKAGE INCLUDES

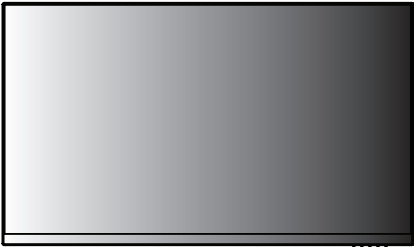

23.8inch Monitor

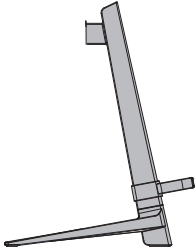

Stand

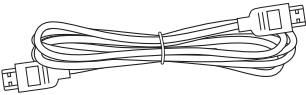

DP Cable

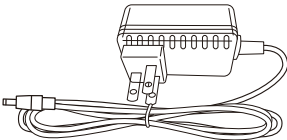

Power Adapter  
and Power Cable

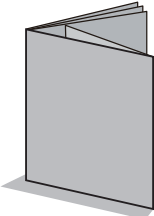

User Manual

## Control Panel

● The color and shape of parts may differ from what is shown. Specifications are subject to change without notice to improve quality.

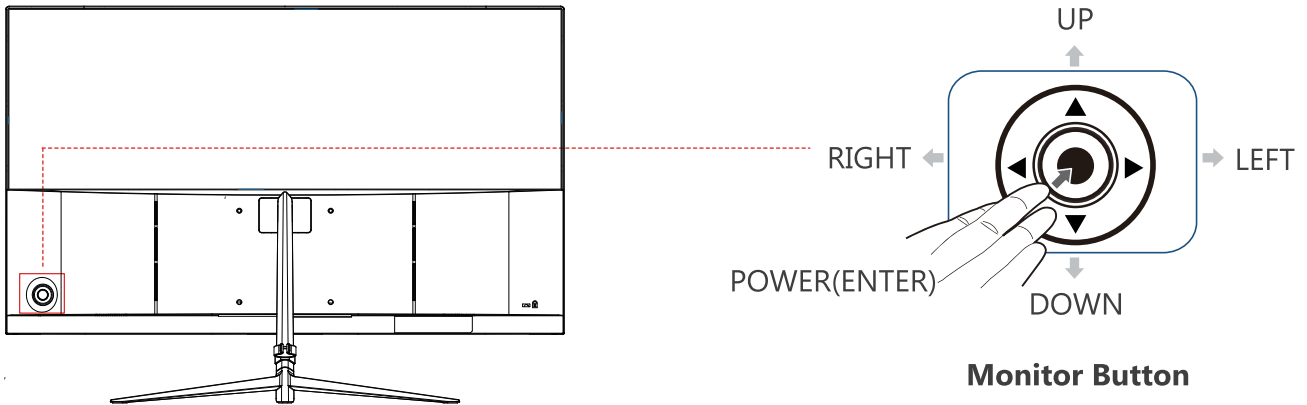





### ● Monitor Button

Multi-directional button that helps navigate.

- The button is located on the rear left side of the product. The button can be used to move up, down, left or right, or as Enter.

### ● How to Use the Monitor Button

1. When the monitor displays nothing, the Monitor Button could be used as below.



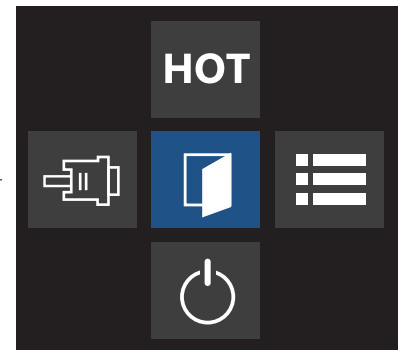
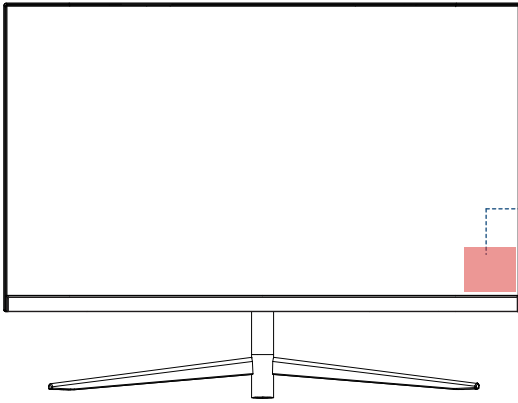

Monitor Button	Action
 POWER / ENTER	Press and hold for 3 seconds to power off
 LEFT / RIGHT	Volume control shortcut button
 UP	Aspect Ratio zoom shortcut button
 DOWN	Cross Aiming Shortcut Button (During Gaming)



● **Function Key Guide**

Press the Monitor Button "Enter" key when the screen is turned on. The Function Key Guide will appear. To access the onscreen menu when the guide is displayed, press the corresponding direction button again.

- Function Key Guide may vary depending on the function or product model. Please refer to the actual product.

Icon	Action
	Selects by moving the monitor button in the function key guide screen. Press to enable or disable ECO Mode.
	Selects to change the input signal by moving the monitor button in the Function Key Guide screen. A message will appear on the top left corner of the screen if the input signal has been changed.
	Selects by moving the monitor button in the function key guide screen. The OSD (On Screen Display) of your Monitor's feature appears.
	Selects to turn the Monitor off by moving the monitor button in the function key guide screen.

● **Video Source Selection Button**

To select the desired signal ("Auto Select", "DP/HDMI") press the Monitor Button to select the desired item. Press the "POWER" button to confirm.





# OSD MENU CONTROLS

## A. Luminance

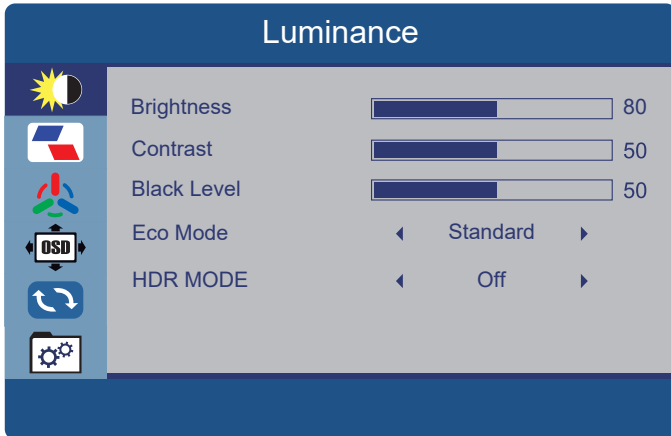

### Brightness

Allows the adjustment of the image brightness, according to ambient light in the room. Value “0-100”.

### Contrast

Allows the adjustment of the image brightness, according to ambient light in the room. Value “0-100”.

### Black Level

Allows adjustment of the Black Level of the OSD, value “0-100”.

### Eco Mode

Allows selection of image settings between the following: Standard, Text, Movie, Game, FPS, RTS.

### HDR MODE

Allows the HDR Mode of the picture to be turned ON and OFF.

## B. Image Setup



### FreeSync

Allows the FreeSync Mode to be turned ON and OFF.

### MPRT

Allows the MPRT Mode to be turned ON and OFF.

## C. Color Setup

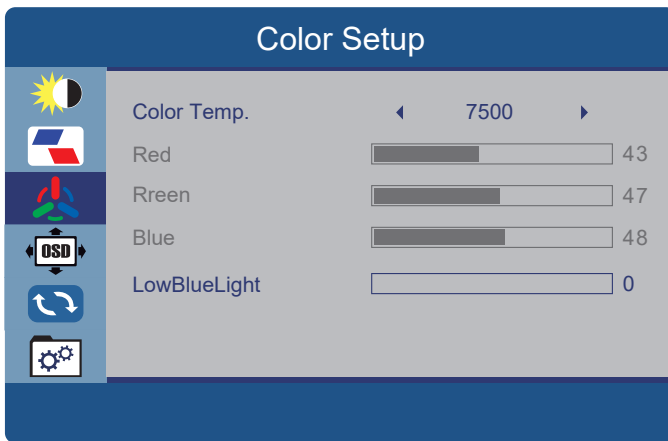

### **Color Temp.**

Allows adjustment of the colour settings between the following options: 6500, 9300, 7500, User .

### **Red**

Allows adjustment of the red element of the image.

### **Green**

Allows adjustment of the green element of the image.

### **Blue**

Allows adjustment of the blue element of the image.

### **Low Blue Light**

Allows adjustment of the Low Blue Light of the OSD, value "0-100".

## D. OSD Setup

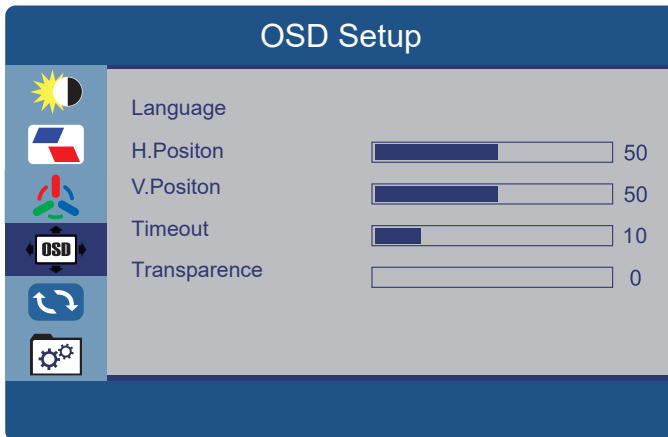

### Language

Allows selection of desired language: english, french, turkish, italian, spanish, portuguese, chinese, dutch, japanese, german, polish, and korean.

### H.Position

Allows adjustment of the horizontal position of the OSD.

### V.Position

Allows adjustment of the vertical position of the OSD.

### Timeout

Allows adjustment of the duration of the OSD, value "5-100".

### Transparence

Allows adjustment of the transparence of the OSD, value "0-100".

## E. Reset

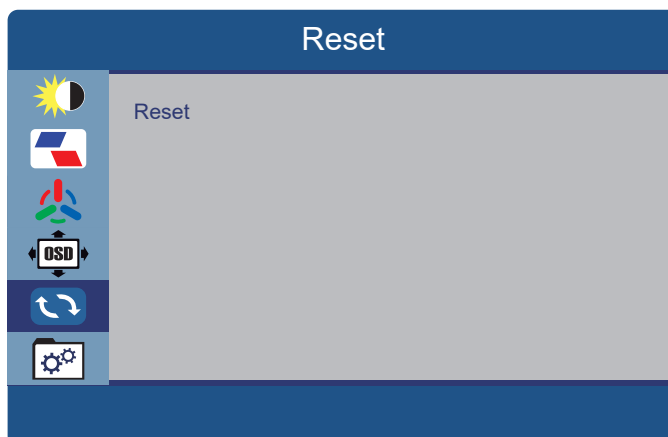

### Reset

Returns the monitor to its factory default settings.

## F.Extra

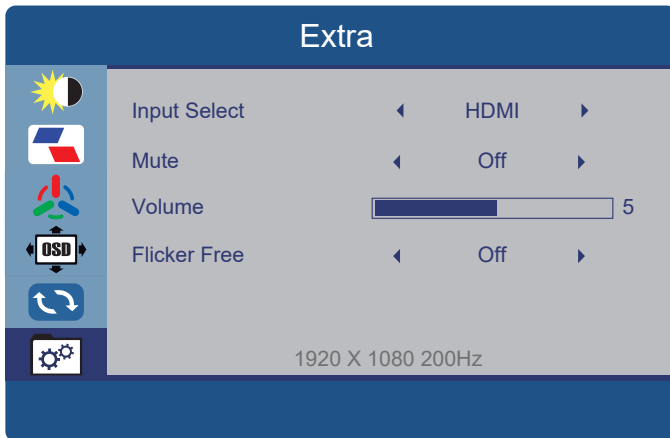

### **Input Select**

Allows user to choose the signal source of the display "HDMI and DP".

### **Mute**

Allows Mute to be turned ON and OFF.

### **Volume**

Allows adjustment of the Volume of the OSD, value "0-10".

### **Flicker Free**

Allows Flicker Free to be turned ON and OFF.

## Specification

Model	TM24RFA
Size	23.8"
Panel Type	VA Panel
Refresh	200Hz
Response Time (Max)	MPRT 1ms
Resolution	1920x1080
Aspect Ratio	16:9
Pixel Pitch	0.27156(H)×0.27156(V)
Viewing Angle	178°(H)/178°(V)
Brightness (Max)	300cd/m <sup>2</sup>
Display Color	16.7 Million Colors
Ports	HDMI2.0 x 1 / DP1.4 x 1 / AUDIO x 1
Speaker	3Wx2
Function	FreeSync, G-Sync, MPRT, HDR
Safety & EMC Certification	CE / RoHS
Power Type	DC 12V/3A
Power Source	100~240V AC
Power Consumption	Typical 32W

EMAIL: [INFO@TWISTEDMINDS.CO](mailto:INFO@TWISTEDMINDS.CO)

WEBSITE: [WWW.TWISTEDMINDS.CO](http://WWW.TWISTEDMINDS.CO)



