

23.8" FLAT LED GAMING MONITOR



Instruction Manual

Please read this manual thoroughly before use and keep it handy for future reference

English	P.1
بالعربية	P.11
Türkçe	P.21
Deutsch	P.31
Français	P.41
Español	P.51
Nederlands	P.61
Português	P.71

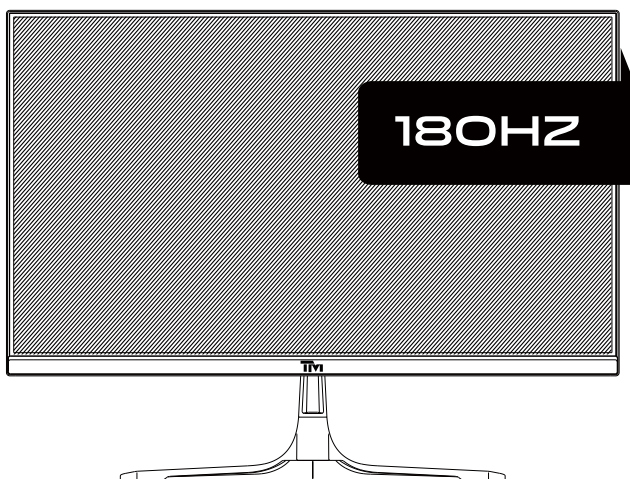

WWW.TWISTEDMINDS.CO



- Keep the monitor away from water sources or damp places, such as bath rooms, kitchens, basements and swimming pools.
- Make sure the monitor is placed on a flat surface. If the monitor falls down, it may cause human injury or device damage.
- Store and use the monitor in a cool, dry and well ventilated place, and keep it away from emission and heat sources.
- Do not cover or block the vent hole in the rear casing, and do not use the product on a bed, sofa, blanket or similar objects.
- The range of the supply voltage of the monitor is printed on the label on the rear casing. If it is impossible to determine the supply voltage, please consult the distributor or local power company.
- If the monitor will not be used for a long period, please cut off the power supply to avoid electric shock in rainy days and damage due to abnormal supply voltage.
- Please use a reliable earthing socket, do not overload the socket, or it may cause fire or electric shock.
- Do not put foreign matters into the monitor, or it may cause short circuits resulting fire or electric shock.
- Do not disassemble or repair this product by self to avoid electric shock. If faults occur, please contact the after-sales service directly.
- Do not pull or twist the power cable forcedly.
- There is a polarizer layer (not a protective film) on the surface of the screen. Do not peel it off, or the product may be damaged and the warranty will be invalid.

Product introduction

Packing list

- Please check that the package of the monitor contains all parts. If any part is lost, please contact the distributor.
- The color and shape of parts may vary with models. Figures in this User Manual are for reference only.
- Wires supplied may vary with purchased products. Figures in this User Manual are for reference only.



Monitor



Stand



Base

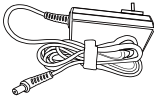

Power adapter x1



Screws (3pcs)



HDMI signal cable



Instructions

- Redundant screws can be used as spare screws.

Installation

Installation of base

1. Take out the Stand Neck and base, and assemble the base with a screw.

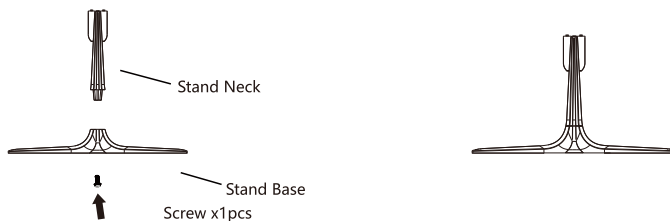

2. Insert the stand neck into mounting hole , then assemble the stand neck with a screw.

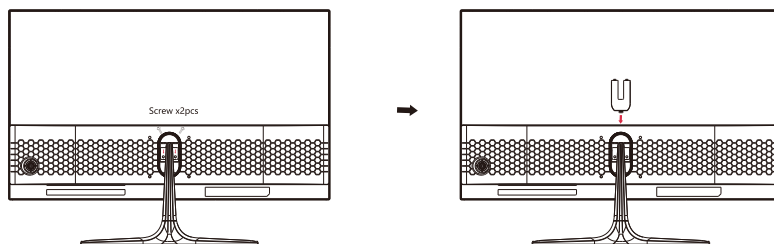

3. After assembly, simply hold the stand with hand to stand the monitor upright.

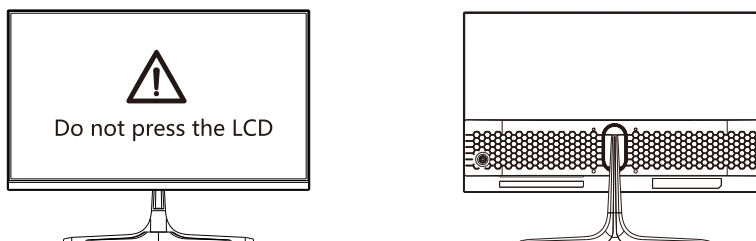

! Note: During standing of the whole monitor, do not press the liquid crystal screen with hand to avoid damage to the screen.

Adjusting the monitor

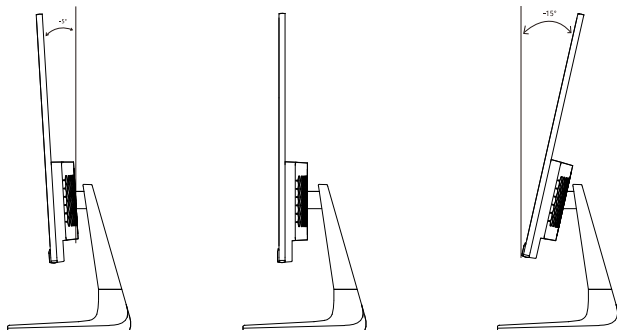

Tilting angle

$-5.0^{\circ}(\pm 2.0^{\circ})$ - $+15^{\circ}(\pm 2.0^{\circ})$

Description of buttons

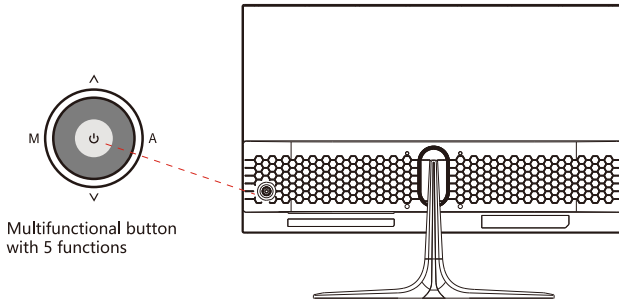

Usage of multifunctional button control key

M	Menu	Activate and confirm the OSD Menu
^	Preset Mode	Select items and adjust parameters upwards in the menu.
v	Signal Switch	Select items and adjust parameters downwards in the menu.
A	Back/Exit	When in the menu, go back or log out / Game Plus Crosshair
⏻	Power Button	Press once to switch on the power, press and hold for 3 seconds to switch off the power.

Explanation of indicators

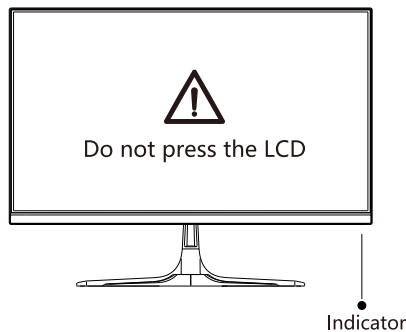

Indicator: Steady blue light indicates the power is on and the monitor runs normally. Steady red light indicates no video source and no horizontal or vertical signal detected or low voltage. Please make sure your computer is turned on and all video cables are fully plugged in and/or connected.

Cable connection:

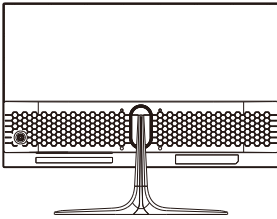

* The bottom interface configuration at the back of the monitor varies with products.

* Note: If the power cable or signal cable is damaged, you must replace it with special soft cables or special components purchased from the manufacturer or maintenance department.

HDMI interface

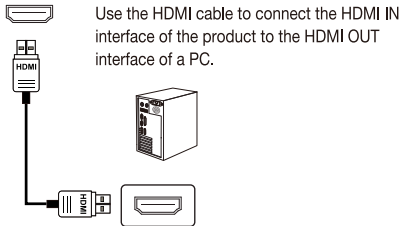

Use the HDMI cable to connect the HDMI IN interface of the product to the HDMI OUT interface of a PC.

DP interface

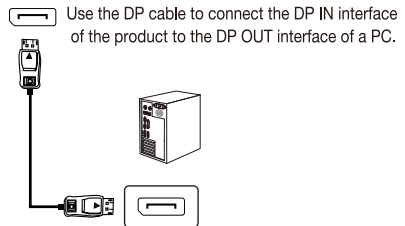

Use the DP cable to connect the DP IN interface of the product to the DP OUT interface of a PC.

AUDIO OUT

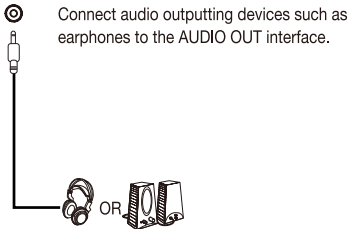

Connect audio outputting devices such as earphones to the AUDIO OUT interface.

Power Adapter

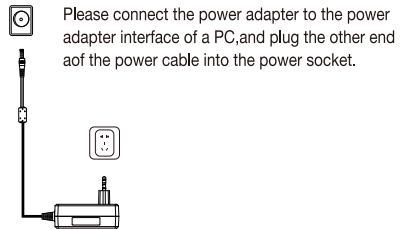

Please connect the power adapter to the power adapter interface of a PC, and plug the other end of the power cable into the power socket.

Menu description

- The color and shape of the OSD menu of the actual computer may be slightly different from them shown in the figure.
- Specifications of the OSD menu may change with improvements of functions without prior notice.

The screen display (OSD) menu can be used to adjust settings of the monitor and is shown on the screen after the monitor is powered on and the M button is pressed.

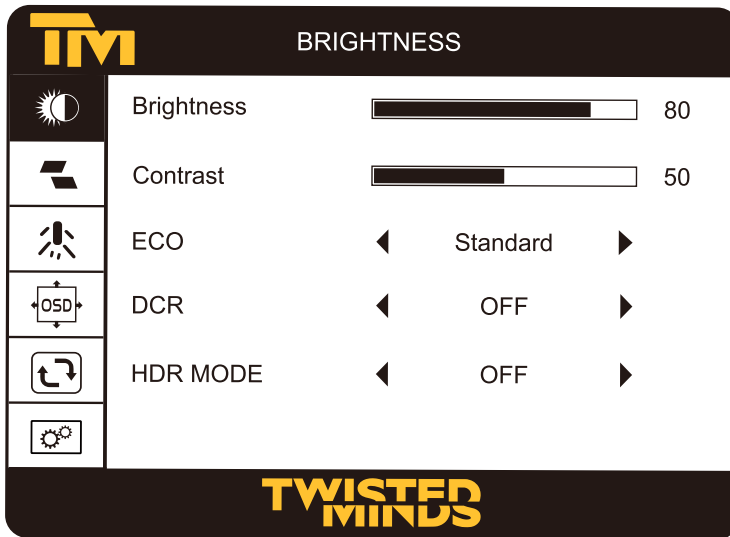

M	Menu	Activate and confirm the OSD Menu
^	Preset Mode	Select items and adjust parameters upwards in the menu.
v	Signal Switch	Select items and adjust parameters downwards in the menu.
A	Back/Exit	When in the menu, go back or log out / Game Plus Crosshair
⏻	Power Button	Press once to switch on the power, press and hold for 3 seconds to switch off the power.

- Functions of the monitor vary with models, and the functions in this manual are for reference only.

LUMINANCE	BRIGHTNESS	0-100
	CONTRAST	0-100
	ECO	STANDARD/RTS/FPS/TEXT/MOVIE/GAME
	DCR	OFF/ON
	BLACK LEVEL	0-100
IMAGE	ASPECT	WIDE/4:3
COLOR TEMP.	COLOR TEMP.	NORMAL/COOL/USER/WARM
	Red	0-100
	Green	0-100
	Blue	0-100
	LOW BLUE LIGHT	0-100
OSD SETTING	LANGUAGE	12 COUNTRIES LANGUAGE(DEFAULT:ENGLISH)
RESET	RESET	
	HDR	OFF/ON/AUTO
MISC.	SIGNAL SOURCE	AUTO/HDMI/DP
	MUTE	OFF/ON
	VOLUME	0-100
	ADAPTIVE SYNC	OFF/ON
	OD	OFF/ON
	MPRT	OFF/ON

Basic parameters

Product Name		23.8 inches Gaming monitor
Product model		TM24FHD180IPS
Screen Size		23.8 inches (cm)
Aspect Ratio		16:9
Viewing Angle		178°(H) / 178°(V)
Display Area (H*V)		(H)*(V) mm
Contrast ratio		(TYP)
Colors		16.7M
Resolution		1920*1080
Maximum refresh rate		180Hz
Power specifications		DC 12V --- The standard voltage and current may vary with countries, please refer to the label at the back of the product.
Product Dimentions	Without base	mm/ weight x kg
	With base	mm/ weight x kg
Tilting angle		Forward titling: 5°±2°; Backward tilting: 15°±2°
Height range		NA
Rotation angle		NA
Vertical angle		NA
Environmental conditions	Action	Temperature: 0°C ~ 40°C (32°F ~ 104°F) Humidity: 10%~90% RH (non-condensing)
	Storage	Temperature: -20° ~ 60° (-4°F ~ 140°F) Humidity: 5%~95% RH (non-condensing)