



PNOZ m B1

PILZ
THE SPIRIT OF SAFETY

- ▶ Configurable, safe small controllers PNOZmulti 2

This document is the original document.

All rights to this documentation are reserved by Pilz GmbH & Co. KG. Copies may be made for the user's internal purposes. Suggestions and comments for improving this documentation will be gratefully received.

Source code from third-party manufacturers or open source software has been used for some components. The relevant licence information is available on the Internet on the Pilz homepage.

Pilz®, PIT®, PMI®, PNOZ®, Primo®, PSEN®, PSS®, PVIS®, SafetyBUS p®, SafetyEYE®, SafetyNET p®, the spirit of safety® are registered and protected trademarks of Pilz GmbH & Co. KG in some countries.



SD means Secure Digital

1	Introduction	5
1.1	Validity of documentation	5
1.2	Using the documentation	5
1.3	Definition of symbols	5
2	Overview	7
2.1	Range	7
2.2	Unit features	7
2.3	USB memory	7
2.4	Front view	8
3	Safety	9
3.1	Intended use	9
3.2	System requirements	10
3.3	Safety regulations	10
3.3.1	Safety assessment	10
3.3.2	Use of qualified personnel	10
3.3.3	Warranty and liability	10
3.3.4	Disposal	10
3.3.5	For your safety	11
4	Function description	12
4.1	Integrated protection mechanisms	12
4.2	Functions	12
4.3	System reaction time	12
4.4	Detection of shorts across contacts	13
4.5	Block diagram	14
4.6	Diagnostics	14
4.7	Ethernet interface	14
5	Installation	15
5.1	Control cabinet installation	15
5.1.1	Mounting distances	15
5.2	Dimensions in mm	17
5.3	Connecting the base unit and expansion modules	17
6	Commissioning	19
6.1	General wiring guidelines	19
6.2	Connection	19
6.3	Ethernet interfaces	20
6.3.1	RJ45 interfaces ("Ethernet")	20
6.3.2	Requirements of the connection cable and connector	20
6.3.3	Interface configuration	20
6.3.4	RJ45 connection cable	21
6.4	Use USB memory	22
6.5	Load project from PNOZmulti Configurator	22
6.6	Activate project via the display on the base unit	23
6.7	Display settings	23

6.7.1	Operate menu	23
6.7.2	Displays and settings	24
6.7.2.1	Status indicators	25
6.7.2.2	Project menu	26
6.7.2.3	Device Info menu	28
6.7.2.4	Error Stack menu	29
6.7.2.5	Operating Info menu	29
6.7.2.6	Connections menu	30
6.7.2.7	Ethernet menu	30
6.7.2.8	Time menu	32
6.7.2.9	System mode menu	32
6.8	Function test during commissioning	32
7	Operation	33
7.1	LED indicators	33
7.2	Show error stack on the display	34
8	Technical details	35
8.1	Safety characteristic data	37
9	Order reference	38
9.1	Product	38
9.2	Accessories	38

1 Introduction

1.1 Validity of documentation

This documentation is valid for the product PNOZ m B1 from Version HW:01, FW:01.05.

This operating manual explains the function and operation, describes the installation and provides guidelines on how to connect the product.

1.2 Using the documentation

This document is intended for instruction. Only install and commission the product if you have read and understood this document. The document should be retained for future reference.

1.3 Definition of symbols

Information that is particularly important is identified as follows:



DANGER!

This warning must be heeded! It warns of a hazardous situation that poses an immediate threat of serious injury and death and indicates preventive measures that can be taken.



WARNING!

This warning must be heeded! It warns of a hazardous situation that could lead to serious injury and death and indicates preventive measures that can be taken.



CAUTION!

This refers to a hazard that can lead to a less serious or minor injury plus material damage, and also provides information on preventive measures that can be taken.



NOTICE

This describes a situation in which the product or devices could be damaged and also provides information on preventive measures that can be taken. It also highlights areas within the text that are of particular importance.



INFORMATION

This gives advice on applications and provides information on special features.

2 Overview

2.1 Range

- ▶ Base unit PNOZ m B1
- ▶ Terminator
- ▶ Documentation on data medium
- ▶ USB memory

2.2 Unit features

Application of the product PNOZ m B1:

Base unit of the configurable control system PNOZmulti 2

The product has the following features:

- ▶ Can be configured in the PNOZmulti Configurator
- ▶ Support for module programs
- ▶ 4 test pulse outputs to detect shorts between the inputs
- ▶ Backlit display for:
 - Status information
 - Device information
 - Diagnostics
 - Activate project
 - Ethernet settings
 - System's date and time
 - Stop and start device
- ▶ Multifunction switch for menu control
- ▶ Ethernet interface with switch
- ▶ LED indicator for:
 - Operating status
 - Error messages
 - Diagnostics
 - Supply voltage
- ▶ Plug-in connection terminals:
Either spring-loaded terminal or screw terminal available as an accessory (see Order references for accessories).
- ▶ Expansion modules can be connected
(please refer to the document "PNOZmulti System Expansion" for details of the type and number that can be connected)

2.3 USB memory

To save and transfer projects you need the Pilz USB memory that is supplied with the device (plugged into the device).

2.4 Front view

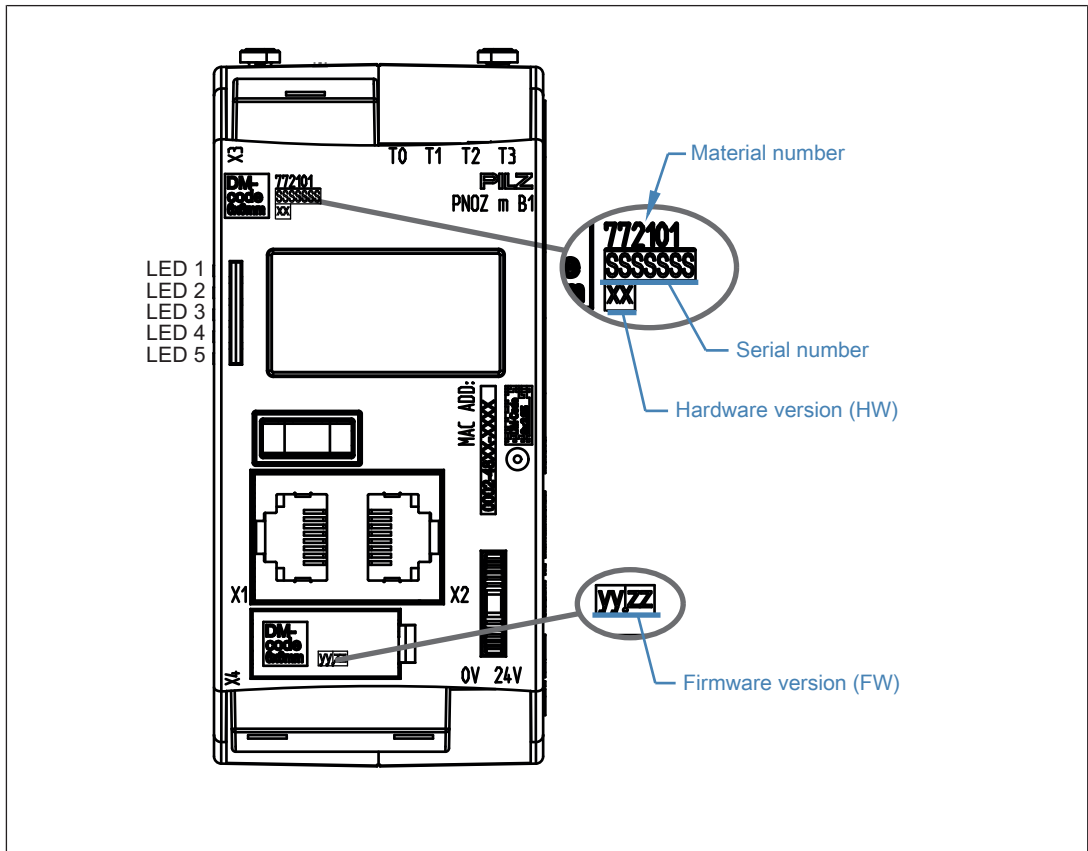

Legend

- X1/X2: Ethernet interface
- X3: Test pulse outputs T0 - T3
- X4: Labelling clip for firmware version
- LED 1: Supply voltage
- LED 2: FS (Initialise/Run/Stop)
- LED 3: ST (Initialise/Run/Stop)
- LED 4: Diag (Project reset/Identify project)
- LED 5: FAULT (IFault/OFault)

To determine the version of the device, please note:

The firmware version number is on the labelling clip. This is also the version number that must be selected in the PNOZmulti Configurator under **Version** during the hardware configuration.

3 Safety

3.1 Intended use

The configurable system PNOZmulti 2 is used for the safety-related interruption of safety circuits and is designed for use in:

- ▶ Emergency stop equipment
- ▶ Safety circuits in accordance with VDE 0113 Part 1 and EN 60204-1



CAUTION!

Inputs and outputs for standard functions must not be used for safety-related applications.

- ▶ The product PNOZ m B1 meets the requirements of the standards EN 81-20, EN 81-22 and EN 81-50, harmonised under the Lifts Directive 2014/33/EU, and the requirements of the standard EN 115-1, harmonised under the Machinery Directive 2006/42/EC.
- ▶ The programmable safety system should be installed in a protected environment that meets at least the requirements of pollution degree 2.
Example: Protected inside space or control cabinet with protection type IP54 and corresponding air conditioning.

The product PNOZ m B1 can be used in furnaces in accordance with EN 298.

Please note:

- ▶ To protect against transient power failures (EN 61000-4-11) the AC power supply used for the system must meet a secondary buffering for 20 ms.
- ▶ If the system is used in a DC network, sufficient overvoltage protection must be ensured. Use external protection elements for overvoltage protection that fulfil at least the following properties:
Installation class 4 / test level 4 in accordance with EN 61000-4-5 (4kV 1.2/50 µs)

The following is deemed improper use in particular

- ▶ Any component, technical or electrical modification to the product,
- ▶ Use of the product outside the areas described in this manual,
- ▶ Use of the product outside the technical details (see [Technical details](#)  35).



NOTICE

EMC-compliant electrical installation

The product is designed for use in an industrial environment. The product may cause interference if installed in other environments. If installed in other environments, measures should be taken to comply with the applicable standards and directives for the respective installation site with regard to interference.

3.2 System requirements

Please refer to the "Product Modifications" document in the "Version overview" section for details of which versions of the PNOZmulti Configurator can be used for this product.

3.3 Safety regulations

3.3.1 Safety assessment

Before using a device it is necessary to perform a safety assessment in accordance with the Machinery Directive.

Functional safety is guaranteed for the product as a single component. However, this does not guarantee the functional safety of the overall plant/machine. In order to achieve the required safety level for the overall plant/machine, define the safety requirements for the plant/machine and then define how these must be implemented from a technical and organisational standpoint.

3.3.2 Use of qualified personnel

The products may only be assembled, installed, programmed, commissioned, operated, maintained and decommissioned by competent persons.

A competent person is a qualified and knowledgeable person who, because of their training, experience and current professional activity, has the specialist knowledge required. To be able to inspect, assess and operate devices, systems and machines, the person has to be informed of the state of the art and the applicable national, European and international laws, directives and standards.

It is the company's responsibility only to employ personnel who

- ▶ Are familiar with the basic regulations concerning health and safety / accident prevention,
- ▶ Have read and understood the information provided in the section entitled Safety
- ▶ Have a good knowledge of the generic and specialist standards applicable to the specific application.

3.3.3 Warranty and liability

All claims to warranty and liability will be rendered invalid if

- ▶ The product was used contrary to the purpose for which it is intended,
- ▶ Damage can be attributed to not having followed the guidelines in the manual,
- ▶ Operating personnel are not suitably qualified,
- ▶ Any type of modification has been made (e.g. exchanging components on the PCB boards, soldering work etc.).

3.3.4 Disposal

- ▶ In safety-related applications, please comply with the mission time T_M in the safety-related characteristic data.
- ▶ When decommissioning, please comply with local regulations regarding the disposal of electronic devices (e.g. Electrical and Electronic Equipment Act).

3.3.5 For your safety

The unit meets all the necessary conditions for safe operation. However, you should always ensure that the following safety requirements are met:

- ▶ This operating manual only describes the basic functions of the unit. Advanced functions are described in the online help for the PNOZmulti Configurator, in the "PNOZmulti Communication Interfaces" document and in "PNOZmulti Special Applications". Only use these functions once you have read and understood the documentation.
- ▶ Please note the "PNOZmulti Installation Manual".
- ▶ You must note the information stated in the "PNOZmulti Safety Manual".
- ▶ Adequate protection must be provided for all inductive consumers.
- ▶ Do not open the housing or make any unauthorised modifications.
- ▶ Please make sure you shut down the supply voltage when performing maintenance work (e.g. exchanging contactors).

4 Function description

4.1 Integrated protection mechanisms

The relay meets the following safety requirements:

- ▶ The circuit is redundant with built-in self-monitoring.
- ▶ The safety device remains effective in the case of a component failure.

4.2 Functions

The function of the inputs and outputs on the control system depends on the safety circuit created using the PNOZmulti Configurator. A USB memory stick is used to download the safety circuit to the base unit. The base unit has 2 microcontrollers that monitor each other. They evaluate the input circuits on the base unit and expansion modules and switch the outputs on the expansion modules accordingly.

The LEDs on the base unit and expansion modules indicate the status of the configurable control system PNOZmulti.

The online help on the PNOZmulti Configurator contains descriptions of the operating modes and all the functions of the control system, plus connection examples.

4.3 System reaction time

Calculation of the maximum reaction time between an input switching off and a linked output in the system switching off is described in the document "PNOZmulti System Expansion".

4.4 Detection of shorts across contacts

4 test pulse outputs that use different test pulses (test pulse 0 (T0) ... test pulse 3 (T3)) are available for detecting shorts between the inputs.

Shorts between inputs are detected if the inputs are connected to different test pulses (test pulse 0 ... test pulse 3).

Pulsing of test pulse outputs T0 ... T3 (typical times):

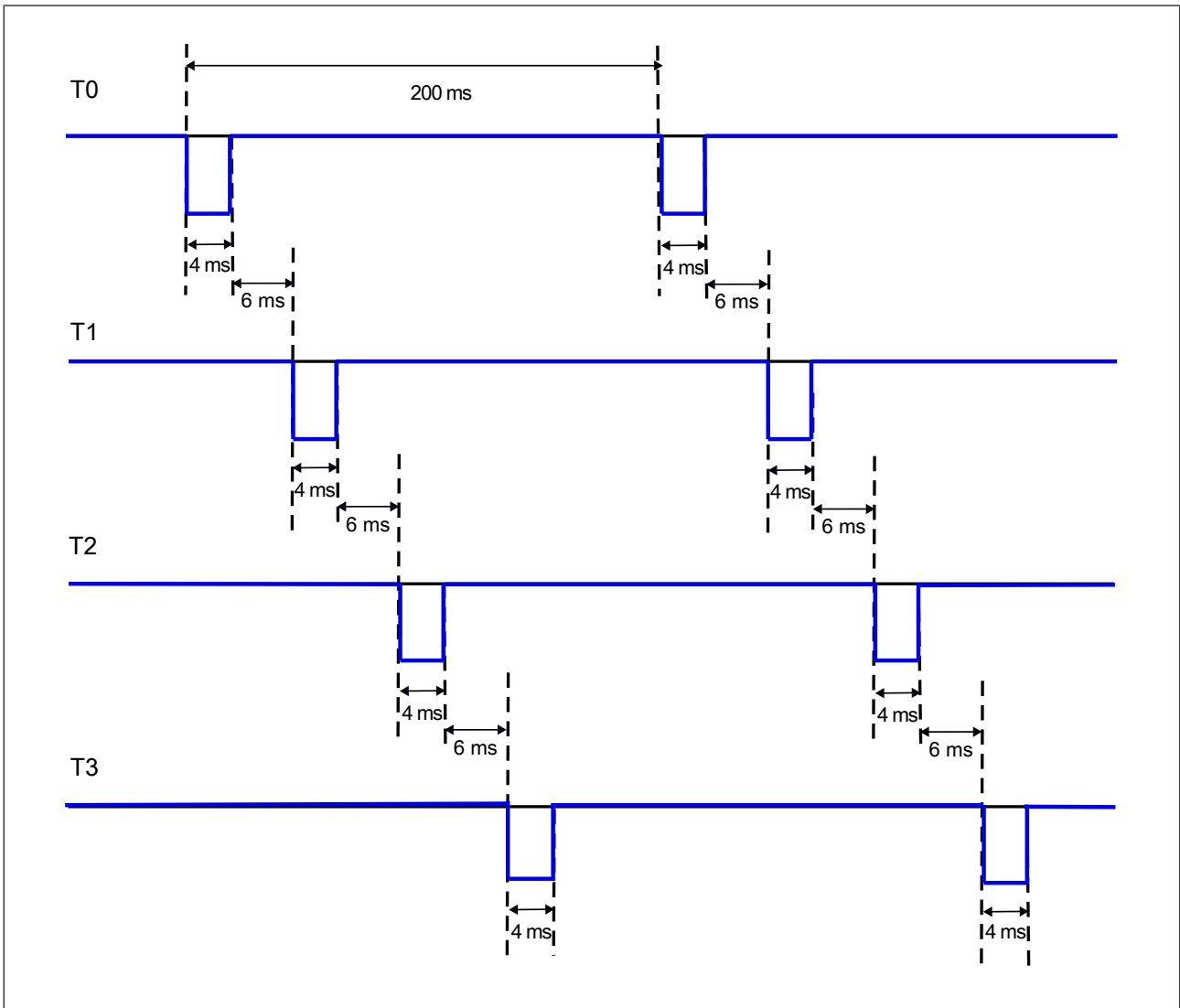

4.5 Block diagram

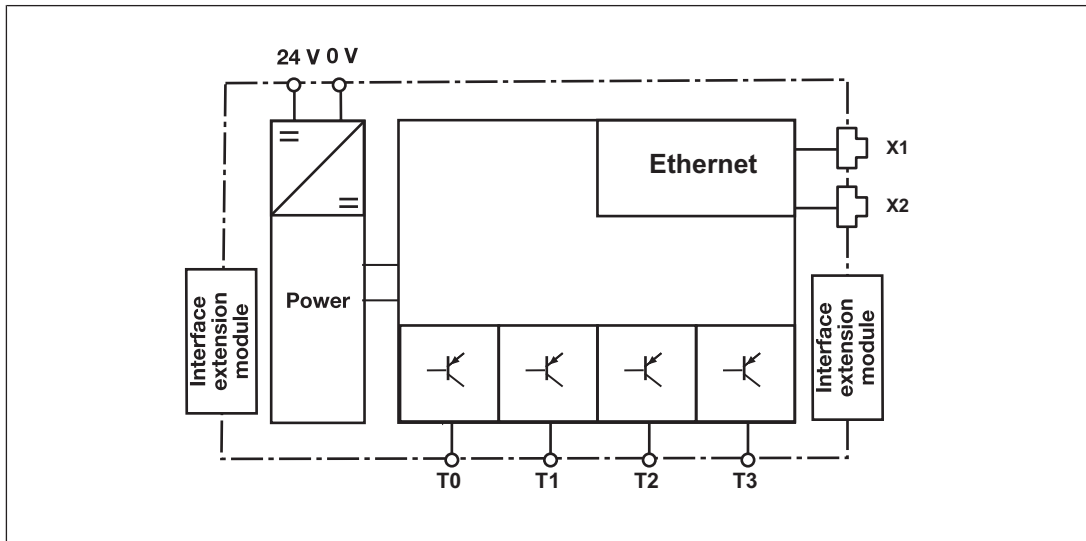

4.6 Diagnostics

The status and error messages displayed by the LEDs are saved in an error stack. This error stack can be shown on the display or can be read from the PNOZmulti Configurator via the Ethernet interface. More comprehensive diagnostics are possible via the interfaces or via one of the fieldbus modules. For more information refer to the document ***PNOZmulti2 Communication Interfaces*** and the ***Online Help for the PNOZmulti Configurator***.

4.7 Ethernet interface

The product PNOZ m B1 has an Ethernet interface to

- ▶ Manage and download projects
- ▶ Read the diagnostic data
- ▶ Set virtual inputs for standard functions
- ▶ Read virtual outputs for standard functions.

Information on diagnostics via the interfaces can be found in the document ***PNOZmulti Communication Interfaces***.

The connection to Ethernet is made via the two 8-pin RJ45 sockets.

The Ethernet interface is configured via the menu in the display (see chapter entitled Displays and settings) or in the PNOZmulti Configurator (see ***Online Help for the PNOZmulti Configurator***).

5 Installation

5.1 Control cabinet installation

- ▶ The unit should be installed in a control cabinet with a protection type of at least IP54.
- ▶ Install the system vertically on to a horizontal mounting rail. The venting slots must face upward and downward. Other mounting positions could damage the safety system.
- ▶ Use the locking elements on the rear of the unit to attach it to a mounting rail.
- ▶ In environments exposed to heavy vibration, the unit should be secured using a fixing element (e.g. retaining bracket or end angle).
- ▶ Open the locking slide before lifting the unit from the mounting rail.
- ▶ To comply with EMC requirements, the mounting rail must have a low impedance connection to the control cabinet housing.



NOTICE

Damage due to electrostatic discharge!

Electrostatic discharge can damage components. Ensure against discharge before touching the product, e.g. by touching an earthed, conductive surface or by wearing an earthed armband.

5.1.1 Mounting distances

With control cabinet installation it is essential to maintain a certain distance from the top and bottom, as well as to other heat-producing devices (see diagram). The values stated for the mounting distances are minimum specifications.

The ambient temperature in the control cabinet must not exceed the figure stated in the technical details. Air conditioning may otherwise be required.

Mounting distances:

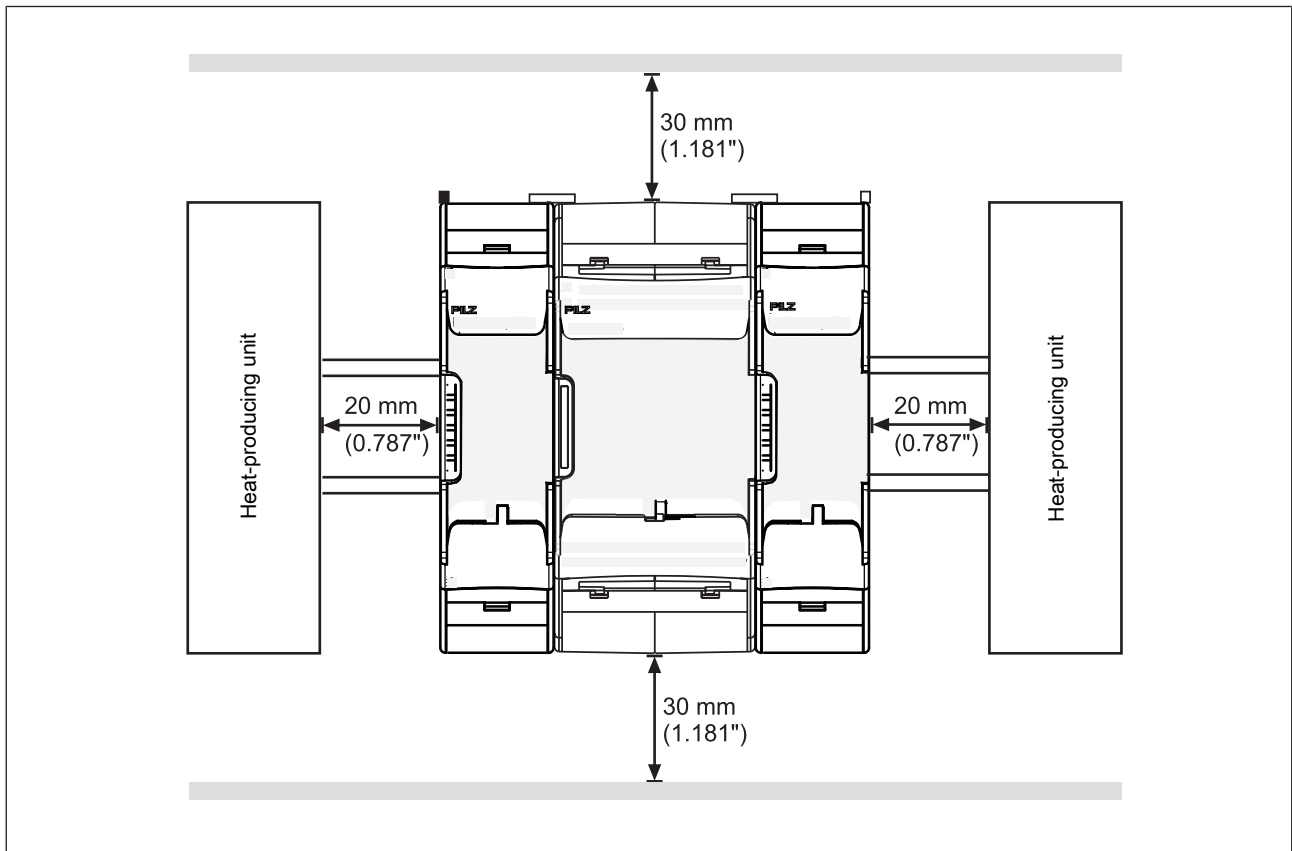

5.2 Dimensions in mm

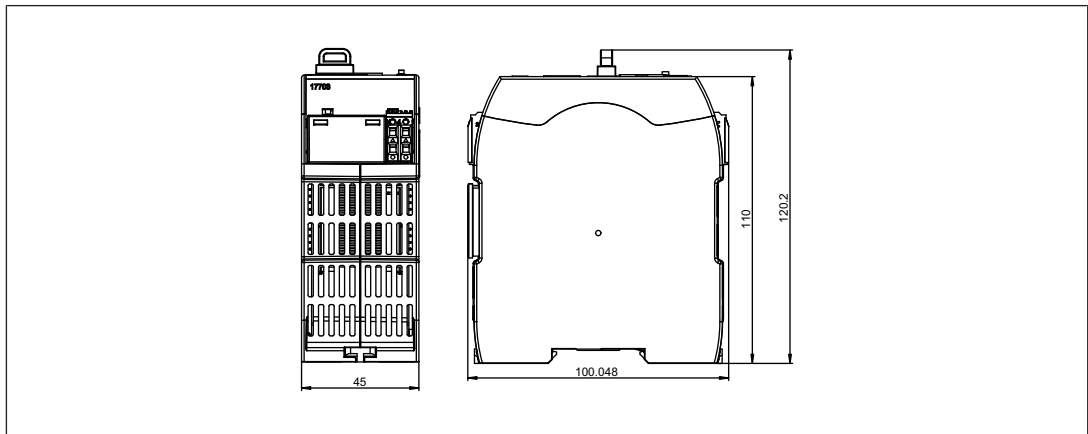

5.3 Connecting the base unit and expansion modules

The position of the expansion modules is defined in the PNOZmulti Configurator. The expansion modules are connected to the left or right of the base unit, depending on the type. Please refer to the document "PNOZmulti System Expansion" for details of the number of modules that can be connected to the base unit and the module types.

The modules are linked via jumpers.

- ▶ Remove the terminator on the side of the base unit.
- ▶ Install the base unit and expansion modules on the mounting rail in the order configured in the PNOZmulti Configurator and connect the units using the jumper supplied.
- ▶ Fit the terminator to the unconnected interfaces on the base unit and expansion module.

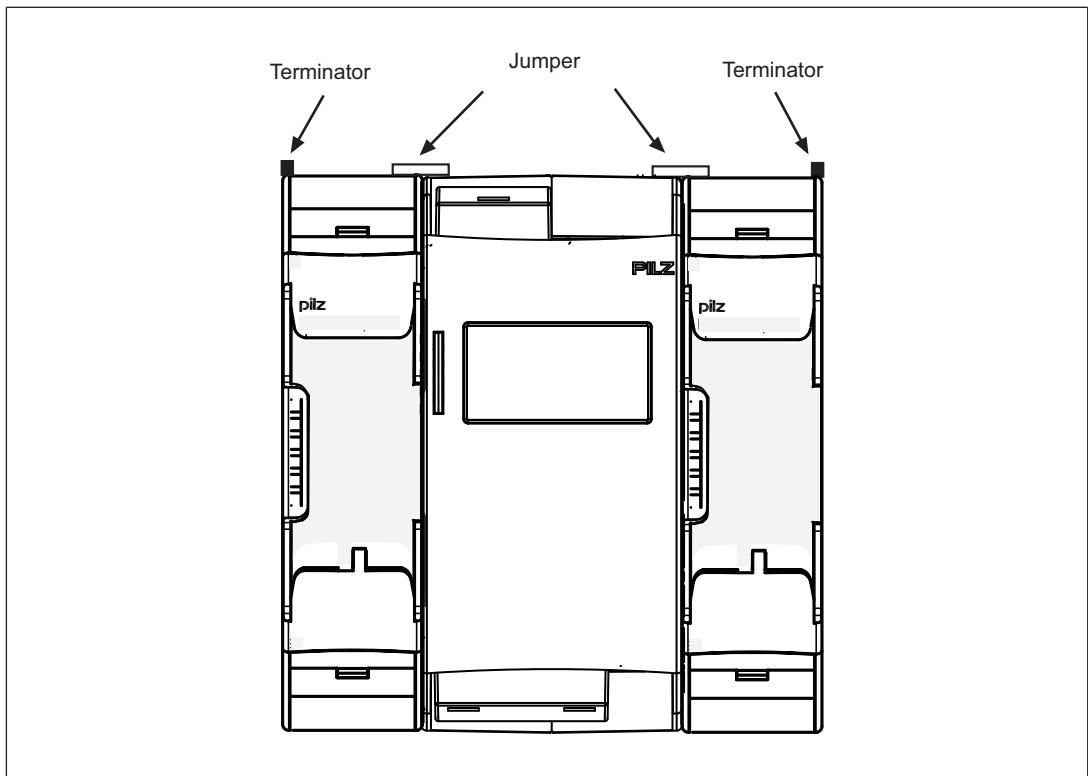



CAUTION!

Only connect the base unit and expansion modules when the supply voltage is switched off.

6 Commissioning

6.1 General wiring guidelines

The wiring is defined in the circuit diagram in the Configurator. There you can select the inputs that are to perform a safety function and the outputs that are to switch this safety function.

Please note:

- ▶ Information given in the [Technical details \[35\]](#) must be followed.
- ▶ Use copper wiring with a temperature stability of 75 °C.
- ▶ Sufficient fuse protection must be provided on all output contacts with inductive loads.
- ▶ The safety system and input circuits must always be supplied by a single power supply. The power supply must meet the regulations for extra low voltages with protective separation (SELV, PELV).
- ▶ Test pulse outputs are used to detect shorts between the inputs. Shorts between inputs are detected if the inputs are connected to different test pulses (test pulse 0 ... test pulse 3). Shorts between inputs of the same module with the same test pulses will not be detected.
- ▶ Test pulse outputs must exclusively be used to activate the inputs. They must not be used to drive loads.
Do not route the test pulse lines together with actuator cables within an unprotected multicore cable.
- ▶ The maximum permitted total current of the test pulse outputs is 640 mA.

6.2 Connection

Procedure:

- ▶ Connect the supply voltage for the control system:
 - Terminal 24 V: + 24 VDC
 - Terminal 0 V: 0 V,
- ▶ Protect the supply voltage as follows:
 - Circuit breaker, characteristic C - 6 A
 - or
 - Blow-out fuse, slow, 6A



CAUTION!

Do not connect or disconnect expansion modules and terminators during operation.

6.3 Ethernet interfaces

6.3.1 RJ45 interfaces ("Ethernet")

Two free switch ports are provided as Ethernet interfaces via an internal autosensing switch. The autosensing switch automatically detects whether data transfer is occurring at 10 Mbit/s or 100 Mbit/s.



INFORMATION

The connected subscribers must support the autosensing/autonegotiation function. If not, the communication partner must be set permanently to "10 Mbit/s, half duplex".

The switch's automatic crossover function means there is no need to distinguish on the connection cable between patch cable (uncrossed data line connection) and crossover cable (crossover data line connection). The switch automatically creates the correct data line connection internally. Patch cable can therefore be used as the connection cable for end devices as well as cascading.

Both Ethernet interfaces use RJ45 technology.

6.3.2 Requirements of the connection cable and connector

The following minimum requirements must be met:

- ▶ Ethernet standards (min. Category 5) 10BaseT or 100BaseTX
- ▶ Double-shielded twisted pair cable for industrial Ethernet use
- ▶ Shielded RJ45 connectors (industrial connectors)

6.3.3 Interface configuration

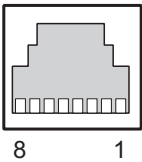
RJ45 socket 8-pin	PIN	Standard	Crossover
	1	TD+ (Transmit+)	RD+ (Receive+)
	2	TD- (Transmit-)	RD- (Receive-)
	3	RD+ (Receive+)	TD+ (Transmit+)
	4	n.c.	n.c.
	5	n.c.	n.c.
	6	RD- (Receive-)	TD- (Transmit-)
	7	n.c.	n.c.
	8	n.c.	n.c.

6.3.4 RJ45 connection cable

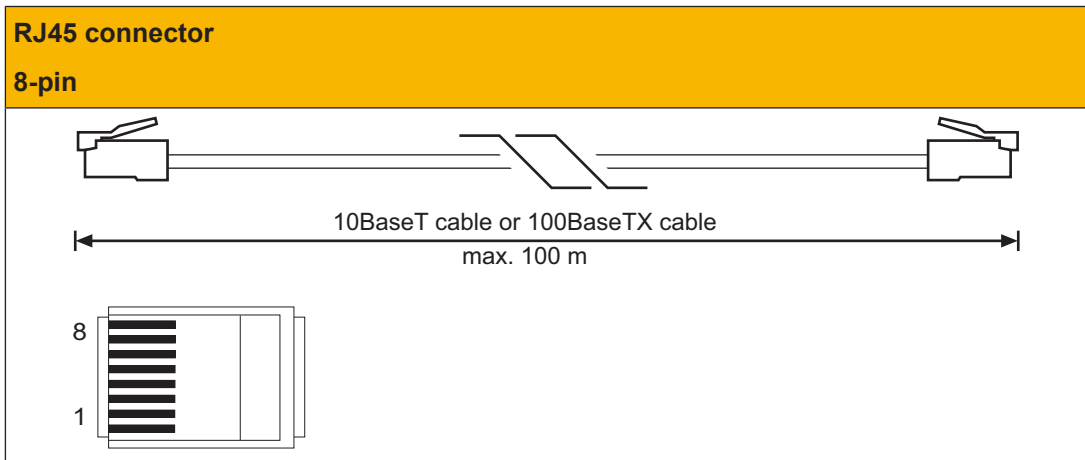

NOTICE

With the plug-in connection please note that the data cable and connector have a limited mechanical load capacity. Appropriate design measures should be used to ensure that the plug-in connection is insensitive to increased mechanical stress (e.g. through shock, vibration). Such measures include fixed routing with strain relief, for example.

6.4 Use USB memory

Multiple projects can be stored on the USB memory that is plugged into the device. One of these can be activated and executed on the base unit.

Please note the following when using the USB memory:

- ▶ The USB memory must always be plugged in during operation.
- ▶ In order to copy projects, for example, the USB memory can be removed and plugged into the PC or into another base unit PNOZ m B1.
- ▶ Only Pilz USB memories may be used!
- ▶ Due to mechanical requirements, the USB memory is plugged firmly into the device and so may be difficult to remove.
If this is the case, use an appropriate tool, such as a screwdriver, to carefully extract the USB memory (see illustration).
- ▶ To use the USB memory, insert the USB memory into the slot, applying light pressure. Make sure that the USB memory is inserted right up to the plastic handle (see illustration).

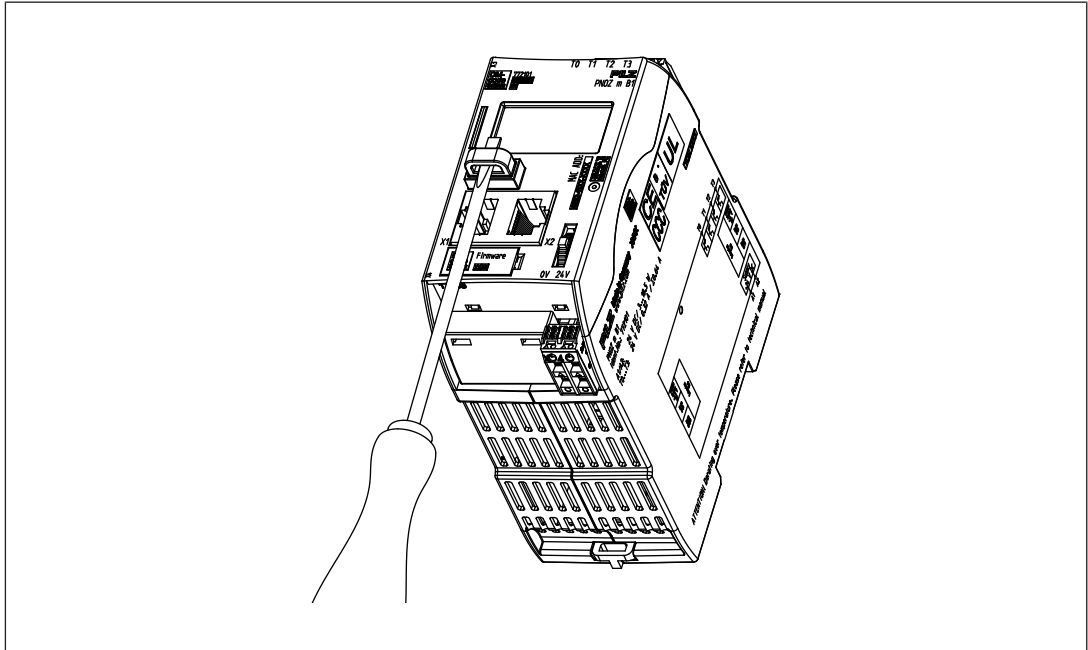

6.5 Load project from PNOZmulti Configurator

Projects can be transferred from the PNOZmulti Configurator to the USB memory. Several projects may be stored on the USB memory, A project can be activated directly. This can be performed in the Project Manager of the PNOZmulti Configurator (see online help for the PNOZmulti Configurator).

Procedure:

- ▶ Connect the computer containing the PNOZmulti Configurator to the base unit PNOZ m B1 via the Ethernet interface.
- ▶ Make sure that the USB memory is plugged into the base unit PNOZ m B1.
- ▶ Switch on the supply voltage.

- ▶ Transfer the required project to the USB memory and activate it on the base unit via the Project Manager on the PNOZmulti Configurator, as described in the online help for the PNOZmulti Configurator.
- ▶ As the project is loaded, the base unit must be stopped and then restarted.
- ▶ Once the project has been loaded successfully and the device has been restarted, the status of the supply voltage is shown on the display. The "RUN" LED is lit.

6.6 Activate project via the display on the base unit

A project that is stored on the USB memory can be activated in the base unit via settings on the display.

Procedure:

- ▶ Make sure that the USB memory containing the current project is plugged into the base unit PNOZ m B1.
- ▶ Switch on the supply voltage.
- ▶ Stop the device via the multifunction switch on the display via the menu setting **System mode** -> **Stop system** (for details of how to navigate the display see the section entitled [Display settings \[📖 23\]](#))
- ▶ In the **Project** menu, navigate to the folder containing the required project and select the project file with the extension **.mpnoz2**.
- ▶ Load the project by pressing the multifunction switch and restart via the menu setting **System mode** -> **Restart system**.

6.7 Display settings

Various settings can be made and information displayed via the menu on the device's display.

6.7.1 Operate menu

The menu settings are made on the device's display via a multifunction switch. You can switch between the menu levels by pressing or turning the multifunction switch.

Press multifunction switch



- ▶ Confirm selection/setting
- ▶ Switch to sub-menu
- ▶ Exit menu: \..

Move multifunction switch up or down



▶ Select menu







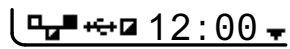

6.7.2 Displays and settings

The LC display has five lines. Information is shown on the display and settings can be made.



The field at the top right of the display shows information about the connection and instructions for the menu settings:



Legend:

-  Network connection/traffic
-  USB memory inserted
- 12:00** System time
-  Press the multifunction switch to go back to the higher level menu
-  Press the multifunction switch to access the sub-menu
-  Hold the multifunction switch down for 4 s to confirm the selection or perform the action
-  Press the multifunction switch to obtain information
-  Press the multifunction switch to call up the system message
-  Press the multifunction switch to call up the user message

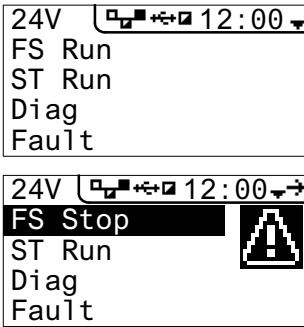
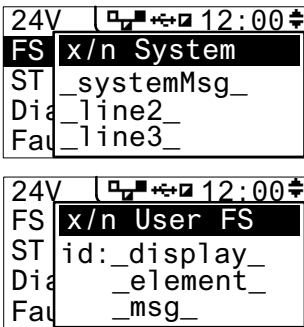
6.7.2.1 Status indicators

Display	Display	Description
<p>Permanent display</p>		<p>LED display</p> <ul style="list-style-type: none"> ▶ A warning symbol shows that a message is present, which can be called up
<p>System / User... System or display messages</p>		<p> System message is present</p> <p>or</p> <p> User message is present (user-specific messages that are created in the PNOZmulti Configurator)</p>

6.7.2.2 Project menu

In the **Project** menu you can display information about the project that is activated on the device. You can also activate a different project from the USB memory on the device. See also [Activate project via the display on the base unit](#) [📖 23] and reset the project on the device.

Display	Display	Description
Info:		Information is displayed about the project activated on the device
Name Project name		Name of project
Date / Time Creation data and time		Date and time that the project was created
Check sums FS Overall check sum and check sums of main program		Display of check sums: <ul style="list-style-type: none"> ▶ Overall project check sum ▶ Check sum safe of main program ▶ Check sum safe of main program without level 3
Check sums DP pos x Check sums of module program		Display of check sums of module program <ul style="list-style-type: none"> ▶ Check sum safe ▶ Check sum safe without level 3
History: Project history		Project information is displayed for one of the last 16 projects activated

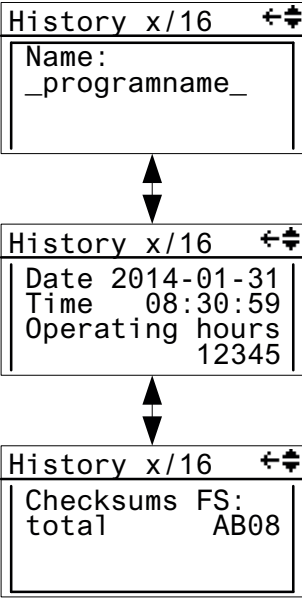
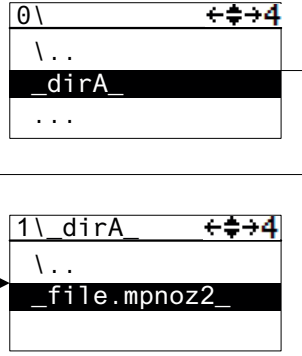
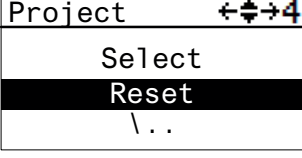
Display	Display	Description
<p>Name Date / Time Check sum FS Check sum DP pos x ...</p>		<p>Display of project information for a selected project</p>
<p>Select: Activate project</p>		<p>Select project contained in the USB memory and activate it on the base unit</p> <ul style="list-style-type: none"> ▶ Prerequisite: Device must be stopped ▶ Hold down multifunction switch for 4 s in order to activate the project
<p>Reset: Reset or update project.</p>		<p>After a reset, the active project is reloaded from the USB memory</p> <ul style="list-style-type: none"> ▶ Prerequisite: Device must be stopped ▶ Hold down multifunction switch for 4 s in order to reset

6.7.2.3 Device Info menu

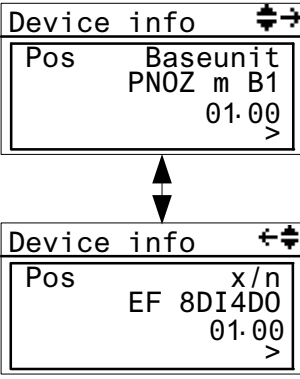
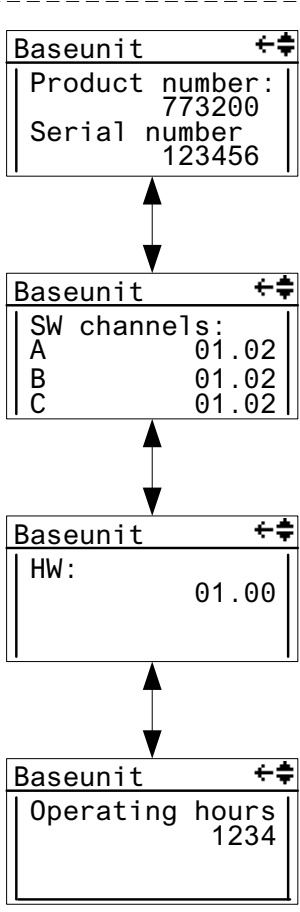
Display	Example	Description
<p>Device Info</p>		<p>Information on the base unit and expansion modules. Overview:</p> <ul style="list-style-type: none"> ▶ Position/slot ▶ Device type ▶ Firmware version
<p>Device information for module</p>		<p>Show device information for a selected module:</p> <ul style="list-style-type: none"> ▶ Order number ▶ Serial number ▶ Software versions ▶ Hardware version ▶ Operating hours

6.7.2.4 Error Stack menu

Display	Example	Description
<p>Error stack</p>		<p>Display of entries in the error stack (see also section entitled Show error stack on the display [34])</p> <p>To read the error stack entries please refer to the document <i>PNOZmulti Error Messages</i></p>

6.7.2.5 Operating Info menu

Display	Example	Description
<p>Operating Info</p>		<p>Display of specific operating parameters for the base unit and expansion modules.</p> <p>e.g.: cycle time, operating temperature, frequencies</p>

6.7.2.6 Connections menu

In the **Connections** menu the connections to the PNOZmulti can be displayed.

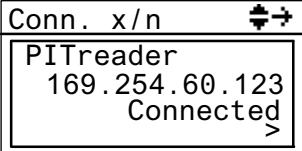
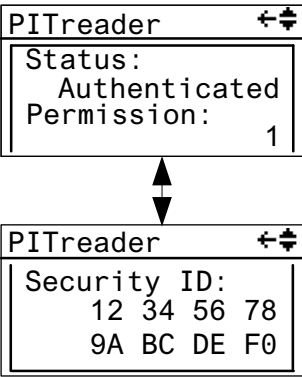
Display	Example	Description
Conn. x/n		<p>Information on the connected device:</p> <ul style="list-style-type: none"> ▶ Device ▶ IP address ▶ Connection status: <ul style="list-style-type: none"> – Connected: Connected – Connecting: Connecting – Failed: Connection has failed – Error: Error in the connection
PITreader		<p>Status information on PITreader:</p> <ul style="list-style-type: none"> ▶ Status: <ul style="list-style-type: none"> – Authenticated: PITreader detected the transponder key. Permission exists – No key: There is no transponder key inserted in PITreader – No permission: The transponder key has no permission (permission = 0) – Auth. failed: Authentication has failed. The data from PITreader are invalid – Not ready: The connection to PITreader is interrupted. ▶ Permission: Permission 1... 64 of the transponder key <p>Security ID: Safety identifier of the transponder key</p>

6.7.2.7 Ethernet menu

The Ethernet configuration can be displayed and changed in the **Ethernet** menu.

Display	Example	Description
Information		Display of the current Ethernet configuration
Change		Change Ethernet configuration...
Edit IP Change IP address		<ul style="list-style-type: none"> ▶ IP address ▶ Subnet mask ▶ Gateway Adjust -> Hold down multifunction switch for 2 s in order to access change mode
Edit ports Change IP address		Adjust PG port and scan port -> Hold down multifunction switch for 2 s in order to access change mode
Use DHCP Change IP address		Obtain IP address automatically from the network (prerequisite: Network has a DHCP Server utility) -> Hold down multifunction switch for 2 s in order to perform the action
Use program Change IP address		Load Ethernet settings from the active PNOZmulti project -> Hold down multifunction switch for 2 s in order to perform the action

Display	Example	Description
Use default Change IP address	<p>Ethernet ←↔→4 Use program Use default \..</p>	Load default settings IP address: 169.254.60.1 Subnet mask: 255.255.0.0 Gateway: 0.0.0.0 -> Hold down multifunction switch for 2 s in order to perform the action

6.7.2.8 Time menu

Display	Example	Description
Time Show date and time	<p>Time ←↔→4 Date 2014-01-31 Time 23:59:00</p>	Show system's date and time
Set time Set date and time	<p>The diagram shows a sequence of three screens. The first is the 'Time' menu (Date 2014-01-31, Time 23:59:00). A vertical double-headed arrow indicates a transition to the second screen, 'Time set' (Date 2014-01-31, Time 23:59:00). A horizontal arrow points from the 'Set time' option in the 'Time' menu to the 'Time set' screen.</p>	Change date and time -> Hold down multifunction switch for 2 s in order to access change mode

6.7.2.9 System mode menu

Display	Example	Description
Stop system Restart system	<p>System mode ←↔→4 \.. STOP system Restart system</p>	Stop system Restart system -> Hold down multifunction switch for 4 s in order to perform the actions

6.8 Function test during commissioning



CAUTION!

It is essential to check that the safety devices operate correctly

- After exchanging the USB memory
- After activating a project
- When the project was reset and reloaded from the USB memory following a restart (**Reset Project** menu).



7 Operation

When the supply voltage is switched on, the PNOZmulti 2 system loads the active project from the USB memory.

































7.1 LED indicators







The control system PNOZmulti is ready for operation when the **24 V**, **FS Run** and **ST Run** LEDs on the base unit are lit continuously.

Legend

-  LED on
-  LED flashes
-  LED off

The LEDs on the base unit change their label depending on the operating status

LEDs												Description	
24 V	FS			ST			Diag			Fault			
	FS Initialize	FS Run	FS Stop	ST Initialize	ST Run	ST Stop	Program Reset	Identify	Diag	IFAULT	OFAULT		Fault
													Supply voltage is present
													Reset project: the active project was deleted by the base unit.
													The base unit is identified via the PNOZmulti Configurator
													FS program is started
													ST program is started
													FS program is executed
													ST program is executed
													FS program in STOP condition
													ST program in STOP condition
													Error in FS program
													Error in ST program
													System error in FS program
													System error in ST program

LEDs												Description	
24 V	FS			ST			Diag			Fault			
	FS Initialize	FS Run	FS Stop	ST Initialize	ST Run	ST Stop	Program Reset	Identify	Diag	IFAULT	OFAULT		Fault
													Recoverable error by user in FS mode
													Recoverable error by user in ST mode

7.2 Show error stack on the display

The error stack can be read from the PNOZmulti Configurator or shown on the LC display. The error stack can store up to 64 status and error messages.

The following information is shown on the LC display:

- ▶ Sequential number of an error stack entry. A new error stack entry is stored in first place.
- ▶ Error class (EC)
- ▶ Error number (EN)
- ▶ Error parameter (EP)

Procedure for showing the error stack on the display, see section entitled Error Stack menu.

To evaluate the entries on the display please read the document ***PNOZmulti Error Messages***.

8 Technical details

General	
Certifications	CE, EAC (Eurasian), KOSHA, TÜV, cULus Listed
Application range	Failsafe
Electrical data	
Supply voltage	
for	Supply to the system
Voltage	24 V
Kind	DC
Voltage tolerance	-20 %/+25 %
Output of external power supply (DC)	18,5 W
Output of external power supply (DC) at no load	3 W
Max. power dissipation of module	4,5 W
Status indicator	Display, LED
Test pulse outputs	
Number of test pulse outputs	4
Voltage	24 V
Current	0,32 A
Max. duration of off time during self test	4 ms
Short circuit-proof	yes
Potential isolation	No
Ethernet interface	
Number	2
IP address (automatically off)	169.254.60.1
Connection type	RJ45
Transmission rate	10 MBit/s, 100 MBit/s
Times	
Simultaneity in the two-hand circuit	0,5 s
Processing time	30 ms
Environmental data	
Ambient temperature	
In accordance with the standard	EN 60068-2-14
Temperature range	0 - 60 °C
Forced convection in control cabinet off	55 °C
Storage temperature	
In accordance with the standard	EN 60068-2-1/-2
Temperature range	-25 - 70 °C
Climatic suitability	
In accordance with the standard	EN 60068-2-30, EN 60068-2-78
Humidity	93 % r. h. at 40 °C
Condensation during operation	Not permitted
Max. operating height above sea level	2000 m
EMC	EN 61131-2

Environmental data

Vibration

In accordance with the standard	EN 60068-2-6
Frequency	5 - 150 Hz
Acceleration	1g

Shock stress

In accordance with the standard	EN 60068-2-27
Duration	11 ms

Airgap creepage

In accordance with the standard	EN 61131-2
Overvoltage category	II
Pollution degree	2

Protection type

In accordance with the standard	EN 60529
Housing	IP20
Terminals	IP20
Mounting area (e.g. control cabinet)	IP54

Mechanical data

Mounting position	horizontally on mounting rail
-------------------	--------------------------------------

DIN rail

Top hat rail	35 x 7,5 EN 50022
Recess width	27 mm

Max. cable length

Sum of individual cable lengths at the test pulse output	2 km
--	-------------

Material

Bottom	PC
Front	PC
Top	PC

Connection type	Cage clamp terminal, screw terminal
-----------------	--

Mounting type	plug-in
---------------	----------------

Conductor cross section with screw terminals

1 core flexible	0,25 - 2,5 mm², 24 - 12 AWG
2 core with the same cross section, flexible without crimp connectors or with TWIN crimp connectors	0,2 - 1,5 mm², 24 - 16 AWG

Torque setting with screw terminals	0,5 Nm
-------------------------------------	---------------

Conductor cross section with spring-loaded terminals:

Flexible with/without crimp connector	0,2 - 2,5 mm², 24 - 12 AWG
---------------------------------------	--

Spring-loaded terminals: Terminal points per connection	2
---	----------

Stripping length with spring-loaded terminals	9 mm
---	-------------

Dimensions

Height	101,4 mm
Width	45 mm
Depth	120,2 mm

Weight	209 g
--------	--------------

Where standards are undated, the 2018-07 latest editions shall apply.

8.1 Safety characteristic data



NOTICE

You must comply with the safety characteristic data in order to achieve the required safety level for your plant/machine.

Operating mode	EN ISO 13849-1: 2015 PL	EN ISO 13849-1: 2015 Category	EN 62061 SIL CL	EN 62061 PFH _D [1/h]	IEC 61511 SIL	IEC 61511 PFD	EN ISO 13849-1: 2015 T _M [year]
2-channel	PL e	Cat. 4	SIL CL 3	4,19E-10	SIL 3	3,65E-05	20

Explanatory notes for the safety-related characteristic data:

- ▶ The SIL CL value in accordance with EN 62061 corresponds to the SIL value in accordance with EN 61508.
- ▶ T_M is the maximum mission time in accordance with EN ISO 13849-1. The value also applies as the retest interval in accordance with EN 61508-6 and IEC 61511 and as the proof test interval and mission time in accordance with EN 62061.

All the units used within a safety function must be considered when calculating the safety characteristic data.



INFORMATION

A safety function's SIL/PL values are **not** identical to the SIL/PL values of the units that are used and may be different. We recommend that you use the PAScal software tool to calculate the safety function's SIL/PL values.

9 Order reference

9.1 Product

Product type	Features	Order No.
PNOZ m B1	Base unit	772 101

9.2 Accessories

Connector

Product type	Features	Order no.
PNOZ mm0.xp terminator left	Terminator, black/yellow, x1	779 261
RJ45 Connector	8-pin RJ45 male connector, straight, Cat 6a	380 401

Connection terminals

Product type	Features	Order No.
Set4 Spring Terminals	1 set of spring-loaded terminals	751 016
Set4 Screw Terminals	1 set of screw terminals	750 016

Jumper

Product type	Features	Order No.
USB Memory 512MB	Pilz USB memory, 512 MB	779 213

► Support

Technical support is available from Pilz round the clock.

Americas

Brazil

+55 11 97569-2804

Canada

+1 888-315-PILZ (315-7459)

Mexico

+52 55 5572 1300

USA (toll-free)

+1 877-PILZUSA (745-9872)

Asia

China

+86 21 60880878-216

Japan

+81 45 471-2281

South Korea

+82 31 450 0680

Australia

+61 3 95600621

Europe

Austria

+43 1 7986263-0

Belgium, Luxembourg

+32 9 3217575

France

+33 3 88104000

Germany

+49 711 3409-444

Ireland

+353 21 4804983

Italy, Malta

+39 0362 1826711

Scandinavia

+45 74436332

Spain

+34 938497433

Switzerland

+41 62 88979-30

The Netherlands

+31 347 320477

Turkey

+90 216 5775552

United Kingdom

+44 1536 462203

You can reach our international hotline on:

+49 711 3409-444

support@pilz.com

Pilz develops environmentally-friendly products using ecological materials and energy-saving technologies. Offices and production facilities are ecologically designed, environmentally-aware and energy-saving. So Pilz offers sustainability, plus the security of using energy-efficient products and environmentally-friendly solutions.

Energy saving by Pilz



Pilz GmbH & Co. KG
Felix-Wankel-Straße 2
73760 Ostfildern, Germany
Tel.: +49 711 3409-0
Fax: +49 711 3409-133
info@pilz.com
www.pilz.com

PILZ
THE SPIRIT OF SAFETY

CMSE®, IndurANET p®, PAS4000®, PASscal®, PASconfig®, Pilz®, PIT®, PLID®, PMCPirotego®, PMCiendo®, PMD®, PMi®, PNOZ®, PNOZs®, PSEN®, PSENi®, PSS®, PViS®, SafetyBUS SafetyEYE®, SafetyNET p®, THE SPIRIT OF SAFETY® are registered and protected trademarks of Pilz GmbH & Co. KG in some countries. We would point out that product features mentioned in the details stated in this document, depending on the status at the time of publication and the scope of the equipment. We accept no responsibility for the validity, accuracy and entirety of the text and graphics presented in this information. Please contact our Technical Support if you have any questions.