

Laresar

CORDLESS VACUUM CLEANER

USER MANUAL



Model: Elite 3



CONTENTS

1	IMPORTANT SAFETY WARNING	01
	1.1 Precautions When Using	01
	1.2 Notes on the Battery Pack	01
	1.3 Notes on Charging	02
	1.4 Storage and Maintenance Precautions	02
2	PACKAGE CONTENT	03
3	OVERVIEW & ACCESSORIES	03
	3.1 Overview	04
	3.2 Digital Display Screen	05
	3.3 Accessories	05
4	ASSEMBLING & WALL MOUNTING	06
	4.1 Product Assembling	06
	4.2 Wall-Mount Plate	08
5	HOW TO USE	08
	5.1 Start to Work	08
	5.2 Select Cleaning Mode	09
6	CHARGING METHODS	09
	6.1 Charging Methods	09
	6.2 Battery Indicator	10
	6.3 Abnormal Indicator	10
7	MAINTENANCE	11
	7.1 Main Body Cleaning	11
	7.2 Dust Cup Cleaning	11
	7.3 Filter Cleaning	12
	7.4 Brush Roller Cleaning	13
8	SPECIFICATION	14
9	TROUBLESHOOTING	14
10	WARRANTY	15



1. IMPORTANT SAFETY WARNING

 **ATTENTION: Before using this machine, please read all instructions in the manual and cautionary markings on the machine carefully.**

1.1 Precautions When Using



- ① This Laesar machine is not intended for use by persons (including children) with reduced physical, sensory or reasoning capabilities, or lack of experience and knowledge, unless they have been given supervision or instruction concerning use of the machine by a person responsible for their safety.
- ② Use only as described in this Laesar Operating Manual. If the machine is not working as it should, if it has received a sharp blow, if it has been dropped, damaged, left outdoors, or dropped into water, do not use and contact the Laesar Support Team.
- ③ Suitable for dry locations **ONLY**. Do not install, charge or use this machine outdoors, in a bathroom or within 10 feet (3 meters) of a pool. Do not use on wet surfaces and do not expose to moisture, rain or snow.
- ④ When using this machine, please keep hair, loose clothing, fingers, and all parts of the body away from openings and moving parts. Do not point the hose, aluminium alloy tube or other accessories at your eyes or ears or put them in your mouth.
- ⑤ Do not use to pick up hard objects, such as glass slag, needles, nails, etc.
- ⑥ Do not touch the charger with wet hands to avoid electric shock. 
- ⑦ Use only Laesar recommended accessories and replacement parts.
- ⑧ Do not use without the dust cup and filter(s) in place.
- ⑨ When removing or replacing a motorized brush bar, be careful not to pull the power button until the cleaner head has been reassembled.
- ⑩ Do not water or spill liquid onto the vacuum cleaner. If that happens, it will increase the risk of electric shock. 
- ⑪ Use extra care when cleaning on stairs.
- ⑫ Please do not use the vacuum cleaner to suck the detergent, kerosene, soot, wet dust, water, sewage, matches and other items.
- ⑬ Please do not use a vacuum cleaner to suck up small particles such as cement, gypsum powder, wall powder, or large objects such as toy paper balls, otherwise it will cause the vacuum cleaner to block and the motor to burn out.

1.2 Notes on the Battery Pack

- ① Do not throw the battery pack away, and it should be safely disposed in accordance with local regulations.
- ② Do not use a battery pack or machine that is damaged or modified. Damaged or modified batteries may exhibit unpredictable behavior resulting in fire, explosion or risk of injury. 
- ③ Do not incinerate batteries or expose to high temperatures, as they may explode. 
- ④ The battery is a sealed unit and under normal circumstances poses no safety concerns. In the unlikely event that liquid leaks from the battery, do not touch the liquid as it may cause irritation or burns, and observe the following precautions: 

- Skin contact – can cause irritation. Wash with soap and water.
 - Inhalation – can cause respiratory irritation. Expose to fresh air and seek medical advice.
 - Eye contact – can cause irritation. Immediately flush eyes thoroughly with water for at least 15 minutes. Seek medical attention.
 - Disposal – wear gloves to handle the battery and dispose of immediately, following local ordinances or regulations.
- ⑤ When the battery pack is not in use, keep it away from paper clips, coins, keys, nails, screws or other small metal objects that could make a connection from one terminal to another.

1.3 Notes on Charging

- ① Before use, check the charger cord for signs of damage or ageing. A damaged or entangled charger cord increases the risk of fire and electric shock. 
- ② Never modify the charger in any way.
- ③ The charger has been designed for a specific voltage. Always check that the mains voltage is the same as that stated on the rating plate.
- ④ Unplug the charger when not in use for extended periods.
- ⑤ When your vacuum cleaner is fully charged, needs to be cleaned or repaired, please unplug the charger in time and do not pull the power cord directly.
- ⑥ Do not pull the cord to disconnect from a socket, grasp the plug and pull to disconnect.
- ⑦ Don't wrap the cord around the charger when storing.
- ⑧ Please fully recharge the battery, when first used or used after long time storage. If the product is not used for long time, please make sure the battery is recharged and used each three months at least.
- ⑨ If smoke or fire occurs during charging, unplug the charger immediately, and use a fire extinguisher to put out the fire. Do not use water to extinguish the fire, it will increase the risk of electric shock. 
- ⑩ Follow all charging instructions and do not charge the battery pack or the machine outside of the temperature range specified in the instructions. Charging improperly or at a temperature outside of the specified range may damage the battery and increase the risk of fire. To ensure maximum battery life, Laesar recommends the following: 
- When not in use the machine should be stored at room temperature. Recommended range: 64°F (18°C) to 82°F (28°C).
 - The ambient temperature range for operation and charging should be 50°F (8°C) to 86°F (35°C).

1.4 Storage and Maintenance Precautions

- ① Please store the product under cool and dry environment. Please avoid long-time sunshine on the product.
- ② The charger must be removed from the socket before removing the battery, cleaning or maintaining the appliance.
- ③ Please use dry cloth to clean the vacuum cleaner. Please do not use gas or liquid that can make the surface cracked or color faded.
- ④ Do not apply any fragrance or scented product to the filter(s) of this machine. The chemicals in such products are known to be flammable and can cause the machine to catch fire.
- ⑤ Do not carry out any maintenance other than that shown in this manual, or advised by the

Laesar Support Team.

- ⑥ Do not disassemble the machine as incorrect reassembly may result in an electric shock or fire. Contact the Laesar Support Team when a service or repair is required.

SAVE THESE INSTRUCTIONS



Do not use near open flames.



Do not store near heat sources.



Do not pick up water or liquids.



Do not pick up burning objects.



Do not put hands near the brush bar when the machine is in use.



Do not place on or near the cooker.

2. PACKAGE CONTENT

Please check and confirm the accessories and parts according to the following sheet before using.

Part Name	Quantity
Main Body	1
Adjustable Extension Tube	1
Motorized Brush Head	1
2 in 1 Roller Brush	1
Long Crevice Nozzle	1
2 in 1 Upholstery Brush	1
Hair Cleaning Tool	1
Filter Replacement	1

Sponge Replacement	1
Wall Mount Plate	1
Charger	1
Battery Pack	1
User Manual	1

3. OVERVIEW & ACCESSORIES

3.1 Overview

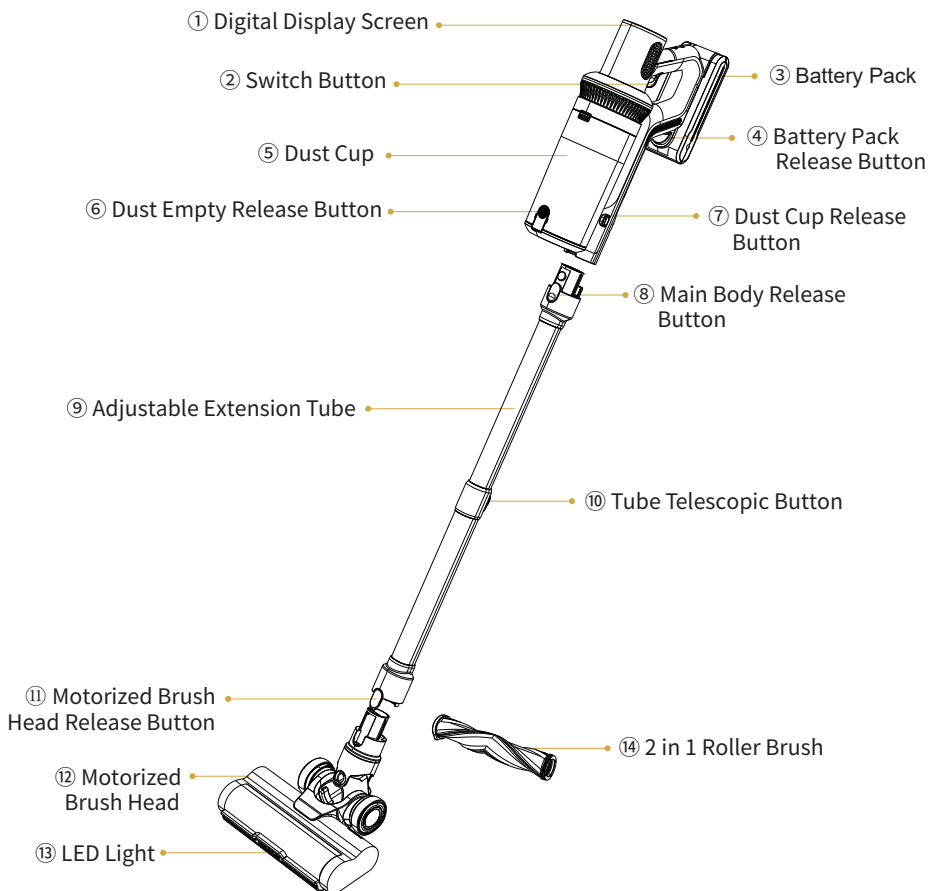

3.2 Digital Display Screen

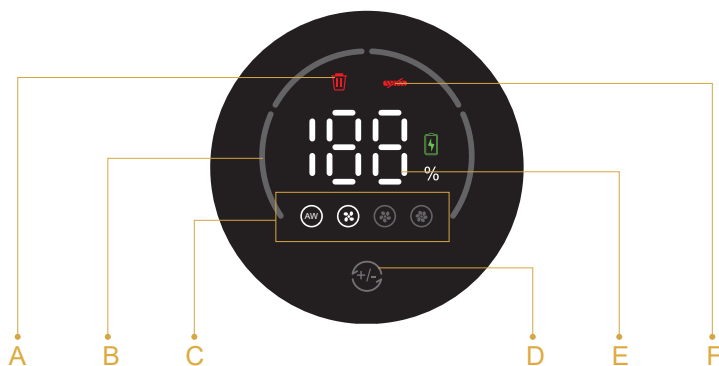

A.Full cup reminder

B.Suction power indicator loop

C.Suction mode indicator (Eco/Standard/Boost)

D.Suction adjust button

E.Remaining battery power

F.Floor brush blocked indicator

3.3 Accessories

① 2 in 1 Upholstery Brush

Brush retractable design can help you remove dust and hair from both upholstered furniture and hard surface furniture.

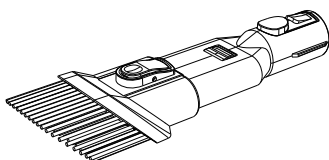

② Long Crevice Nozzle

Remove dust on hard to reach area like windows, bed feet, gaps between tables and chairs, etc.

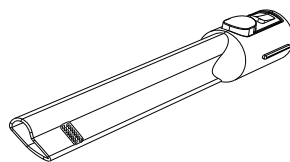

③ Hair Cleaning Tool

Remove hair, rubbish and micro dust on the brush shaft to keep the brush head clean.



④ Wall Mount Plate

Hold the vacuum on wall-mount plate for easy storage and battery charging.

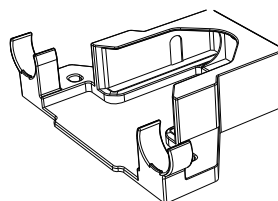

⑤ 2 in 1 Roller Brush

Remove dust, debris and hair from hard floors, carpets and velvet.

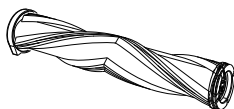

4. ASSEMBLING & WALL MOUNTING

4.1 Product Assembling

4.1.1 Install the Battery Pack

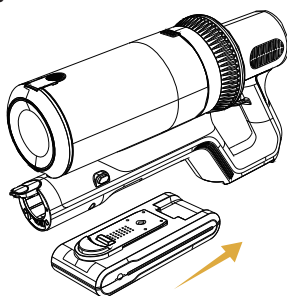

4.1.2 Install the Extension Tube

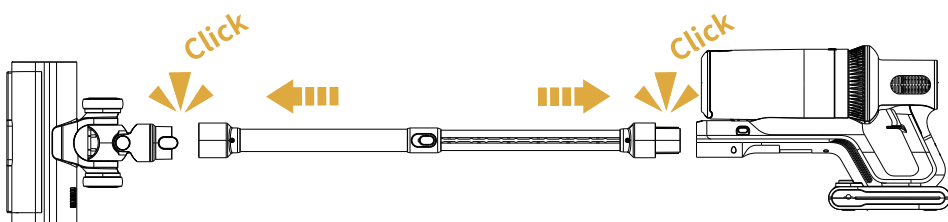

4.1.3 Install Desired Cleaning Accessory

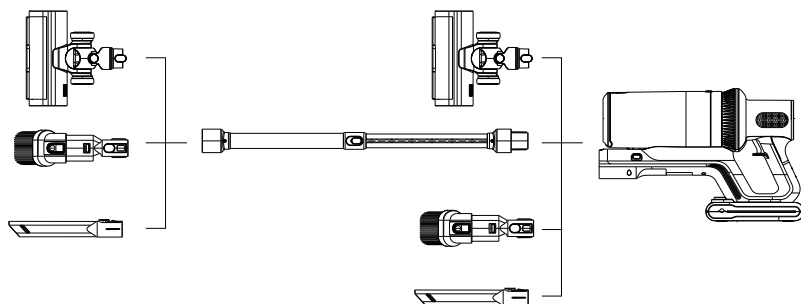

4.2 Wall-Mount Plate

The vacuum cleaner cannot stand on its own. Fix the wall-mount plate to the wall securely with the screws provided by Laesar.

WARNING

- Please make sure there is no gas, water or electrical cables and wires behind the mounting area.
- To avoid the dock dropping down, please make sure it must be installed firmly.

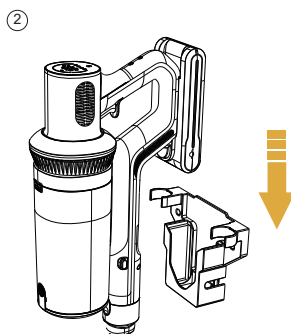
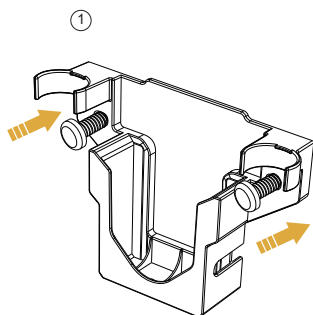

5. HOW TO USE



Before use, make sure that

- The battery is fully charged, and fixed in place.
- The dust cup and filters are cleaned, dried, and fixed in place.

5.1 Start to Work

Press the switch button, the appliance will start to work. Press the button again to shut down the appliance.

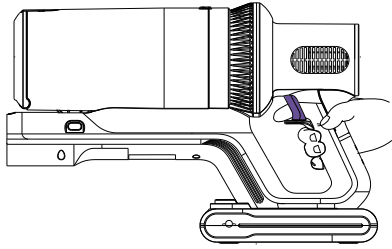

5.2 Select Cleaning Mode

- Boot into "Eco" Mode
- Touch the "+/-" Key Set to "Standard" Mode
- Touch the "+/-" Key Again Switch to "Boost" Mode

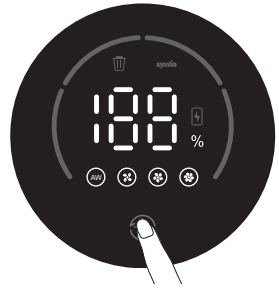

6. CHARGING METHODS

6.1 Charging Methods

- ① Remove the Battery Pack and Charge it Separately

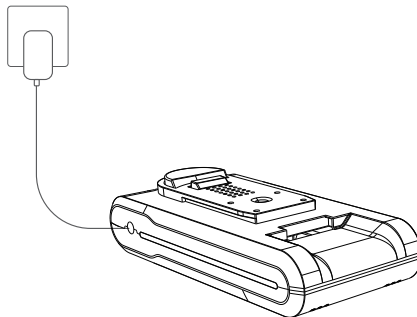

② Connect the Main Body to Charge

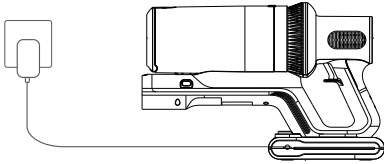

③ Hang on the Wall Mount to Charge

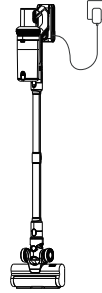

6.2 Battery Indicator

6.2.1 Charging Indicator

The battery indicator light will be flashing in blue when being charged and turn blue when the battery is fully charged.

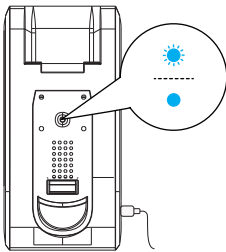

Blue light flashing (Charging)
Blue light (Fully Charged)

- The number represents the remaining power.
- When charging, the power indicator on the display changes with the battery power, and the battery icon continues to flash.
- When fully charged, the battery indicator on the display goes out, and the battery icon stops flashing and remains green.



6.2.2 Low Battery Level Indicator

- When the battery level is under 15%, the battery indicator on the screen will start to flash in red. The vacuum cleaner should be charged as soon as possible.
- When the battery power is less than 30%, the battery indicator on the screen flashes red for 30 seconds after the vacuum cleaner is turned off and then goes out. The vacuum cleaner should be charged as soon as possible.



6.3 Abnormal Indicator

- When the brush roller is blocked, the LED light on the electric floor brush goes out, and the red brush roller indicator blinks for 6 seconds and then goes out.
- When the host is blocked, the red cup full reminder flashes for 30 seconds and then goes out..

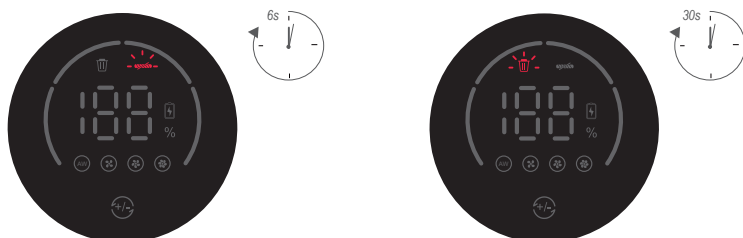

- When using an adapter not provided by Laresar, the battery indicator and battery icon will turn red, blinking for 60 seconds and then go out.

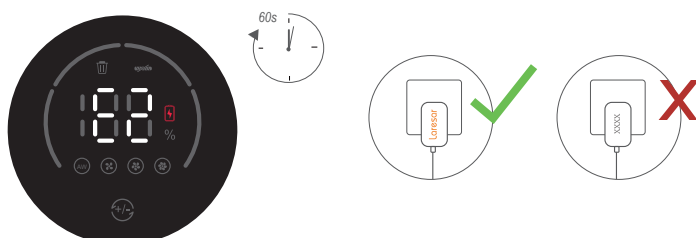

7. MAINTENANCE

Please clean it regularly to prolong the service life of the vacuum cleaner.

7.1 Main Body Cleaning

- Turn off the power before cleaning the body.
- Please use a neutral detergent, wipe the body with half-wet cloth.
- Please avoid sun exposure and store in a cool and dry place.

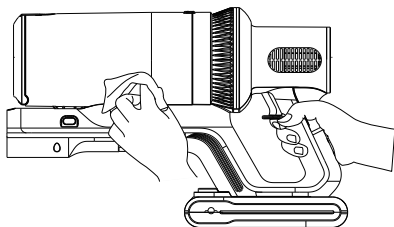

7.2 Dust Cup Cleaning

7.2.1 Empty the Dust Cup

- Press the dust cup release button to empty the dust.
- When using, if the garbage in the dust cup exceeds MAX Line, please empty it in time.

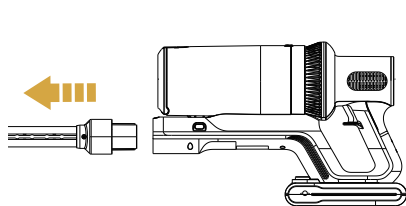

①

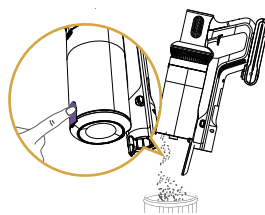

②

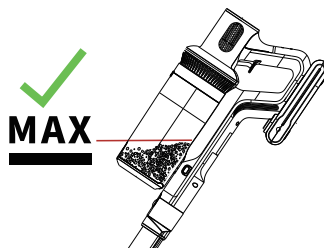

7.2.2 Clean the Dust Cup

- Press the dust cup release button to remove the dust cup, take out the sponge, HEPA filter and the stainless steel filter in turn.

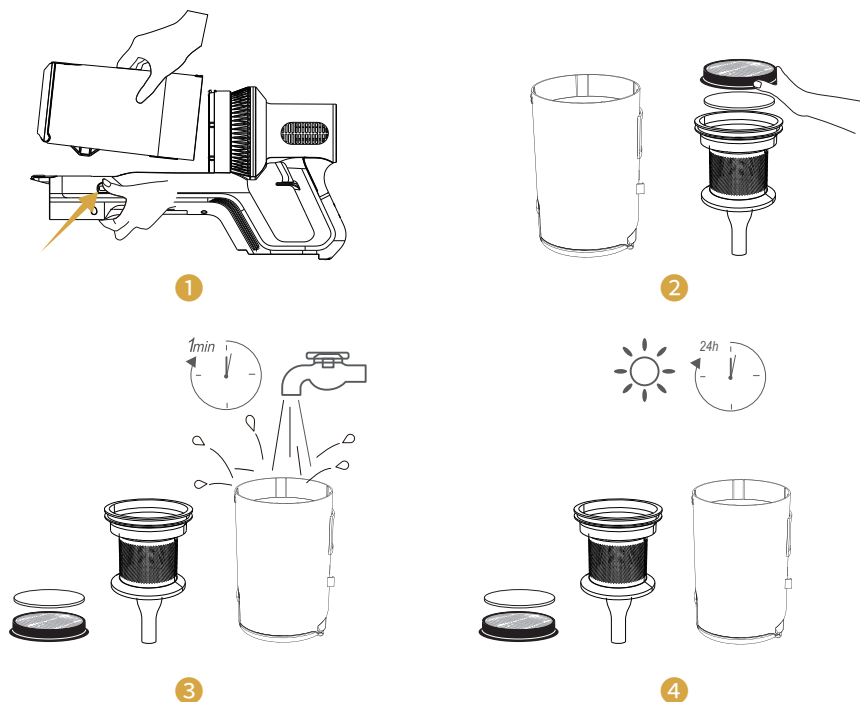

7.3 Filter Cleaning

⚠ Note: Wash the filters with cold water at least once every month.

- Filter sponge and HEPA filter can be rinsed with water to remove dust.
- Please ensure the filters are completely dry before reassembly.

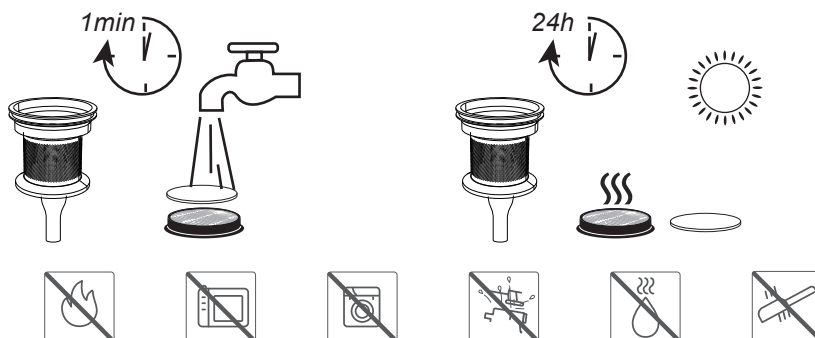

7.4 Brush Roller Cleaning

⚠ Note: After long periods of use, the bristle may be jammed by hair or similar build-up. It's recommended to clean the brush roller periodically to ensure efficient operation and maintain suction.

- Remove the brush roller, gently clean the motored brush window and suction mouth.

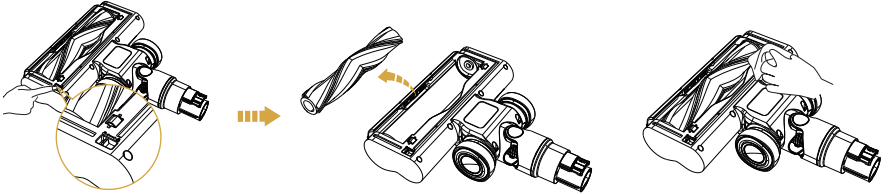

- Remove the debris wrapped around the roller with Laesar Hair Cleaning Tool, then flush with water.

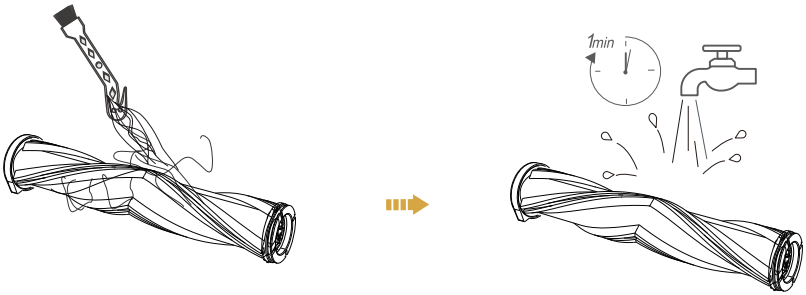

- Insert the brush roller into the motored brush window, push down the cover until it securely in place. (Please make sure the brush roller is completely dry before using.)

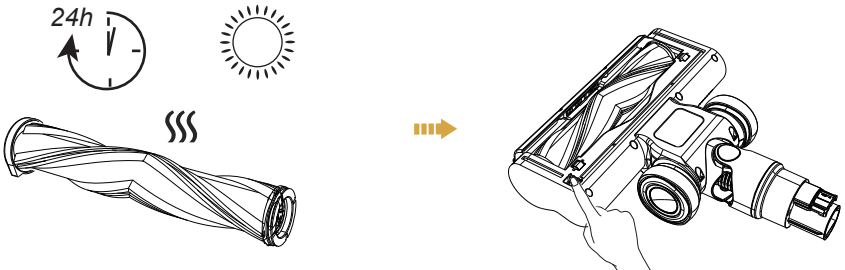

8. SPECIFICATION

Product	Cordless Vacuum Cleaner
Model	Elite 3
Rated Voltage	25.9V $\overline{\text{---}}$
Cleaning Modes	Eco/Standard/Boost

9. TROUBLESHOOTING

ISSUE	CAUSE	SOLUTION
The vacuum cleaner can not work	<ul style="list-style-type: none"> (1) Out of power (2) Battery Pack not installed in place (3) The Motorized Brush Head is blocked with hair and other debris (4) Auto protection for overheating Switch Button can not work (5) Switch Button can not work 	<ul style="list-style-type: none"> (1) Charge the vacuum cleaner (2) Battery Pack installed in place (3) Clean the Motorized Brush Head (4) Restart after cooling down (5) Contact Laresar Support for replacement
Weak suction	<ul style="list-style-type: none"> (1) Dust Cup is full of garbage (2) Dust baffle misaligned (3) Filter are clogged or not installed in place (4) Filter Sponge or HEPA Filter not dry (5) Extension Tube and Motorized Brush Head is blocked with hair or other debris (6) Low power 	<ul style="list-style-type: none"> (1) Empty the Dust Cup (2) Align the dust baffle to correct hole (3) Clean or change the Filter and reinstall correctly (4) Dry out Filter Sponge or HEPA Filter (5) Clean the Extension Tube and Motorized Brush Head (6) Charge the vacuum cleaner

<p>Charging indicator does not light up or flash abnormally</p>	<p>(1) Battery Pack is dead or broken (2) Charger is not correctly connected (3) Charger is wrong</p>	<p>(1) Change the Battery Pack (2) Make sure the Charger are fully plugged in socket and Battery Pack (3) Use the Charger provided by Laesar</p>
<p>Insufficient running time after charging</p>	<p>(1) Insufficient charging time (2) Battery aging (3) Motorized Brush Head or is blocked with hair or other debris (4) Charger is wrong</p>	<p>(1) Vacuum cleaner fully charged (2) Change the Battery (3) Clean the Motorized Brush Head (4) Use the Charger provided by Laesar</p>
<p>The Roller Brush stops rotating</p>	<p>(1) Brush Roller are blocked with hair, pebbles or other debris (2) Dust Cup is full of dust</p>	<p>(1) Clean the Brush Roller (2) Avoid picking up large rubbish, such as pebbles (3) Empty the Dust Cup Contact Laesar Support for replacement (4) Contact Laesar Support for replacement</p>

10. WARRANTY

The 2-Year Limited Warranty

- Your Laesar machine has a 2-year warranty against original defects in material and workmanship, when used for private household purposes in accordance with the Laesar Instruction Manual.
- This warranty provides, at no extra cost to you, all labor and parts necessary to ensure your machine is in proper operating condition during the warranty period.

WHAT IS COVERED?

According to the requirements outlined in this instruction manual, subject to the following conditions and exclusions.

Only applies to purchases made from authorized retailers of Laesar.

This warranty will only be valid if the machine is used in the country in which it was sold.

WHAT IS NOT COVERED?

Laesar shall not be liable for costs, damages or repairs incurred as a result of:

- Machines purchased from an unauthorized dealer.

- Careless operation or handling, misuse, abuse and/or lack of maintenance or use not in accordance with the Laresar Instruction Manual.
- The machines are used for commercial or rental purposes in addition to normal domestic use.
- Use of parts not in accordance with the Laresar Instruction Manual.
- Use of parts and accessories other than those produced or recommended by Laresar.
- External factors unrelated to product quality and use, like accidental water damage.
- Repairs or alterations carried out by unauthorized parties or agents.
- Normal wear and tear, including Dust Cup, Belt, Filter, HEPA, Brush Roller, and Power Cord (or where external damage or abuse is diagnosed), carpet or floor damage due to use not in accordance with manufacturer's instructions or failure to turn the brush roller off when necessary.
- Reduction in battery discharge time due to battery age or use.

HOW TO CLAIM?

Please keep your proof of purchase. To make a claim under our Limited Warranty, you need to provide your original purchase receipt with the purchase date and order number on it.

All work will be carried out by Laresar or its authorized agency.

Any replaced defective parts will become the property of Laresar.

Service under this warranty will not extend the period of this warranty.

If your machine is not functioning properly, or you still have any questions after reading this manual carefully, please feel free to contact us, we will try our best to provide you with a satisfactory solution.



**Email our Customer Service:
support@laresar.us**

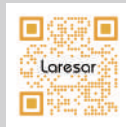

Laresar is here to help and we are glad to serve you.

Correct Disposal of This Product

This marking indicates that this product should not be disposed with other household wastes throughout the EU. To prevent possible harm to the environment or human health from uncontrolled waste disposal, recycle it responsibly to promote the sustainable reuse of material resources. To return your used device, please use the return and collection systems or contact the retailer where the product was purchased. They can take this product for environmental safe recycling.

FCC STATEMENT :

This equipment has been tested and found to comply with the limits for a Class B digital device, pursuant to part 15 of the FCC Rules. These limits are designed to provide reasonable protection against harmful interference in a residential installation. This equipment generates uses and can radiate radio frequency energy and, if not installed and used in accordance with the instructions, may cause harmful interference to radio communications. However, there is no guarantee that interference will not occur in a particular installation. If this equipment does cause harmful interference to radio or television reception, which can be determined by turning the equipment off and on, the user is encouraged to try to correct the interference by one or more of the following measures:

- Reorient or relocate the receiving antenna.
- Increase the separation between the equipment and receiver.
- Connect the equipment into an outlet on a circuit different from that to which the receiver is connected.
- Consult the dealer or an experienced radio/TV technician for help

Changes or modifications not expressly approved by the party responsible for compliance could void the user's authority to operate the equipment.

This device complies with Part 15 of the FCC Rules. Operation is subject to the following two conditions:

- (1) this device may not cause harmful interference, and
- (2) this device must accept any interference received, including interference that may cause undesired operation.

Declaration of Conformity

We (Manufacturer is responsible for this declaration)

Ekoo Electronic Co.,Ltd.
(Company name)

B09.block B.f2.bldg.b.runfeng Pioneer Park.no.973. minzhi Avenue. Minzhi St., Longhua,
Shenzhen, CN
(Company address)

declare under our sole responsibility that the product

Trade name: Laesar

Equipment: Vacuum Cleaner

Model No. : Elite 3

to which this declaration relates is in conformity with the essential requirement set out in the Council Directive on the Approximation of the laws of the Member States relating to LVD Directive(2014/35/EU) & EMC Directive(2014/30/EU) & RoHS(2011/65/EU) product is responsible to affix CE marking, the following standards were applied:

EN 60335-2-2:2010+A11:2012+A1:2013
EN 60335-1:2012+A11:2014+A13:2017+A1:2019+A14:2019+A2:2019
EN 62233:2008
EN 55014-1:2021
EN 55014-2:2021
EN IEC 61000-3-2:2019+A1:2021
EN 61000-3-3:2013+A2019
IEC62321-3-1:2013
IEC62321-4:2013
IEC62321-5:2013
IEC62321-6:2015
IEC62321-7-1:2015
IEC62321-7-2:2017
IEC62321-8:2017

Full Name: George.wang Position: Approbation Manager

Signature: George.wang Place/Date: Shenzhen,China/Doc.04-2021