

CHEFMAN®

TURBOFRY TOUCH DIGITAL AIR FRYER

This is your one-stop guide to using your product. From the below links, you can jump ahead to a specific document if desired.

QUICK LINKS

- [Quick Start Guide](#)
- [User Guide](#)
- [Recipe Book](#)

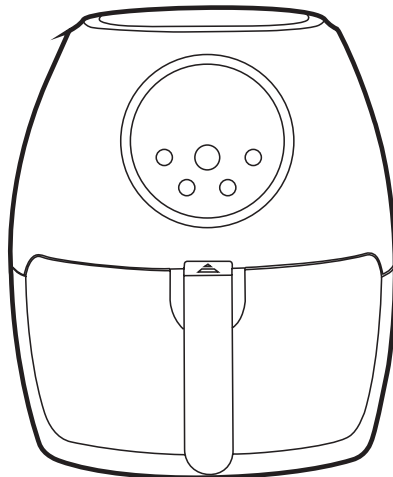

QUICK START GUIDE

BEFORE FIRST USE

1. Remove all packing materials and stickers from the inside and outside of the Air Fryer. Gently wipe down exterior with a damp cloth or paper towel. **WARNING:** Never immerse the Air Fryer or its plug in water or any other liquids.
2. Pull the basket handle to remove the basket from the Air Fryer. Use the tray handle, in the center of the tray, to remove the tray. Use a sponge and warm, soapy water to wash the inside and outside of the basket and tray. The basket and the tray are top-rack dishwasher safe. Do NOT use abrasive cleaning agents or scouring pads.
3. Dry thoroughly.
4. Read all instructions, including the user guide, and follow them carefully.

WHAT'S IN THE BOX

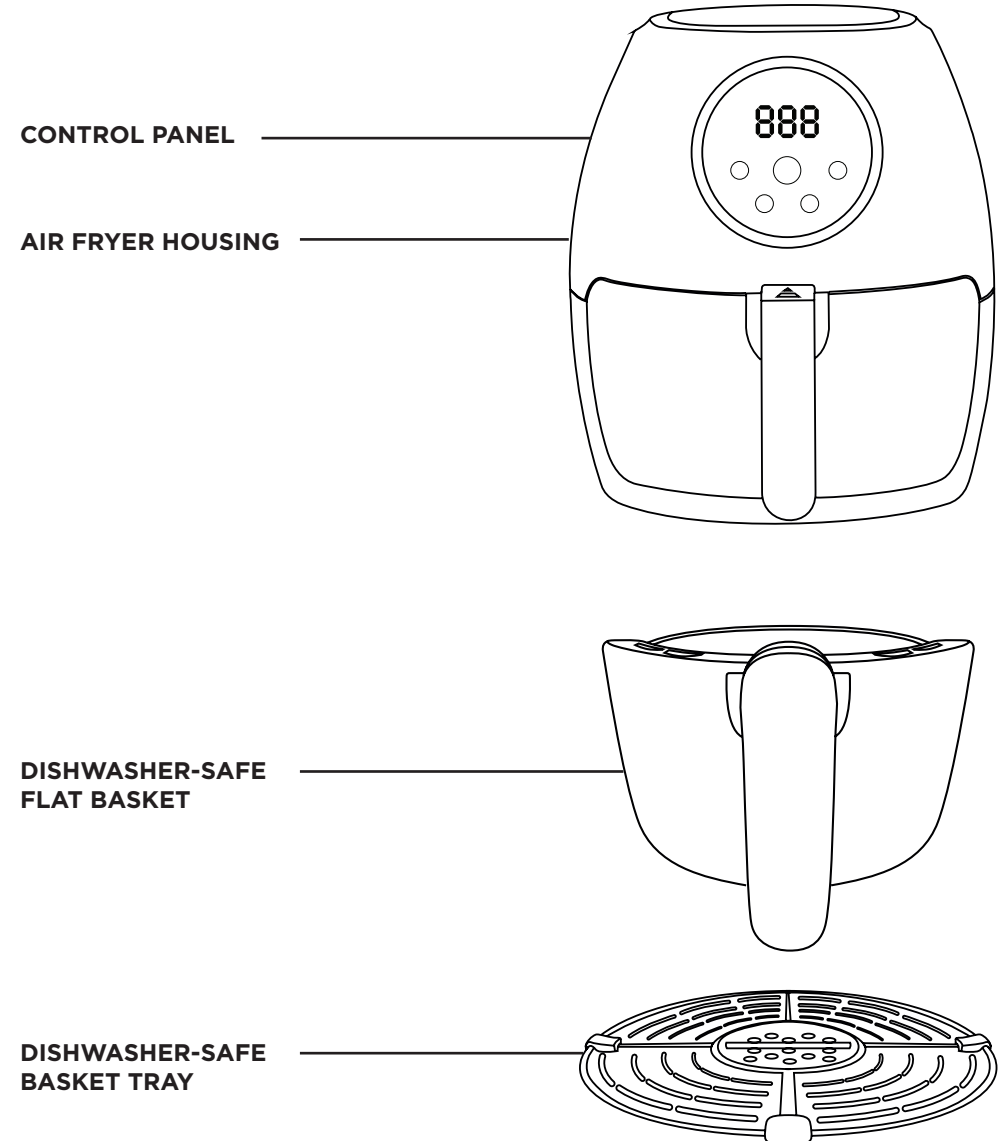

HOW TO USE

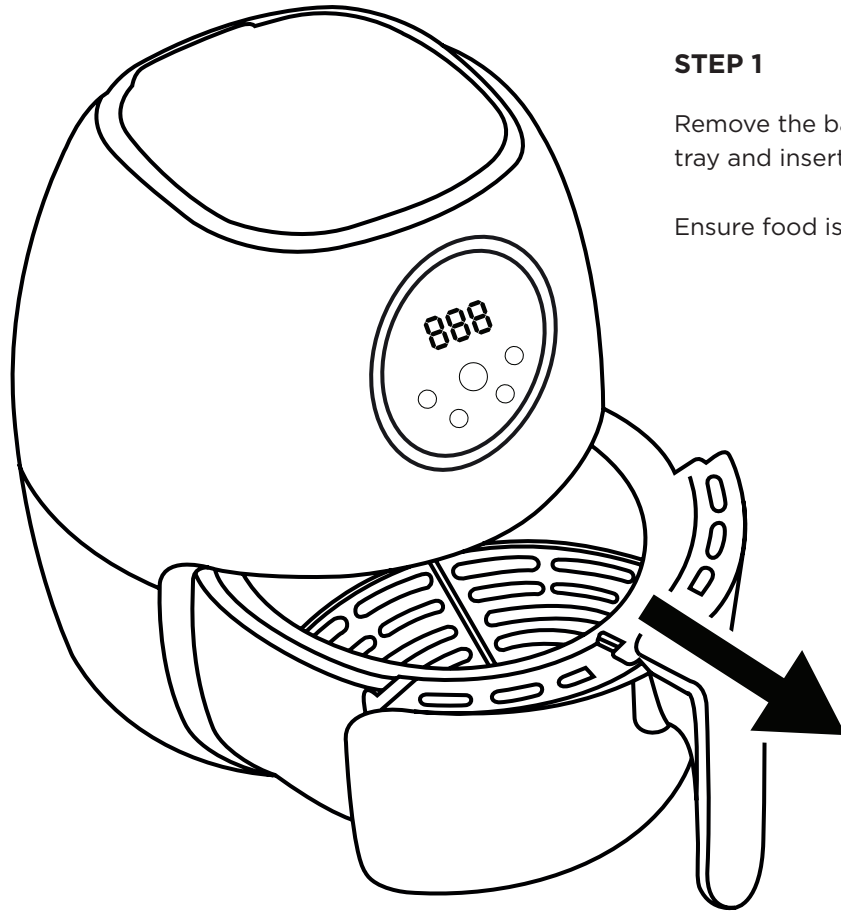

STEP 1

Remove the basket, place food on top of tray and insert basket back into Air Fryer.

Ensure food is never cooked without tray.

HOW TO USE

STEP 2

Select desired temperature.

Select desired time and press the Start button. If desired, shake basket halfway through cooking to redistribute food.

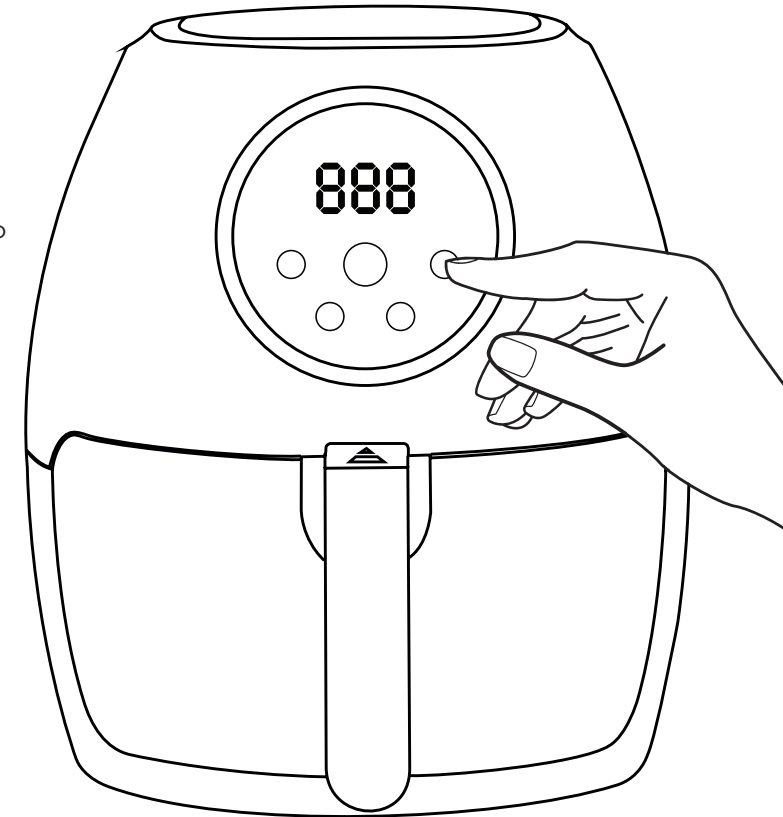

HOW TO USE

STEP 3

When timer expires, use tongs to remove food.

CAUTION: Food will be hot.

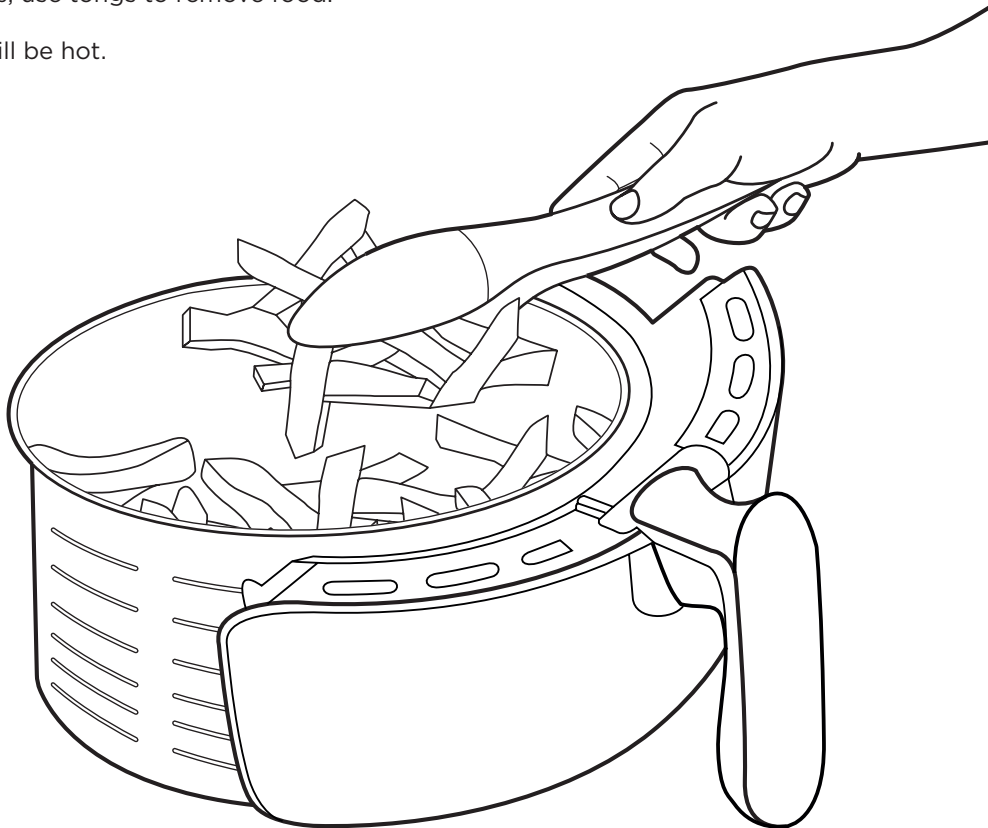

CLEANING AND MAINTENANCE

1. Ensure the Air Fryer is unplugged and cool before cleaning.
2. Once the Air Fryer and basket are cool, remove the basket from the Air Fryer (if it is not already removed). Use the tray handle to remove tray. Use a sponge and warm, soapy water to wash the inside and outside of the basket and tray.

WARNING: Do NOT use abrasive cleaning agents or scouring pads. The basket and tray are top-rack dishwasher safe.

3. Gently wipe down exterior with a damp cloth or paper towel.
4. Dry all parts thoroughly before storage.
5. Store the Air Fryer in a cool, dry place.

AIR FRYER TIPS

- Almost any food that is traditionally cooked in the oven can be air fried.
- Foods cook best and most evenly when they are of similar size and thickness.
- Smaller pieces of food require less cooking time than larger pieces.
- For best results in the shortest amount of time, air fry food in small batches. Avoid stacking or layering when possible.
- Most prepackaged foods do not need to be tossed in oil before air frying. Most already contain oil and other ingredients that enhance browning and crispiness.
- Toss foods you are preparing from scratch, such as French fries or other vegetables, with a small amount of oil to promote browning and crispiness.
- For best results, arrange food on the tray in a single layer.
- If layering foods, be sure to shake the basket halfway through (or flip food) to promote even cooking.
- Air fryers are great for reheating food, including pizza. To reheat your food, set the temperature to 300°F for up to 10 minutes. Use a thermometer to ensure reheated foods reach an internal temperature of 165°F.

USER GUIDE

COOKING FORWARD™

Thanks for purchasing a Chefman® appliance.

Love to cook or rarely enter the kitchen? We've got you covered. Creating innovative kitchen appliances and guides for all skill levels just so happens to be our expertise.

Saving time, reducing stress, and cooking more efficiently are just a few things to enjoy as you create restaurant-quality meals using our products. You'll embrace a new world of culinary possibilities and cook with confidence. We like to call this the cooking forward effect!

So go ahead, promote yourself from cook to head chef in your household. (You deserve it!)

From our kitchen to yours,
The Chefman® Team



READ ALL INSTRUCTIONS BEFORE USE

For your safety and continued enjoyment of this product, always read the instruction manual before using.

CONTENTS

- 10** Safety Instructions
- 13** Features
- 14** Operating Instructions
- 17** Tips
- 20** Troubleshooting
- 21** Cleaning and Maintenance
- 22** Terms and Conditions
- 23** Warranty Card

SAFETY INSTRUCTIONS

IMPORTANT SAFEGUARDS

WARNING: When using electrical appliances especially when children are present, basic safety precautions should always be followed to reduce the risk of fire, electric shock, and/or injury to persons, including the following:

1. This appliance should be used only by persons who are capable of understanding the user guide or are supervised by those who have adequate understanding of the appliance's features, use and operating instructions. Children must be supervised and should not be left alone with any appliance during operation.
2. Never use any accessories or parts from other manufacturers. Your warranty will become invalid if such accessories or parts have been used.
3. Place the Air Fryer on a stable, heat resistant surface. Make sure not to place it near or on any type of heat source, such as a gas or electric burner, stove or oven. Do not use near an open flame or flammable materials.
4. **Never operate the Air Fryer, or any appliance, on a gas or electric stovetop, even if the stovetop is off and completely cool.**
5. Appliances may emit heat or steam when in use; do not to block inlets or outlets.
6. Short power cords are attached to the Air Fryer to prevent entanglement and tripping hazards. Extension cords with corresponding voltage, electrical rating and grounding wires can be used. Care should be taken so that any exposed cord is not hanging down from a counter or table where it can be pulled on or tripped over by any child or adult.
7. Check that your home power supply corresponds with the Air Fryer's intended voltage.
8. Before using the Air Fryer, inspect the plug and cord line for cuts and/or abrasion marks. Do not use the Air Fryer if it is damaged in any way. Contact Chefman Customer Service for assistance.
9. Insert the plug by grasping it firmly and guiding it into your home's grounded electrical outlet. Disconnect by grasping the plug and removing it from your home's grounded electrical outlet. Never wrap the cord tightly around the appliance during use or storage; this may cause the wire to fray and break.
10. This product is not a deep fryer. It is NOT meant to be filled with oil. Never fill the basket or any parts of the Air Fryer with oil. If you choose to use oil, toss food with oil in a separate bowl and then transfer food to the Air Fryer Basket.

SAFETY INSTRUCTIONS

IMPORTANT SAFEGUARDS

11. Do not leave uncooked ingredients in the Air Fryer for more than a short period of time; raw meat, poultry, fish, fruits and vegetables can spoil.
12. Do not move the Air Fryer while it is full of food.
13. During initial use, you may notice some smoke and/or a slight odor. This is normal and should quickly dissipate. It should not reoccur after the appliance has been used a few more times.
14. Do not leave Air Fryer unattended during use.
15. Do not move Air Fryer during use.
16. The exterior of the Air Fryer is designed to be cool to the touch. Some areas do get HOT during use. Do not touch the heating elements. Do not place hands or other body parts near the air vents while Air Fryer is in use. Burns may result. Take caution when handling the hot Air Fryer Basket and Tray.
17. This Air Fryer needs space to allow heat to escape to prevent the risk of fire. Make sure the fryer has sufficient space around it. Do not cover the fryer, and make sure the air vents on the back are not cover or blocked.
18. Use protective gloves and/or tongs to remove hot food from the Air Fryer.
19. Unplug the Air Fryer when you are done cooking.
20. Before cleaning, make sure that the Air Fryer is off, unplugged and cooled to room temperature.
21. Do not immerse Air Fryer in water or a dishwasher for cleaning. Only the Air Fryer Basket and Tray may be washed with a sponge and warm, soapy water. The Air Fryer Basket and Tray are dishwasher safe.
22. The Air Fryer housing is NOT dishwasher safe.
23. Use a non-abrasive cleaner, soft pad or cloth to clean both the Air Fryer Basket, Tray and exterior of the Air Fryer. Do not use a scouring pad.
24. Store Air Fryer in a cool, dry location.
25. In case of any electric emergency, such as a fire, call 911.

SAVE THESE INSTRUCTIONS.

SAFETY INSTRUCTIONS

IMPORTANT SAFEGUARDS

SHORT CORD INSTRUCTIONS

A short power supply cord is provided to reduce the hazards of entanglement or tripping over a longer cord. Longer detachable power supply cords or extension cords are available and may be used if care is exercised in their use. If a longer detachable power supply extension cord is used:

1. The marked electrical rating of the extension cord should be at least as great as the electrical rating of the appliance.
2. The cord should be arranged so that it will not drape over the countertop or tabletop where it can be pulled on by children or tripped over unintentionally.

POWER CORD SAFETY TIPS

1. Never pull or yank on the cord or the appliance.
2. To insert the plug, grasp it firmly and guide it into the outlet.
3. To disconnect appliance, grasp the plug and remove it from the outlet.
4. Before each use, inspect the power cord for cuts and/or abrasion marks. If any are found, this indicates that the appliance should be serviced, and the power cord replaced. Please contact Chefman® Customer Support for assistance.
5. Never wrap the cord tightly around the appliance, as this could place undue stress on the cord where it enters the appliance and cause it to fray and break.

DO NOT OPERATE APPLIANCE IF THE POWER CORD SHOWS ANY DAMAGE OR IF THE APPLIANCE WORKS INTERMITTENTLY OR STOPS WORKING ENTIRELY.

*California Proposition 65:
(Applicable for California Residents only)*



WARNING:
Cancer and Reproductive Harm -
www.P65Warnings.ca.gov.



**Do not place the appliance
on a stovetop or any other
hot surface.**

FEATURES

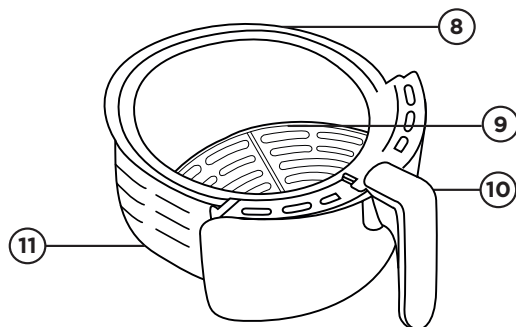
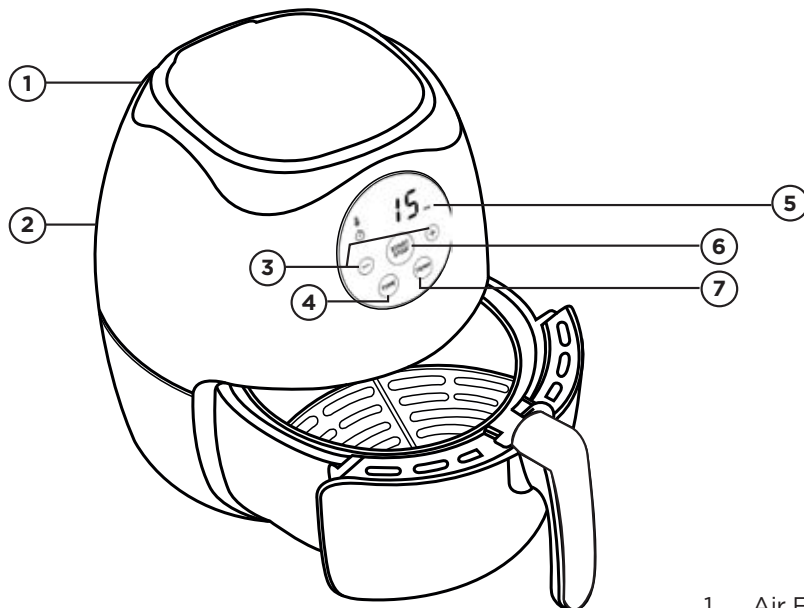

1. Air Fryer
2. Air Fryer Vents
3. Increase/Decrease Buttons
4. Time Button
5. Control Panel/Display
(Display TOGGLES BETWEEN Remaining Time and Temp when Air Fryer is in use)
6. Start/Stop Button
7. Temperature Button
8. Air Fryer Basket
9. Removable Tray
10. Handle on Removable Basket
11. Basket Vents

OPERATING INSTRUCTIONS

BEFORE FIRST USE

Remove all packing materials and stickers from the inside and outside of the Air Fryer. Gently wipe down exterior with a damp cloth or paper towel. **WARNING:** Never immerse the Air Fryer or its plug in water or any other liquid. It is NOT dishwasher safe.

Use the Basket Handle to remove the Air Fryer Basket from the Air Fryer. Use the handle in the center of the tray to remove the tray. Use a sponge and warm, soapy water to wash the inside and outside of the Air Fryer Basket and Tray. Do not use abrasive cleaning agents or scouring pads. The Air Fryer Basket and the Tray are dishwasher safe. Dry thoroughly.

Read all instructions and follow them carefully.

HOW TO USE

1. Prepare the Air Fryer Basket.

Use the Handle in the center of the tray to insert the tray into the Air Fryer Basket. Press down to ensure it is secure and in a leveled position. There should be a small amount of space between the Tray and bottom of the Air Fryer Basket.

NOTE: Do not use the Air Fryer Basket without the Tray. The Tray allows for proper air circulation, which promotes even cooking.

CAUTION: Never fill the Air Fryer Basket with oil. Unlike deep fryers, air fryers require little to no oil to produce crispy results. If you choose to use oil, toss food with oil in a separate bowl and then transfer food to the Air Fryer Basket.

Tip: Oil promotes browning and extra-crispy results. Use a couple of teaspoons when making foods from scratch like French fries or chicken nuggets.

2. Place food on tray.

Refer to the chart on **page 8** for recommended minimum and maximum amounts for many types of food. Never fill the Air Fryer Basket higher than the “Max” line embossed on the inside of the Air Fryer Basket.

Refer to the chart on **page 8** for recommended cooking times, temperatures and tips.

OPERATING INSTRUCTIONS

3. Put the Air Fryer Basket into the Air Fryer.

Use the Basket Handle to insert Air Fryer Basket into the Air Fryer. Push closed.

4. Plug in the Air Fryer.

The entire display will illuminate for a moment and then flash off. The Start/Stop button will remain illuminated.

NOTE: The Air Fryer will not turn on if the Air Fryer Basket is not fully in place in the closed position.

5. Turn on the Air Fryer.

Lightly press the Start/Stop button to “wake” the Air Fryer. Once the Air Fryer is in Wake Mode, the time and temperature will toggle back and forth on the display and all buttons will be illuminated. The desired cooking time and temperature may now be set.

NOTE: After twenty minutes of inactivity, the Air Fryer will enter Sleep Mode. Wake by lightly pressing the Start/Stop button. To enter Sleep Mode manually, hold the Start/Stop button for five seconds. The Air Fryer will then beep once and enter Sleep Mode.

6. Set desired cooking time and temperature.

Adjust the Time:

Lightly press the Time button. The little clock icon located on the left of the displayed time will blink and the Air Fryer will beep once. Lightly press the Increase/Decrease button to select desired time.

Maximum cooking time is 60 minutes.

Adjust the Temperature:

Lightly press the Temp button. The little thermometer icon located on the left of the displayed temperature will blink and the Air Fryer will beep once. Lightly press the Increase/Decrease button to select desired temperature.

Minimum temperature is 200°F and 90°C. Maximum temperature is 400°F and 200°C.

OPERATING INSTRUCTIONS

Change the Temperature from Fahrenheit to Celsius:

Lightly press and hold the Temp button for four seconds. The little °F located to the right of the displayed temperature will change to °C. Repeat to switch back to Fahrenheit.

7. Start cooking.

After setting the time and temp, press the Start/Stop button to start cooking. While the Air Fryer is cooking, all of the buttons will remain illuminated and the temperature and remaining time will toggle on the display.

To check the food while the Air Fryer is cooking, use the Basket Handle to gently pull out the Air Fryer Basket. Be sure to pull basket out in a straight motion to avoid spills. All of the buttons will turn off once you pull out the basket, but the program will be saved until you resume cooking. Use the Basket Handle to shake and redistribute the food inside the Air Fryer Basket, if necessary, and push the Air Fryer Basket to resume cooking.

8. Enjoy your air-fried food.

Once the timer completely counts down, the Air Fryer and the screen will turn off — only the Start/Stop button will remain illuminated. The Air Fryer will also beep loudly three times, indicating that it is done cooking.

Use the Basket Handle to pull out the Air Fryer Basket. Remove basket carefully by pulling out straight to prevent oil spillage. Use protective gloves and/or tongs to carefully transfer the hot food to a serving plate.

CAUTION: The Air Fryer Basket will be hot after cooking.

Place the hot Air Fryer Basket on a wire rack or trivet to cool.

9. Unplug the Air Fryer.

Use the Cleaning and Maintenance instructions on **page 11** to clean the Air Fryer and its parts after every use.

COOKING TIPS

- Almost any food that is traditionally cooked in the oven can be air fried.
- Foods cook best and most evenly when they are of similar size and thickness.
- Smaller pieces of food require less cooking time than larger pieces.
- For best results in the shortest amount of time, air fry food in small batches. Avoid stacking or layering when possible.
- Most prepackaged foods do not need to be tossed in oil before air frying. Most already contain oil and other ingredients that enhance browning and crispiness.
- Frozen appetizers and hors d'oeuvres air fry very well. For best results, arrange them on the tray in a single layer.
- If layering foods, be sure to shake the basket halfway through (or flip food) to promote even cooking.
- Toss foods you are preparing from scratch, such as French fries or other vegetables, with a small amount of oil to promote browning and crispiness.
- When air frying fresh vegetables, make sure to pat them dry completely before tossing with oil and air frying to ensure maximum crispiness.
- When air frying battered food, stick to thick, pasty batters. Thin batters, such as the batters used to make tempura, will run and not set fast enough like they do in a deep fryer.
- Coating battered foods in panko (Japanese-style breadcrumbs) or puffed rice, and then spraying them with oil, helps create crispy, healthier versions of your favorite fried foods.
- Air fryers are great for reheating food, including pizza. To reheat your food, set the temperature to 300°F for up to 10 minutes.

COOKING TIPS

The temperatures and times recommended below are based off of the listed recommended amounts and weights. If using a smaller amount or weight, check food sooner than the recommended time because it will likely cook faster.

Type	Amount	Time (mins)	Temp (°F)	Shake/Flip	Cooking Tip
Bacon	4 pieces	6 (chewy) 8 (crispy)	400	No	After cooking, use tongs to transfer bacon to a paper towel lined plate.
Chicken Breast (Thick, about 8 oz)	About 3 pieces	25-30	375	Yes	Brush with oil, season with salt and desired spices.
Chicken Drumsticks/Thighs (5 oz each)	About 5 pieces	16-18	400	No	Season with salt and desired spices.
Chicken Nuggets	About 20 pieces	10	400	Yes	
Chicken Wings (Flats and drumettes separated)	12 pieces	18-20	400	Yes	Season with salt; enjoy as is or, when done, toss in favorite chicken wing sauce.
Fish Sticks (Frozen)	20 pieces	7	400	Yes	
French Fries (Frozen/Thin)	1.5lbs	16-18	400	Yes	
French Fries (Frozen/Thick)	1.5lbs	20	400	Yes	
French Fries (Homemade cut into 1/4 x 1/4 inch pieces)	2lbs	20-25	400	Yes	Rinse with cold water, pat dry, toss with 1 tbsp olive oil, season with salt and desired spices; use tongs to toss during cooking.
Hamburgers (4 oz each)	2 patties	12 (medium)	375	Yes	Brush with oil, season with salt and desired spices such as freshly ground black pepper and garlic powder.
Mozzarella Sticks (Frozen)	20 pieces	7	400	Yes	
Pork Chops (Bone-in, about 8 oz)	2 8 oz pieces	12	400	Yes	Season with salt and desired spices.

COOKING TIPS

Type	Amount	Time (mins)	Temp (°F)	Shake/Flip	Cooking Tip
Pork-Chops (Boneless, about 3 oz)	4 pieces	15	400	No	Season with salt and desired spices.
Steak	1-1 1/3lb	12 (medium doneness)	400	No	Season with salt and desired spices.
Salmon (1 inch wide, 4.5 oz)	3 pieces	10 (medium doneness)	400	No	Brush skin with oil and place on tray skin-side down. Season with salt and desired spices.
Shrimp (large)	2lbs	12	400	Yes	Pat dry, toss with 1/2 tbsp olive oil, season with salt and desired spices; shake often.

Note: This table is only a guide and does not contain exact recipes.

Note: Use extreme caution while handling hot food in fryer basket. Excess oil will drip into basket when preparing greasy foods. Empty basket after every use.

TROUBLESHOOTING GUIDE

Problem	Possible Cause	Solution
The Air Fryer is not working/will not turn on.	The appliance is not plugged in.	Insert plug into the electrical outlet.
	The timer was not set.	Press the Time button and use the increase/decrease buttons to set desired cook time. Press the Start button to turn on the Air Fryer.
	The Air Fryer Basket is not completely pushed into place.	Use the Basket Handle to push basket securely into place.
The ingredients fried with the Air Fryer are not done.	The basket is overcrowded.	Put smaller batches of ingredients in the basket to fry more evenly.
	The set temperature is too low.	Press the Temperature button and use the increase/decrease buttons to adjust to a higher temperature.
The ingredients are fried unevenly in the Air Fryer.	Certain ingredients need to be shaken halfway through.	Shake halfway through the cooking time.
Fried snacks are not crispy when they come out of the Air Fryer.	The snack was meant to be prepared in a traditional deep fryer.	Lightly brush or spray some oil onto the snacks for a crispier result.
The basket will not slide into the appliance properly.	There are too many ingredients in the basket.	Do not fill the basket above the MAX fill line.
	The basket is not placed in the Air Fryer correctly.	Push the basket into the Air Fryer until you hear a click.
There is white smoke coming out of the Air Fryer.	Greasy ingredients are being prepared.	Frying greasy ingredients causes a large amount of oil to leak into the basket. This will produce smoke but does not affect the appliance or cooking of your food.
	The pan still contains greasy residue from previous use.	Make sure the Air Fryer basket is cleaned properly after every use. The Air Fryer basket is dishwasher safe.
Fresh French fries are fried unevenly in the Air Fryer.	Cut potatoes weren't tossed with oil evenly.	After soaking, dry cut potatoes completely and toss with oil in a large bowl; then add to Air Fryer Basket.
	Cut potatoes were not rinsed properly before air frying.	Soak cut potatoes in cold water for 30 minutes. Rinse, and dry completely.

COOKING TIPS

Problem	Possible Cause	Solution
Fresh French fries are not crispy when they come out of the Air Fryer.	The crispiness of the fries depends on the amount of oil and water in the fries.	Fully dry cut potatoes before tossing with oil or spices.
		Cut the potatoes thinner for crispier results.
		Add more oil for crispier results.
Air Fryer is producing a significant amount of smoke.	High fat content foods, such as sausage, tend to produce a significant amount of smoke when cooked at a high temperature setting.	This will not harm the air fryer or affect the final result of the food, but in order to avoid smoke, fry at a lower temperature.

CLEANING AND MAINTENANCE

- Ensure that the Air Fryer is unplugged before cleaning.
- Once the Air Fryer and Air Fryer Basket are cool, remove the basket from the Air Fryer (if it is not already removed.) Use the handle in the center of the tray to remove the tray.
- Use a sponge and warm, soapy water to wash the inside and outside of the Air Fryer Basket and Tray. Do not use abrasive cleaning agents or scouring pads. The Air Fryer Basket and the Tray are dishwasher safe. Dry thoroughly.
- Gently wipe down exterior with a damp cloth or paper towel. Never immerse the Air Fryer or its plug in water or any other liquid. It is NOT dishwasher safe.
- Store the Air Fryer in a cool, dry place.

TERMS & CONDITIONS

Limited Warranty

Our products are backed by a limited 1-year warranty. To register, follow the instructions on the Chefman® Warranty Registration page in this User Guide.

We offer a limited 1-year warranty from the date of purchase. This warranty is void without proof of purchase within the USA, Canada or Mexico. Service centers and retail stores do not have the right to alter or change the Terms & Conditions of this warranty.

WHAT THE WARRANTY COVERS

• Manufacturer Defects

Chefman® products are warranted against defects in material and workmanship for a period of 1 year from the date of purchase, when used in accordance with the Chefman® User Guide.

• Qualified Replacements

If your product does not work as it should, we will send you a new one. If the product is no longer available, we will replace it with an identical product or one that is comparable.

THIS WARRANTY DOES NOT COVER

- **Misuse** - Damage that occurs from neglectful or improper use of products; damage that occurs as a result of usage with incompatible voltage. See Safety Instructions for information on proper use.
- **Poor Maintenance** - General lack of proper care. See Cleaning & Maintenance Instructions for information on proper maintenance.
- **Commercial Use** - Damage that occurs from commercial use.
- **Altered Products** - Damage that occurs from alterations or modifications by any entity other than Chefman®; removal of rating label.
- **Catastrophic Events** - Damage that occurs from fire, floods or natural disasters.
- **Loss of Interest** - Claims of loss of interest or enjoyment.

CHEFMAN® WARRANTY REGISTRATION

Register your product to extend your warranty for 3 months.

What do I need to register my product?

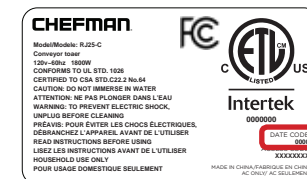

- Contact Information
- Model Number
- Proof of Purchase (i.e. online confirmation, receipt, gift receipt)
- Date code

How do I register my product?

We offer 2 convenient ways to access the Chefman® registration form:

1. Visit chefman.com/register.
2. Scan the QR code below to access the form:



Have a question?

Please reach out to us at Chefman.com/contact.

Need more help?

We're here for you! Contact us at customersupport@chefman.com or 888.315.6553 Monday-Friday.

OTHER LIMITATIONS: ALL WARRANTIES OF ANY KIND WHATSOEVER, EXPRESS, IMPLIED AND STATUTORY, ARE HEREBY DISCLAIMED. ALL IMPLIED WARRANTIES OF MERCHANTABILITY AND FITNESS FOR A PARTICULAR PURPOSE ARE HEREBY DISCLAIMED, PROVIDED THAT IF ANY IMPLIED WARRANTIES OF ANY KIND IS REQUIRED BY ANY JURISDICTION, INCLUDING MERCHANTABILITY AND FITNESS FOR A PARTICULAR PURPOSE, THE DURATION OF SUCH IMPLIED WARRANTY IS LIMITED TO ONE (1) YEAR. THIS WARRANTY DOES NOT COVER, AND CHEFMAN® SHALL NOT BE LIABLE, FOR INCIDENTAL, INDIRECT, SPECIAL OR CONSEQUENTIAL DAMAGES, INCLUDING WITHOUT LIMITATION, DAMAGE TO, OR LOSS OF USE OF THE PRODUCT, OR LOST SALES OR PROFITS OR DELAY OR FAILURE TO PERFORM THIS WARRANTY OBLIGATION. THE REMEDIES PROVIDED HEREIN ARE THE EXCLUSIVE REMEDIES UNDER THIS WARRANTY, WHETHER BASED ON CONTRACT, TORT OR OTHERWISE.

This Warranty gives you specific legal rights, and you may also have other rights that vary from state to state or Province to Province. Some states or Provinces do not allow the exclusions or limitations set forth in this Warranty, so the above limitations or exclusions may not apply to you depending on the jurisdiction of purchase.

Chefman® is a registered trademark of RJ BRANDS, LLC. ETLSM is a registered certification mark of Intertek Testing Services NA, Inc.

CHEFMAN AIR FRYER
RECIPE BOOK

FRYING FIT

Easy, healthy and delicious recipes using
your Chefman Air Fryer





PREP TIME

10 MIN



COOK TIME

5 MIN



SERVINGS

2

CAJUN SHRIMP

INGREDIENTS

- 8 ounces (about 25) large shrimp, peeled and deveined
- ½ tablespoon olive oil
- Lime wedges, for serving

Cajun Spice Mix:

- 2 teaspoons Kosher salt
- ½ tablespoon cayenne pepper
- ½ tablespoon garlic powder
- ½ tablespoon onion powder

1. In a small bowl, combine the Cajun Spice Mix ingredients. Set aside.
2. In a large bowl, combine the peeled and deveined shrimp, olive oil and 1½ tablespoons of the Cajun Spice Mix. Store remaining for another use.
2. Transfer the seasoned shrimp to the tray inside the air fryer basket. Insert basket into Air Fryer.
3. Set the Air Fryer to 400°F and 5 minutes. Press Start. Shake halfway through.
4. When shrimp is opaque and cooked through, transfer to a serving plate. Serve with lime wedges.



Tip: This Cajun Spice Mix is spicy! For a milder version, omit the cayenne and add only ¼ teaspoon black pepper.

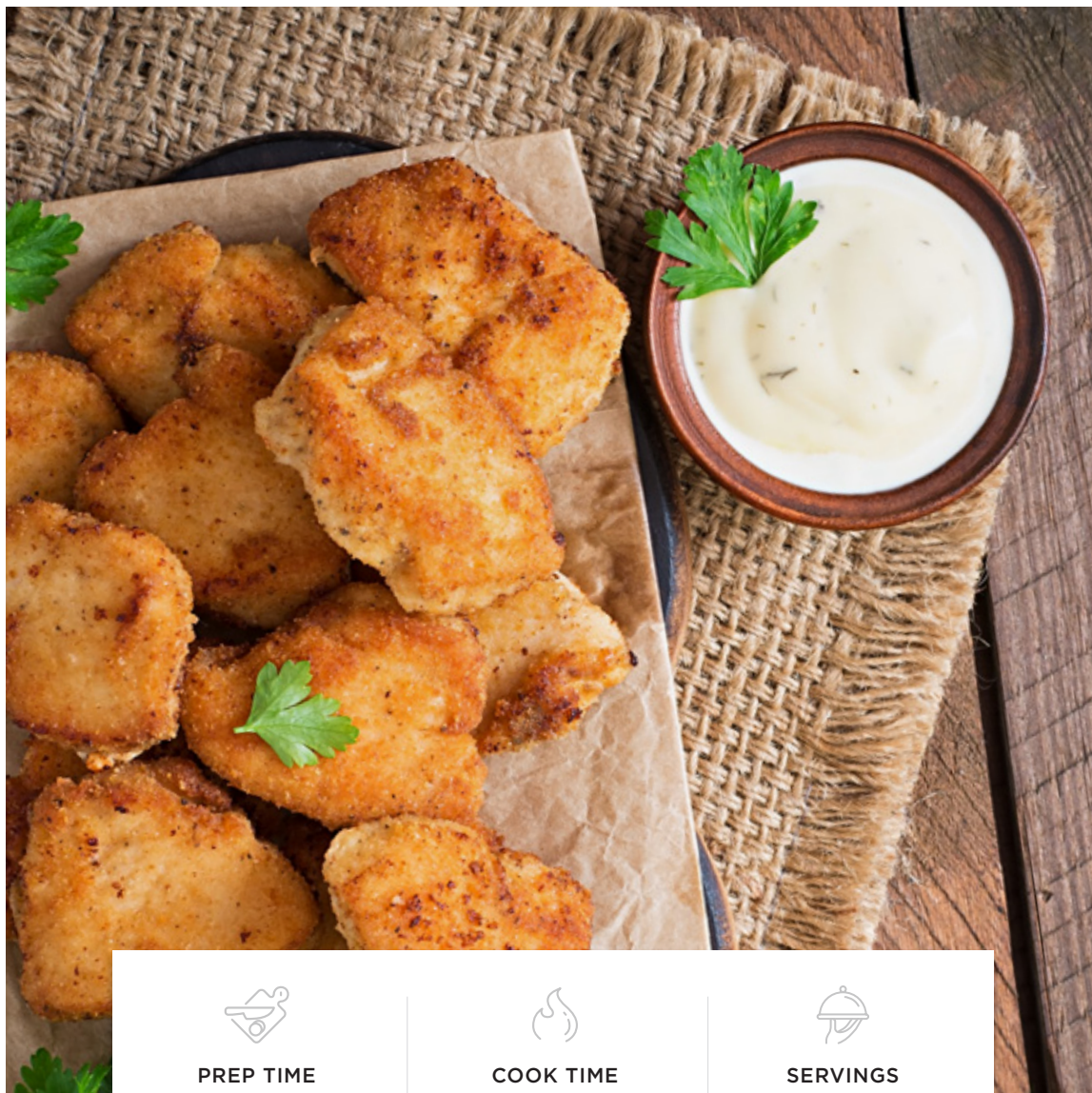

PREP TIME

10 MIN



COOK TIME

20 MIN



SERVINGS

2

CHICKEN NUGGETS

INGREDIENTS

- 2, 6-ounce chicken breasts
- Oil, for spraying

For the breading:

- $\frac{3}{4}$ cup panko bread crumbs
- 2 large eggs, lightly beaten
- 2 tablespoons olive oil
- 1 cup unbleached, all-purpose flour
- 1 pinch salt
- 1 pinch ground black pepper

1. Cut the chicken breasts into 1- to 2-inch cubes. Set aside.
2. Place the flour in a shallow bowl and the eggs in another shallow bowl.
3. In a food processor, chop the panko bread crumbs, olive oil and salt into a fine crumb. Transfer to a third shallow bowl.
4. Dip one chicken cube into the flour, then the egg and then the panko mixture. Place on a plate. Repeat with remaining chicken cubes.
5. Spray the panko-breaded chicken cubes with oil. Transfer half of the chicken to the tray inside the air fryer basket. Insert basket into Air Fryer.
6. Set the Air Fryer to 400°F and 10 minutes. Press Start.
7. When chicken nuggets are golden-brown and fully cooked through, transfer to a serving plate. Repeat with remaining chicken cubes.



Tip: This recipe could also work for chicken fingers. Simply cut into strips instead of cubes and adjust cooking time based on thickness to ensure they are fully cooked through.

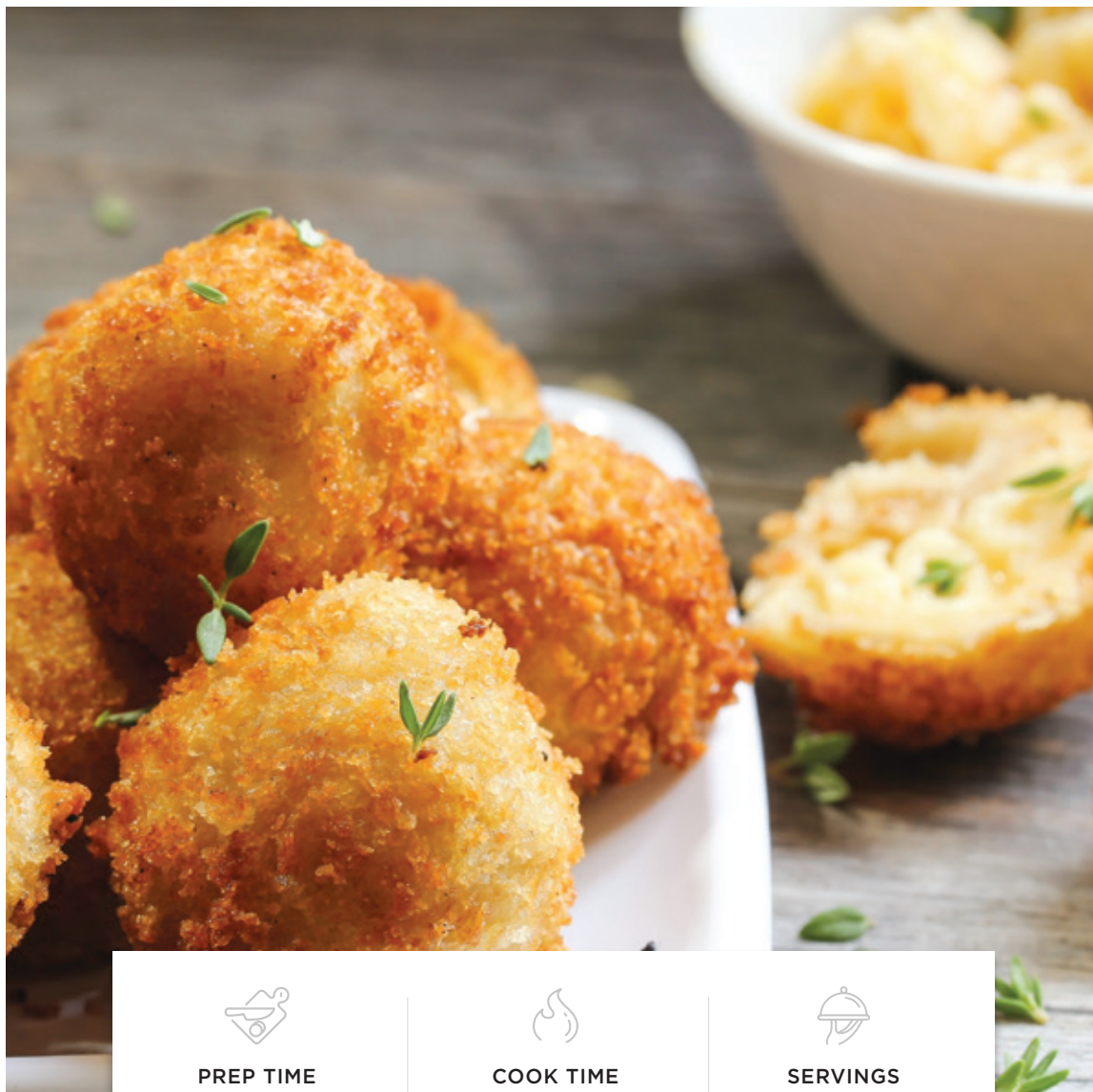

PREP TIME

10 MIN



COOK TIME

20 MIN



SERVINGS

4-6

MAC AND CHEESE BITES

INGREDIENTS

- 3 cups prepared mac and cheese, cooled and refrigerated
- 2 eggs, lightly beaten
- 1 cup bread crumbs
- Oil, for spraying, or 1 tablespoon oil

1. Remove mac and cheese from refrigerator. Scoop 2 tablespoons and, with wet hands, roll into a ball. Place on a plate or baking sheet. Repeat with remaining mac and cheese. Refrigerate until mac and cheese balls are firm, about 4 hours or more.
2. When mac and cheese balls are firm, place the eggs in one shallow bowl and the panko bread crumbs in another. Remove mac and cheese balls from the refrigerator.
3. Dip one mac and cheese ball into the eggs and then the panko. Place on a plate and repeat with remaining.
4. Spray the coated mac and cheese balls with oil, or toss with oil. Transfer half to the tray inside the air fryer basket. Insert basket into Air Fryer.
5. Set the Air Fryer to 400°F and 10 minutes. Press Start.
6. When the mac and cheese balls are golden-brown and warmed through, transfer to a serving plate. Repeat with remaining coated mac and cheese balls.



Tip: This recipe is great for using leftover mac and cheese, and the kids will love it!



PREP TIME

8 MIN



COOK TIME

10 MIN



SERVINGS

2

PANKO GREEN BEANS

INGREDIENTS

- 1 pound fresh green beans, trimmed and strings removed
- 2 eggs, lightly beaten
- 1½ cups panko bread crumbs
- 1 pinch Kosher salt
- 1 pinch cracked black pepper

1. Place the eggs in a shallow bowl. Combine the panko bread crumbs, salt and pepper in another shallow bowl.
2. Dip one of the green beans into the eggs and then the panko. Place on a plate or in a bowl. Repeat with remaining.
3. Spray the coated green beans with oil, or toss with oil. Transfer to the tray inside the air fryer basket. Insert basket into Air Fryer.
4. Set the Air Fryer to 400°F and 10 minutes. Press Start. Shake halfway through.
5. When the green bean fries are golden-brown, transfer to a serving plate.



Tip: If your green beans are too long, you can cut them in half to fit better. Try adding your favorite seasoning in the bread crumbs along with the salt and pepper.



PREP TIME

15 MIN



COOK TIME

30 MIN



SERVINGS

2

PARMESAN REGGIANO SWEET POTATO FRIES

INGREDIENTS

- 2 pounds sweet potatoes, peeled
- 1 tablespoon olive oil
- 2 teaspoons fresh rosemary, chopped
- 1 pinch Kosher salt
- 3 tablespoons grated Parmesan Reggiano cheese

1. Cut the sweet potatoes into even pieces, about 4 inches long and ¼-inch thick.
2. In a large bowl, toss cut sweet potatoes with the olive oil, rosemary and salt. Transfer half of the cut sweet potatoes to the tray inside the air fryer basket. Insert basket into Air Fryer.
3. Set the Air Fryer to 400°F and 15 minutes. Shake halfway through.
4. When sweet potato fries are golden-brown and fully cooked through, transfer to a bowl and toss with half of the Parmesan Reggiano cheese. Repeat with remaining sweet potatoes. Serve immediately.



Tip: Try substituting with your favorite potato, such as Yukon Gold or Russet. Just be sure to soak white potatoes in cold water for 30 minutes, rinse and pat dry completely before cooking.

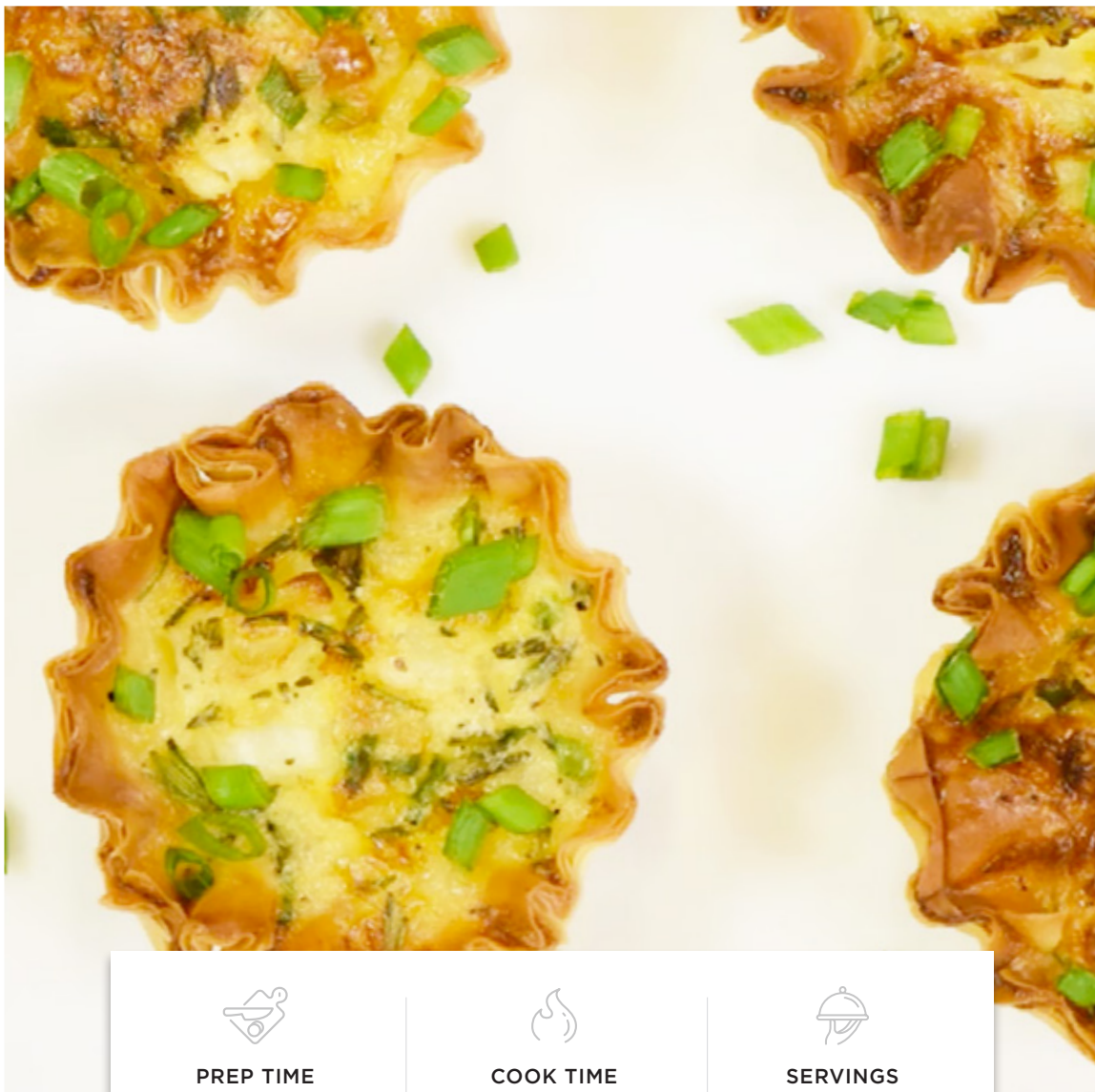

PREP TIME

10 MIN



COOK TIME

30 MIN



SERVINGS

5-6

FRESH HERB QUICHE CUPS

INGREDIENTS

- 1 large egg
- ¼ cup heavy cream
- ¼ cup whole milk
- ½ teaspoons Kosher salt
- ¼ teaspoons ground black pepper
- ½ teaspoon fresh thyme leaves
- 1 teaspoon thinly sliced chives, plus more for garnish
- 2 boxes (15 pieces each) mini phyllo cups

1. In a measuring cup with a spout, whisk together the first six ingredients and 1 teaspoon of the thinly sliced chives.
2. Fill each phyllo cup to the top. Transfer to the tray inside the air fryer basket. Insert basket into Air Fryer.
3. Set the Air Fryer to 375°F and 15 minutes. Press Start.
4. Check the phyllo cups at 12 minutes. When the egg mixture is just set, transfer to a serving plate. Repeat with remaining phyllo cups. Serve warm or room temperature.



Tip: Add Tabasco sauce or other hot pepper sauce for a spicy kick.

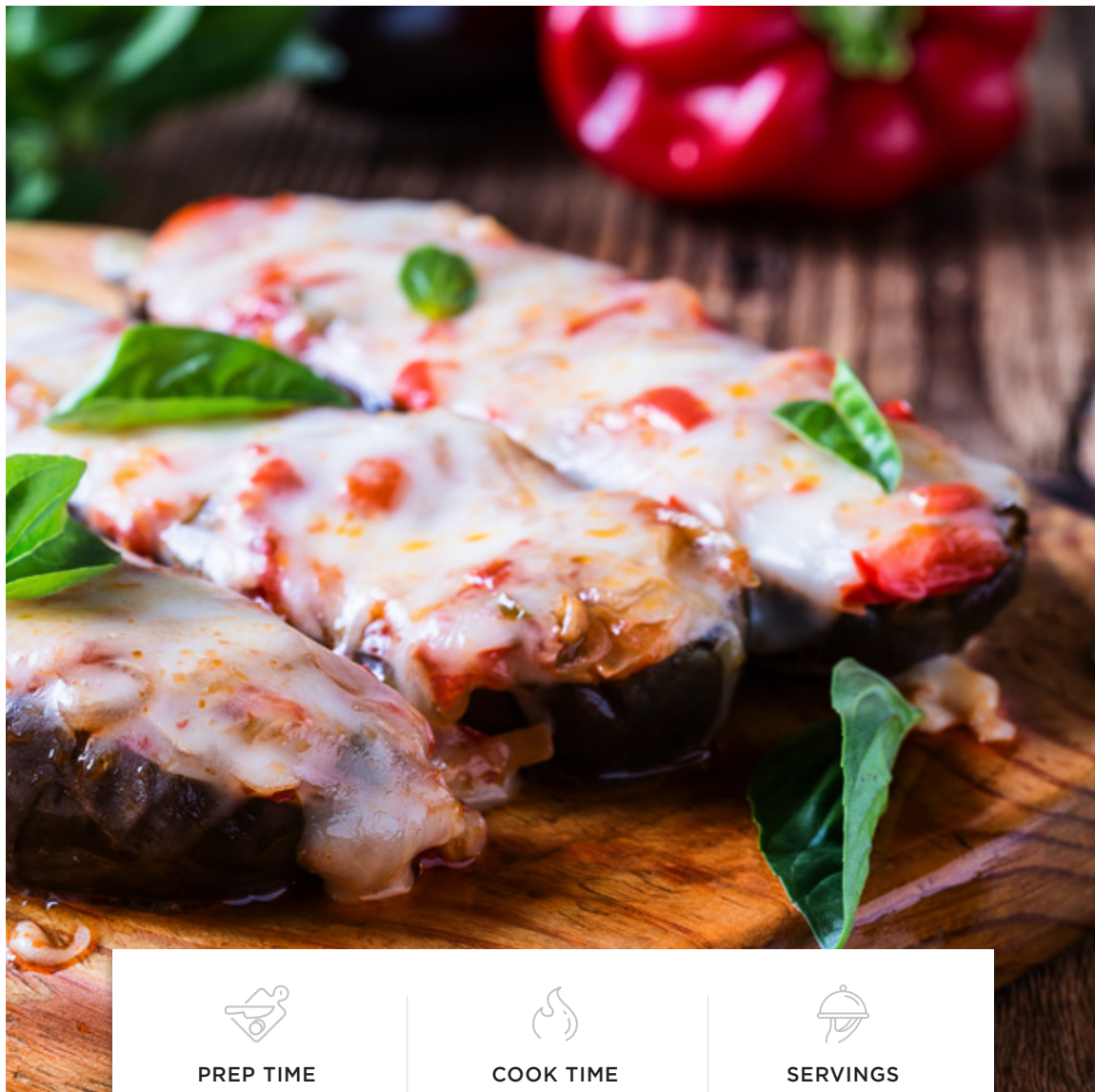

PREP TIME

10 MIN



COOK TIME

34 MIN



SERVINGS

2

EGGPLANT PARMESAN

INGREDIENTS

- 2 baby eggplants, about 6.5 ounces each, cut in half lengthwise and stems trimmed
- 3 tablespoons olive oil
- 1 teaspoon Kosher salt
- ½ teaspoon ground black pepper
- 1 scant cup marinara sauce
- 4 slices mozzarella cheese
- ¼ cup grated Parmesan cheese
- ¼ cup fresh basil leaves

1. Brush the eggplant halves with the olive oil and sprinkle with the salt and pepper. Transfer 2 halves to the tray inside the air fryer basket. Insert basket into Air Fryer.
2. Set the Air Fryer to 375°F and 15 minutes. Press Start.
3. After 15 minutes, spoon ¼ scant cup marinara sauce onto each eggplant half. Sprinkle each with 1 tablespoon of the Parmesan cheese and top each with 1 slice of mozzarella cheese. Insert air fryer basket back into the Air Fryer. Set to 400°F and 2 minutes. Press Start.
4. When cheese is melted, carefully use a spatula to transfer eggplant parmesan to a serving plate. Repeat with remaining eggplant halves.
5. Before serving, tear the basil into small pieces and sprinkle on top.



Tip: Remember that the air fryer basket has vents. If sauce drips onto the bottom of the basket, be sure to empty it before cooking the second batch to avoid spillage.

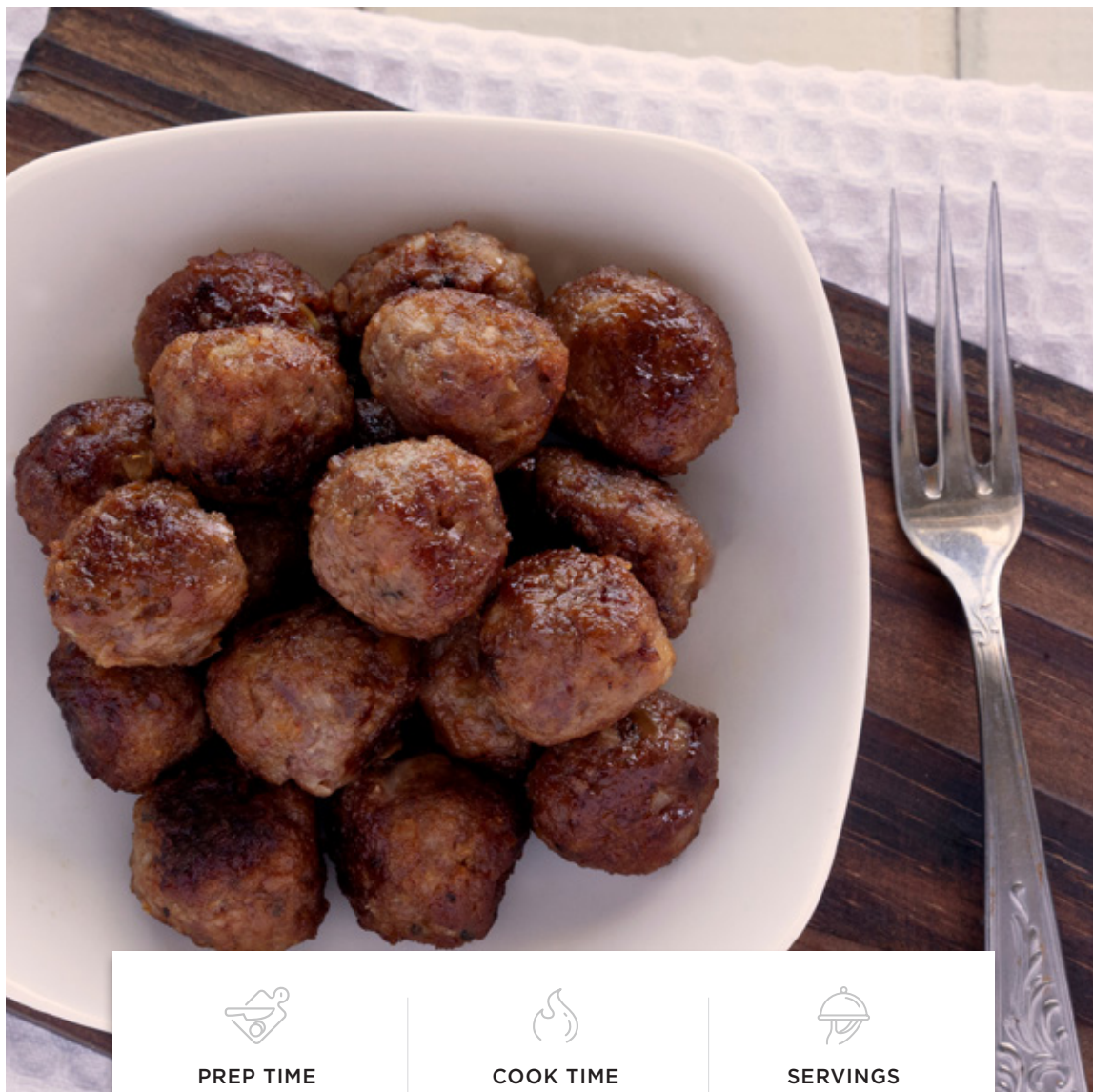

PREP TIME

10 MIN



COOK TIME

20 MIN



SERVINGS

5

SPICY FRIED MEATBALLS

INGREDIENTS

- 1 pound ground beef or chuck
- 1 onion, finely chopped
- 1 clove garlic, minced
- 1 large egg, beaten
- ¼ cup panko bread crumbs
- 1 teaspoon Kosher salt
- 1 teaspoon dark chili powder
- ¼ teaspoon ground black pepper
- 1 tablespoon olive oil

1. In a large bowl, use your hands to loosely combine all of the ingredients except for the olive oil.
2. Scoop about 1 tablespoon of the meat mixture and roll it into a ball. Place on a plate.
3. Brush meatballs with olive oil. Transfer half of the meatballs to the tray inside the air fryer basket. Insert basket into Air Fryer.
4. Set the Air Fryer to 400°F and 10 minutes. Press Start. Shake halfway through.
5. When the first batch of meatballs are browned and fully cooked through, transfer to a serving plate. Repeat with remaining meatballs.



Tip: You can substitute chili powder with your favorite spice.

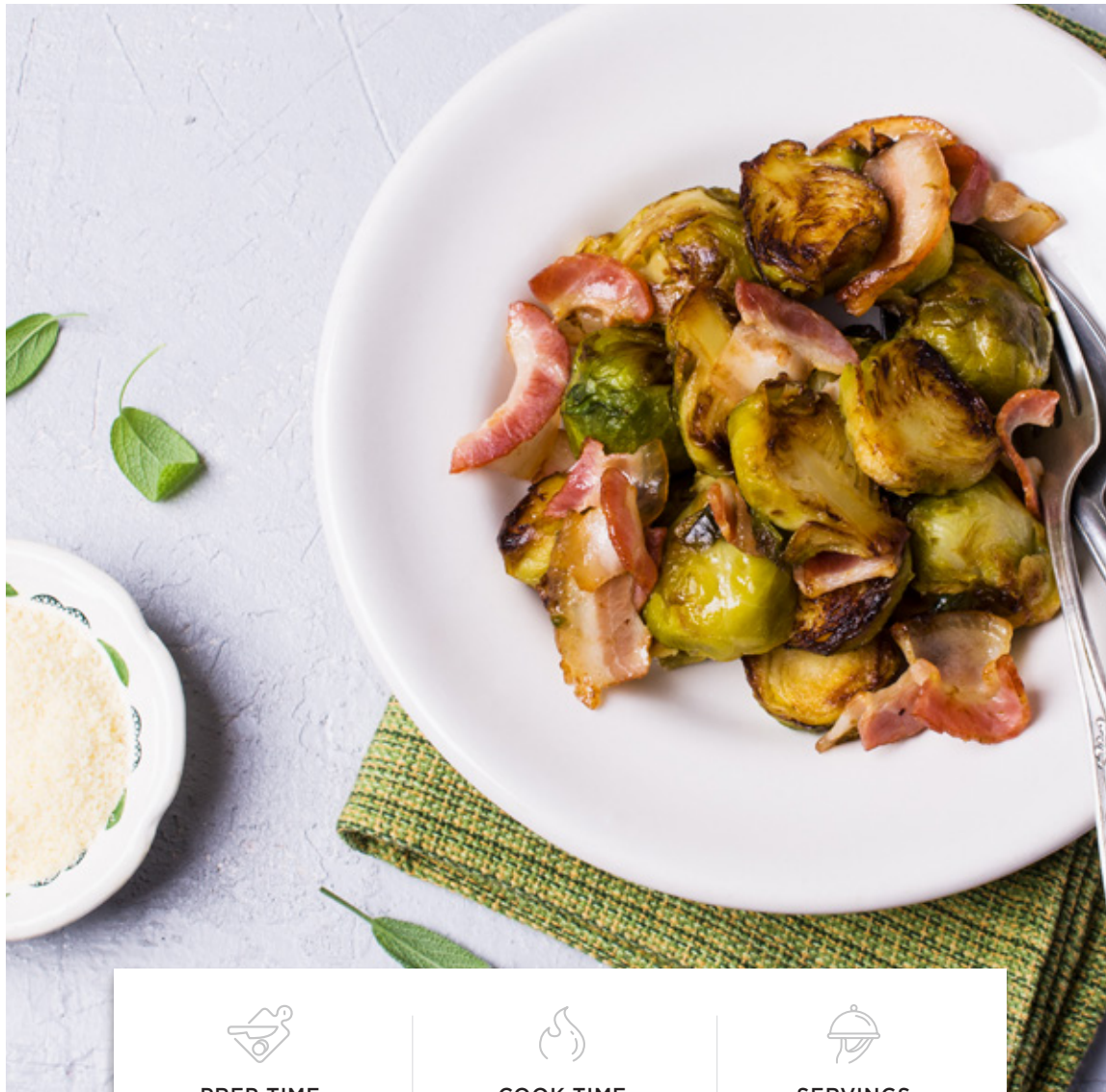

PREP TIME

5 MIN



COOK TIME

15 MIN



SERVINGS

2-4

BACON PARMESAN BRUSSEL SPROUTS

INGREDIENTS

- 4 strips bacon
- 16 - 20 Brussels sprouts, cut in half lengthwise
- 1 tablespoon olive oil
- ½ tablespoon garlic salt
- ½ tablespoon onion powder
- ½ teaspoon Kosher salt
- ¼ teaspoon ground black pepper
- Parmesan cheese
- Balsamic glaze

1. Place the bacon on the tray inside the air fryer basket. Insert basket into Air Fryer.
2. Set the Air Fryer to 400°F and 6 minutes. Press Start.
3. Check the bacon at 5 minutes. When it is browned and crispy, remove from Air Fryer and place on a plate to cool. Set aside.
3. In a large bowl, combine the remaining ingredients except for the Parmesan cheese and balsamic glaze. Transfer Brussels sprouts to the tray inside the air fryer basket. Insert basket into Air Fryer.
4. Set the Air Fryer to 400°F and 10 minutes. Press Start. Shake halfway through.
5. When Brussels sprouts are crispy and mostly cooked through, transfer to a serving plate. Sprinkle with Parmesan cheese and drizzle with balsamic glaze.
6. Crumble cooked bacon and sprinkle on top.



Tip: Keep an eye on the bacon while it's air frying. You'll be surprised how quickly it crisps up.

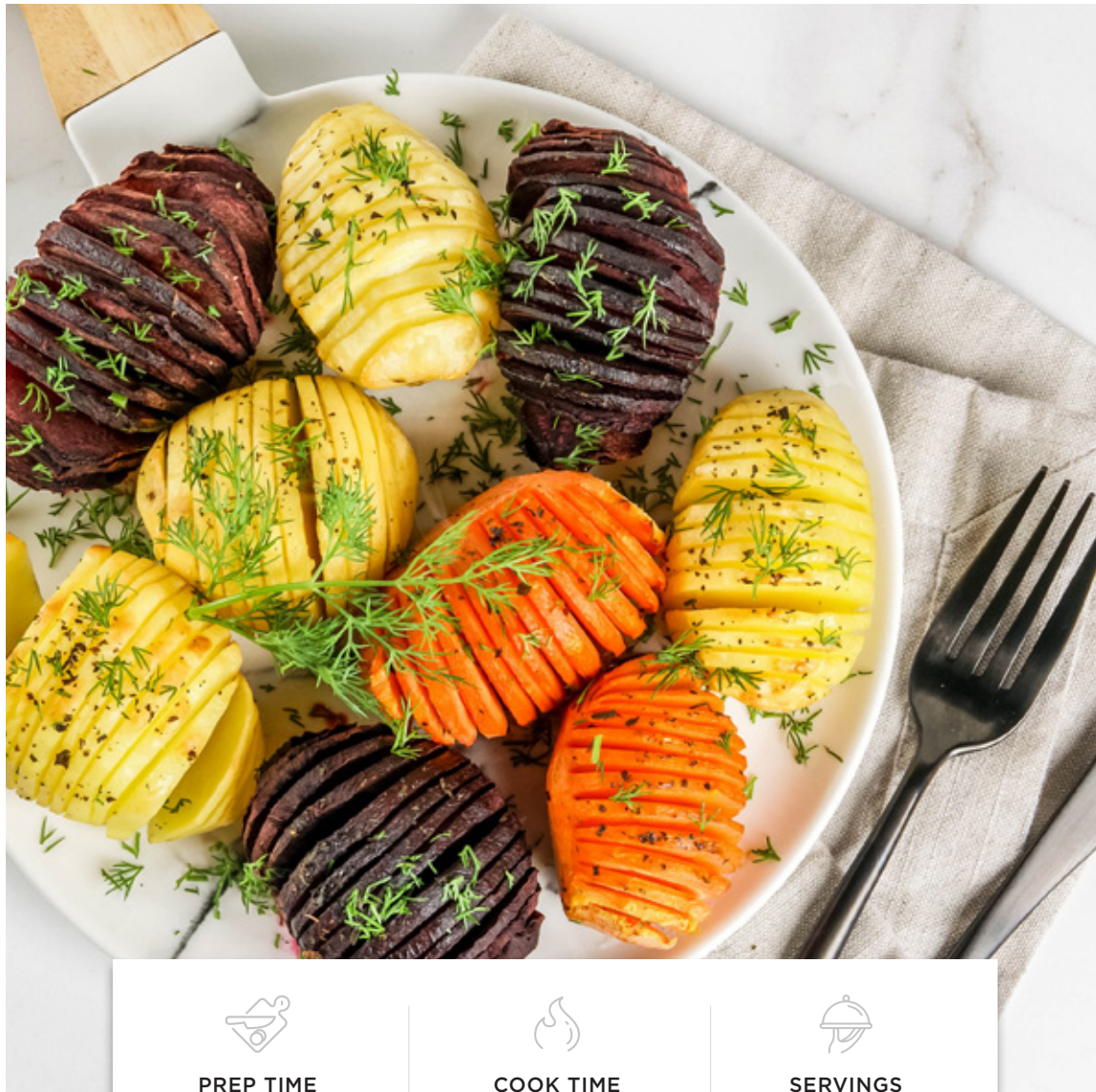

PREP TIME

10 MIN



COOK TIME

50 MIN



SERVINGS

5

HASSELBACK TRIO

INGREDIENTS

- 4 small potatoes, about 6 ounces each, peeled
- 2 small sweet potatoes, about 6 ounces each, peeled
- 2 small beets, about 4 ounces each, scrubbed
- 2 tablespoons olive oil
- ¼ cup grated or shredded Asiago cheese
- 1 teaspoon Kosher salt
- ¼ teaspoon onion powder
- 1 pinch cracked black pepper
- 2 tablespoons dill, finely chopped
- Sour cream, for serving, optional

1. Cut the potatoes, sweet potatoes and beets $\frac{3}{4}$ of the way through into $\frac{1}{8}$ -inch slices so that the bottoms stay intact. Do NOT cut the slices all the way through.
2. If cut vegetables are not easy to fan out in your hands, trim the bottoms so the cuts still remain intact but the bottoms become thinner.
3. Brush each with a generous amount of olive oil and sprinkle with salt, onion powder and pepper. Transfer half to the tray inside the air fryer basket in a single layer. Insert basket into Air Fryer.
4. Set the Air Fryer to 375°F and 25 minutes. Press Start.
5. Check the vegetables at 20 minutes. If they are crispy, brush with more oil and resume cooking. During the last 2 minutes of cooking, sprinkle with cheese and cook for remaining time.
6. When cheese has melted, transfer to a serving plate and sprinkle with fresh dill. If desired, serve with sour cream. Repeat with remaining vegetables.



Tip: Scrub, cut and handle the beets last so their red color doesn't bleed onto the potatoes.

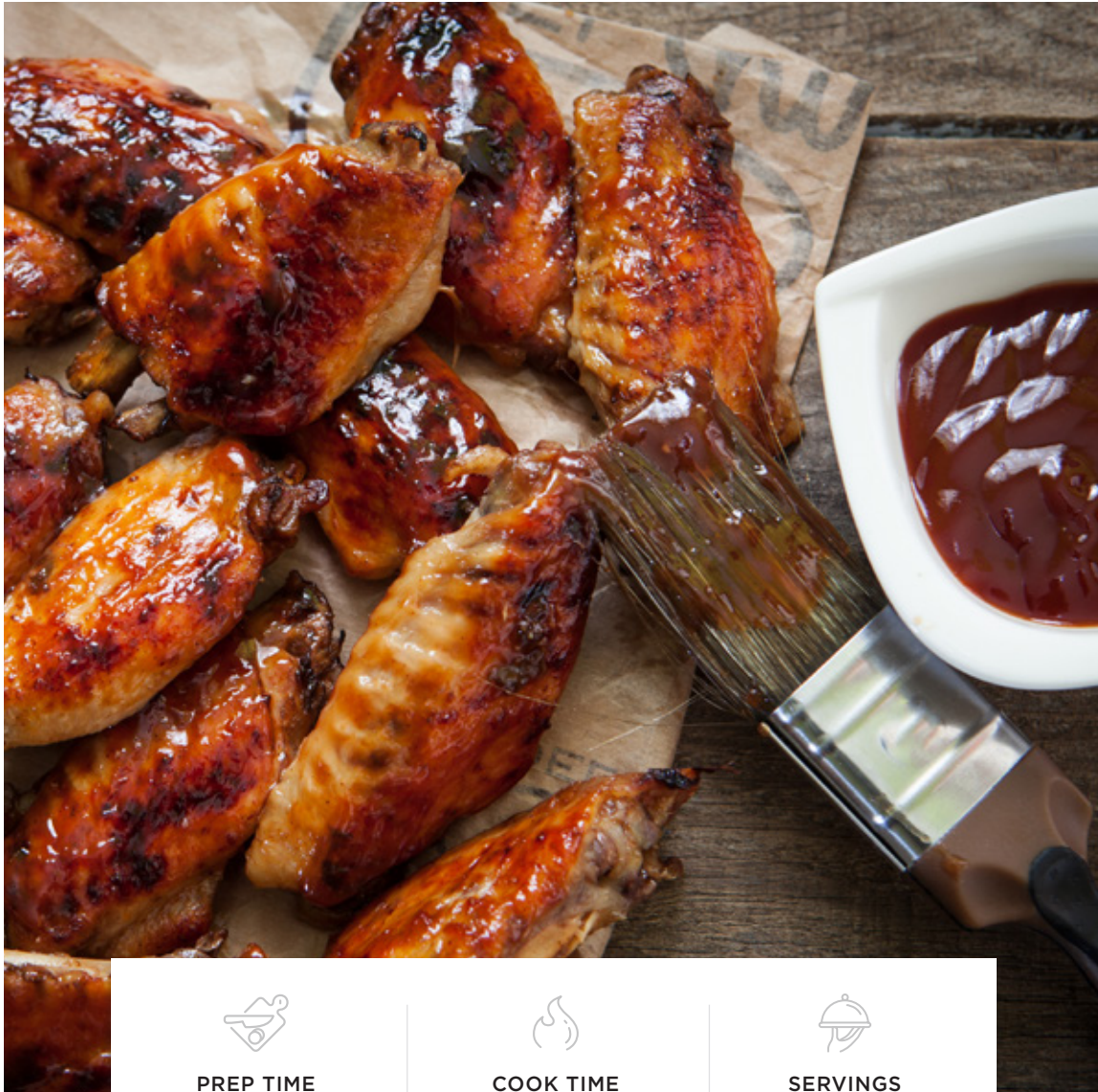

PREP TIME

2 MIN



COOK TIME

40 MIN



SERVINGS

6

BBQ WINGS

INGREDIENTS

- 1 pound chicken wings
- 1 cup BBQ sauce
(Choose your favorite
breading and flavoring).

1. In a large bowl, combine chicken wings and BBQ sauce. Transfer half of the chicken wings to the tray inside the air fryer basket. Insert basket into Air Fryer.
2. Set the Air Fryer to 390°F for 20 minutes. Press Start. Shake halfway through.
3. When chicken wings are ready, transfer to a serving plate. Repeat with remaining chicken wings.



Tip: Place the first batch of wings in aluminum foil to keep warm while the second batch is cooking.

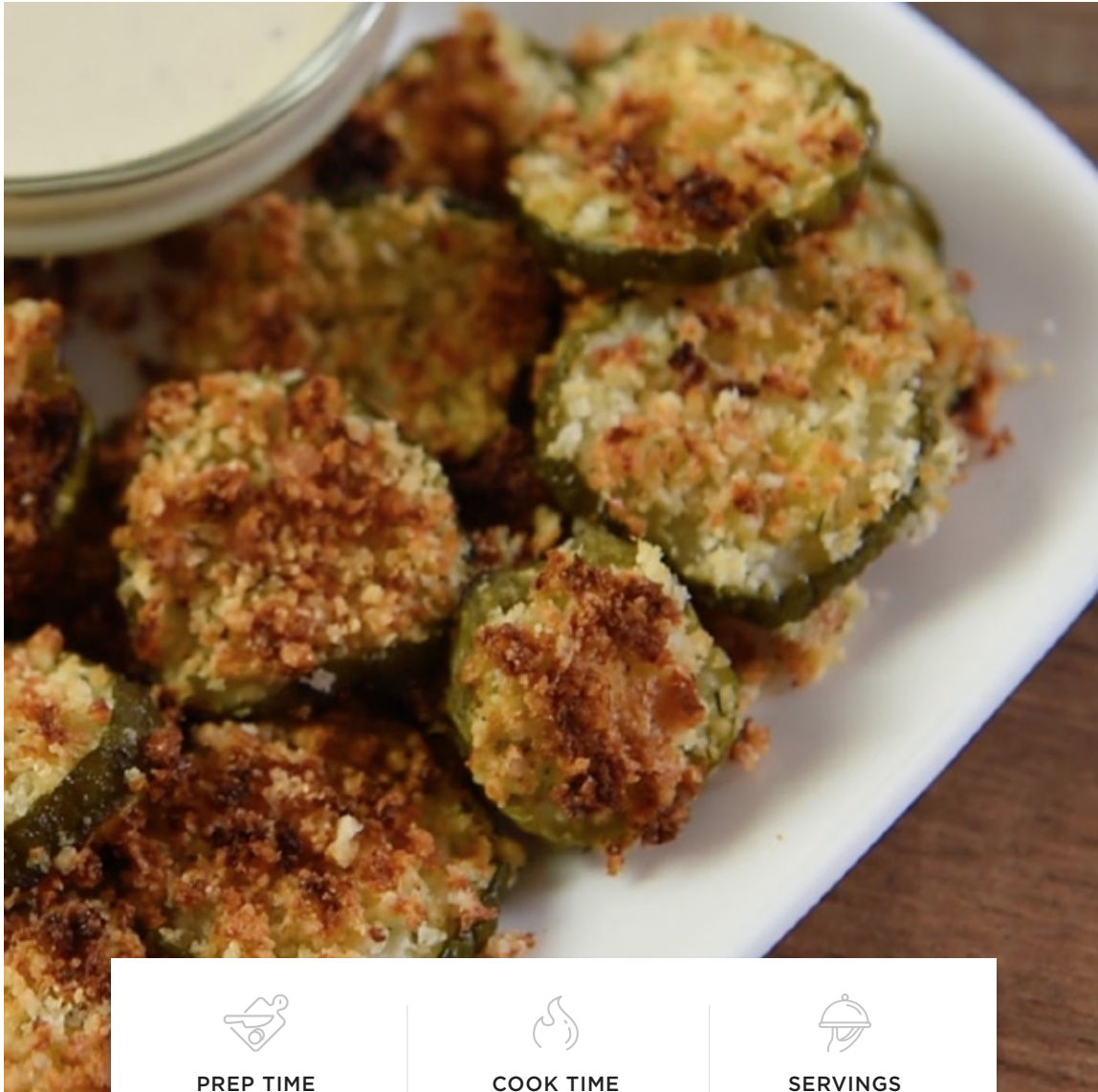

PREP TIME

10 MIN



COOK TIME

20 MIN



SERVINGS

50 CHIPS

PARMESAN PICKLE CHIPS

INGREDIENTS

- 4 garlic dill pickles, about 2 ounces each
- 1 large egg
- 2 tablespoons Parmesan cheese
- ½ cup panko bread crumbs
- Oil, for spraying

1. Cut the pickles into ¼-inch slices. Place on a paper towel-lined plate. Blot with another paper towel to dry and remove as much liquid as possible.
2. In a small bowl, whisk the egg.
3. In another small bowl, combine the panko bread crumbs and Parmesan cheese.
4. Dip the pickle slices into the egg, and then the panko mixture.
5. Spray all of the coated pickle slices with oil. Transfer half to the tray inside the air fryer basket. Insert basket into Air Fryer.
6. Set the Air Fryer to 400°F and 10 minutes. Check with a few minutes left and shake if necessary.
7. When pickle chips are golden-brown, transfer to a serving plate. Repeat with remaining.
8. Serve with Ranch dressing, if desired.



Tip: The more you blot your pickle slices, the more the egg and panko bread crumb coating will stick to your cooked pickle chips.



PREP TIME

10 MIN



COOK TIME

40 MIN



SERVINGS

4

APPLE TURNOVERS

INGREDIENTS

- 3 tablespoons butter, divided
- 1 Granny Smith apple
- ½ lemon
- 2 tablespoons granulated sugar
- ¼ teaspoon ground cinnamon
- 1 pinch ground nutmeg
- 1 sheet frozen puff pastry, thawed
- ⅔ cup confectioners' sugar
- 1 tablespoon water

1. In a small skillet over medium heat, melt butter. Remove from heat.
2. Core apple and cut into ¼-inch dice. Toss in a small bowl with a small squeeze of lemon, the granulated sugar, cinnamon and 1 tablespoon of the melted butter. Set aside.
3. Cut puff pastry sheet into 4 equal squares. Roll each square into a 6-inch by 6-inch square.
4. Place an even amount of the apple mixture into the center of each square. Fold each into a triangle. Use a fork to seal the edges.
5. Brush each apple turnover with an even amount of the melted butter. Put 2 on the tray inside the air fryer basket. Insert basket into Air Fryer.
6. Set Air Fryer to 350°F and 18 minutes. Press Start.
7. While apple turnovers are cooking, in a small bowl combine confectioners' sugar and water to make a royal icing. Set aside.
8. When turnovers are golden-brown, remove from Air Fryer and repeat with remaining turnovers.
9. Drizzle with royal icing and serve.



Tip: This recipe skips the traditional step of softening the apples first in a pan. Apples may be a little crunchier than you're used to, but we love that the prep time is quicker.

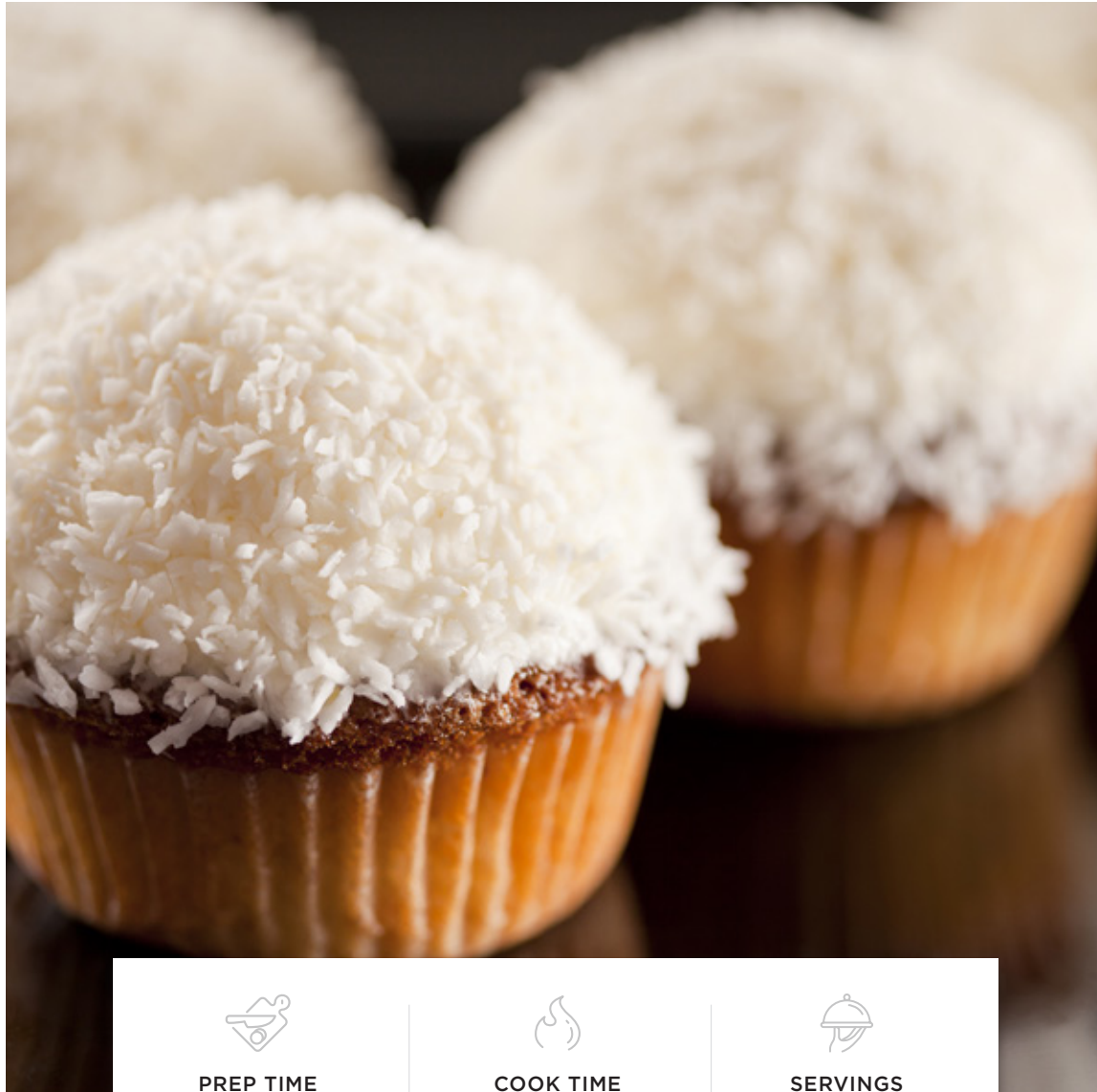

PREP TIME

10 MIN



COOK TIME

36 MIN



SERVINGS

8

SNOWFALL CUPCAKES

INGREDIENTS

- $\frac{3}{4}$ cup granulated sugar
- 6 tablespoons butter, softened at room temp
- $\frac{1}{2}$ teaspoon vanilla extract
- 2 large eggs
- $\frac{1}{4}$ cup unbleached, all-purpose flour
- $\frac{1}{2}$ teaspoon baking soda
- $\frac{1}{4}$ teaspoon table salt
- $\frac{1}{2}$ cup sour cream
- 2 cups shredded coconut

SNOWFALL FROSTING:

- 8 oz. cream cheese, softened at room temp
- 8 tbsp. butter, softened at room temp
- 2 tbsp. vanilla extract
- 1 pinch table salt
- 4 cups confectioners' sugar

1. In a small bowl whisk flour, baking soda and salt. Set aside.
2. In a medium bowl, use a hand blender on speed 1 to cream the sugar and butter until fluffy. Add vanilla and beat in 1 egg at a time until fully combined, about 2 minutes total.
3. Add half of the flour mixture from the small bowl into the medium bowl until just combined. Then, add half of the sour cream until just combined. Repeat.
4. Fill $\frac{2}{3}$ of each silicone cupcake liner with batter.
5. Put 4 of the filled silicone cupcake liners on the tray inside the air fryer basket. Insert basket into Air Fryer.
6. Set the Air Fryer to 350°F and 18 minutes. Press Start.
7. Check the cupcakes at 15 minutes. If the tops are golden-brown, spring back to touch and a toothpick comes out clean when inserted into the center, remove from Air Fryer. Transfer to a cooling rack and repeat with remaining filled cupcake liners.
8. While cupcakes are baking, make the Snowfall Frosting: In a small bowl, use a hand blender on speed 2 to beat the cream cheese and butter until creamy. Add the vanilla and salt. Slowly add in the confectioners' sugar until frosting is smooth and fluffy.
9. Put coconut into a shallow dish. When cupcakes are completely cool, remove the liner, frost the tops and dip into the coconut.

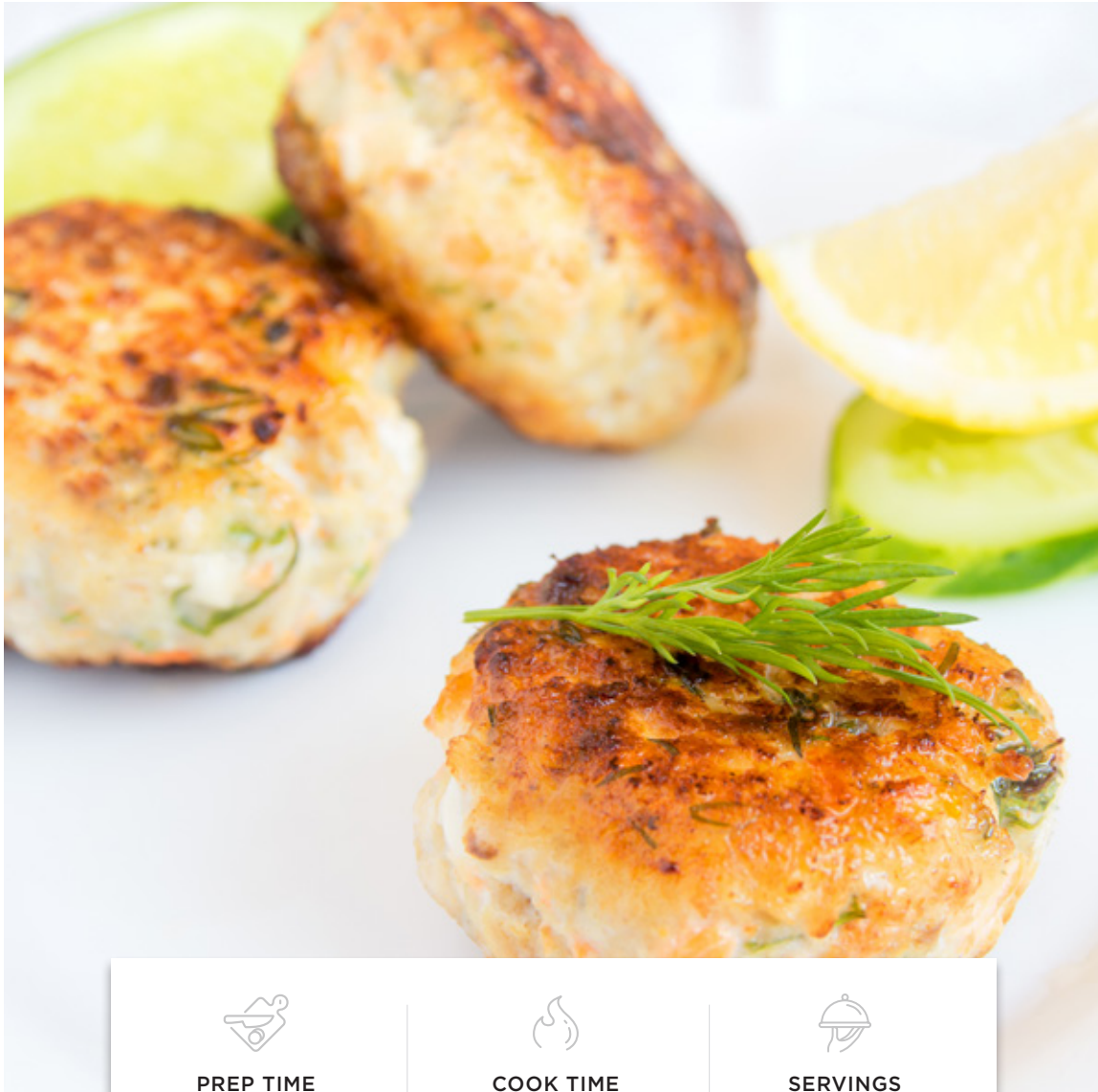

PREP TIME

10 MIN



COOK TIME

36 MIN



SERVINGS

8

CRAB CAKES

INGREDIENTS

- 2 pounds crab meat
- 2 large eggs, lightly beaten
- ½ cup mayo
- 2 tablespoons fresh lemon juice
- ½ cup fresh parsley leaves, chopped
- 1 cup buttery cracker crumbs
- ¼ cup celery, finely chopped
- ¼ cup green bell pepper, finely chopped
- ¼ red bell pepper, finely chopped
- ¼ cup onion, finely chopped
- Olive oil, for brushing

1. In a large bowl, use your hands to gently combine all of the ingredients, except for the olive oil.
2. Scoop ¼ cup of the mixture and form into patties. Place on a plate. 3. Brush with oil.
4. Transfer half of the crab cakes to the tray inside the air fryer basket in a single layer. Insert basket into Air Fryer.
5. Set the Air Fryer to 350°F and 18 minutes. Check when there are 10 minutes remaining and flip if necessary.
6. When crab cakes are golden-brown and cooked through, transfer to a serving dish. Repeat with remaining crab cakes.



Tip: Serve with your favorite dipping sauce or aioli.

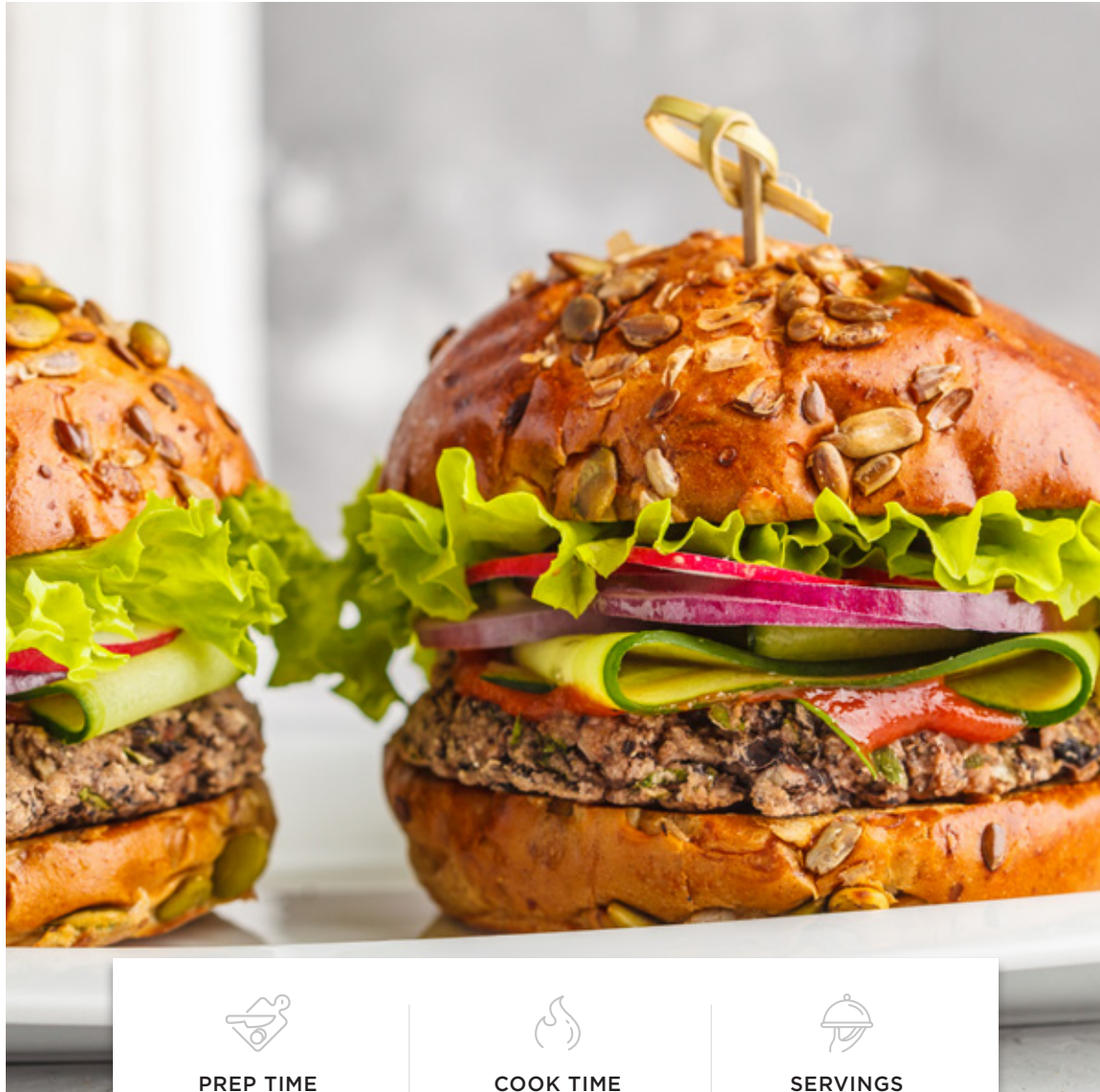

PREP TIME

10 MIN



COOK TIME

36 MIN



SERVINGS

8

CRAB CAKES

INGREDIENTS

- 1 can (15oz) black beans, drained
- 1 small sweet onion, finely chopped
- ½ cup wheat flour
- 1 large egg, lightly beaten
- 1 pinch cayenne pepper
- ½ teaspoon ground cumin
- ¼ teaspoon ground black pepper
- ¼ teaspoon garlic powder
- ¼ teaspoon Kosher salt
- ½ teaspoon oregano
- ¼ teaspoon fresh sage
- ¼ teaspoon fresh thyme

1. In a medium bowl, mash $\frac{3}{4}$ of the drained beans. Store remaining for another use.
2. Add the remaining ingredients to the bowl and mix well.
3. Divide the mixture evenly and form into 4 patties of the same size.
4. Put 2 patties onto the tray inside the air fryer basket. Insert basket into Air Fryer.
5. Set the Air Fryer to 375°F and 10 minutes. Press Start.
6. When patties are cooked through, transfer to a serving plate. Repeat with remaining patties.
7. Serve with your favorite buns and condiments.

CHEFMAN®



CHEFMAN.COM | @MYCHEFMAN

©CHEFMAN 2019