

# **User Manual**

## **5KW with MPPT Solar Charger Inverter/Charger**

# Table Of Contents

<b>ABOUT THIS MANUAL .....</b>	<b>1</b>
Purpose.....	1
Scope.....	1
<b>SAFETY INSTRUCTIONS.....</b>	<b>1</b>
<b>INTRODUCTION .....</b>	<b>2</b>
Product Overview.....	3
<b>INSTALLATION .....</b>	<b>4</b>
Unpacking and Inspection.....	4
Preparation .....	4
Mounting the Unit.....	4
Battery Connection .....	5
AC Input/Output Connection.....	6
PV Connection .....	7
Final Assembly.....	8
Communication Connection.....	9
Dry Contact Signal.....	9
<b>OPERATION.....</b>	<b>10</b>
Power ON/OFF .....	10
Operation and Display Panel .....	10
LCD Display Icons .....	11
LCD Setting.....	13
Display Setting .....	24
Operating Mode Description .....	28
Faults Reference Code .....	30
Warning Indicator.....	31
<b>BATTERY EQUALIZATION .....</b>	<b>31</b>
<b>SPECIFICATIONS .....</b>	<b>33</b>
Table 1 Line Mode Specifications .....	33
Table 2 Inverter Mode Specifications.....	34
Table 3 Charge Mode Specifications .....	35
Table 4 General Specifications .....	35
<b>TROUBLE SHOOTING .....</b>	<b>36</b>
<b>Appendix I: Parallel function .....</b>	<b>37</b>
<b>Appendix II: BMS Communication Installation.....</b>	<b>54</b>
<b>Appendix III: Approximate Back-up Time Table .....</b>	<b>60</b>

# ABOUT THIS MANUAL

## Purpose

This manual describes the assembly, installation, operation and troubleshooting of this unit. Please read this manual carefully before installations and operations. Keep this manual for future reference.

## Scope

This manual provides safety and installation guidelines as well as information on tools and wiring.

# SAFETY INSTRUCTIONS



**WARNING: This chapter contains important safety and operating instructions. Read and keep this manual for future reference.**

1. Before using the unit, read all instructions and cautionary markings on the unit, the batteries and all appropriate sections of this manual.
2. **CAUTION** --To reduce risk of injury, charge only deep-cycle lead acid type rechargeable batteries. If other types batteries are used, follow the manufacturer's instructions carefully.
3. Do not disassemble the unit. Take it to a qualified service center when service or repair is required. Incorrect re-assembly may result in a risk of electric shock or fire.
4. To reduce risk of electric shock, disconnect all wirings before attempting any maintenance or cleaning. Turning off the unit will not reduce this risk.
5. **CAUTION** – Only qualified personnel can install this device with battery.
6. **NEVER** charge a frozen battery.
7. For optimum operation of this inverter/charger, please follow required spec to select appropriate cable size. It's very important to correctly operate this inverter/charger.
8. Be very cautious when working with metal tools on or around batteries. A potential risk exists to drop a tool to spark or short circuit batteries or other electrical parts and could cause an explosion.
9. Please strictly follow installation procedure when you want to disconnect AC or DC terminals. Please refer to INSTALLATION section of this manual for the details.
10. Fuses are provided as over-current protection for the battery supply.
11. GROUNDING INSTRUCTIONS -This inverter/charger should be connected to a permanent grounded wiring system. Be sure to comply with local requirements and regulation to install this inverter.
12. NEVER cause AC output and DC input short circuited. Do NOT connect to the mains when DC input short circuits.
13. **Warning!!** Only qualified service persons are able to service this device. If errors still persist after following troubleshooting table, please send this inverter/charger back to local dealer or service center for maintenance.

# INTRODUCTION

This off-grid PV inverter can provide power to connected loads by utilizing PV power, utility power and battery power.

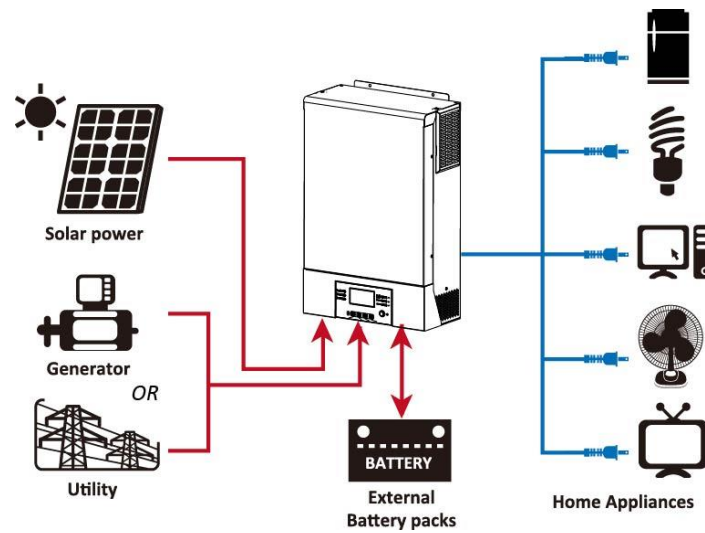

**Figure 1 Basic PV System Overview**

Depending on different power situations, this inverter is designed to generate continuous power from PV solar modules (solar panels), battery, and the utility. When MPP input voltage of PV modules is within acceptable range (see specification for the details), this inverter is able to generate power to feed the grid (utility) and charge battery. Galvanic isolation designed between PV/DC and AC output, so that user could connect any type of PV array to this inverter. See Figure 1 for a simple diagram of a typical solar system with this inverter.

## Product Overview

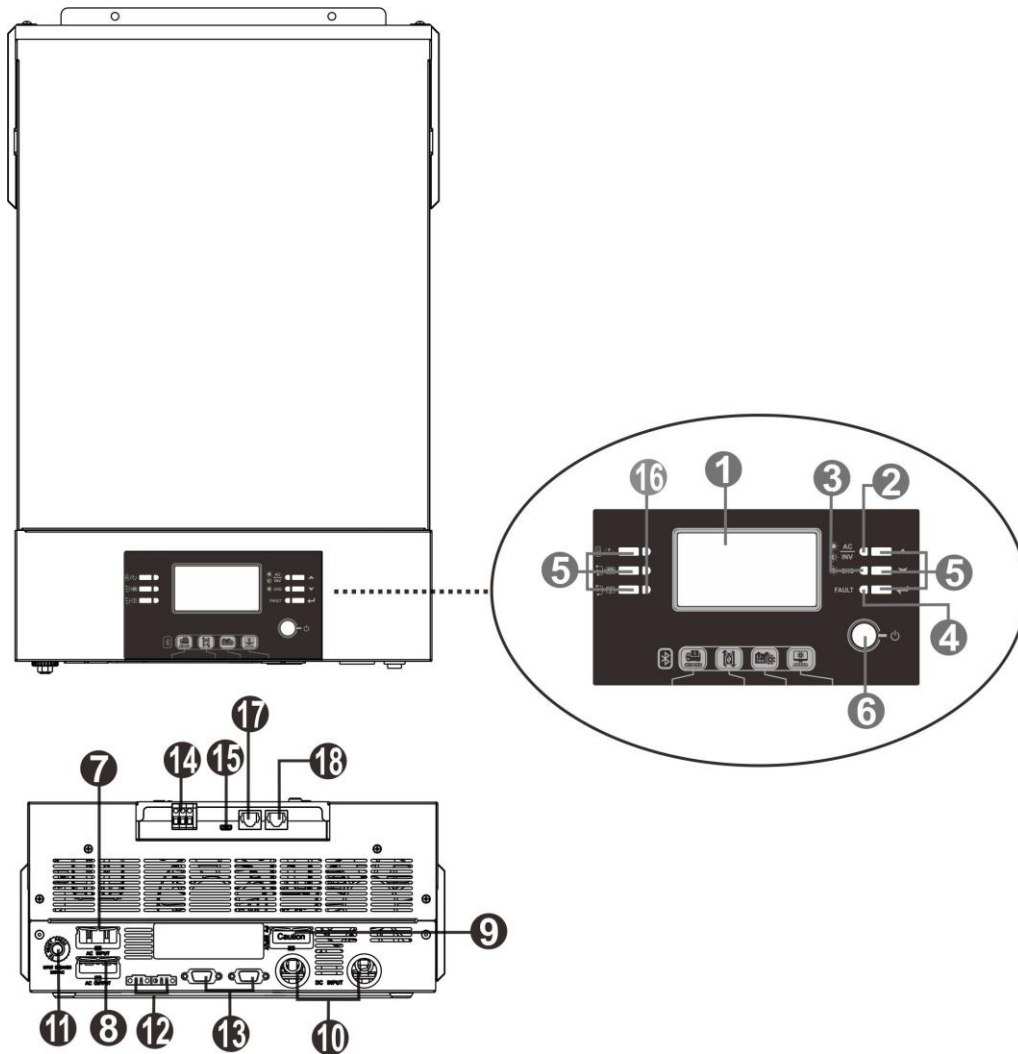

**NOTE:** For parallel model installation and operation, please check separate parallel installation guide for the details.

1. LCD display
2. Status indicator
3. Charging indicator
4. Fault indicator
5. Function buttons
6. Power on/off switch
7. AC input connectors
8. AC output connectors (Load connection)
9. PV connectors
10. Battery connectors
11. Circuit breaker
12. Current sharing port
13. Parallel communication port
14. Dry contact
15. USB port: for communication port and USB function port
16. LED indicators for USB function setting
17. BMS communication port: CAN, RS-485 or RS-232
18. RS-232 communication port

# INSTALLATION

## Unpacking and Inspection

Before installation, please inspect the unit. Be sure that nothing inside the package is damaged. You should have received the following items inside of package:

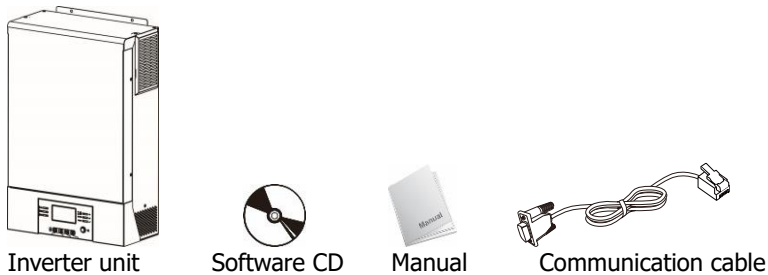

## Preparation

Before connecting all wirings, please take off bottom cover by removing two screws as shown below.

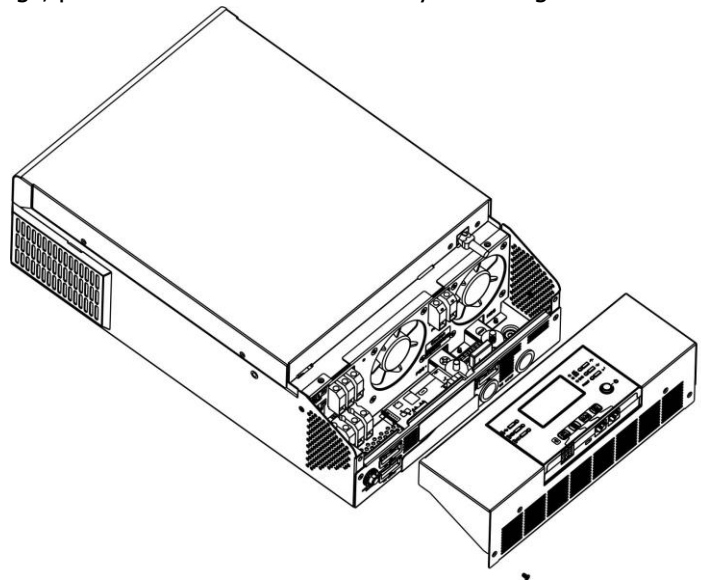

## Mounting the Unit

Consider the following points before selecting where to install:

- Do not mount the inverter on flammable construction materials.
- Mount on a solid surface
- Install this inverter at eye level in order to allow the LCD display to be read at all times.
- The ambient temperature should be between 0°C and 55°C to ensure optimal operation.
- The recommended installation position is to be adhered to the wall vertically.
- Be sure to keep other objects and surfaces as shown in the right diagram to guarantee sufficient heat dissipation and to have enough space for removing wires.

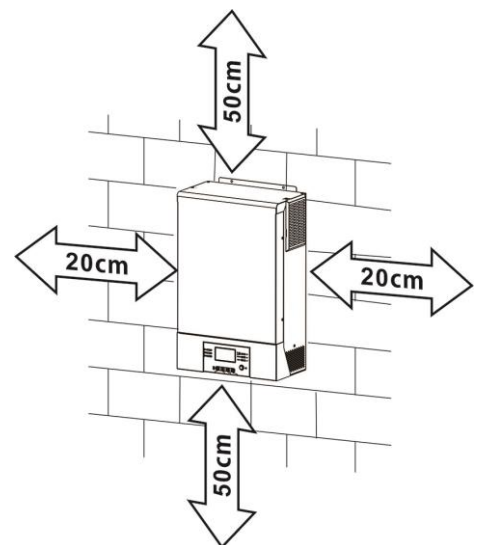

**SUITABLE FOR MOUNTING ON CONCRETE OR OTHER NON-COMBUSTIBLE SURFACE ONLY.**

Install the unit by screwing three screws. It's recommended to use M4 or M5 screws.

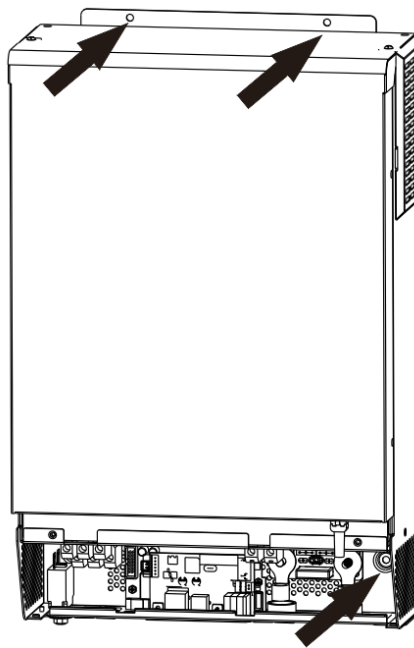

## Battery Connection

**CAUTION:** For safety operation and regulation compliance, it's requested to install a separate DC over-current protector or disconnect device between battery and inverter. It may not be required to have a disconnect device in some applications, however, it's still required to have over-current protection installed. Please refer to typical amperage in below table as required fuse or breaker size.

**WARNING!** All wiring must be performed by a qualified personnel.

**WARNING!** It's very important for system safety and efficient operation to use appropriate cable for battery connection. To reduce risk of injury, please use the proper recommended cable and terminal size as below.

**Ring terminal:**

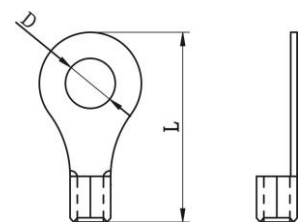

**Recommended battery cable and terminal size:**

Model	Typical Amperage	Battery Capacity	Wire Size	Ring Terminal			Torque Value
				Cable mm <sup>2</sup>	Dimensions		
					D (mm)	L (mm)	
5KW	135A	200AH	2*4AWG	44	6.4	49.7	2~3 Nm

Please follow below steps to implement battery connection:

1. Assemble battery ring terminal based on recommended battery cable and terminal size.
2. Insert the ring terminal of battery cable flatly into battery connector of inverter and make sure the nuts are tightened with torque of 2-3 Nm. Make sure polarity at both the battery and the inverter/charge is correctly connected and ring terminals are tightly screwed to the battery terminals.

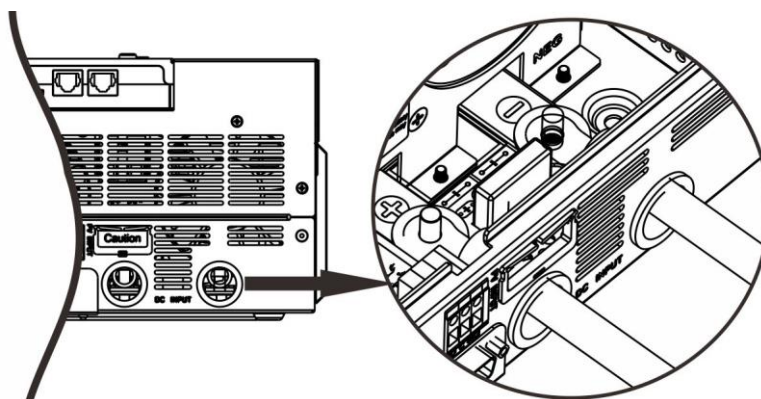

**WARNING: Shock Hazard**

Installation must be performed with care due to high battery voltage in series.



**CAUTION!!** Do not place anything between the flat part of the inverter terminal and the ring terminal. Otherwise, overheating may occur.

**CAUTION!!** Do not apply anti-oxidant substance on the terminals before terminals are connected tightly.

**CAUTION!!** Before making the final DC connection or closing DC breaker/disconnector, be sure positive (+) must be connected to positive (+) and negative (-) must be connected to negative (-).

## AC Input/Output Connection

**CAUTION!!** Before connecting to AC input power source, please install a **separate** AC breaker between inverter and AC input power source. This will ensure the inverter can be securely disconnected during maintenance and fully protected from over current of AC input.

**CAUTION!!** There are two terminal blocks with "IN" and "OUT" markings. ENSURE that utility AC input is connected to IN and load AC to OUT and not the wrong way round and also that Line and Neutrals are connected correctly.

**WARNING!** All wiring must be performed by a qualified personnel.

**WARNING!** It's very important for system safety and efficient operation to use appropriate cable for AC input connection. To reduce risk of injury, please use the proper recommended cable size as below.

### Suggested cable requirement for AC wires

Model	Gauge	Torque Value
5KW	10 AWG	1.2~ 1.6 Nm

Please follow below steps to implement AC input/output connection:

1. Before making AC input/output connection, be sure to open DC protector or disconnector first.
2. Remove insulation sleeve 10mm for six conductors. And shorten phase L and neutral conductor N 3 mm.
3. Insert AC input wires according to polarities indicated on terminal block and tighten the terminal screws. Be sure to connect PE protective conductor (⊕) first.

⊕ → **Ground (yellow-green)**

L → **LINE (brown or black)**

N → **Neutral (blue)**

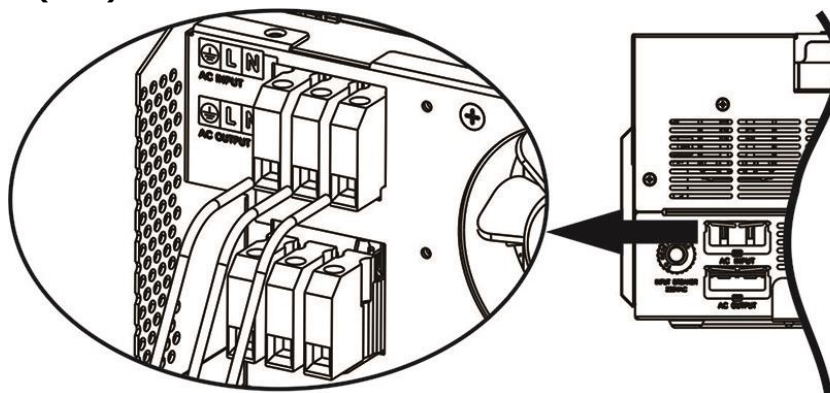
**WARNING:**

Be sure that AC power source is disconnected before attempting to hardwire it to the unit.

4. Then, insert AC output wires according to polarities indicated on terminal block and tighten terminal screws.



Be sure to connect PE protective conductor (⊕) first.

⊕ → **Ground (yellow-green)**

**L** → **LINE (brown or black)**

**N** → **Neutral (blue)**

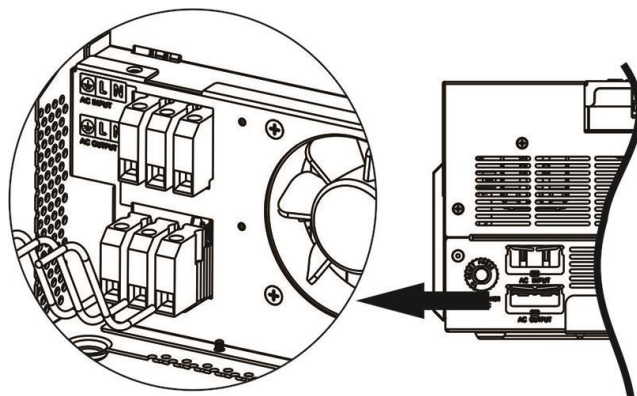

5. Make sure the wires are securely connected.

**CAUTION: Important**

Be sure to connect AC wires with correct polarity. If L and N wires are connected reversely, it may cause utility short-circuited when these inverters are worked in parallel operation.

**CAUTION:** Appliances such as air conditioner are required at least 2~3 minutes to restart because it's required to have enough time to balance refrigerant gas inside of circuits. If a power shortage occurs and recovers in a short time, it will cause damage to your connected appliances. To prevent this kind of damage, please check manufacturer of air conditioner if it's equipped with time-delay function before installation. Otherwise, this inverter/charger will trig overload fault and cut off output to protect your appliance but sometimes it still causes internal damage to the air conditioner.

**PV Connection**

**CAUTION:** Before connecting to PV modules, please install **separately** a DC circuit breaker between inverter and PV modules.

**CAUTION:** Please install a surge protection device between inverter and PV modules and the recommended voltage is 500V.

**WARNING!** Do switch off the inverter before connecting to PV modules. Otherwise, it will cause inverter damage.

**WARNING!** Do NOT connect negative and positive terminal of PV modules to the ground.

**WARNING!** All wiring must be performed by a qualified personnel.

**WARNING!** It's very important for system safety and efficient operation to use appropriate cable for PV module connection. To reduce risk of injury, please use the proper recommended cable size as below.

Model	Typical Amperage	Cable Size	Torque
5KW	18A	12AWG	1.2~1.6Nm

**PV Module Selection:**

When selecting proper PV modules, please be sure to consider below parameters:

1. Open circuit Voltage (Voc) of PV modules not exceeds max. PV array open circuit voltage of inverter.
2. Open circuit Voltage (Voc) of PV modules should be higher than min. battery voltage.

Solar Charging Mode	
<b>INVERTER MODEL</b>	<b>5KW</b>
Max. PV Array Open Circuit Voltage	450 Vdc
PV Array MPPT Voltage Range	120~430Vdc
MPP Number	1

Please follow below steps to implement PV module connection:

1. Remove insulation sleeve 10 mm for positive and negative conductors.
2. Check correct polarity of connection cable from PV modules and PV input connectors. Then, connect positive pole (+) of connection cable to positive pole (+) of PV input connector. Connect negative pole (-) of connection cable to negative pole (-) of PV input connector.

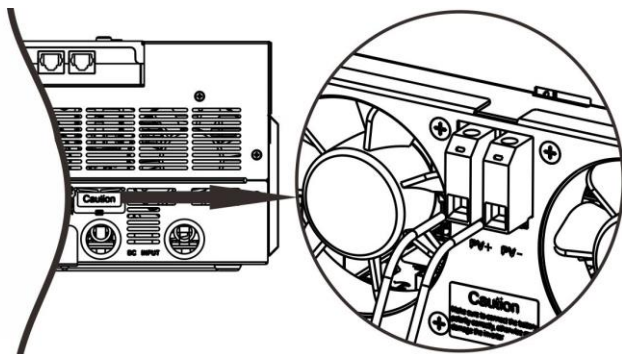
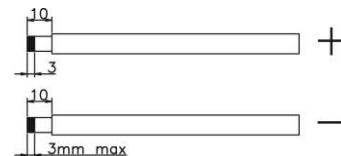

### Recommended PV module Configuration

PV Module Spec. (reference)	Total solar input power	Solar input	Q'ty of modules
- 250Wp - Vmp: 30.7Vdc - Imp: 8.15A - Voc: 37.4Vdc - Isc: 8.63A - Cells: 60	1500W	6 pieces in series	6 pcs
	2000W	8 pieces in series	8 pcs
	2750W	11 pieces in series	11 pcs
	3000W	6 pieces in series 2 strings in parallel	12 pcs
	4000W	8 pieces in series 2 strings in parallel	16 pcs
	5000W	10 pieces in series 2 strings in parallel	20 pcs

### Final Assembly

After connecting all wirings, please put bottom cover back by screwing two screws as shown below.

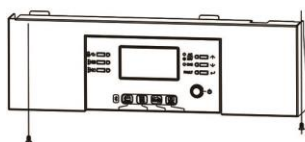
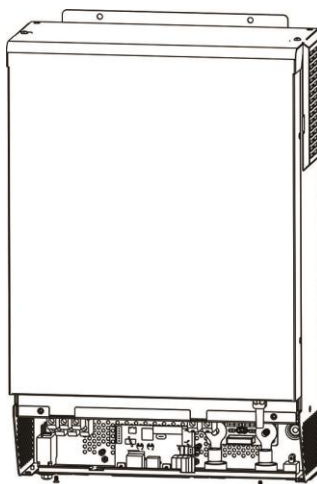

# Communication Connection

## Serial Connection

Please use supplied communication cable to connect to inverter and PC. Insert bundled CD into a computer and follow on-screen instruction to install the monitoring software. For the detailed software operation, please check user manual of software inside of CD.

## Bluetooth Connection

This unit is equipped with a Bluetooth transmitter. Download "WatchPower" APP from Google Play or Google Store. Once the APP is download, you may connect "WatchPower" APP to your inverter with the password "123456". The communication distance is roughly 6 ~ 7 meters.



## Dry Contact Signal

There is one dry contact (3A/250VAC) available on the bottom of the display panel. It could be used to deliver signal to external device when battery voltage reaches warning level.

Unit Status	Condition		Dry contact port: 		
			NC & C	NO & C	
Power Off	Unit is off and no output is powered.		Close	Open	
Power On	Output is powered from Utility.		Close	Open	
	Output is powered from Battery or Solar.	Program 01 set as SUB or USB	Battery voltage < Low DC warning voltage	Open	Close
			Battery voltage > Setting value in Program 13 or battery charging reaches floating stage	Close	Open
	Output is powered from Battery or Solar.	Program 01 is set as SbU	Battery voltage < Setting value in Program 12	Open	Close
Battery voltage > Setting value in Program 13 or battery charging reaches floating stage			Close	Open	

# OPERATION

## Power ON/OFF

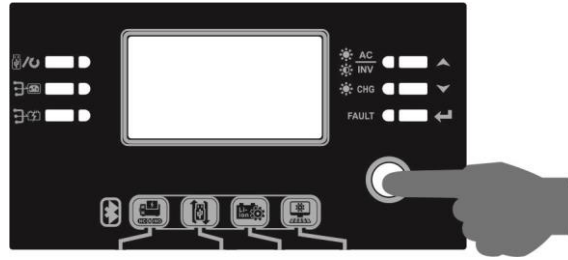

Once the unit has been properly installed and the batteries are connected well, simply press On/Off switch (located on the display panel) to turn on the unit.

## Operation and Display Panel



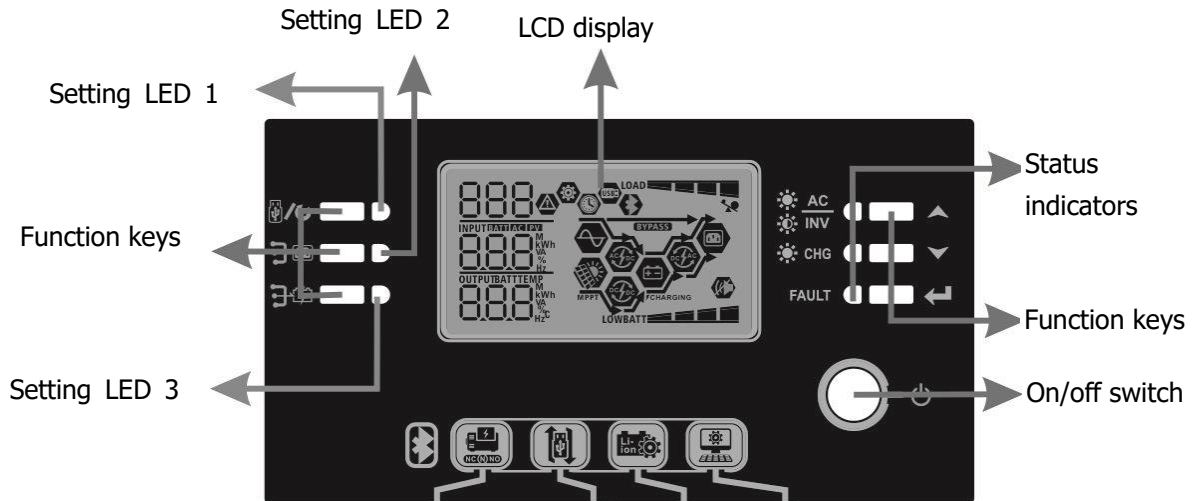

The operation and display panel, shown in below chart, is on the front panel of the inverter. It includes six indicators, six function keys, on/off switch and a LCD display, indicating the operating status and input/output power information.



### Indicators







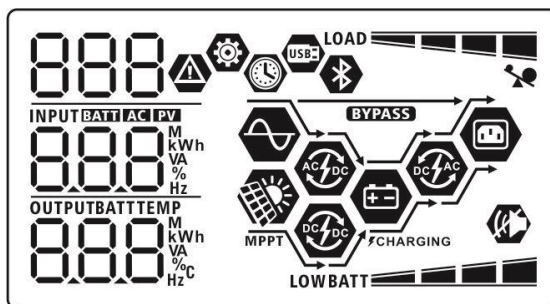

LED Indicator	Color	Solid/Flashing	Messages
<b>Setting LED 1</b>	Green	Solid On	Output powered by utility
<b>Setting LED 2</b>	Green	Solid On	Output powered by PV
<b>Setting LED 3</b>	Green	Solid On	Output powered by battery
<b>Status indicators</b>		Solid On	Output is available in bypass mode
		Flashing	Output is powered by battery in inverter mode
		Solid On	Battery is fully charged
		Flashing	Battery is charging.
<b>FAULT</b>	Red	Solid On	Fault mode
		Flashing	Warning mode

## Function Keys

Function Key	Description	
	ESC	Exit setting mode
	USB function setting	Select USB OTG functions
	Up	To last selection
	Down	To next selection
	Enter	To confirm the selection in setting mode or enter setting mode

## LCD Display Icons



Icon	Function description	
<b>Input Source Information</b>		
	Indicates the AC input.	
	Indicates the PV input	
	Indicate input voltage, input frequency, PV voltage, charger current, charger power, battery voltage.	
<b>Configuration Program and Fault Information</b>		
	Indicates the setting programs.	
	Indicates the warning and fault codes. Warning:  flashing with warning code. Fault:  lighting with fault code	
<b>Output Information</b>		
	Indicate output voltage, output frequency, load percent, load in VA, load in Watt and discharging current.	
<b>Battery Information</b>		
	Indicates battery level by 0-24%, 25-49%, 50-74% and 75-100% in battery mode and charging status in line mode.	
In AC mode, it will present battery charging status.		
Status	Battery voltage	LCD Display
Constant Current mode / Constant Voltage mode	<2V/cell	4 bars will flash in turns.
	2 ~ 2.083V/cell	Bottom bar will be on and the other three bars will flash in turns.
	2.083 ~ 2.167V/cell	Bottom two bars will be on and the other two bars will flash in turns.
	> 2.167 V/cell	Bottom three bars will be on and the top bar will flash.
Floating mode. Batteries are fully charged.		4 bars will be on.

In battery mode, it will present battery capacity.

Load Percentage	Battery Voltage	LCD Display
Load > 50%	< 1.85V/cell	<b>LOWBATT</b>
	1.85V/cell ~ 1.933V/cell	<b>BATT</b>
	1.933V/cell ~ 2.017V/cell	<b>BATT</b>
	> 2.017V/cell	<b>BATT</b>
Load < 50%	< 1.892V/cell	<b>LOWBATT</b>
	1.892V/cell ~ 1.975V/cell	<b>BATT</b>
	1.975V/cell ~ 2.058V/cell	<b>BATT</b>
	> 2.058V/cell	<b>BATT</b>

### Load Information

	Indicates overload.	
 	Indicates the load level by 0-24%, 25-49%, 50-74% and 75-100%.	
	0%~24%	25%~49%
	<b>LOAD</b>	<b>LOAD</b>
	50%~74%	75%~100%
	<b>LOAD</b>	<b>LOAD</b>

### Mode Operation Information





	Indicates unit connects to the mains.
	Indicates unit connects to the PV panel.
<b>BYPASS</b>	Indicates load is supplied by utility power.
	Indicates the utility charger circuit is working.
	Indicates the solar charger circuit is working.
	Indicates the DC/AC inverter circuit is working.
	Indicates unit alarm is disabled.
	Indicates Bluetooth is connected.
	Indicates USB disk is connected.
	Indicates timer setting or time display









# LCD Setting

## General Setting











After pressing and holding “←” button for 3 seconds, the unit will enter setting mode. Press “▲” or “▼” button to select setting programs. And then, press “←” button to confirm the selection or “☰/↺” button to exit.













### Setting Programs:







Program	Description	Selectable option	
00	Exit setting mode	Escape 00  ESC	
01	Output source priority: To configure load power source priority	Utility first (Default) 01  USb	Utility will provide power to the loads as first priority. Solar and battery energy will provide power to the loads only when utility power is not available.
		Solar first 01  SUB	Solar energy provides power to the loads as first priority. If solar energy is not sufficient to power all connected loads, utility power will supply power the loads with solar at the same time. Battery energy provides power to the loads only when solar energy and utility power are not available.
		SBU priority 01  SbU	Solar energy provides power to the loads as first priority. If solar energy is not sufficient to power all connected loads, battery energy will supply power to the loads at the same time. Utility provides power to the loads only when battery voltage drops to either low-level warning voltage or the setting point in program 12.
02	Maximum charging current: To configure total charging current for solar and utility chargers. (Max. charging current = utility charging current + solar charging current)	60A (Default) 02  60 <sup>A</sup>	Setting range is from 10A to 100A and increment of each click is 10A.









03	AC input voltage range	Appliances (Default) 03 	If selected, acceptable AC input voltage range will be within 90-280VAC.
		APL	
04	Power saving mode enable/disable	UPS 03 	If selected, acceptable AC input voltage range will be within 170-280VAC.
		UPS	
04	Power saving mode enable/disable	Saving mode disable (default) 04 	If disabled, no matter connected load is low or high, the on/off status of inverter output will not be effected.
		SdS	
04	Power saving mode enable/disable	Saving mode enable 04 	If enabled, the output of inverter will be off when connected load is pretty low or not detected.
		SEN	
05	Battery type	AGM (Default) 05 	Flooded 05 
		AGn	FLd
		User-Defined 05 	If "User-Defined" is selected, battery charge voltage and low DC cut-off voltage can be set up in program 26, 27 and 29.
		USE	
05	Battery type	Pylontech battery 05 	If selected, programs of 02, 26, 27 and 29 will be automatically set up. No need for further setting.
		PYL	
05	Battery type	WECO battery 05 	If selected, programs of 02, 12, 26, 27 and 29 will be auto-configured per battery supplier recommended. No need for further adjustment.
		WEC	























5	Battery type	Soltaro battery 05  SOL	If selected, programs of 02, 26, 27 and 29 will be automatically set up. No need for further setting.
		BAK battery 05  BAK	If selected, programs of 02, 26, 27 and 29 will be automatically set up. No need for further setting.
		LIb-protocol compatible battery 05  LIb	Select " LIb" if using Lithium battery compatible to Lib protocol. If selected, programs of 02, 26, 27 and 29 will be automatically set up. No need for further setting.
		3 <sup>rd</sup> party Lithium battery 05  LIC	If selected, programs of 02, 26, 27 and 29 will be automatically set up. No need for further setting. Please contact the battery supplier for installation procedure.
06	Auto restart when overload occurs	Restart disable (Default) 06  LFD	Restart enable 06  LFE
07	Auto restart when over temperature occurs	Restart disable (Default) 07  tFd	Restart enable 07  tFE
08	Output voltage	220V 08  220 <sub>v</sub>	230V (default) 08  230 <sub>v</sub>
		240V 08  240 <sub>v</sub>	

09	Output frequency	50Hz (Default) 09  50 <sub>Hz</sub>	60Hz 09  60 <sub>Hz</sub>
11	Maximum utility charging current  Note: If setting value in program 02 is smaller than that in program in 11, the inverter will apply charging current from program 02 for utility charger.	2A 11  2 <sup>A</sup>	10A 11  10 <sup>A</sup>
		20A 11  20 <sup>A</sup>	30A (Default) 11  30 <sup>A</sup>
		40A 11  40 <sup>A</sup>	50A 11  50 <sup>A</sup>
		60A 11  60 <sup>A</sup>	70A 11  70 <sup>A</sup>
		80A 11  80 <sup>A</sup>	90A 11  90 <sup>A</sup>
		100A 11  100 <sup>A</sup>	









12	Setting voltage point back to utility source when selecting "SBU" (SBU priority) or "SUB" (solar first) in program 01.	default setting: 46V 	Setting range is from 44V to 57V and increment of each click is 1V.
		5% (default) 	If "WECO battery" is selected in program 05, the setting value will be fixed at 5% of connected battery capacity.
13	Setting voltage point back to battery mode when selecting "SBU" (SBU priority) or "SUB" (solar first) in program 01.	Battery fully charged 	The setting range is from 48V to 64V and increment of each click is 1V.
		default setting: 54V 	
		10% (default) 	
16	Charger source priority: To configure charger source priority	If this inverter/charger is working in Line, Standby or Fault mode, charger source can be programmed as below:  Solar first   Utility first 	Solar energy will charge battery as first priority. Utility will charge battery only when solar energy is not available.  Utility will charge battery as first priority. Solar energy will charge battery only when utility power is not available.

		Solar and Utility (Default) 16   SNU	Solar energy and utility will charge battery at the same time.
		Only Solar 16   OSO	Solar energy will be the only charger source no matter utility is available or not.
		If this inverter/charger is working in Battery mode or Power saving mode, only solar energy can charge battery. Solar energy will charge battery if it's available and sufficient.	
18	Alarm control	Alarm on (Default) 18   60N	Alarm off 18   60F
19	Auto return to default display screen	Return to default display screen (Default) 19   ESP	If selected, no matter how users switch display screen, it will automatically return to default display screen (Input voltage /output voltage) after no button is pressed for 1 minute.
		Stay at latest screen 19   LEP	If selected, the display screen will stay at latest screen user finally switches.
20	Backlight control	Backlight on (Default) 20   LON	Backlight off 20   LOF

22	Beeps while primary source is interrupted	Alarm on (Default) 22  A0n	Alarm off 22  A0F
23	Overload bypass: When enabled, the unit will transfer to line mode if overload occurs in battery mode.	Bypass disable (Default) 23  bYd	Bypass enable 23  bYE
25	Record Fault code	Record enable 25  FEN	Record disable (Default) 25  FdS
26	Bulk charging voltage (C.V voltage)	default setting: 56.4V 26  CV BATT 56.4 <sub>v</sub>	If self-defined is selected in program 5, this program can be set up. Setting range is from 48.0V to 64.0V. Increment of each click is 0.1V.
27	Floating charging voltage	default setting: 54.0V 27  FLV BATT 54.0 <sub>v</sub>	If self-defined is selected in program 5, this program can be set up. Setting range is from 48.0V to 64.0V. Increment of each click is 0.1V.
28	AC output mode *This setting is able to set up only when the inverter is in standby mode, Be sure that on/off Switch is in "OFF" status.	Single: This inverter is used in single phase application. 28  S10	Parallel: This inverter is operated in parallel system. 28  PAR
		L1 phase: 28  3P1	L2 phase: 28  3P2



		L3 phase: 28   3P3	
29	Low DC cut-off voltage	default setting: 42.0V 29  CO4 BATT 42.0V	If self-defined is selected in program 5, this program can be set up. Setting range is from 40.0V to 54.0V. Increment of each click is 0.1V. Low DC cut-off voltage will be fixed to setting value no matter what percentage of load is connected.
32	Bulk charging time (C.V stage)	Automatically (Default): 32   AUT	If selected, inverter will judge this charging time automatically.
		5 min 32   5	The setting range is from 5 min to 900 min. Increment of each click is 5 min.
		900 min 32   900	
33	Battery equalization	Battery equalization 33   EEN	Battery equalization disable (Default) 33   Ed5
		If "Flooded" or "User-Defined" is selected in program 05, this program can be set up.	
34	Battery equalization voltage	Default setting is 58.4V. 34  EV BATT 58.4V	Setting range is from 48V ~ 64V. Increment of each click is 0.1V.

35	Battery equalized time	60min (Default) 35 ⚙️ 60	Setting range is from 5min to 900min. Increment of each click is 5min.
36	Battery equalized timeout	120min (Default) 36 ⚙️ 120	Setting range is from 5min to 900 min. Increment of each click is 5 min.
37	Equalization interval	30days (Default) 37 ⚙️ 30d	Setting range is from 0 to 90 days. Increment of each click is 1 day
39	Equalization activated immediately	Enable 39 ⚙️ REN	Disable (Default) 39 ⚙️ RdS
<p>If equalization function is enabled in program 33, this program can be set up. If "Enable" is selected in this program, it's to activate battery equalization immediately and LCD main page will shows "E9". If "Disable" is selected, it will cancel equalization function until next activated equalization time arrives based on program 37 setting. At this time, "E9" will not be shown in LCD main page.</p>			
40	Reset all stored data for PV generated power and output load energy	Not reset (Default) 40 ⚙️ Nrt	Reset 40 ⚙️ rSt
93	Erase all data log	Not reset(Default) 93 ⚙️ Nrt	Reset 93 ⚙️ rSt
94	Data log recorded interval *The maximum data log number is 1440. If it's over 1440, it will re-write the first log.	3 days 94 ⚙️ 3	5 days 94 ⚙️ 5



		10 days (Default) 94   10	20 days 94   20
		30 days 94   30	60 days 94   60
95	Time setting – Minute	95  mi n 0	For minute setting, the range is from 00 to 59.
96	Time setting – Hour	96  HOU 0	For hour setting, the range is from 00 to 23.
97	Time setting– Day	97  DAY 1	For day setting, the range is from 00 to 31.
98	Time setting– Month	98  MON 1	For month setting, the range is from 01 to 12.
99	Time setting – Year	99  YEA 19	For year setting, the range is from 17 to 99.

## USB Functional Setting







There are three function keys on the display panel to implement USB OTG setting.

Insert an OTG USB disk into the USB port (). Press and hold "/U" button for 3 seconds to enter USB Setting Mode. These functions including inverter firmware upgrade, data log export and internal parameters re-write from the USB disk.



<b>Procedure</b>	LCD Screen
<b>Step 1:</b> Press and hold "UPG" button for 3 seconds to enter USB function setting mode.	UPG  
<b>Step 2:</b> Press "UPG", "SET" or "LOG" button to enter the selectable setting programs (detail descriptions in Step 3).	SET LOG

**Step 3:** Please select setting program by following the procedure.

Program #	Operation Procedure	LCD Screen
 : Upgrade firmware	This function is to upgrade inverter firmware. If firmware upgrade is needed, please check with your dealer or installer for detail instructions.	
 : Re-write internal parameters	This function is to over-write all parameter settings (TEXT file) with settings in the On-The-Go USB disk from a previous setup or to duplicate inverter settings. Please check with your dealer or installer for detail instructions.	
 : Export data log	Press "LOG" button to export data log from the inverter to USB disk. If the selected function is ready, LCD will display "LDY". Press "UPG" button to confirm the selection again.	LOG    LDY
	<ul style="list-style-type: none"> <li>Press "SET" button to select "Yes", LED 1 will flash once every second during the process. It will only display LOG and all LEDs will be on after this action is complete. Then, press "UPG" button to return to main screen.</li> <li>Or press "LOG" button to select "No" to return to main screen.</li> </ul>	LOG   YES NO

If no button is pressed for 1 minute, it will automatically return to main screen.

**Error message for USB On-The-Go functions:**

Error Code	Messages
U01	No USB disk is detected.
U02	USB disk is protected from copying.
U03	Document inside the USB disk contains the wrong format.

If any error occurs, error code will only show for 3 seconds. After 3 seconds, it will automatically return to the main screen.

## Display Setting

The LCD display information will be switched in turns by pressing “▲” or “▼” key. The selectable information is switched as the following table in order.

Selectable information	LCD display
Input voltage/Output voltage (Default Display Screen)	<p>Input Voltage=230V, output voltage=230V</p>
Input frequency	<p>Input frequency=50Hz</p>
PV voltage	<p>PV voltage=260V</p>
PV current	<p>PV current = 2.5A</p>
PV power	<p>PV power = 500W</p>

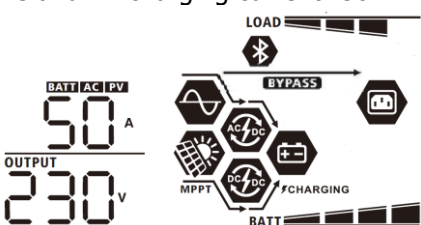
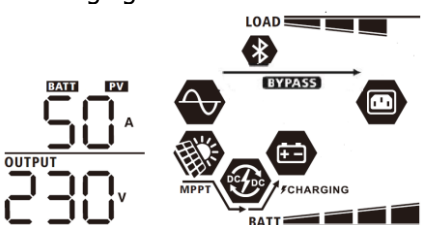
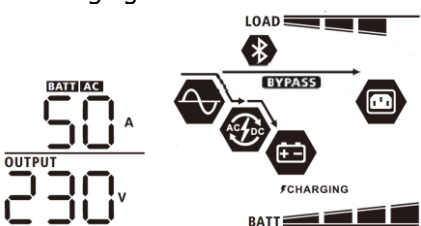
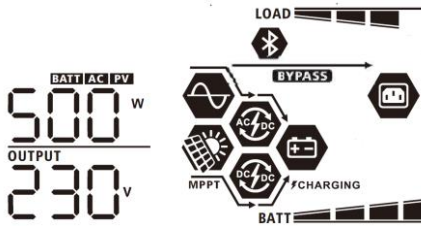
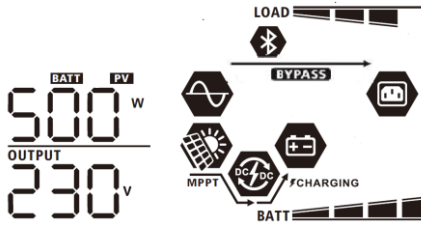
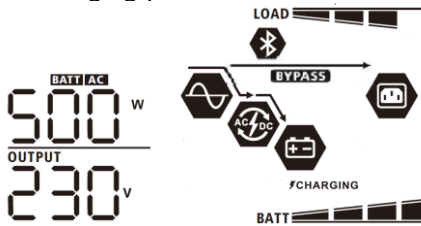
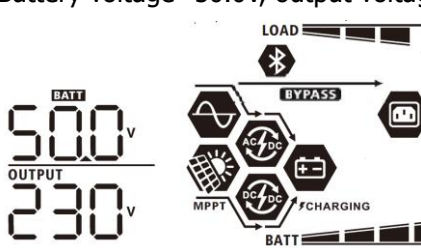

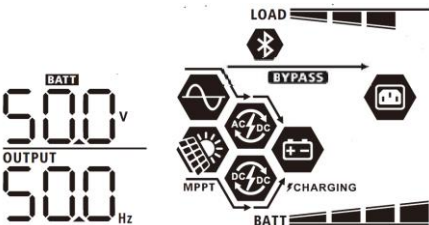
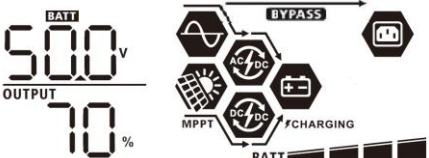
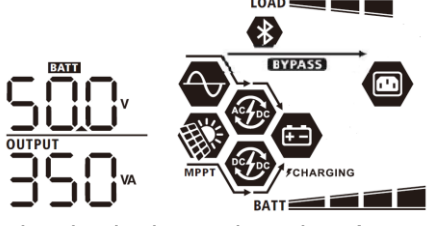
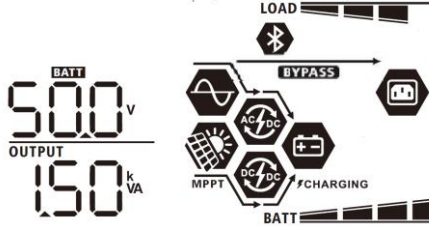
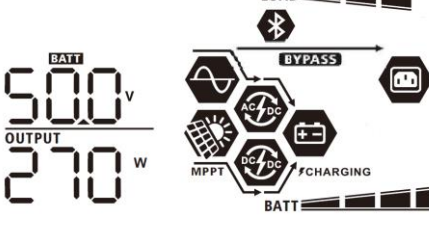
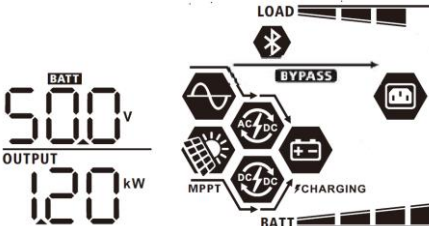
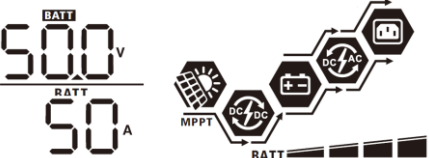

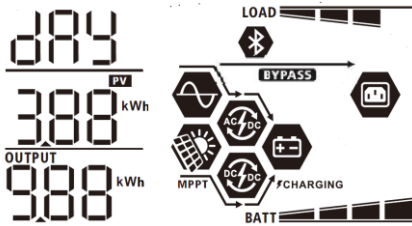
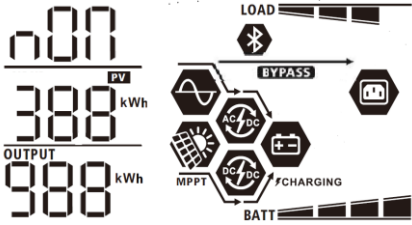
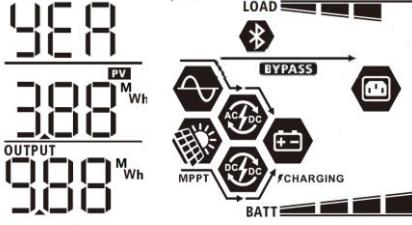
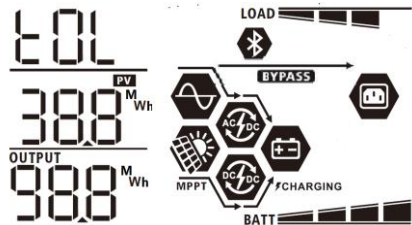
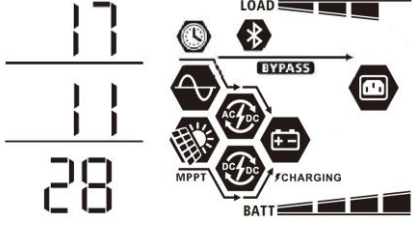
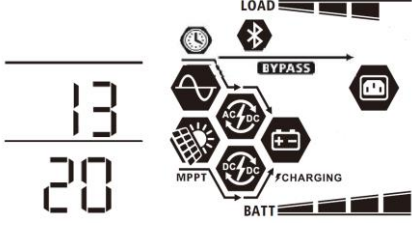
<p>Charging current</p>	<p>AC and PV charging current=50A</p>  <p>PV charging current=50A</p>  <p>AC charging current=50A</p> 
<p>Charging power</p>	<p>AC and PV charging power=500W</p>  <p>PV charging power=500W</p>  <p>AC charging power=500W</p> 
<p>Battery voltage and output voltage</p>	<p>Battery voltage=50.0V, output voltage=230V</p> 

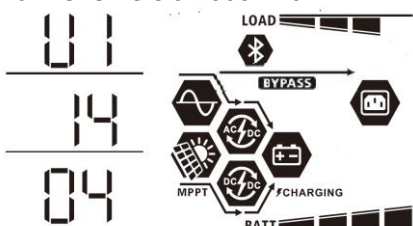
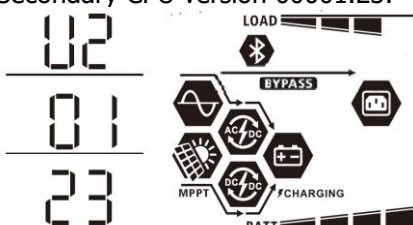
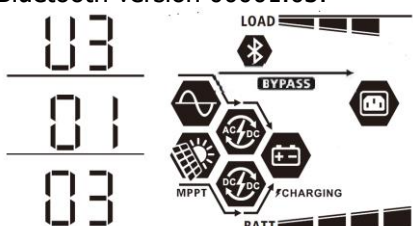



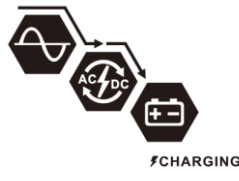

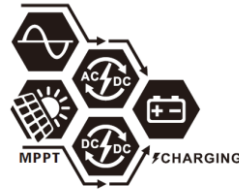
Output frequency	<p>Output frequency=50Hz</p> 
Load percentage	<p>Load percent=70%</p> 
Load in VA	<p>When connected load is lower than 1kVA, load in VA will present xxxVA like below chart.</p>  <p>When load is larger than 1kVA (<math>\geq 1\text{kVA}</math>), load in VA will present x.xkVA like below chart.</p> 
Load in Watt	<p>When load is lower than 1kW, load in W will present xxxW like below chart.</p>  <p>When load is larger than 1kW (<math>\geq 1\text{kW}</math>), load in W will present x.xkW like below chart.</p> 
Battery voltage/DC discharging current	<p>Battery voltage=50.0V, discharging current=50A</p> 

<p>PV energy generated today and Load output energy today</p>	<p>PV energy generated Today = 3.88kWh, Load output energy Today = 9.88kWh.</p> 
<p>PV energy generated this month and Load output energy this month.</p>	<p>PV energy generated this month = 388kWh, Load output energy this month = 988kWh.</p> 
<p>PV energy generated this year and Load output energy this year.</p>	<p>PV energy generated this year energy = 3.88MWh, Load output energy this year = 9.88MWh.</p> 
<p>PV energy generated totally and Load output total energy.</p>	<p>Total PV energy until now= 38.8MWh, Total load output energy until now= 98.8MWh.</p> 
<p>Real date.</p>	<p>Real date Nov 28, 2017.</p> 
<p>Real time.</p>	<p>Real time 13:20.</p> 

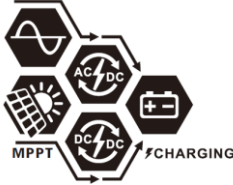
Main CPU version checking.	<p>Main CPU version 00014.04.</p> 
Secondary CPU version checking.	<p>Secondary CPU version 00001.23.</p> 
Bluetooth version checking.	<p>Bluetooth version 00001.03.</p> 

## Operating Mode Description

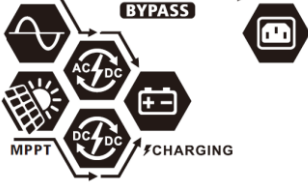
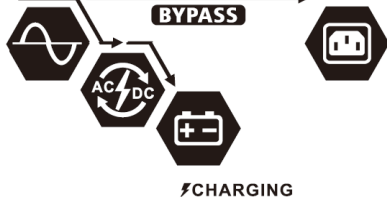
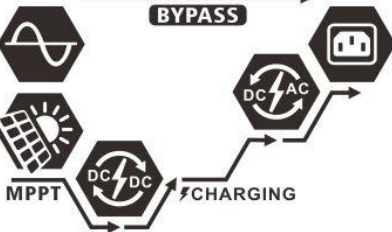
Operating mode	Behaviors	LCD display
<p>Standby mode / Power saving mode</p> <p><b>Note:</b></p> <p>*Standby mode: The inverter is not turned on yet but at this time, the inverter can charge battery without AC output.</p> <p>*Power saving mode: If enabled, the output of inverter will be off when connected load is pretty low or not detected.</p>	<p>No output is supplied by the unit but it still can charge batteries.</p>	<p>Battery is charged by utility.</p> 
		<p>Battery is charged by PV energy.</p> 
		<p>Battery is charged by utility and PV energy.</p> 
		<p>No charging.</p> 

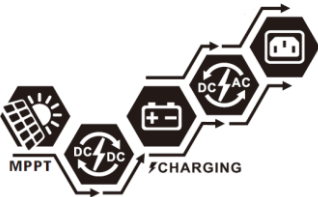
<p>Fault mode</p> <p>Note:</p> <p>*Fault mode: Errors are caused by inside circuit error or external reasons such as over temperature, output short circuited and so on.</p>	<p>PV energy and utility can charge batteries.</p>	<p>Charging by utility and PV energy.</p>  <p>Charging by utility.</p>  <p>Charging by PV energy.</p>  <p>No charging.</p> 
<p>Line mode</p>	<p>Output power from utility. Charger is available.</p>	<p>Charging by utility and PV energy.</p>  <p>Charging by utility.</p>  <p>Battery is not connected, solar energy and the utility will provide the loads.</p> 
	<p>Output power from utility. Charger is available.</p>	<p>Power from utility.</p> 
<p>Battery mode</p>	<p>Output power from battery or PV</p>	<p>Power from battery and PV energy.</p> 

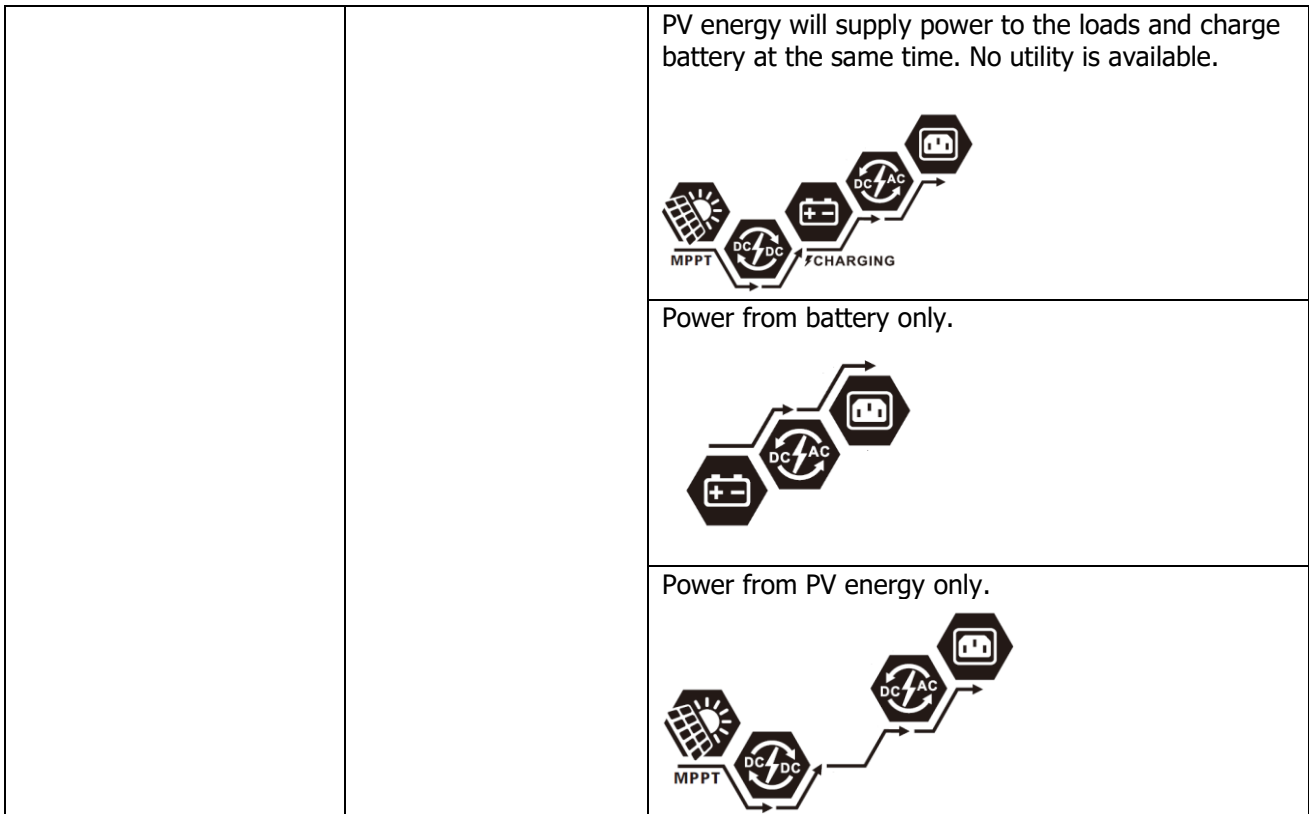











## Faults Reference Code

Fault Code	Fault Event	Icon on
01	Fan is locked when inverter is off.	F01
02	Over temperature	F02
03	Battery voltage is too high	F03
04	Battery voltage is too low	F04
05	Output short circuited or over temperature is detected by internal converter components.	F05
06	Output voltage is too high.	F06
07	Overload time out	F07
08	Bus voltage is too high	F08
09	Bus soft start failed	F09
10	PV over current	F10
11	PV over voltage	F11
12	DCDC over current	F12
51	Over current or surge	F51
52	Bus voltage is too low	F52
53	Inverter soft start failed	F53
55	Over DC voltage in AC output	F55
57	Battery connection is open	F57
58	Current sensor failed	F58



## Warning Indicator

Warning Code	Warning Event	Audible Alarm	Icon flashing
01	Fan is locked when inverter is on.	Beep three times every second	01 
02	Over temperature	None	02 
03	Battery is over-charged	Beep once every second	03 
04	Low battery	Beep once every second	04 
07	Overload	Beep once every 0.5 second	07  
10	Output power derating	Beep twice every 3 seconds	10 
32	Communication interrupted	None	32 
Eq	Battery equalization	None	E9 
bP	Battery is not connected	None	bP 

## BATTERY EQUALIZATION

Equalization function is added into charge controller. It reverses the buildup of negative chemical effects like stratification, a condition where acid concentration is greater at the bottom of the battery than at the top. Equalization also helps to remove sulfate crystals that might have built up on the plates. If left unchecked, this condition, called sulfation, will reduce the overall capacity of the battery. Therefore, it's recommended to equalize battery periodically.

### ● How to Apply Equalization Function

You must enable battery equalization function in monitoring LCD setting program 33 first. Then, you may apply this function in device by either one of following methods:

1. Setting equalization interval in program 37.
2. Active equalization immediately in program 39.

### ● When to Equalize

In float stage, when the setting equalization interval (battery equalization cycle) is arrived, or equalization is active immediately, the controller will start to enter Equalize stage.

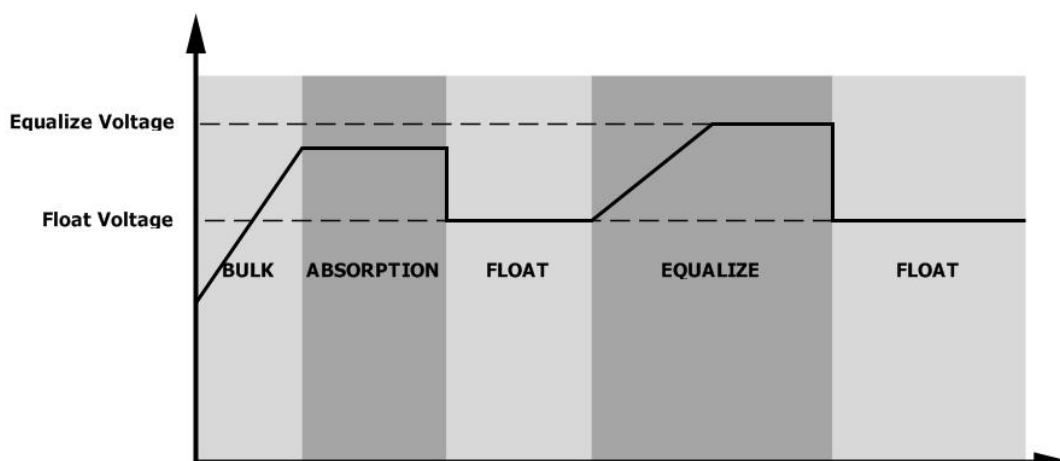

- **Equalize charging time and timeout**

In Equalize stage, the controller will supply power to charge battery as much as possible until battery voltage raises to battery equalization voltage. Then, constant-voltage regulation is applied to maintain battery voltage at the battery equalization voltage. The battery will remain in the Equalize stage until setting battery equalized time is arrived.

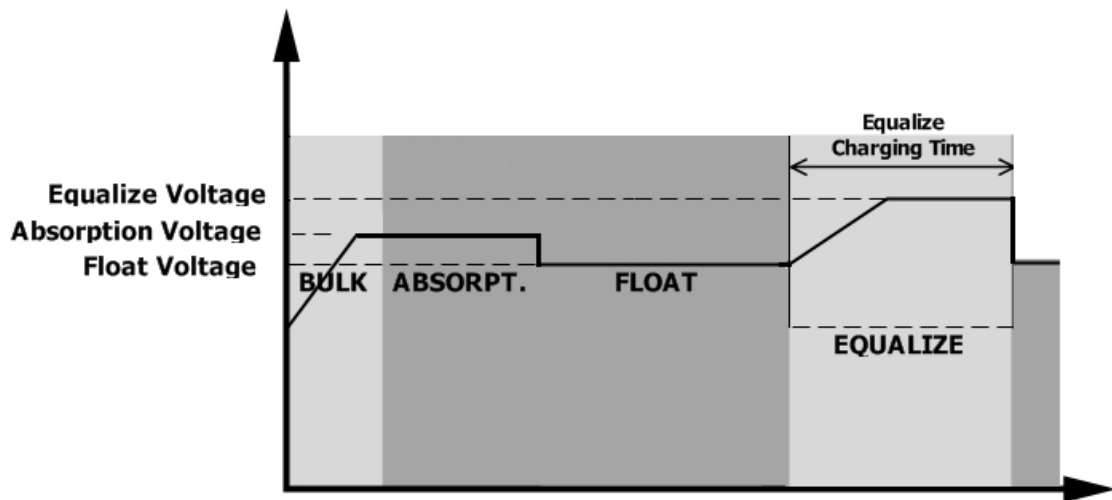

However, in Equalize stage, when battery equalized time is expired and battery voltage doesn't rise to battery equalization voltage point, the charge controller will extend the battery equalized time until battery voltage achieves battery equalization voltage. If battery voltage is still lower than battery equalization voltage when battery equalized timeout setting is over, the charge controller will stop equalization and return to float stage.

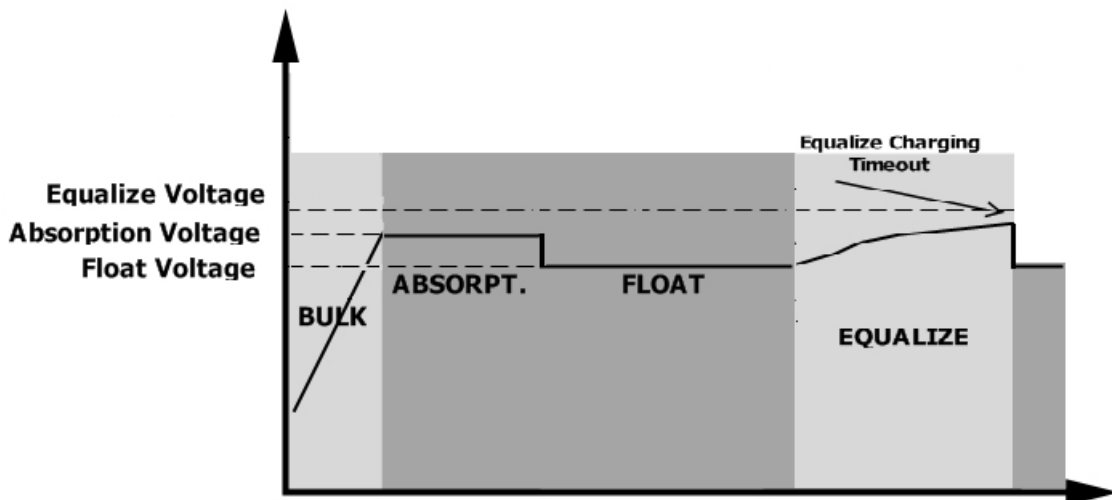

# SPECIFICATIONS

Table 1 Line Mode Specifications

INVERTER MODEL	5KW
<b>Input Voltage Waveform</b>	Sinusoidal (utility or generator)
<b>Nominal Input Voltage</b>	230Vac
<b>Low Loss Voltage</b>	170Vac±7V (UPS) 90Vac±7V (Appliances)
<b>Low Loss Return Voltage</b>	180Vac±7V (UPS); 100Vac±7V (Appliances)
<b>High Loss Voltage</b>	280Vac±7V
<b>High Loss Return Voltage</b>	270Vac±7V
<b>Max AC Input Voltage</b>	300Vac
<b>Nominal Input Frequency</b>	50Hz / 60Hz (Auto detection)
<b>Low Loss Frequency</b>	40±1Hz
<b>Low Loss Return Frequency</b>	42±1Hz
<b>High Loss Frequency</b>	65±1Hz
<b>High Loss Return Frequency</b>	63±1Hz
<b>Output Short Circuit Protection</b>	Line mode: Circuit Breaker Battery mode: Electronic Circuits
<b>Efficiency (Line Mode)</b>	>95% ( Rated R load, battery full charged )
<b>Transfer Time</b>	10ms typical (UPS); 20ms typical (Appliances)
<p><b>Output power derating:</b> When AC input voltage drops to 95V or 170V depending on models, the output power will be derated.</p>	 <p>The graph illustrates the output power derating characteristics. The vertical axis represents Output Power, with a horizontal line for Rated Power and a lower horizontal line for 50% Power. The horizontal axis represents Input Voltage, with markers at 90V, 170V, and 280V. The power output is zero until 90V, then rises to 50% of the rated power at 90V. From 90V to 170V, the power output increases linearly to reach the full Rated Power. From 170V to 280V, the power output remains constant at the Rated Power level. Beyond 280V, the power output drops to zero.</p>

Table 2 Inverter Mode Specifications

<b>INVERTER MODEL</b>	<b>5KW</b>
<b>Rated Output Power</b>	5KVA/5KW
<b>Output Voltage Waveform</b>	Pure Sine Wave
<b>Output Voltage Regulation</b>	230Vac±5%
<b>Output Frequency</b>	60Hz or 50Hz
<b>Peak Efficiency</b>	90%
<b>Overload Protection</b>	5s@≥150% load; 10s@110%~150% load
<b>Surge Capacity</b>	2* rated power for 5 seconds
<b>Nominal DC Input Voltage</b>	48Vdc
<b>Cold Start Voltage</b>	46.0Vdc
<b>Low DC Warning Voltage</b> @ load < 20% @ 20% ≤ load < 50% @ load ≥ 50%	44.0Vdc 42.8Vdc 40.4Vdc
<b>Low DC Warning Return Voltage</b> @ load < 20% @ 20% ≤ load < 50% @ load ≥ 50%	46.0Vdc 44.8Vdc 42.4Vdc
<b>Low DC Cut-off Voltage</b> @ load < 20% @ 20% ≤ load < 50% @ load ≥ 50%	42.0Vdc 40.8Vdc 38.4Vdc
<b>High DC Recovery Voltage</b>	64Vdc
<b>High DC Cut-off Voltage</b>	66Vdc

Table 3 Charge Mode Specifications

Utility Charging Mode		
<b>INVERTER MODEL</b>		<b>5KW</b>
<b>Charging Current (UPS)</b> @ Nominal Input Voltage		100A
<b>Bulk Charging Voltage</b>	<b>Flooded Battery</b>	58.4
	<b>AGM / Gel Battery</b>	56.4
<b>Floating Charging Voltage</b>		54Vdc
<b>Overcharge Protection</b>		66Vdc
<b>Charging Algorithm</b>		3-Step
<b>Charging Curve</b>		
Solar Input		
<b>INVERTER MODEL</b>		<b>5KW</b>
<b>Rated Power</b>		5000W
<b>Max. PV Array Open Circuit Voltage</b>		450Vdc
<b>PV Array MPPT Voltage Range</b>		120Vdc~430Vdc
<b>Max. Input Current</b>		18A

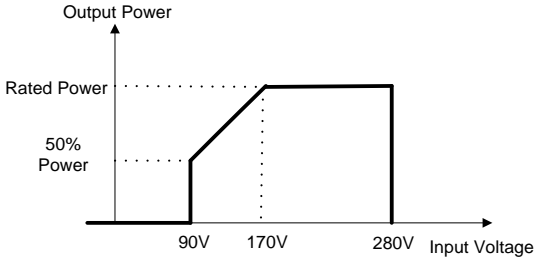
Table 4 General Specifications

<b>INVERTER MODEL</b>	<b>5 KW</b>
<b>Safety Certification</b>	CE
<b>Operating Temperature Range</b>	-10°C to 50°C
<b>Storage temperature</b>	-15°C~ 60°C
<b>Humidity</b>	5% to 95% Relative Humidity (Non-condensing)
<b>Dimension (D*W*H), mm</b>	140 x 295 x 468
<b>Net Weight, kg</b>	12

# TROUBLE SHOOTING

Problem	LCD/LED/Buzzer	Explanation / Possible cause	What to do
Unit shuts down automatically during startup process.	LCD/LEDs and buzzer will be active for 3 seconds and then complete off.	The battery voltage is too low (<1.91V/Cell)	1. Re-charge battery. 2. Replace battery.
No response after power on.	No indication.	1. The battery voltage is far too low. (<1.4V/Cell) 2. Battery polarity is connected reversed.	1. Check if batteries and the wiring are connected well. 2. Re-charge battery. 3. Replace battery.
Mains exist but the unit works in battery mode.	Input voltage is displayed as 0 on the LCD and green LED is flashing.	Input protector is tripped	Check if AC breaker is tripped and AC wiring is connected well.
	Green LED is flashing.	Insufficient quality of AC power. (Shore or Generator)	1. Check if AC wires are too thin and/or too long. 2. Check if generator (if applied) is working well or if input voltage range setting is correct. (UPS→Appliance)
	Green LED is flashing.	Set "Solar First" as the priority of output source.	Change output source priority to Utility first.
When the unit is turned on, internal relay is switched on and off repeatedly.	LCD display and LEDs are flashing	Battery is disconnected.	Check if battery wires are connected well.
Buzzer beeps continuously and red LED is on.	Fault code 07	Overload error. The inverter is overload 110% and time is up.	Reduce the connected load by switching off some equipment.
	Fault code 05	Output is short circuited.	Check if wiring is connected well and remove abnormal load.
		Temperature of internal converter component is over 120°C. (Only available for 1-3KVA models.)	Check whether the air flow of the unit is blocked or whether the ambient temperature is too high.
	Fault code 02	Internal temperature of inverter component is over 100°C.	
	Fault code 03	Battery is over-charged.	Return to repair center.
		The battery voltage is too high.	Check if spec and quantity of batteries are meet requirements.
	Fault code 01	Fan fault	Replace the fan.
	Fault code 06/58	Output abnormal (Inverter voltage below than 190Vac or is higher than 260Vac)	1. Reduce the connected load. 2. Return to repair center
	Fault code 08/09/53/57	Internal components failed.	Return to repair center.
	Fault code 51	Over current or surge.	Restart the unit, if the error happens again, please return to repair center.
Fault code 52	Bus voltage is too low.		
Fault code 55	Output voltage is unbalanced.		

# Appendix I: Parallel function

## 1. Introduction

This inverter can be used in parallel with two different operation modes.

1. Parallel operation in single phase with up to 9 units. The supported maximum output power is 45KW/45KVA.
2. Maximum nine units work together to support three-phase equipment. Seven units support one phase maximum. The supported maximum output power is 45KW/45KVA and one phase can be up to 35KW/35KVA.

**NOTE:** If this unit is bundled with share current cable and parallel cable, this inverter is default supported parallel operation. You may skip section 3. If not, please purchase parallel kit and install this unit by following instruction from professional technical personnel in local dealer.

**WARNING!** Please make sure all output N wires of each inverter must be always connected. Otherwise, it will cause inverter fault in error code # 72.

## 2. Package Contents

In parallel kit, you will find the following items in the package:

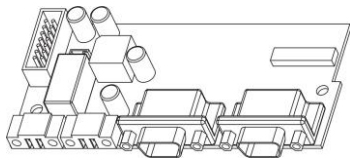

Parallel board



Parallel communication cable



Current sharing cable

## 3. Parallel board installation

**Step 1:** Remove wire cover by unscrewing all screws.

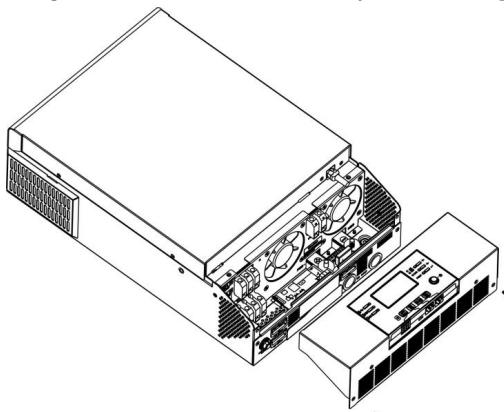

**Step 2:** Remove two screws as below chart and remove 2-pin and 14-pin cables. Take out the board under the communication board.

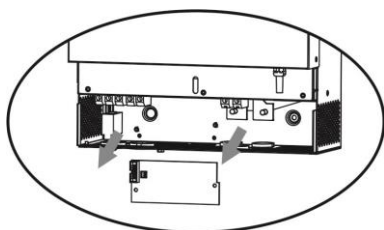

**Step 3:** Remove two screws as below chart to take out cover of parallel communication.

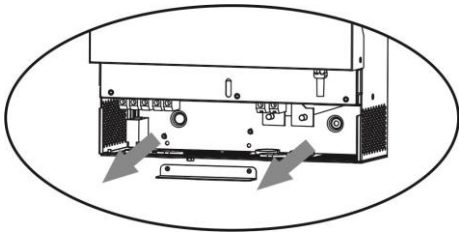

**Step 4:** Install new parallel board with 2 screws tightly.

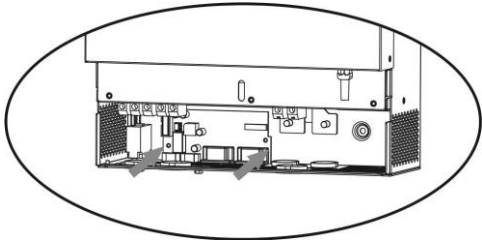

**Step 6:** Connect 2-pin to original position.

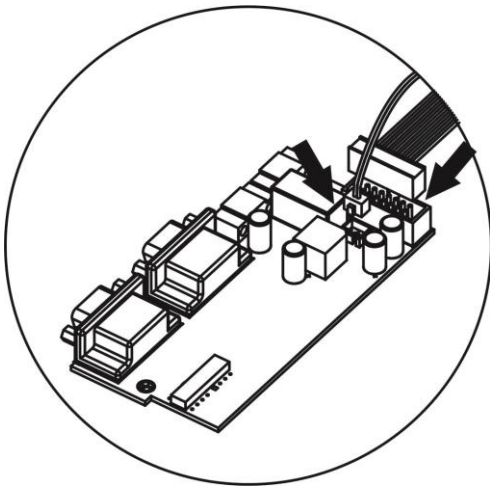

**Step 7:** Put communication board back to the unit.

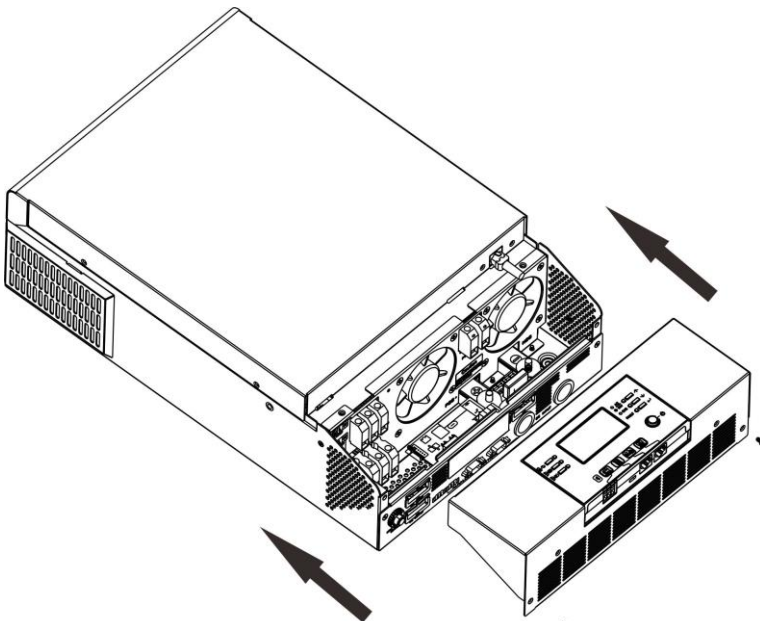

**Step 8:** Put wire cover back to the unit. Now the inverter is providing parallel operation function.



#### 4. Mounting the Unit

When installing multiple units, please follow below chart.

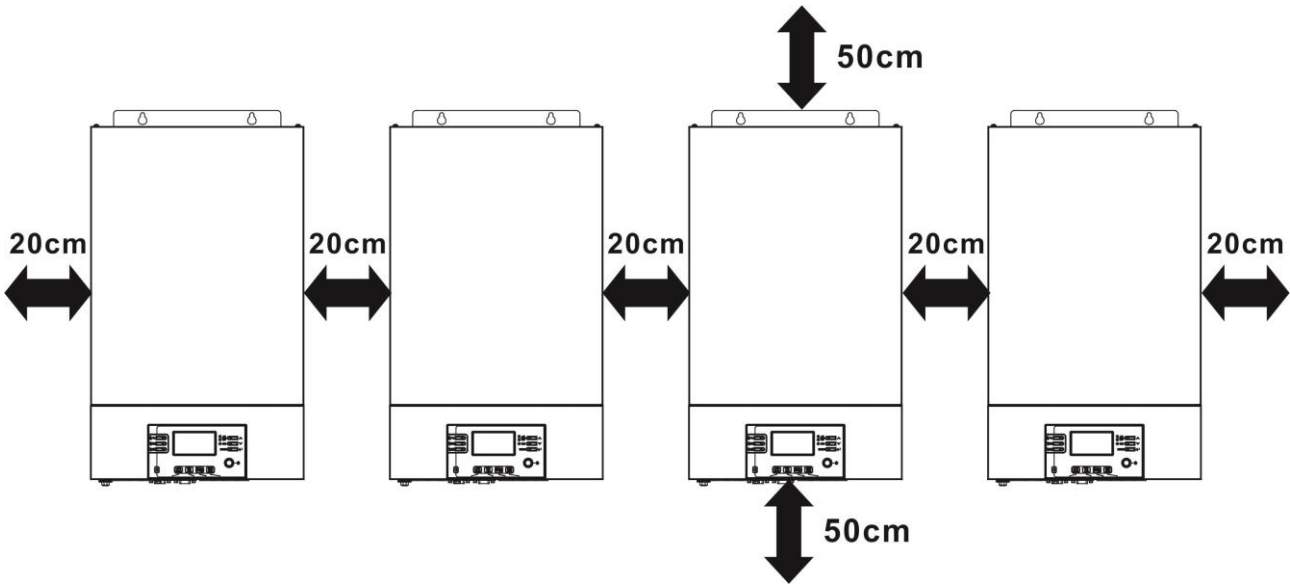

**NOTE:** For proper air circulation to dissipate heat, allow a clearance of approx. 20 cm to the side and approx. 50 cm above and below the unit. Be sure to install each unit in the same level.

#### 5. Wiring Connection

**NOTICE:** It's required to connect to battery for parallel operation.

The cable size of each inverter is shown as below:

**Recommended battery cable and terminal size for each inverter:**

Model	Wire Size	Cable mm <sup>2</sup>	Ring Terminal Dimensions		Torque value
			D (mm)	L (mm)	
5KW	2*4 AWG	44	6.4	49.7	2~3

**Ring terminal:**

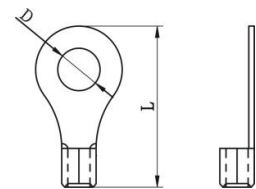

**WARNING:** Be sure the length of all battery cables is the same. Otherwise, there will be voltage difference between inverter and battery to cause parallel inverters not working.

**Recommended AC input and output cable size for each inverter:**

Model	AWG no.	Torque
5KW	10 AWG	1.2~ 1.6Nm

You need to connect the cables of each inverter together. Take the battery cables for example: You need to use a connector or bus-bar as a joint to connect the battery cables together, and then connect to the battery terminal. The cable size used from joint to battery should be X times cable size in the tables above. "X" indicates the number of inverters connected in parallel.

Regarding AC input and output, please also follow the same principle.

**CAUTION!!** Please install the breaker at the battery and AC input side. This will ensure the inverter can be securely disconnected during maintenance and fully protected from over current of battery or AC input. The recommended mounted location of the breakers is shown in the figures in 5-1 and 5-2.

**Recommended breaker specification of battery for each inverter:**

Model	1 unit*
5KW	135A/70VDC

\*If you want to use only one breaker at the battery side for the whole system, the rating of the breaker should be X times current of 1 unit. "X" indicates the number of inverters connected in parallel.

**Recommended breaker specification of AC input with single phase:**

Model	2 units	3 units	4 units	5 units	6 units	7 units	8 units	9 units
5KW	80A/ 230VAC	120A/ 230VAC	160A/ 230VAC	200A/ 230VAC	240A/ 230VAC	280A/ 230VAC	320A/ 230VAC	360A/ 230VAC

**Note1:** Also, you can use 50A breaker for only 1 unit and install one breaker at its AC input in each inverter.

**Note2:** Regarding three-phase system, you can use 4-pole breaker directly and the rating of the breaker should be compatible with the phase current limitation from the phase with maximum units

**Recommended battery capacity**

Inverter parallel numbers	2	3	4	5	6	7	8	9
Battery Capacity	200AH	400AH	400AH	600AH	600AH	800AH	800AH	1000AH

**WARNING!** Be sure that all inverters will share the same battery bank. Otherwise, the inverters will transfer to fault mode.

## 5-1. Parallel Operation in Single phase

Two inverters in parallel:

### Power Connection

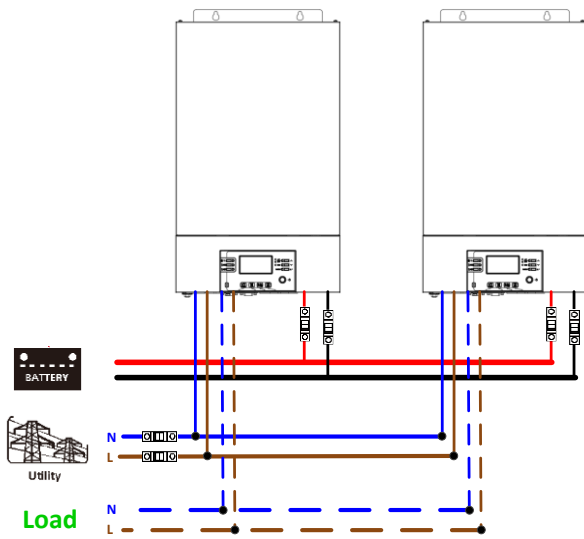

### Communication Connection

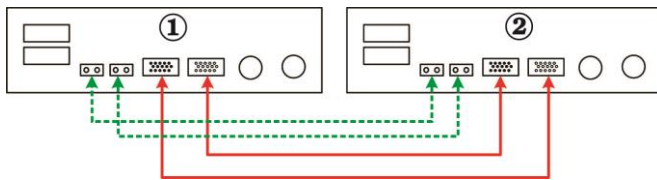

Three inverters in parallel:

### Power Connection

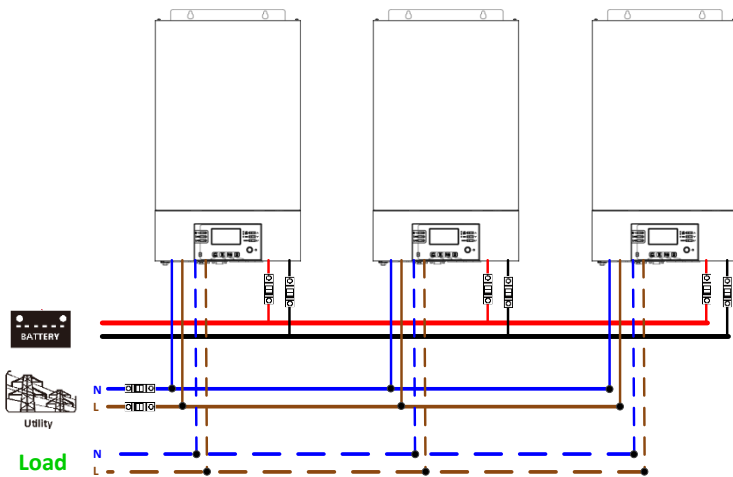

### Communication Connection

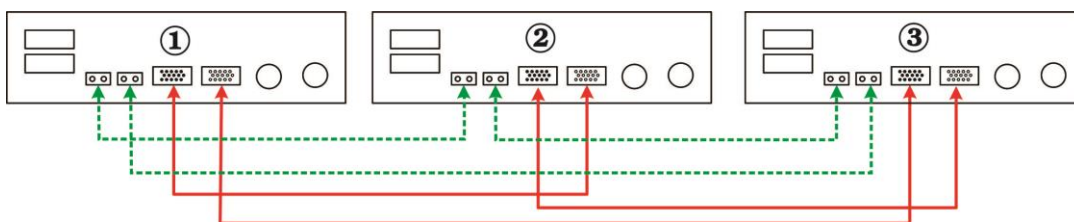

Four inverters in parallel:

### Power Connection

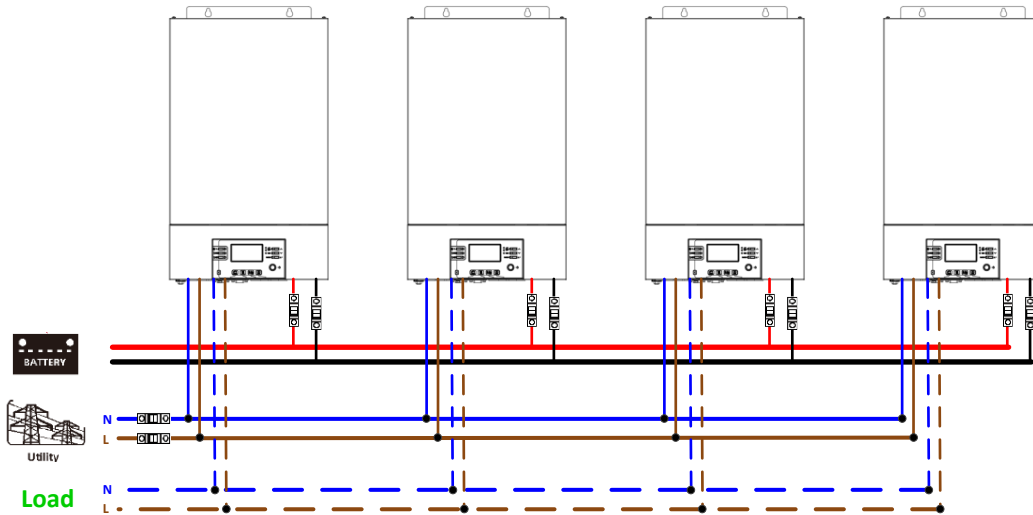

### Communication Connection

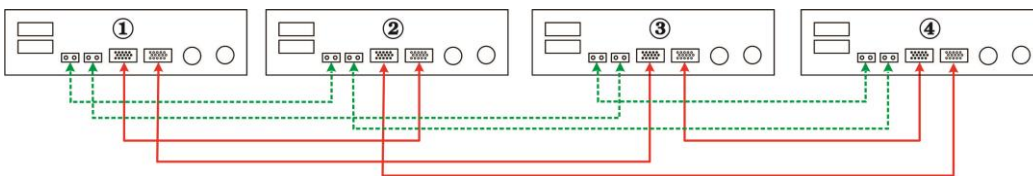

Five inverters in parallel:

### Power Connection

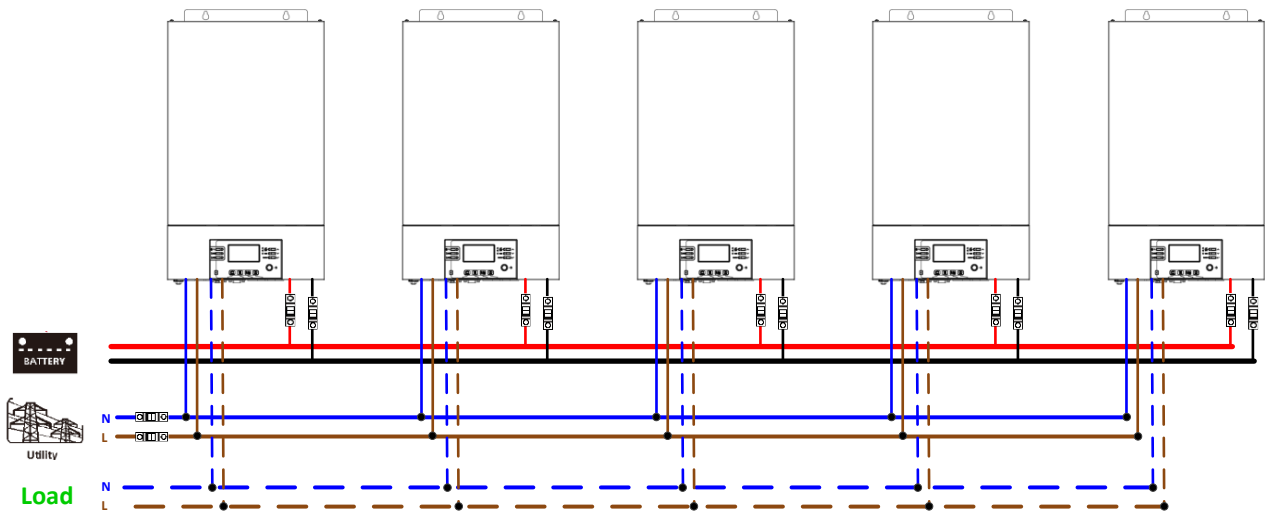

### Communication Connection

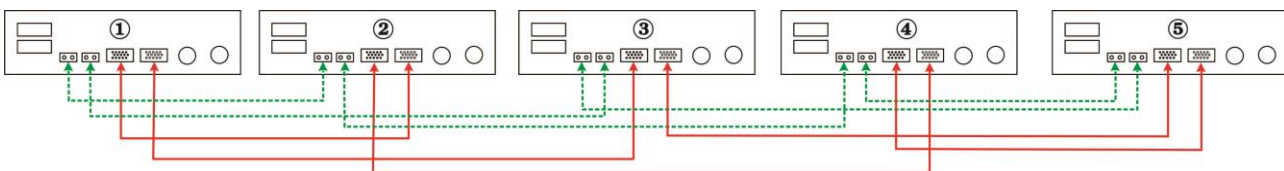

Six inverters in parallel:

### Power Connection

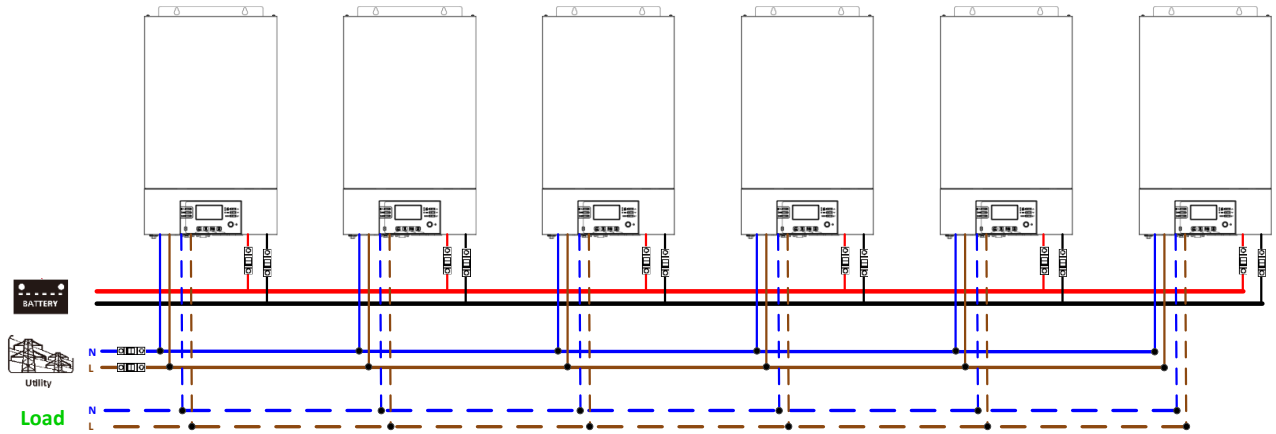

### Communication Connection

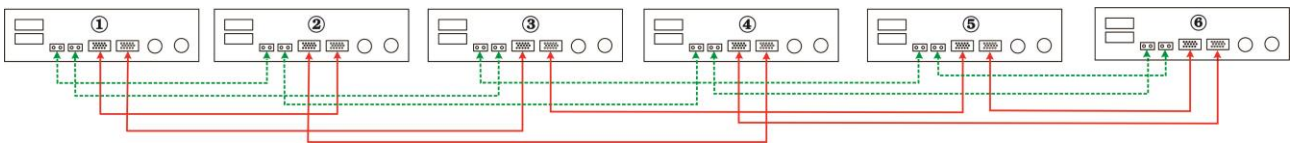

Seven inverters in parallel:

### Power Connection

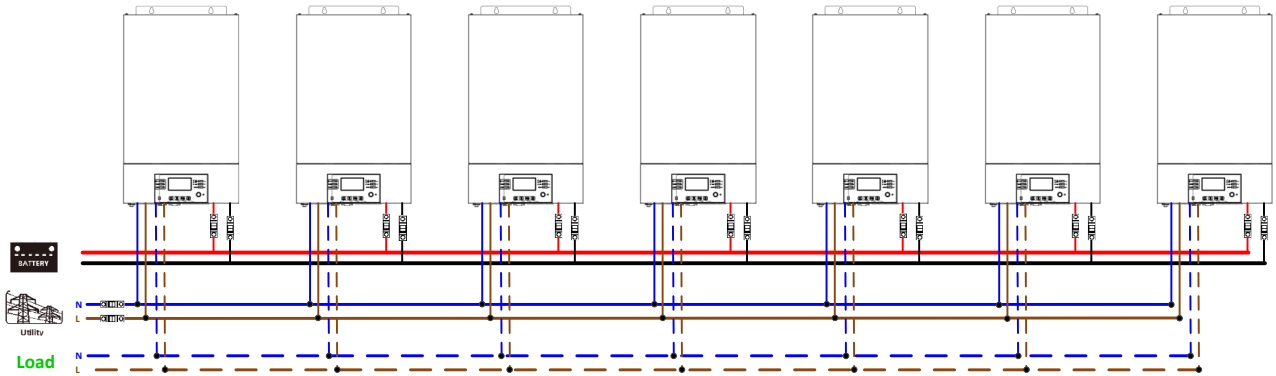

### Communication Connection

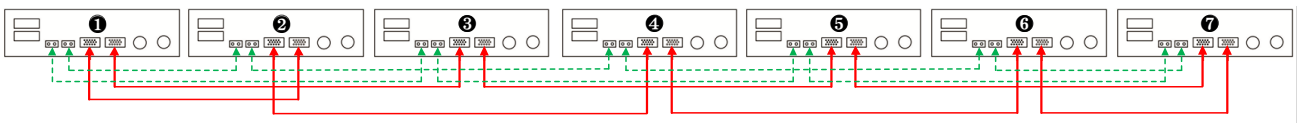

Eight inverters in parallel:

### Power Connection

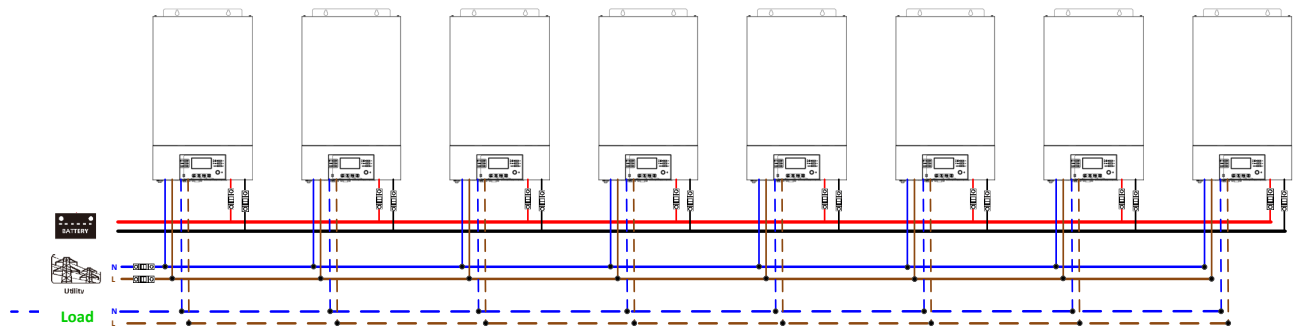

### Communication Connection

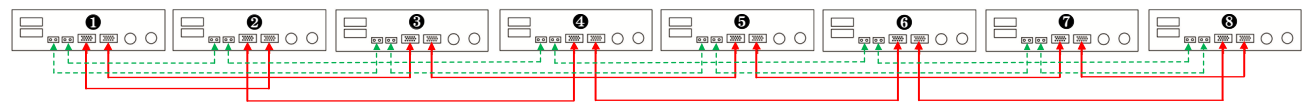

Nine inverters in parallel:

### Power Connection

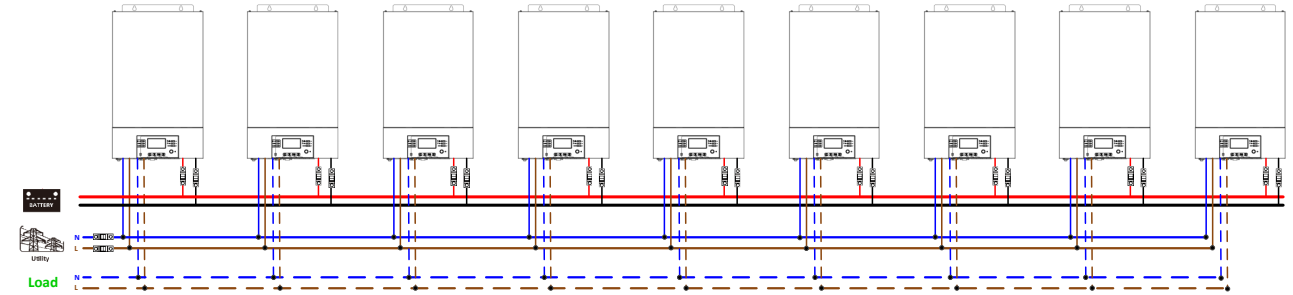

### Communication Connection

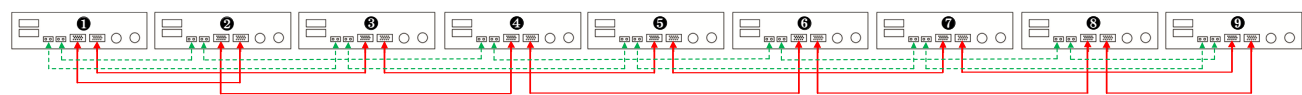

## 5-2. Support 3-phase equipment

Three inverters in each phase:

### Power Connection

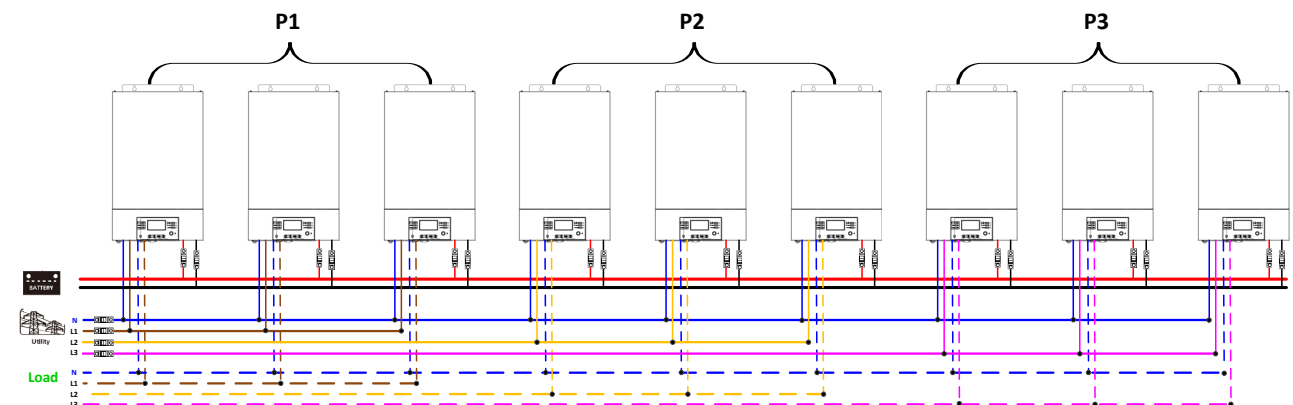

### Communication Connection

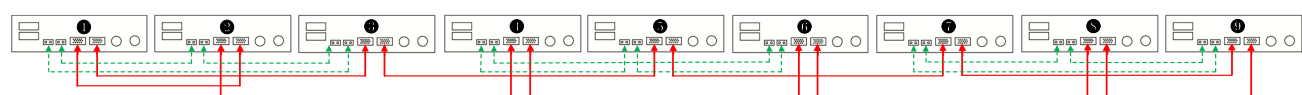

Three inverters in one phase, three inverters in second phase and two inverter for the third phase:

**Power Connection**

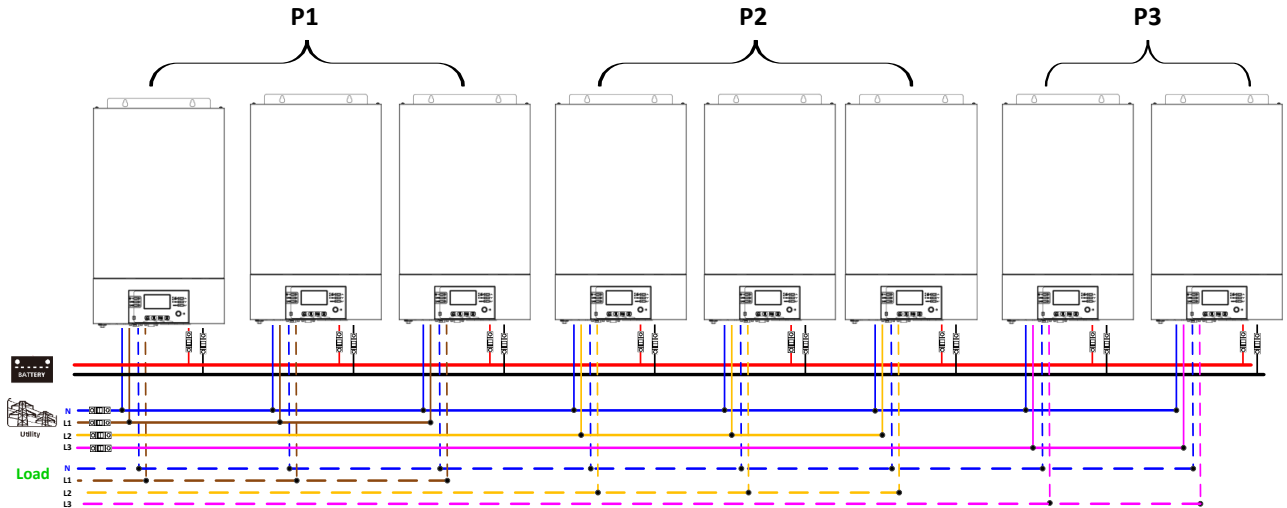

**Communication Connection**

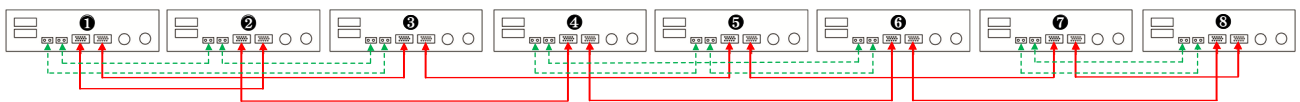

Three inverters in one phase, two inverters in second phase and two inverters for the third phase:

**Power Connection**

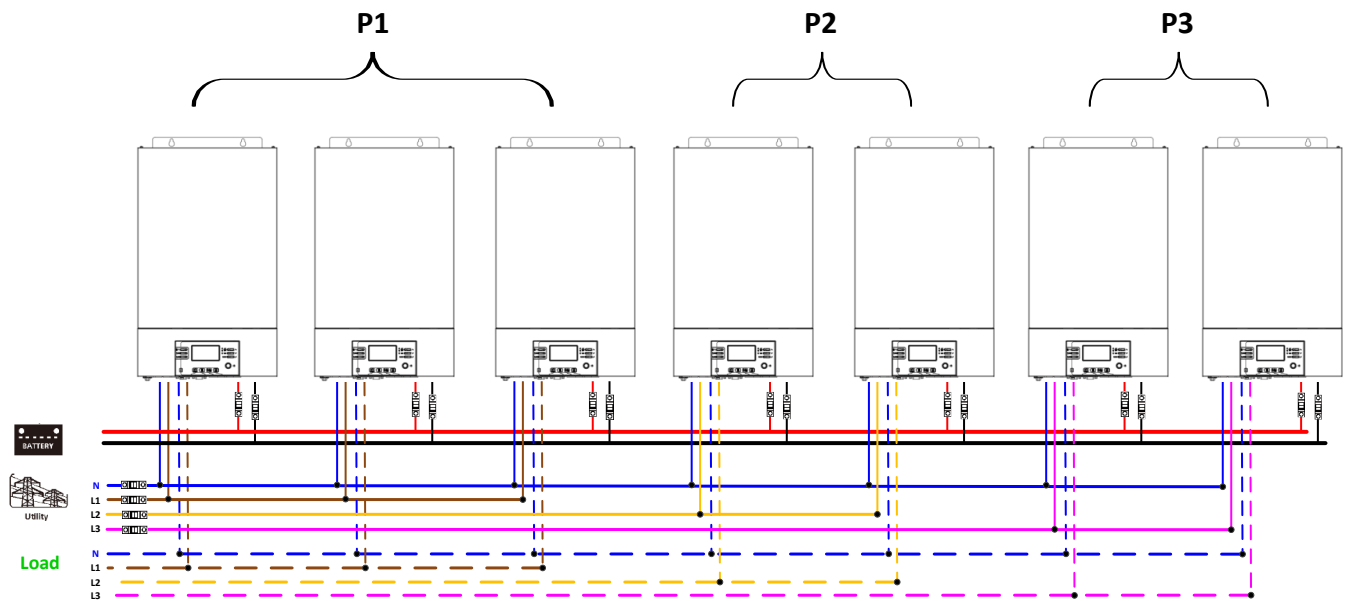

**Communication Connection**

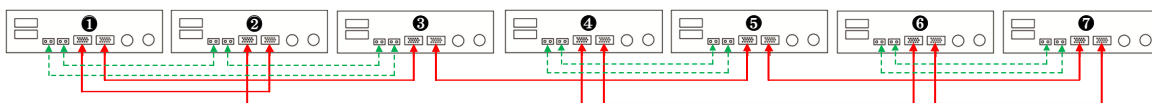

Two inverters in each phase:

**Power Connection**

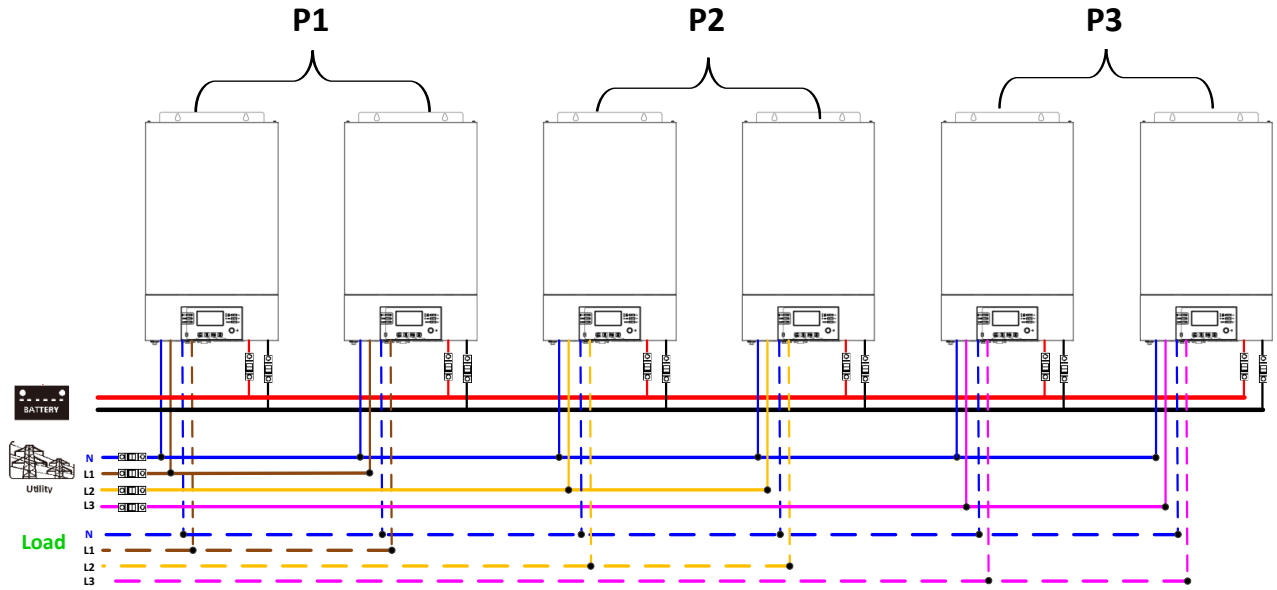

**Communication Connection**

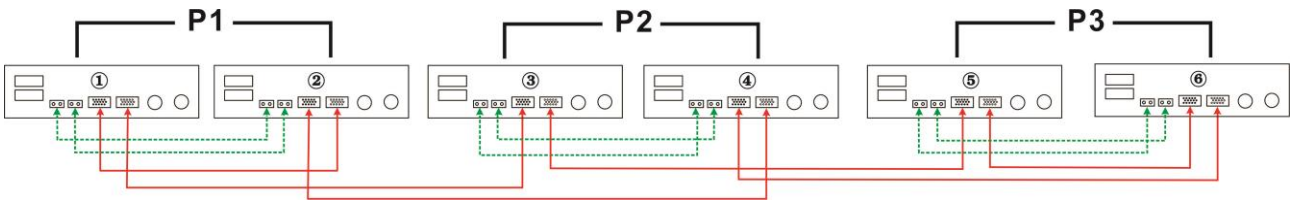

Seven inverters in one phase and one inverter for the other two phases:

**Power Connection**

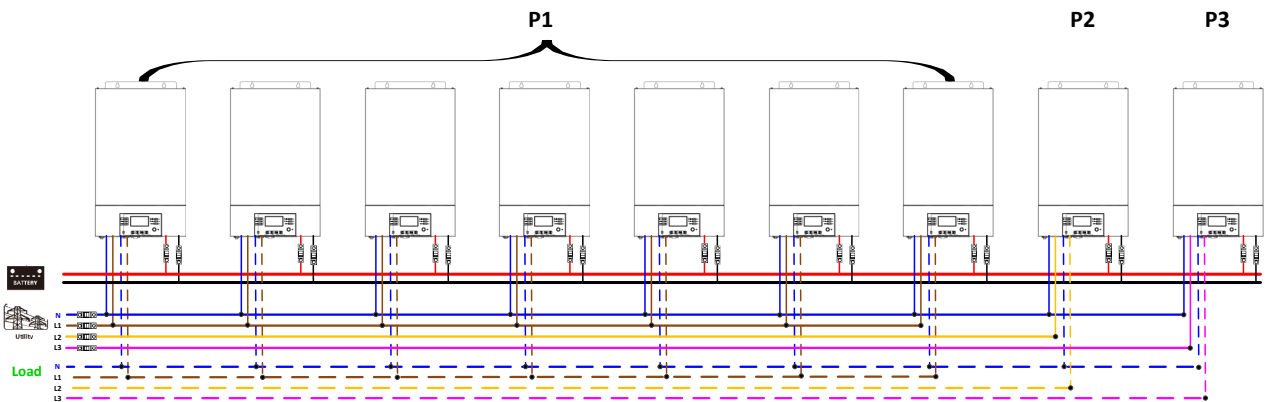

**Note:** It's up to customer's demand to pick 7 inverters on any phase.

P1: L1-phase, P2: L2-phase, P3: L3-phase.

**Communication Connection**

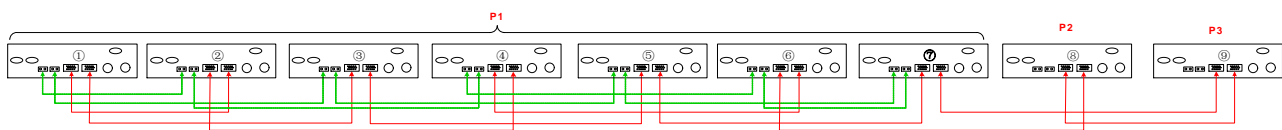

**Note:** If there is only one unit in one phase, this unit doesn't need to connect the current sharing cable.

Or you connect it like as below:



Four inverters in one phase and one inverter for the other two phases:

**Power Connection**

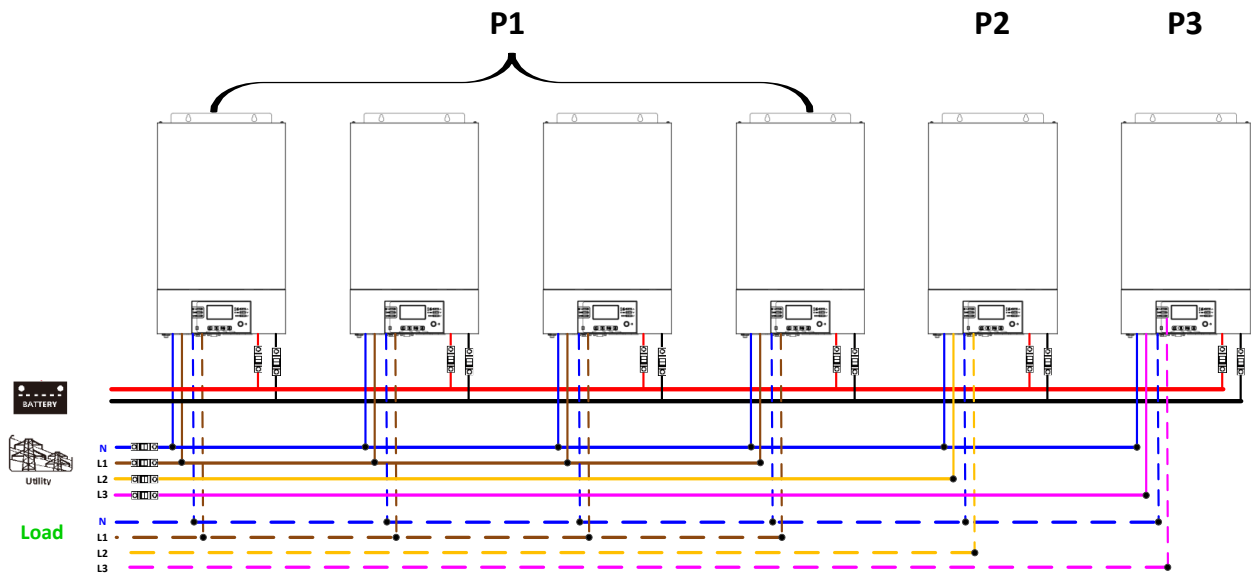

**Communication Connection**

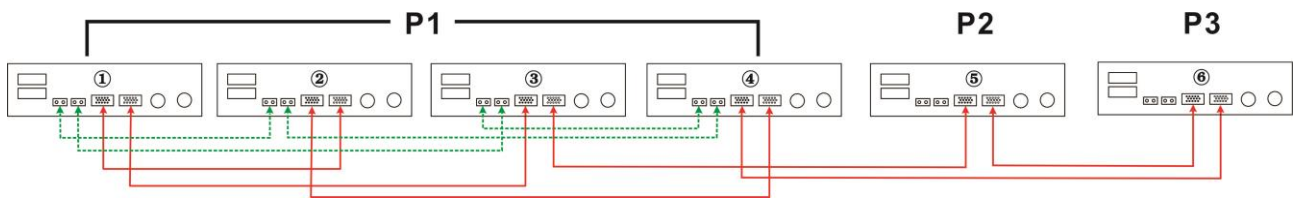

Three inverters in one phase, two inverters in second phase and one inverter for the third phase:

**Power Connection**

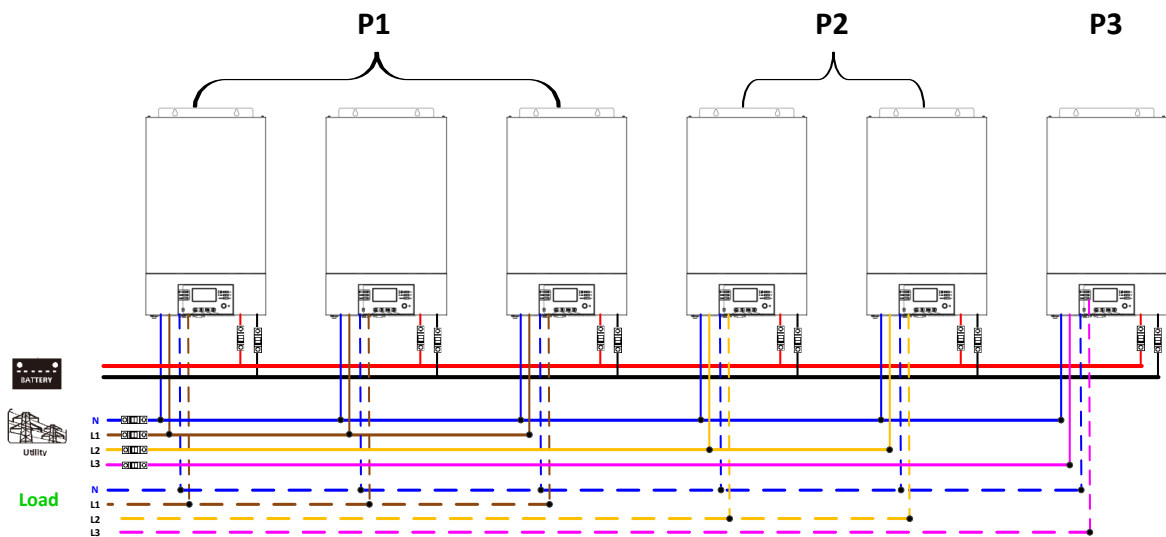

### Communication Connection

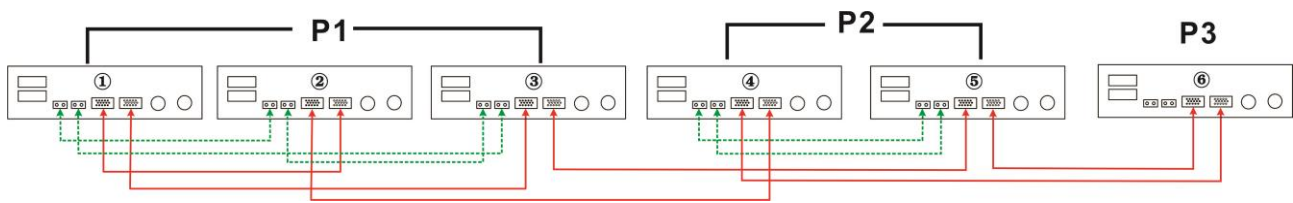

Three inverters in one phase and only one inverter for the remaining two phases:

### Power Connection

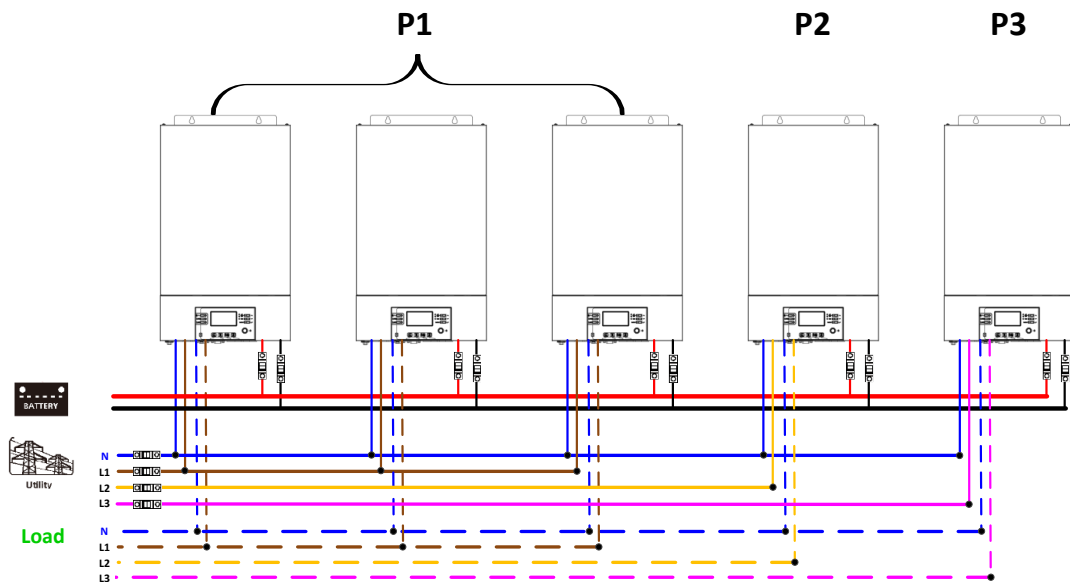

### Communication Connection

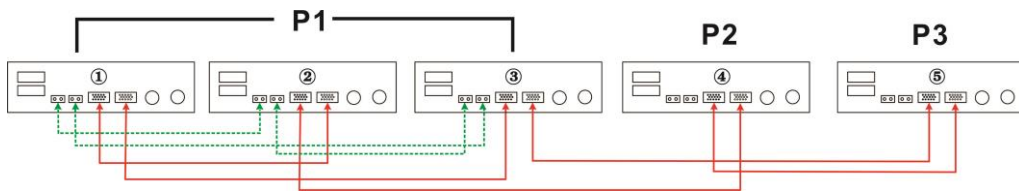

Two inverters in two phases and only one inverter for the remaining phase:

### Power Connection

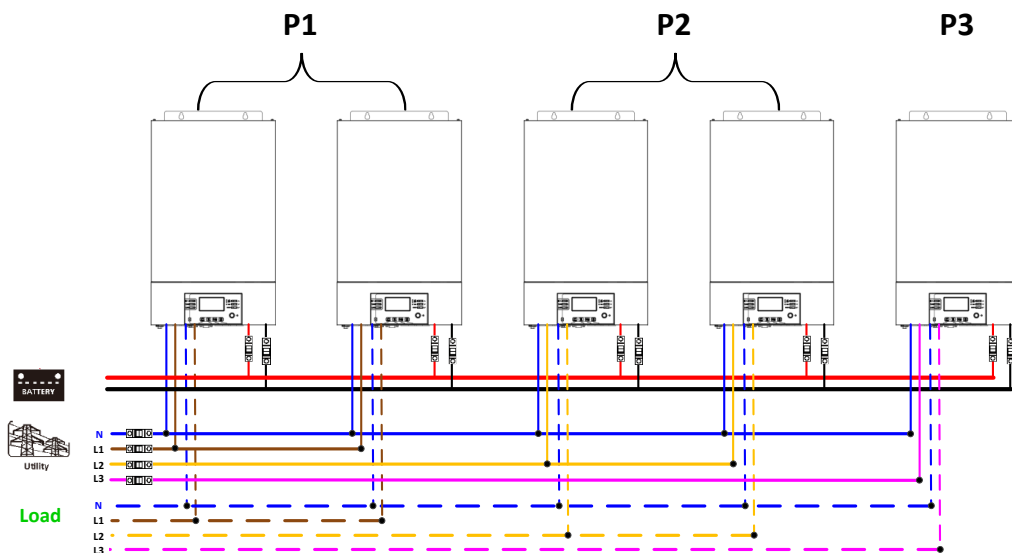

**Communication Connection**

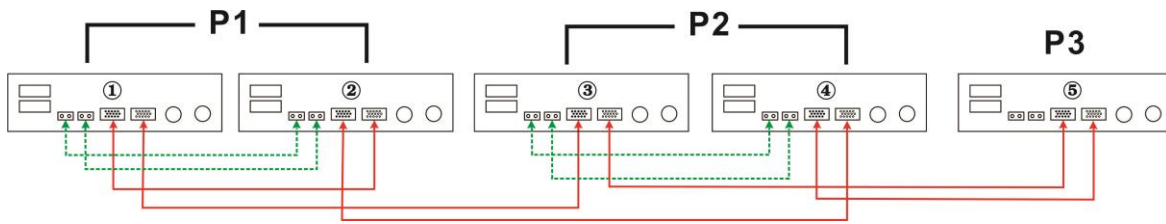

Two inverters in one phase and only one inverter for the remaining phases:

**Power Connection**

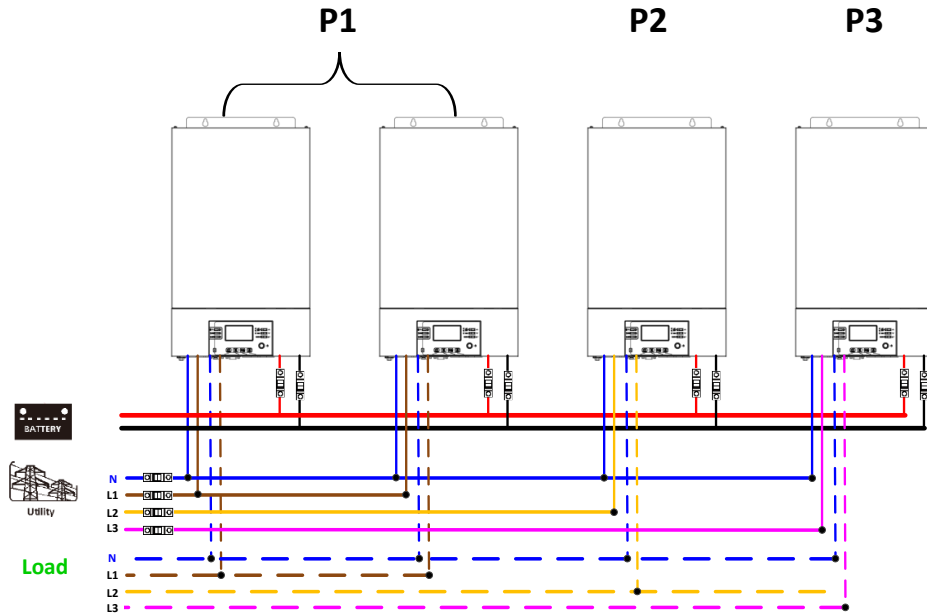

**Communication Connection**

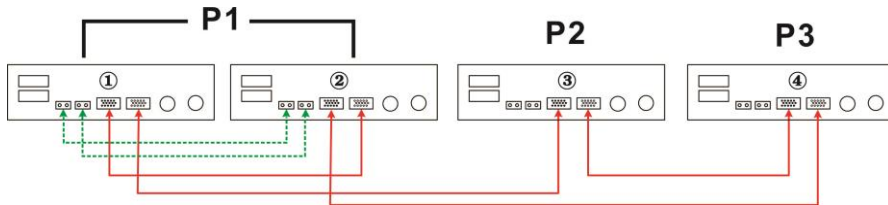

One inverter in each phase:

**Power Connection**

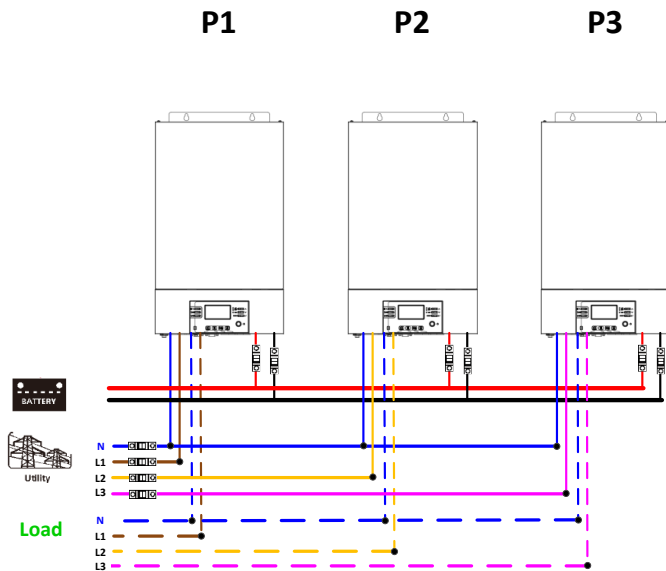

## Communication Connection

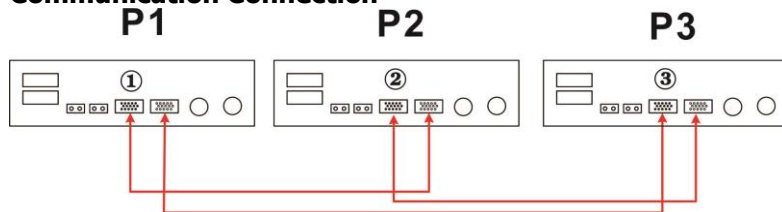

**WARNING:** Do not connect the current sharing cable between the inverters which are in different phases. Otherwise, it may damage the inverters.





## 6. PV Connection

Please refer to user manual of single unit for PV Connection.

**CAUTION:** Each inverter should connect to PV modules separately.

## 7. LCD Setting and Display

### Setting Program:

Program	Description	Selectable option
28	AC output mode *This setting is only available when the inverter is in standby mode (Switch off).	Single: 28  S10 Parallel: 28  PAL L1 phase: 28  3P1 L2 phase: 28  3P2 L3 phase: 28  3P3

When the units are used in parallel with single phase, please select "PAL" in program 28.

It is required to have at least 3 inverters or maximum 6 inverters to support three-phase equipment. It's required to have at least one inverter in each phase or it's up to four inverters in one phase. Please refers to 5-2 for detailed information. Please select "3P1" in program 28 for the inverters connected to L1 phase, "3P2" in program 28 for the inverters connected to L2 phase and "3P3" in program 28 for the inverters connected to L3 phase.

Be sure to connect share current cable to units which are on the same phase. Do NOT connect share current cable between units on different phases.

### Fault code display:

Fault Code	Fault Event	Icon on
60	Power feedback protection	F60
71	Firmware version inconsistent	F71
72	Current sharing fault	F72
80	CAN fault	F80
81	Host loss	F81
82	Synchronization loss	F82
83	Battery voltage detected different	F83
84	AC input voltage and frequency detected different	F84
85	AC output current unbalance	F85
86	AC output mode setting is different	F86

## 8. Commissioning

### Parallel in single phase

Step 1: Check the following requirements before commissioning:

- Correct wire connection
- Ensure all breakers in Line wires of load side are open and each Neutral wires of each unit are connected together.

Step 2: Turn on each unit and set "PAL" in LCD setting program 28 of each unit. And then shut down all units.

**NOET:** It's necessary to turn off switch when setting LCD program. Otherwise, the setting can not be programmed.

Step 3: Turn on each unit.

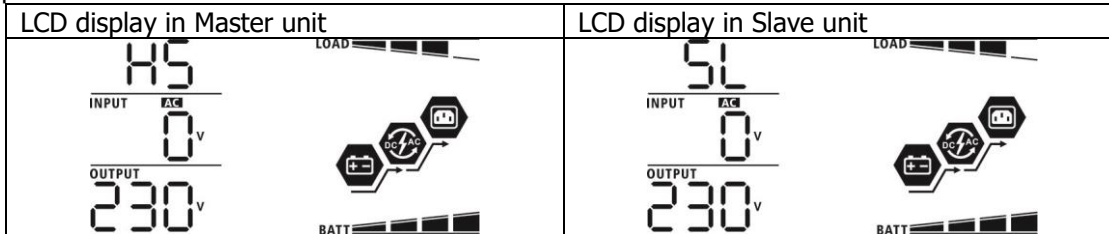

**NOTE:** Master and slave units are randomly defined.

Step 4: Switch on all AC breakers of Line wires in AC input. It's better to have all inverters connect to utility at the same time. If not, it will display fault 82 in following-order inverters. However, these inverters will automatically restart. If detecting AC connection, they will work normally.

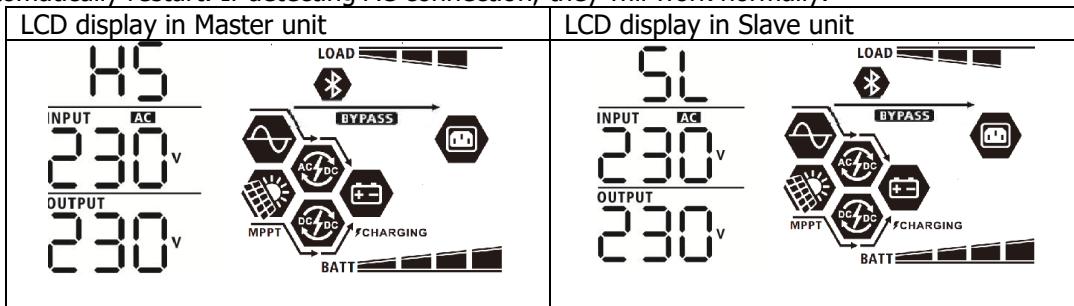

Step 5: If there is no more fault alarm, the parallel system is completely installed.

Step 6: Please switch on all breakers of Line wires in load side. This system will start to provide power to the load.

### Support three-phase equipment

Step 1: Check the following requirements before commissioning:

- Correct wire connection
- Ensure all breakers in Line wires of load side are open and each Neutral wires of each unit are connected together.

Step 2: Turn on all units and configure LCD program 28 as P1, P2 and P3 sequentially. And then shut down all units.

**NOET:** It's necessary to turn off switch when setting LCD program. Otherwise, the setting can not be programmed.

Step 3: Turn on all units sequentially.

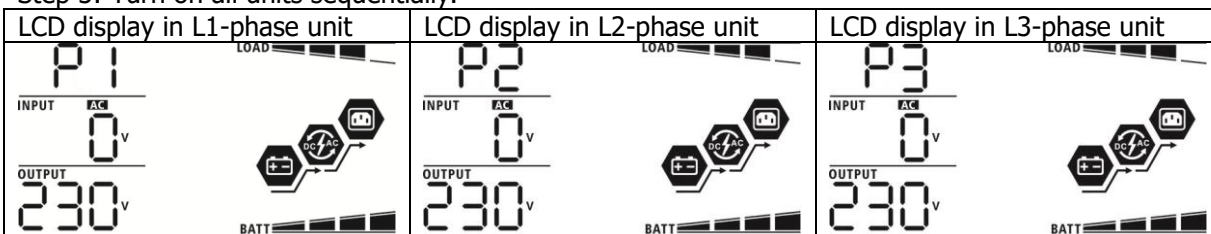

Step 4: Switch on all AC breakers of Line wires in AC input. If AC connection is detected and three phases are matched with unit setting, they will work normally. Otherwise, the AC icon will flash and they will not work in line mode.

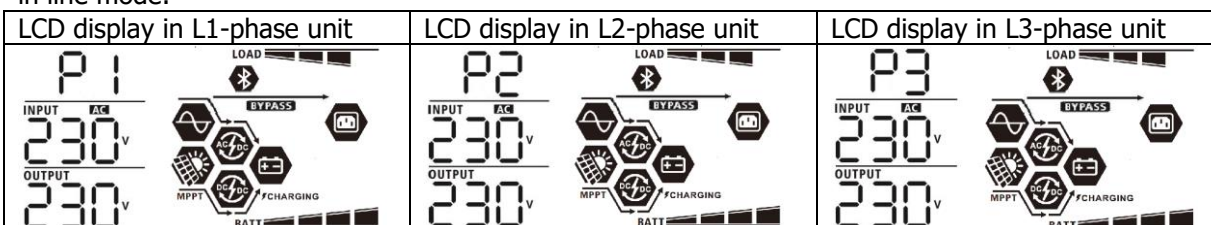

Step 5: If there is no more fault alarm, the system to support 3-phase equipment is completely installed.

Step 6: Please switch on all breakers of Line wires in load side. This system will start to provide power to the load.

Note 1: To avoid overload occurring, before turning on breakers in load side, it's better to have whole system in operation first.

Note 2: Transfer time for this operation exists. Power interruption may happen to critical devices, which cannot bear transfer time.

## 9. Trouble shooting

Situation		Solution
Fault Code	Fault Event Description	
60	Current feedback into the inverter is detected.	<ol style="list-style-type: none"> <li>1. Restart the inverter.</li> <li>2. Check if L/N cables are not connected reversely in all inverters.</li> <li>3. For parallel system in single phase, make sure the sharing are connected in all inverters. For supporting three-phase system, make sure the sharing cables are connected in the inverters in the same phase, and disconnected in the inverters in different phases.</li> <li>4. If the problem remains, please contact your installer.</li> </ol>
71	The firmware version of each inverter is not the same.	<ol style="list-style-type: none"> <li>1. Update all inverter firmware to the same version.</li> <li>2. Check the version of each inverter via LCD setting and make sure the CPU versions are same. If not, please contact your instraller to provide the firmware to update.</li> <li>3. After updating, if the problem still remains, please contact your installer.</li> </ol>
72	The output current of each inverter is different.	<ol style="list-style-type: none"> <li>1. Check if sharing cables are connected well and restart the inverter.</li> <li>2. If the problem remains, please contact your installer.</li> </ol>
80	CAN data loss	<ol style="list-style-type: none"> <li>1. Check if communication cables are connected well and restart the inverter.</li> <li>2. If the problem remains, please contact your installer.</li> </ol>
81	Host data loss	
82	Synchronization data loss	
83	The battery voltage of each inverter is not the same.	<ol style="list-style-type: none"> <li>1. Make sure all inverters share same groups of batteries together.</li> <li>2. Remove all loads and disconnect AC input and PV input. Then, check battery voltage of all inverters. If the values from all inverters are close, please check if all battery cables are the same length and same material type. Otherwise, please contact your installer to provide SOP to calibrate battery voltage of each inverter.</li> <li>3. If the problem still remains, please contact your installer.</li> </ol>
84	AC input voltage and frequency are detected different.	<ol style="list-style-type: none"> <li>1. Check the utility wiring connction and restart the inverter.</li> <li>2. Make sure utility starts up at same time. If there are breakers installed between utility and inverters, please be sure all breakers can be turned on AC input at same time.</li> <li>3. If the problem remains, please contact your installer.</li> </ol>
85	AC output current unbalance	<ol style="list-style-type: none"> <li>1. Restart the inverter.</li> <li>2. Remove some excessive loads and re-check load information from LCD of inverters. If the values are different, please check if AC input and output cables are in the same length and material type.</li> <li>3. If the problem remains, please contact your installer.</li> </ol>
86	AC output mode setting is different.	<ol style="list-style-type: none"> <li>1. Switch off the inverter and check LCD setting #28.</li> <li>2. For parallel system in single phase, make sure no 3P1, 3P2 or 3P3 is set on #28. For upporting three-phase system, make sure no "PAL" is set on #28.</li> <li>3. If the problem remains, please contact your installer.</li> </ol>

# Appendix II: BMS Communication Installation

## 1. Introduction

If connecting to lithium battery, it is recommended to purchase a custom-made RJ45 communication cable. Please check with your dealer or integrator for details.

This custom-made RJ45 communication cable delivers information and signal between lithium battery and the inverter. These information are listed below:

- Re-configure charging voltage, charging current and battery discharge cut-off voltage according to the lithium battery parameters.
- Have the inverter start or stop charging according to the status of lithium battery.

## 2. Lithium Battery Communication Configuration

### PYLONTECH

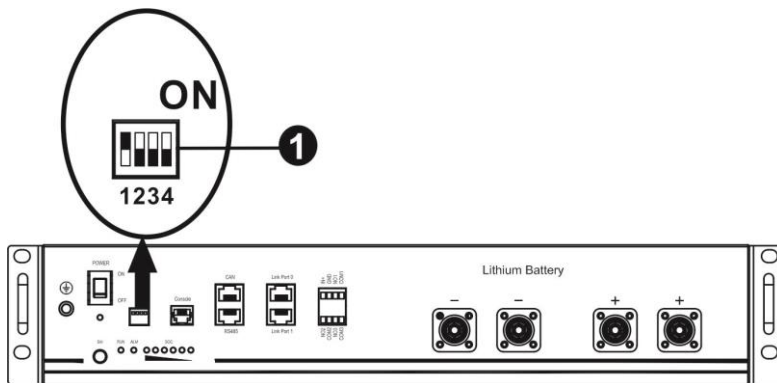

Dip Switch: There are 4 Dip Switches that sets different baud rate and battery group address. If switch position is turned to the "OFF" position, it means "0". If switch position is turned to the "ON" position, it means "1".

Dip 1 is "ON" to represent the baud rate 9600.

Dip 2, 3 and 4 are to set up battery group address.

Dip switch 2, 3 and 4 on master battery (first battery) are to set up or change the group address.

**NOTE:** "1" is upper position and "0" is bottom position.

Dip 1	Dip 2	Dip 3	Dip 4	Group address
1: RS485 baud rate=9600  <b>Restart to take effect</b>	0	0	0	Single group only. It's required to set up master battery with this setting and slave batteries are unrestricted.
	1	0	0	Multiple group condition. It's required to set up master battery on the first group with this setting and slave batteries are unrestricted.
	0	1	0	Multiple group condition. It's required to set up master battery on the second group with this setting and slave batteries are unrestricted.
	1	1	0	Multiple group condition. It's required to set up master battery on the third group with this setting and slave batteries are unrestricted.
	0	0	1	Multiple group condition. It's required to set up master battery on the fourth group with this setting and slave batteries are unrestricted.
	1	0	1	Multiple group condition. It's required to set up master battery on the fifth group with this setting and slave batteries are unrestricted.

**NOTE:** The maximum groups of lithium battery is 5 and for maximum number for each group, please check with battery manufacturer.



### 3. Installation and Operation

#### **PYLONTECH**

After configuration, please install LCD panel with inverter and Lithium battery with the following steps.

Step 1. Use a custom-made RJ45 cable to connect inverter and Lithium battery.

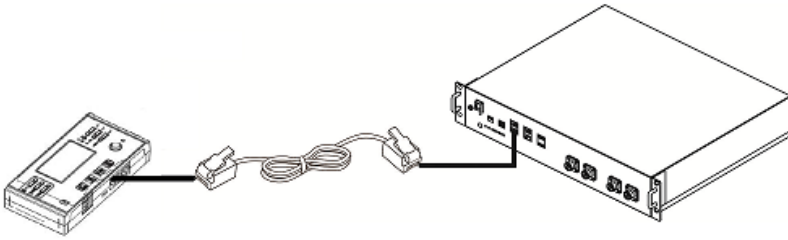

#### **Please take notice for parallel system:**

1. Only support common battery installation.
2. Use one custom-made RJ45 cable to connect any inverter (no need to connect to a specific inverter) and Lithium battery. Simply set battery type of this inverter to "PYL" in LCD program 5. The remaining inverters are set as "USE".

Step 2. Switch on Lithium battery.

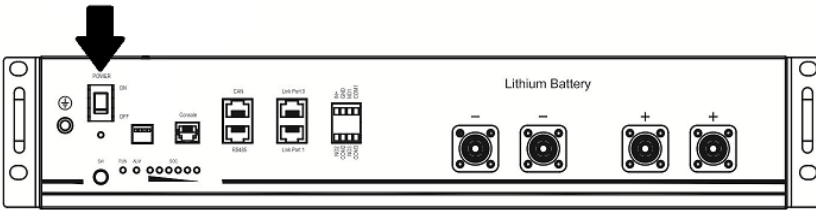

Step 3. Press more than three seconds to start Lithium battery, power output ready.

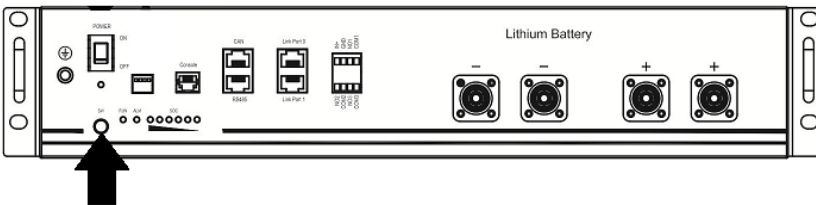

Step 4. Turn on the inverter.



Step 5. Be sure to select battery type as "PYL" in LCD program 5.

05 

PYL

## WECO

Step 1. Use a custom-made RJ45 cable to connect inverter and Lithium battery.

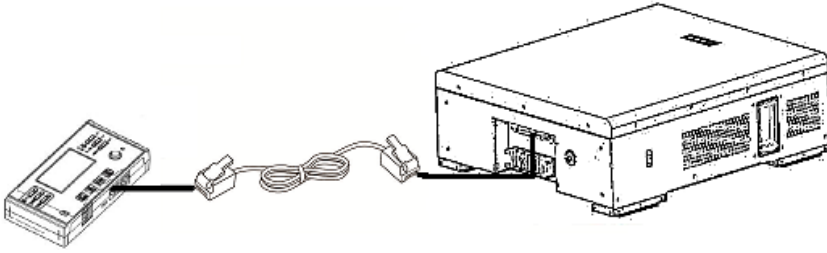

### Please take notice for parallel system:

1. Only support common battery installation.
2. Use one custom-made RJ45 cable to connect any inverter (no need to connect to a specific inverter) and Lithium battery. Simply set battery type of this inverter to "WEC" in LCD program 5. The remaining inverters are set as "USE".

Step 2. Switch on Lithium battery.

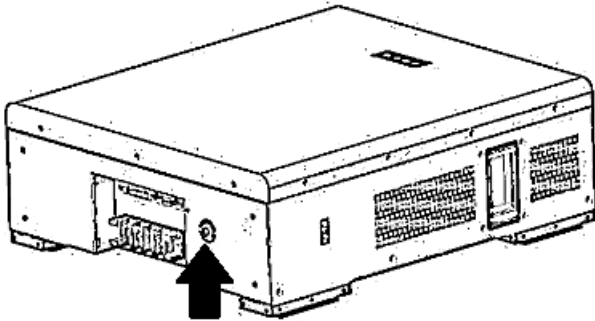

Step 3. Turn on the inverter.



Step 4. Be sure to select battery type as "WEC" in LCD program 5.

05 

WEC

If communication between the inverter and battery is successful, the battery icon  on LCD display will "flash". Generally speaking, it will take longer than 1 minute to establish communication.

## SOLTARO

Step 1. Use a custom-made RJ45 cable to connect inverter and Lithium battery.

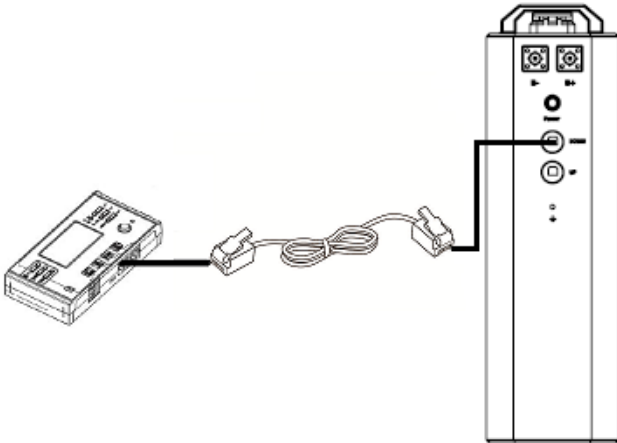

### Please take notice for parallel system:

1. Only support common battery installation.
2. Use one custom-made RJ45 cable to connect any inverter (no need to connect to a specific inverter) and Lithium battery. Simply set battery type of this inverter to "SOL" in LCD program 5. The remaining inverters are set as "USE".

Step 2. Open DC isolator and switch on Lithium battery.

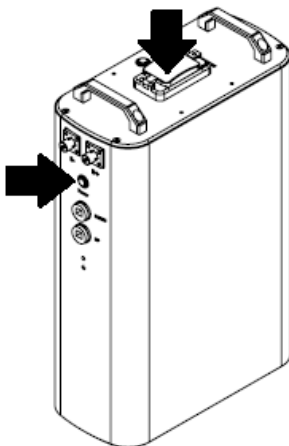

Step 3. Turn on the inverter.



Step 4. Be sure to select battery type as "SOL" in LCD program 5.

05 

SOL

If communication between the inverter and battery is successful, the battery icon  on LCD display will "flash". Generally speaking, it will take longer than 1 minute to establish communication.

## BAK

Step 1. Use custom-made RJ45 cable to connect inverter and Lithium battery.

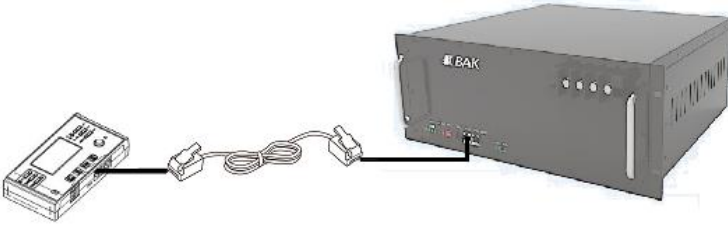

### Please take notice for parallel system:

1. Only support common battery installation.
2. Use one custom-made RJ45 cable to connect any inverter (no need to connect to a specific inverter) and Lithium battery. Simply set battery type of this inverter to "BAK" in LCD program 5. The remaining inverters are set as "USE".
3. Set the DIP address switches to "ON OFF OFF OFF" if it is a single battery. If multiple batteries in parallel, connect the RJ45 to the master unit's RS485 connector.

Step 2. Press more than three seconds to start Lithium battery, power output ready.



Step 3. Turn on the inverter.



Step 5. Be sure to select battery type as "BAK" in LCD program 5.

05 

bat

If communication between the inverter and battery is successful, the battery icon  on LCD display will "flash". Generally speaking, it will take longer than 1 minute to establish communication.

#### 4. LCD Display Information

Press "UP" or "DOWN" key to switch LCD display information. It will show battery pack and battery group number before "Main CPU version checking" as below screen.

Selectable information	LCD display
Battery pack numbers & Battery group numbers	Battery pack numbers = 3, battery group numbers = 1 

#### 5. Code Reference

Related information code will be displayed on LCD screen. Please check inverter LCD screen for the operation.

Code	Description
60	If battery status is not allowed to charge and discharge after the communication between the inverter and battery is successful, it will show code 60 to stop charging and discharging battery.
61	Communication lost (only available when the battery type is setting as "Pylontech Battery", "WECO Battery", "Soltaro Battery" or "BAK Battery".) <ul style="list-style-type: none"> <li>After battery is connected and communication signal is not detected for 3 minutes, buzzer will beep. After 10 minutes, inverter will stop charging and discharging to lithium battery.</li> <li>Communication lost occurs after the inverter and battery is connected successfully. Then, buzzer beeps immediately.</li> </ul>
69	If battery status is not allowed to charge after the communication between the inverter and battery is successful, it will show code 69 to stop charging battery.
70	If battery status must to be charged after the communication between the inverter and battery is successful, it will show code 70 to charge battery.
71	If battery status is not allowed to discharge after the communication between the inverter and battery is successful, it will show code 71 to stop discharging battery.

## Appendix III: Approximate Back-up Time Table

Model	Load (VA)	Backup Time @ 48Vdc 200Ah (min)	Backup Time @ 48Vdc 400Ah (min)
5KW	500	1226	2576
	1000	536	1226
	1500	316	804
	2000	222	542
	2500	180	430
	3000	152	364
	3500	130	282
	4000	100	224
	4500	88	200
	5000	80	180

**Note:** Backup time depends on the quality of the battery, age of battery and type of battery.  
Specifications of batteries may vary depending on different manufacturers.