

Applications

Make	Model	Year	Type
Peugeot	508	2011-2015	GT HDi HDi CrossTourer eD4 SD4 TD4 TD4e
	607	2000-2009	
	807	2002-2010	
	Boxer II	2002-2006	
	4007	2007-2012	
	406/Coupe	2000-2006	
Citroën	407	2006-2011	
	C5/II/III	2000-2009	
	C6	2007-2011	
	C8	2002-2010	
	C-Crosser	2007-2012	
Land Rover	Relay/Jumper II	2002-2006	
	Freelander 2	2006-2015	
	Range Rover Evoque	2011-2015	

Engine Code	
2.2	DW12CTED4 (4HL), DW12ATED (4HX), DW12BTEd4 (4HP), DW12BTEd4 (4HT) DW12BTEd4 (4HR), DW12BTEd4 (4HS), DW12TED4/L4 (4HW), DW12UTED (4HY) 4HX (DW12TED4), 4HP (DW12BTEd4), 4HR (DW12BTEd4), 4HT (DW12BTEd4) 4HL (DW12CTED4), 4HR (DW12BTEd4), 4HW(DW12TED4/L4), 4HK (DW12MTEd4) 4HN (DW12MTEd4), 4HY (DW12UTED), DW12CTED4/224DT, DW12BTEd4/224DT DW12MTEd4 (4HK), DW12MTEd4 (4HN), DW12ATED (4HZ), 4HS (DW12BTEd4)

Our products are designed to be used correctly and with care for the purpose for which they are intended. No liability is accepted by Sonic for incorrect use of any of our products, and Sonic cannot be held responsible for any damage to personnel, property or equipment when using the tools. Incorrect use will also invalidate the warranty.

If applicable, the applications database and any instructional information provided has been designed to offer general guidance for a particular tool's use and while all attention is given to the accuracy of the data no project should be attempted without referring first to the manufacturer's technical documentation (workshop or instruction manual) or the use of a recognised authority such as Autodata.

It is our policy to continually improve our products and thus we reserve the right to alter specifications and components without prior notice. It is the responsibility of the user to ensure the suitability of the tools and information prior to their use.

SONIC

equipment

Instructions

Engine Timing Kit

Jaguar Land Rover, Ford, PSA Diesel

DW12 - 2.2



829040 - Engine Timing Kit

Description:

The 829040 is a compact tool set which includes the camshaft sprocket, flywheel locking tools and flywheel timing pin required when setting the valve timing and/or changing the timing belt on DW12 (2.2lt) diesel engines found in the Land Rover, Ford, Peugeot and Citroen ranges.

Components

Ref	Comp	OEM	Description
1	4880096	303-1277, 0188.M	Camshaft Pulley Timing Pin
2	4880061	303-1272, 0188.F	Flywheel Locking Tool-(Ford)
3	4880068	303-1270, 303-1059	Flywheel Locking Timing Pin
4	4880080	0188AH	Centraliser Spring
5	4880106	0188F	Flywheel Lock

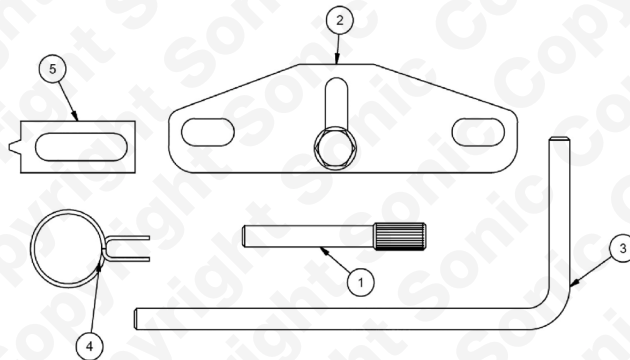

Instructions

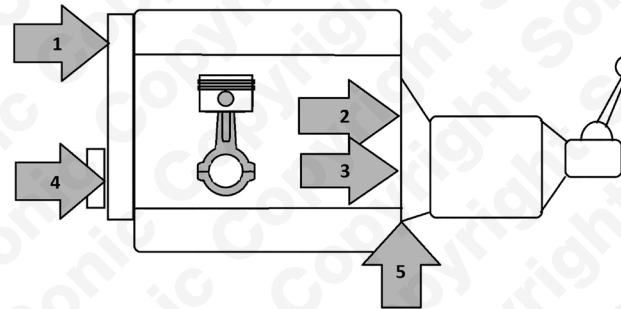

Component Descriptions:

Component 1 - Camshaft Pulley Timing Pin.

N.B. this pin is not designed to lock the cam shaft against the torque of undoing the cam shaft fixing. Use an appropriate pulley holding tool if removal of the pulley is required.

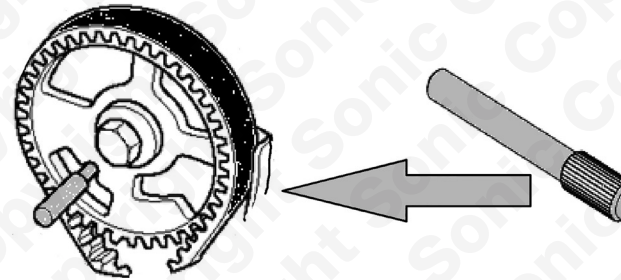

Component 2 - Flywheel Locking Tool-(Ford)

Component 2 is used to lock the flywheel against the torque required to loosen the crankshaft pulley fixings. Component C requires the removal of the starter motor.

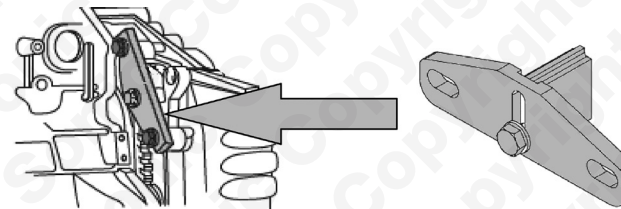

Component 3 - Flywheel Locking Timing Pin.

Component 3 is used to set the crankshaft in its timed position by locking the Flywheel as shown.

NOTE: do not torque against component 3, use component 2 or 5.

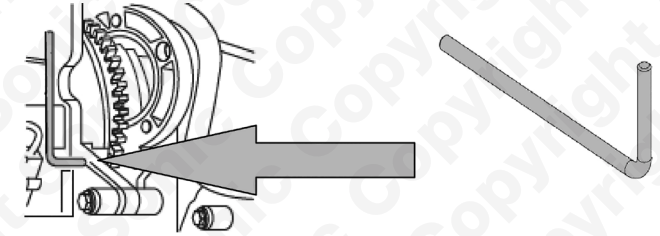

Component 4 - Centraliser Spring.

Component 4 is centralise the crankshaft cam belt sprocket when refitting it.

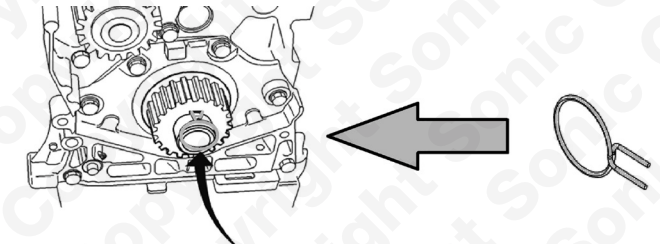

Component 5 - Flywheel Lock (Citroen/Peugeot)

Component 5 is used to lock the flywheel while tightening or loosening the crankshaft front pulley (PSA vehicles).

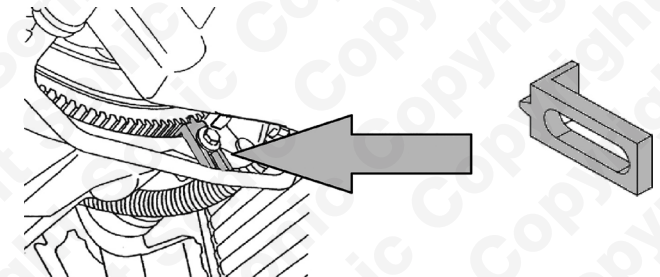

Instructions

The following instructions are for guidance only. Please refer to OEM derived data such as the vehicles manufactures own data or Autodata.

The use of these engine timing tools is purely down to the user's discretion and Sonic cannot be held responsible for any damage caused what so ever.

