

# TONE

---

TOUCH 03



ORIGINAL INSTRUCTIONS

## TOUCH 03

---

03 | Dimensions

---

04 | General instruction

---

05 | Installation instruction

---

06 | Plumbing connection

---

07 | Electrical connection

---

08 | General terms for safe use / Initial Set-Up

---

09 | Machine overview

---

10 | Brewing | Button functions

---

11 | Button functions | Trouble shooting

---

12 | Connecting the TONE Touch 03

---

13 | Connecting the TONE Touch 03

---

14 | Edit recipes

---

15 | Edit recipes

---

16 | Edit recipes

---

17 | Edit recipes

---

18 | Edit recipes

---

19 | Edit recipes

---

20 | Advanced tab

---

21 | Advanced tab

---

22 | Service tab

---

23 | Service tab

---

24 | Cleaning / Descaling

---

25 | Warranty

---

26 | TOUCH 03 - Wiring

---

27 | Technical Data / Declaration / Contact

---

# Dimensions

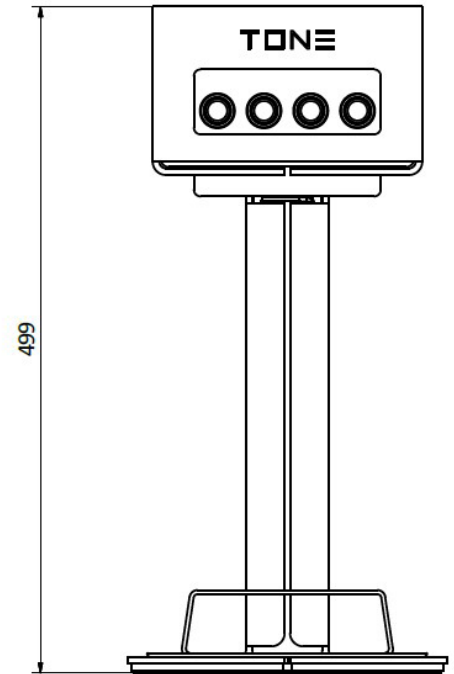
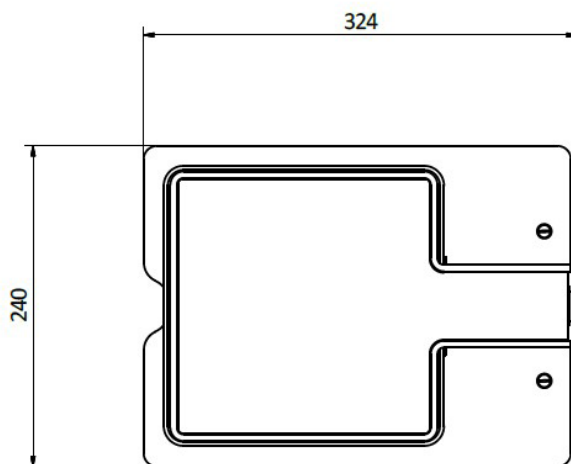
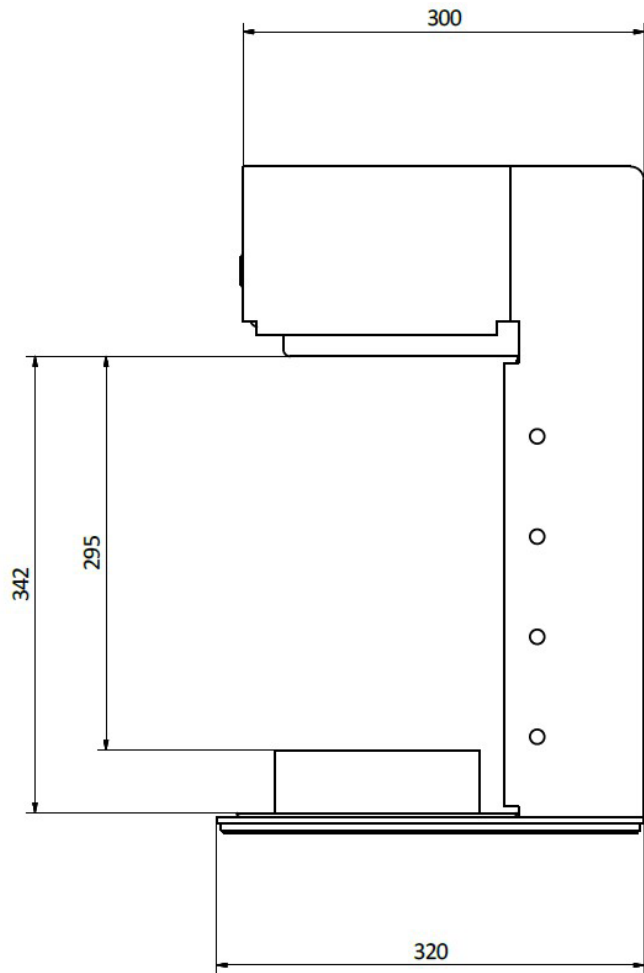

This appliance can be used exclusively by skilled professionals. Avoid the use of this appliance by children or unqualified persons.

This machine shall be destined exclusively to the use it has been expressly designed for. Any other use shall be considered ill-suited and improper. The manufacturer shall not be considered responsible for any damages caused by improper use.

Children shall be supervised and never allowed to play with the appliance.

Children shall be never allowed to clean or maintenance the appliance.

The electric safety of the machine is achieved only when the machine is correctly connected to a grounded electric system.

The user shall arrange electric, water and draining systems in a suitable position to allow correct machine installation.

The installer of TONE devices is not responsible for making modifications to existing water and power connections in the customers facilities.

If the electric supply cable is damaged, it must be replaced by another cable provided by the manufacturer or by its Technical Service.

For good machine functioning and maintenance, it is mandatory to install a water softener in order to avoid scale formation. This must be evaluated by the installer and the user shall leave a space for the correct installation of a water softener, following the instructions contained in its manual.

The machine shall be placed on a surface guaranteeing secure support. The machine must be connected exclusively to an appropriate cold drinking water source, in compliance with national norms and rules. The pressure of the incoming water must be between 1.5bar and 3bar. If this requirement is not met, consult the manufacturer.

A shut-o tap must be installed between machine water hose and water system to block water flow in case of necessity.

Do not use water jet devices in the area where TONE 03 is installed!

Do **NOT** tilt TONE 03 during operation! Max. tilt angle < 5°.

Only to be operated by trained personnel!

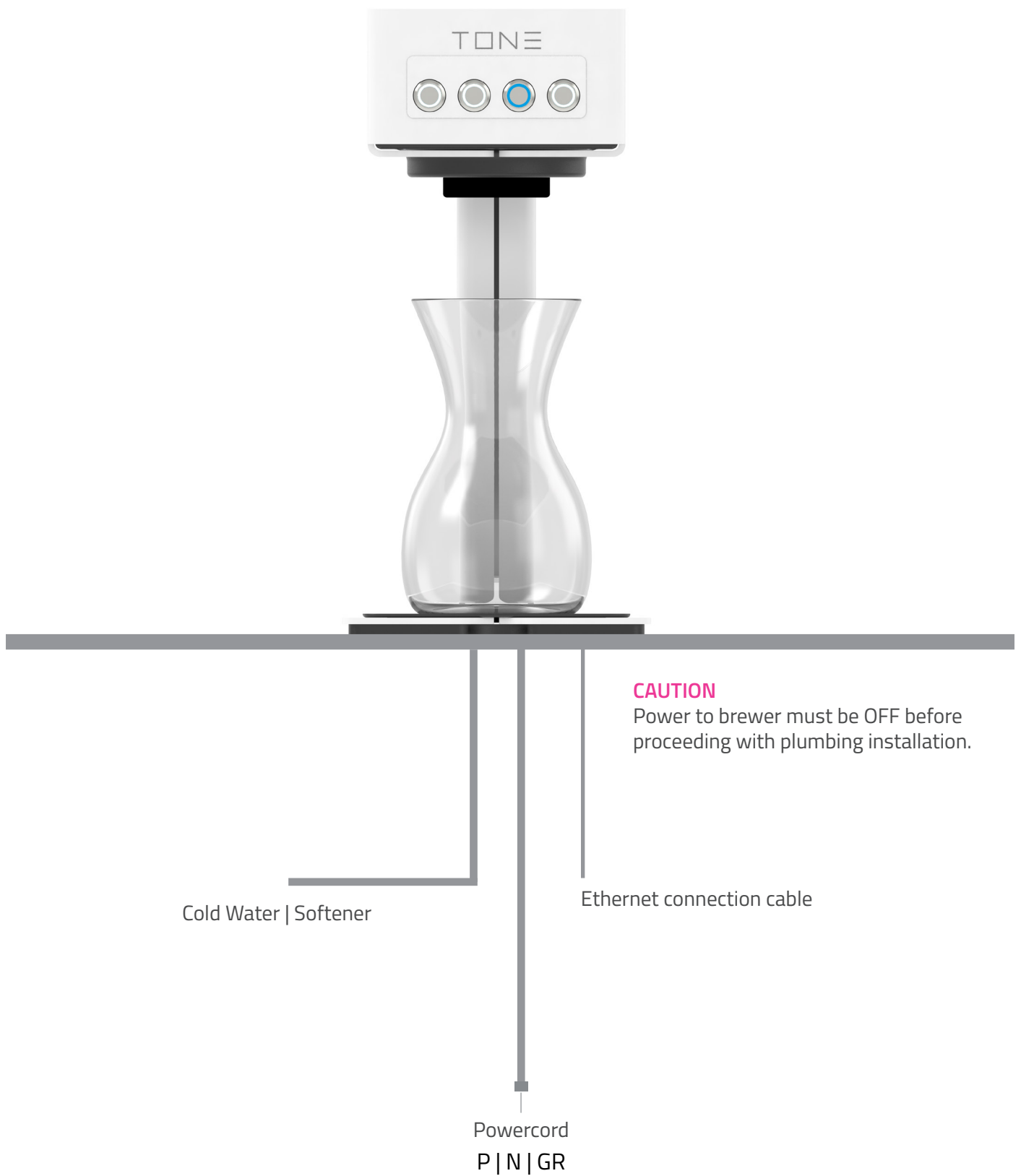

**CAUTION**

Improper electrical installation will damage electronic components.  
Damage caused by incorrect electrical connections is not covered by warranty.

## INSTALLATION INSTRUCTIONS

- Brewer should be installed on a secure, level, surface capable of fully supporting the weight of the brewer, including accessories that may be placed on the brewer (such as coffee decanters, filters, etc.).
- A potable water line (cold water) capable of consistently supplying the minimum flow rate within the noted pressure range is required at the install location.
- A grounded electrical connection to a circuit that meets the electrical specifications of the brewer and is protected by the appropriate size and type of breaker is required.

**CAUTION:**  
**POWER TO BREWER MUST BE OFF BEFORE PROCEEDING WITH PLUMBING INSTALLATION.**

The brewer must be rinsed after being connected to the water supply line. Remaining air in the system will be removed. Otherwise it may lead to malfunctions and noise in the housing. Follow instructions in section **Button functions**.

The pressure of the water line must be within 1.5bar – 3bar.

The installation of a water softening filter system is mandatory for the use of TONE equipment. Any violation of this regulation will lead to a complete loss of any warranty on the complete system.

The brewer has a descaling tracking function available...

**WARNING:**

The brewer must be disconnected from the power source until specified in INITIAL SET-UP.

**CAUTION** – Improper electrical installation will damage electronic components. Damage caused by incorrect electrical connections is not covered by warranty.

An electrician must provide electrical service as specified in conformance with all local, state and federal electrical codes.

Use a voltmeter to check the voltage and color coding of each conductor at the electrical source.

Ensure power switch on rear of brewer is in the off position. Connect brewer to power source and verify voltage. If plumbing has been hooked up, brewer is ready for Initial Set-Up. If not, disconnect brewer from power source.

**WARNING:** Before servicing or opening this device make sure the brewer is disconnected from power by pulling its plug. The service technician has to see the pulled plug during the whole service operation.

This machine is only intended for the use for which it was basically developed. Any other use shall be considered ill-suited and improper. The manufacturer shall not be considered responsible for any damages caused by improper use. The electric safety to the machine is achieved only when the machine is correctly connected to a grounded electric system.

This fundamental requirement shall be assessed by qualified personnel. Manufacturer and installer shall not be held responsible for any damages caused by the lack or inefficiency of system grounding.

Some fundamental rules shall be followed when using any electric appliance:

- Do not use the appliance barefoot or when hands / feet are wet.
- Children shall be supervised and never allowed to play with the appliance.
- Unplug the appliance from the electric system and turn off water supply before carrying out any cleaning and ordinary maintenance.
- Do not put the appliance under a jet of water, nor plunge it into water to clean it.
- Do not leave the appliance turned-on and unattended for long periods (e.g. 1 day)
- In order to ensure the efficiency and correct functioning of the appliance, it is necessary to follow the instructions provided by the manufacturer and to carry out its ordinary maintenance.
- The appliance shall be installed so that the highest surface is at least 1 metre high.
- The appliance shall be placed on a level horizontal surface to ensure a safe use.
- Ideally the appliance is bolted onto the working surface using the included pair of slotted countersunk screws (M10, stainless).
- The temperature range of the environment surrounding the appliance shall be included between 5°C and 30°C. In case the appliance is temporarily placed in an environment where the temperature is below 0°C, contact a local Technical Service authorized by the manufacturer.
- When installing the appliance, use exclusively the current set of functions provided with the appliance itself.
- In case of appliance breakdown and/or malfunctioning, turn the main **switch OFF** and refrain from trying to repair it. Then contact a local Technical Service that has been authorized by the manufacturer.

**WARNING:** Before servicing or opening this device make sure the brewer is disconnected from power by pulling its plug. The service technician has to see the pulled plug during the whole service operation.

If the above-mentioned instructions are not followed, the safety and wear of the appliance can be jeopardized and its guarantee is no longer valid.

This appliance can be used exclusively by skilled professionals. Avoid the use of this appliance by children or unqualified persons. This appliance shall be used only for the use it has been designed for. Any other use shall be considered wrong or unreasonable and therefore the manufacturer shall not be held responsible for any damages caused to persons, animals or things due to a wrong or unreasonable use of this appliance.



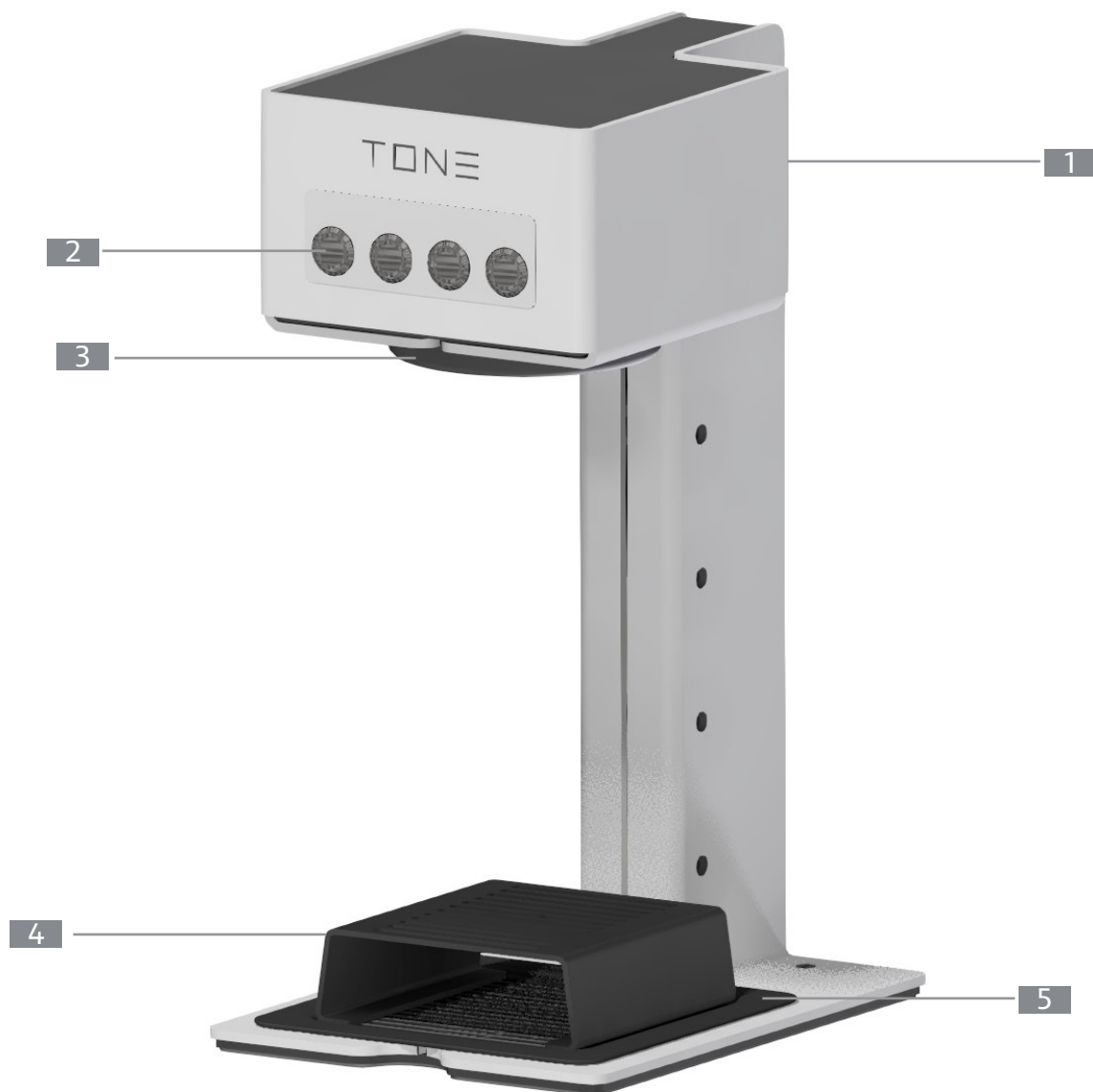

## COMPONENTS TOUCH 03

1 | power switch (on back side)

2 | four programmable buttons for recipe selection

3 | spray head

4 | stand for smaller brewing vessels (option)

5 | drip tray

## Brewing

Equip a brewing vessel of your choice with a filter and fill in an appropriate amount of brewing ingredients.

Place the brewing vessel with loaded filter underneath the spray head and select the desired recipe by pushing the corresponding button. As soon as the program is running the button starts to blink. Be aware that the water flow may be interrupted during the brewing process once or several times. Wait until the recipe is processed completely (button stops to blink).

Remove the brewing vessel from the appliance and the TONE TOUCH 03 is ready for use again immediately. The program can be aborted by pushing the chosen button again during process.

There are four factory standard recipes installed on every TOUCH 03 (from left to right):

- |   |               |               |
|---|---------------|---------------|
| 1 | Volume: 300ml | Taste: mild   |
| 2 | Volume: 300ml | Taste: medium |
| 3 | Volume: 300ml | Taste: bold   |
| 4 | Volume: 300ml | Taste: xbold  |

The recipes can be exchanged or modified by connecting the TONE Tablet PC to the TOUCH 03.

The TONE Tablet pc is an optionally available device, which can be purchased directly from TONE or any qualified service partner. It is also possible to order new settings as a part of a service operation.

Recipe selection: Button 1 – 4 (from left to right)

Descaling: Push and hold Button 1 while switching the main switch ON

Rinsing: Push and hold button 1 & 2 while switching the main switch ON.  
Stop the rinsing by switching the main switch OFF

-> rinse the device after a long-lasting down time or when there may be air inside the system.

-> Before air transport or exposure to temperatures below 4°C all remaining water inside the brewer has to be removed. Disconnect the water supply and start the rinsing procedure. Insert an air-loaded syringe into the waterline and carefully push all remaining water out.

NEVER USE COMPRESSED AIR! This will destroy the sensitive flow meter.



# Connecting the TONE Touch 03

## Option 1 LAN-2-USB Converter

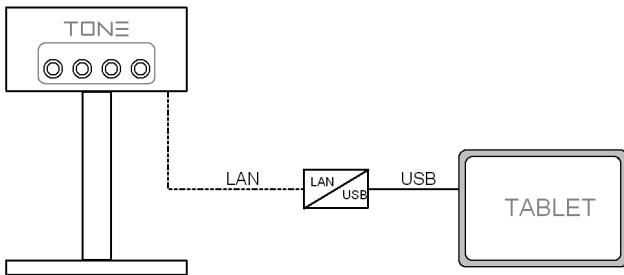

You need a **LAN-2-USB Converter** (#650309) and a **TABLET** computer (#650308)

- > connect the TONE to the **LAN-2-USB** converter
- > connect the **TABLET** to the **LAN-2-USB** converter
- > only one TONE can be connected to the **TABLET**

## Option 2a WiFi-Router

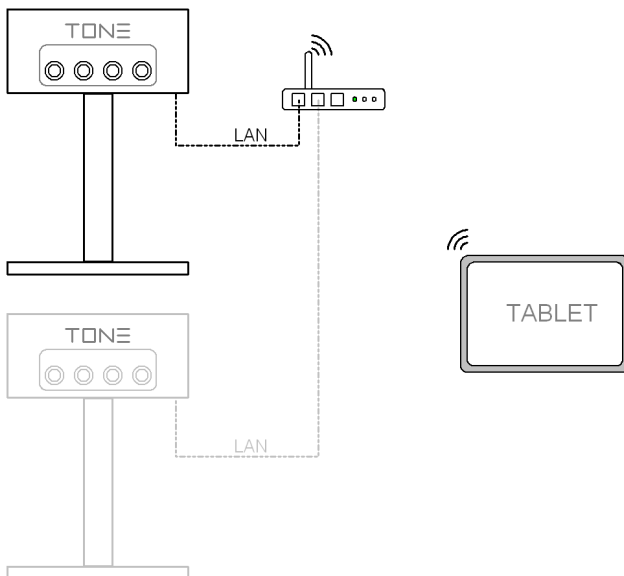

You need a **WiFi router** (#650310) (router pre-configured by TONE) and a **TABLET** computer (#650308)

- > connect the TONE to the **WiFi** router.
- > connect the **TABLET** to the **WiFi** router.
- > you can connect one or more TONE to the tablet.

## Option 2b LAN-switch / LAN-router and LAN-2-USB Converter

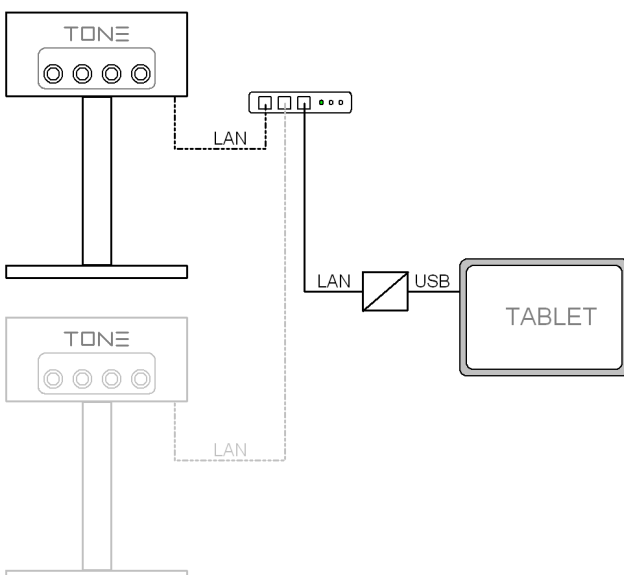

You need a **LAN switch** or **router** (#650310) and a **LAN-2-USB converter** (#650309) (router pre-configured by TONE) and a **TABLET** computer (#650308)

- > connect the TONE to the LAN switch
- > connect the LAN switch to the tablet via a **LAN-2-USB converter**
- > you can connect one or more TONE to the tablet.

### Option 3 Ethernet-2-WiFi Converter

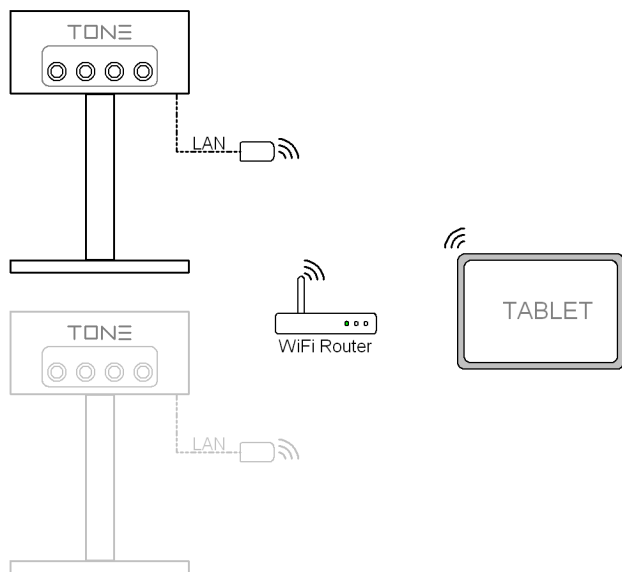

For each TONE you need an **Ethernet-2-WiFi Converter** (#650307)  
(converter pre-configured by TONE)  
a **WiFi Router** (#65310)  
and a **TABLET** computer (#650308)

- > connect the TONE to the **WiFi** router.
- > connect the TABLET to the **WiFi** router.

The password to unlock the tablet is "tone".

#### Configuring of the USB-C adapter (Gigabit Ethernet) for other device than TONE Tablet

1. Connecting the adapter with your device
2. Control panel -> Network and Internet -> Network and Sharing Center -> Change adapter settings -> Ethernet -> Properties
3. Click on Internet **Protocol Version 4 (TCP/IPv4)** -> Properties
4. Select **Use the following IP address:** and enter the following address

IP address: 192.168. 1 . 1  
Subnet mask: 255.255.255. 0  
Default gateway: leave empty

#### IOGear GWU637 Ethernet-2-Wifi

The adapter is preconfigured as follows:

SSID: ToneTouchHotspot  
Encryption: WPA2-PSE(AES)  
Password: tone2020hotspot

Please consider the user manual from IOGear for the configuration to other networks.

Connect your TONETouch03 brewer with the TONE tablet computer as described in the previous section. Once the installation is complete, switch your TONE Touch 03 ON and it will appear in the list of available TONE equipment on the left side of the Touch03 tab. The factory pre-set name will be ToneTouch03\_XXXXX (XXXXX=serial number). This can be customised later (s. Service tab).

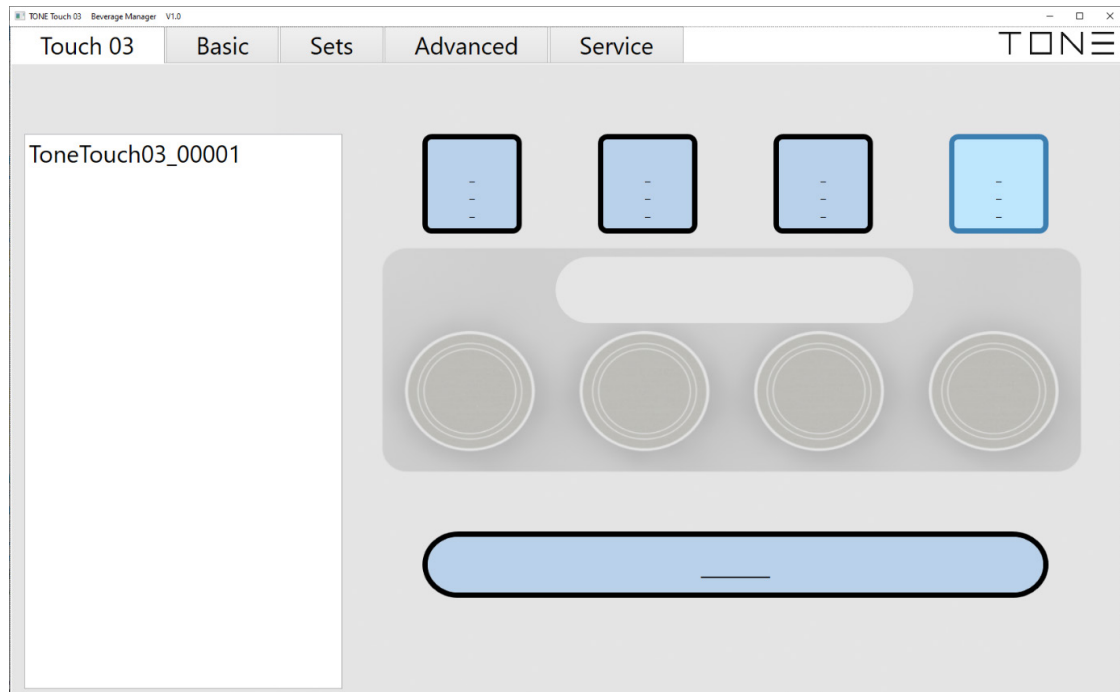

Click on your device in the list and the standard configuration of the recipe selection buttons will be displayed. You can either change this configuration by clicking each button individually and chose recipes from the list which will be explained later. Or you can select a whole set of recipes which you can compose in the **Sets** tab.

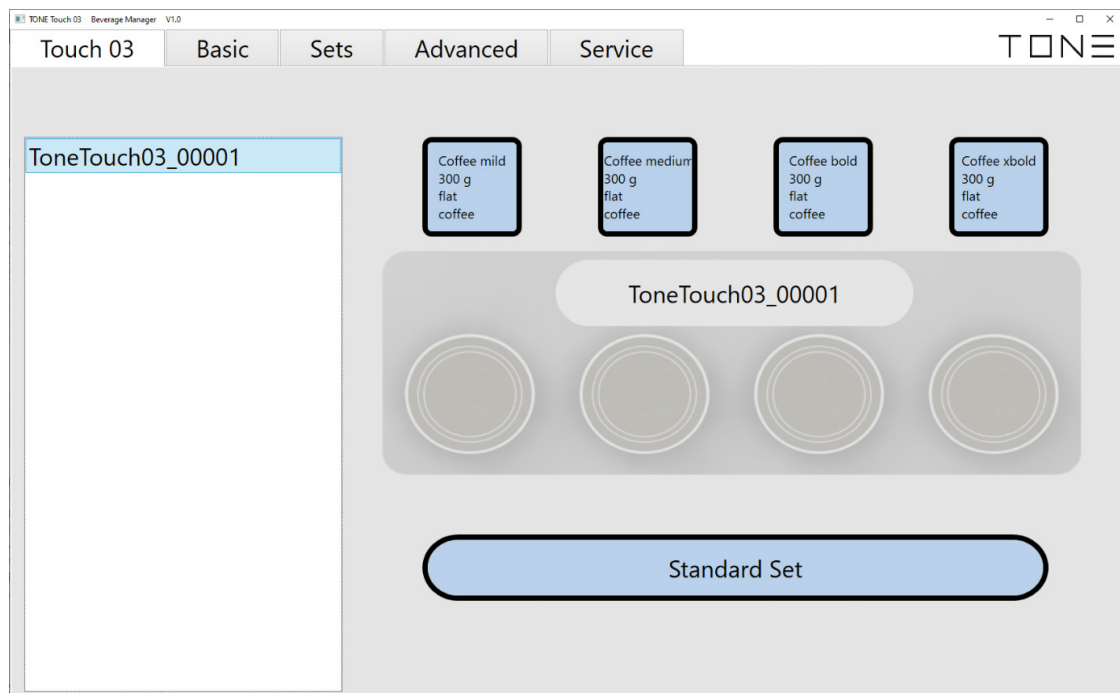

Please remark that your adaptations are made directly on the device. There is no need for a transfer command or a click on a confirmation checkbox here.

The Basic tab provides a tool for a quick and successful recipe creation. There are four pre-set options for coffee and three for tea, which will result in different flavour intensities of the beverage.

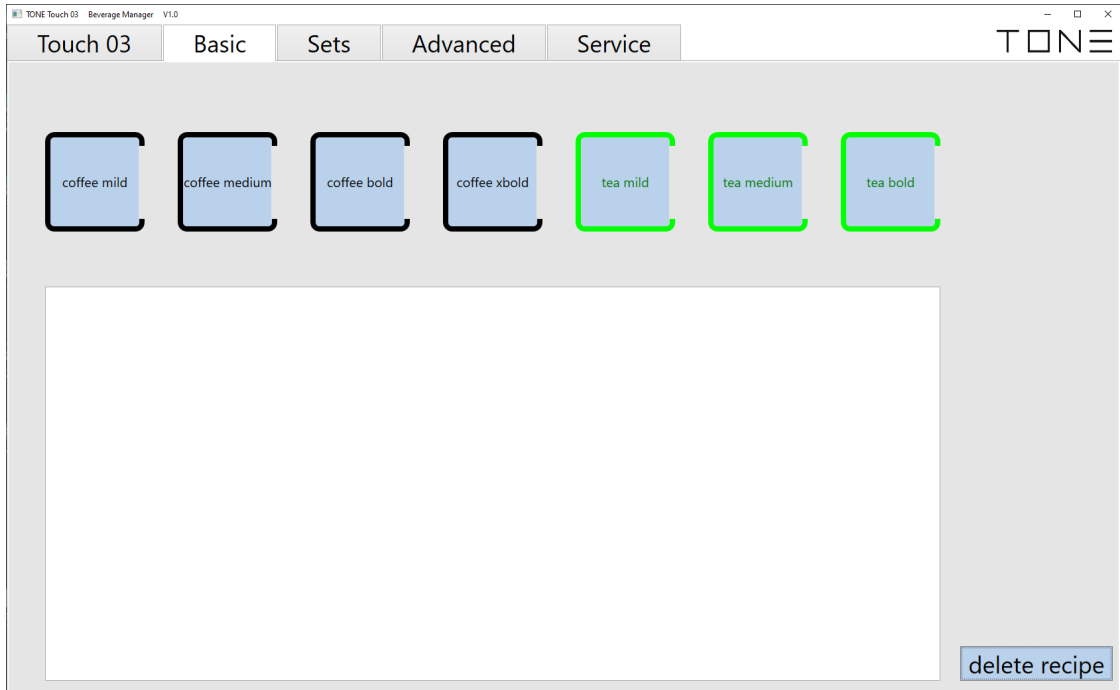

For the coffee recipes, the brewing temperature and the pulsation of the water flow is pre-defined, based on the experience of TONE coffee experts. You can simply adjust the amount of water (click or click and hold on the arrows) and choose between cone and flat filters. Make sure you have installed the correct spray head insert for each filter type. **For the cones you need to install the insert with 5 holes, for the flat filter the insert with 18 holes.**

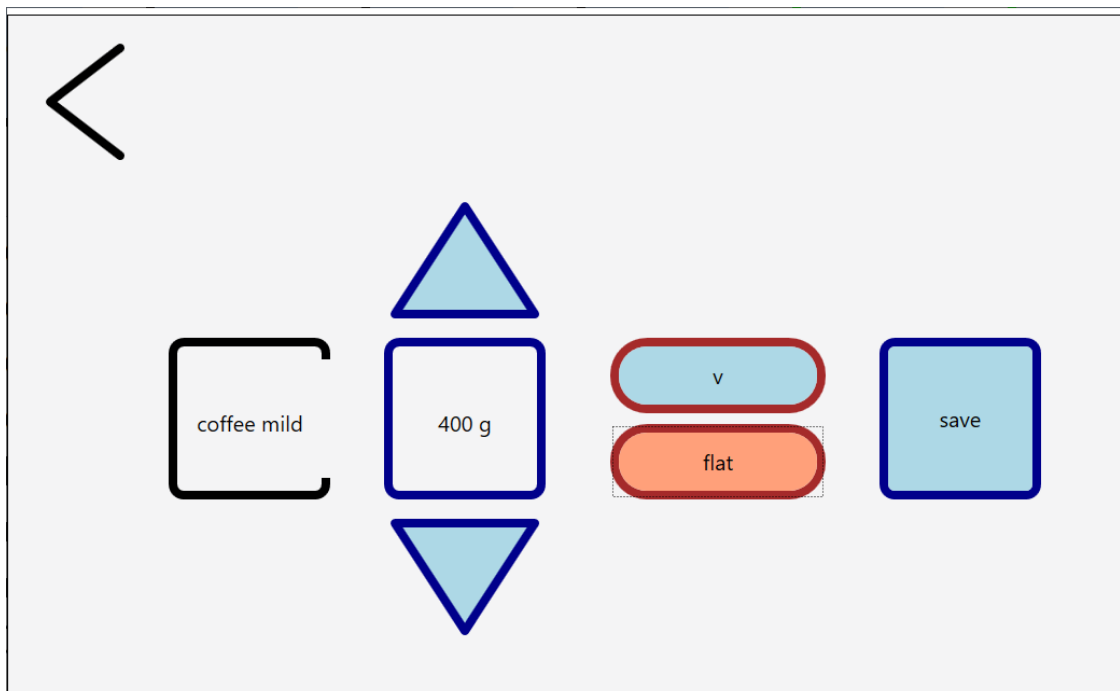

Click on the save button and your recipe will appear on the recipe list.

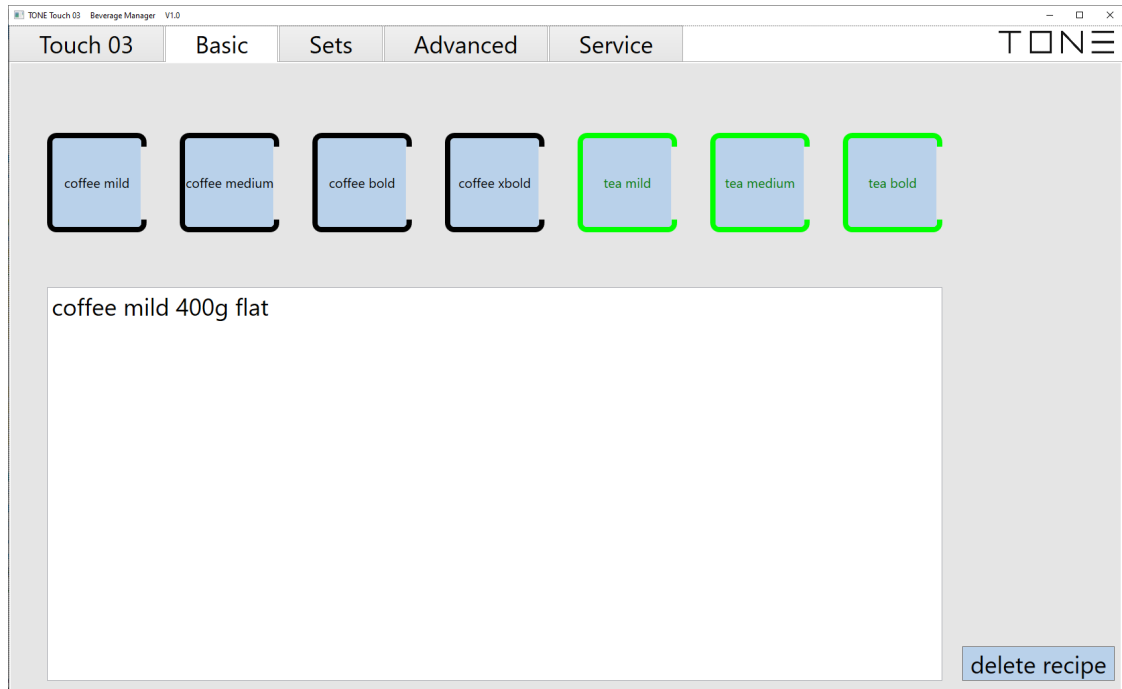

The name of the recipe tells you the strength of the coffee, the amount of water and the applied filter type. The settings of the tea recipes are slightly different. Choose the water temperature considering the type of tea which shall be prepared. The colours of the button frames correspond to the tea types. The different tea options differ regarding the number of pulses and their characteristics.

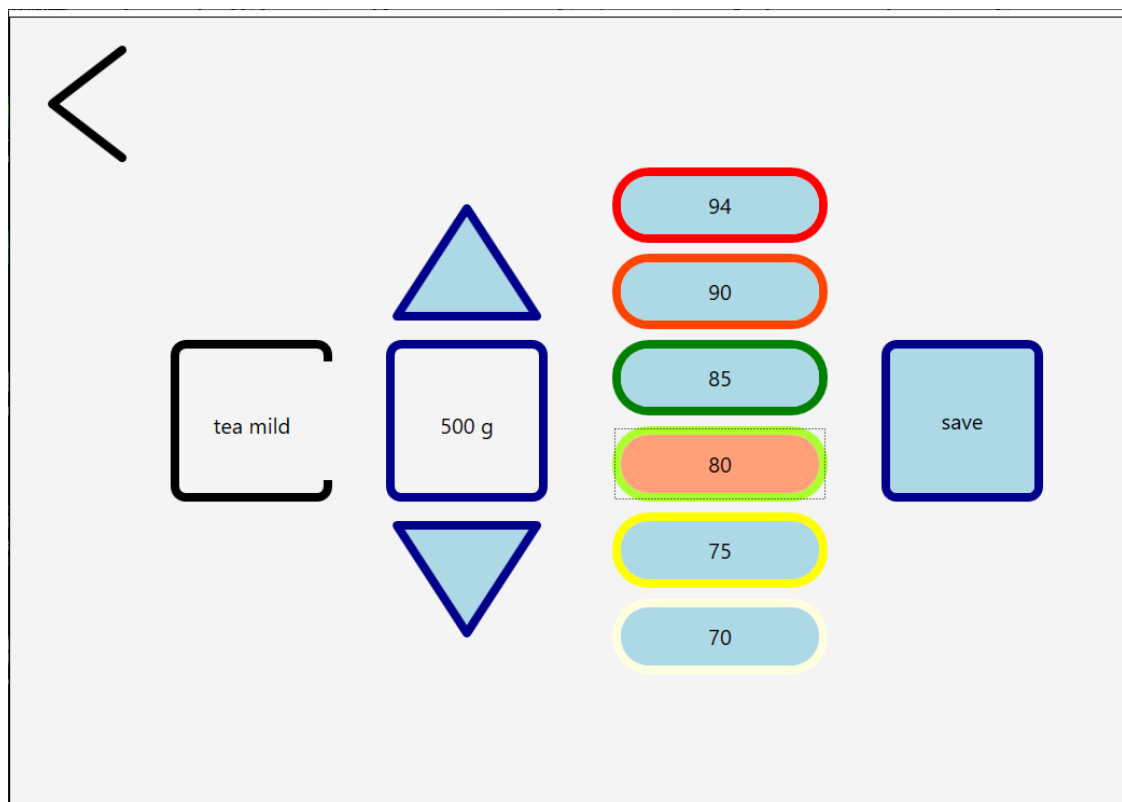



The name of a tea recipe will tell you the strength of the flavour, the amount of water and the brewing temperature.

See below a list of sample recipes for each pre-set button. When a recipe is no longer needed, you can delete it in this window by clicking "delete recipe".

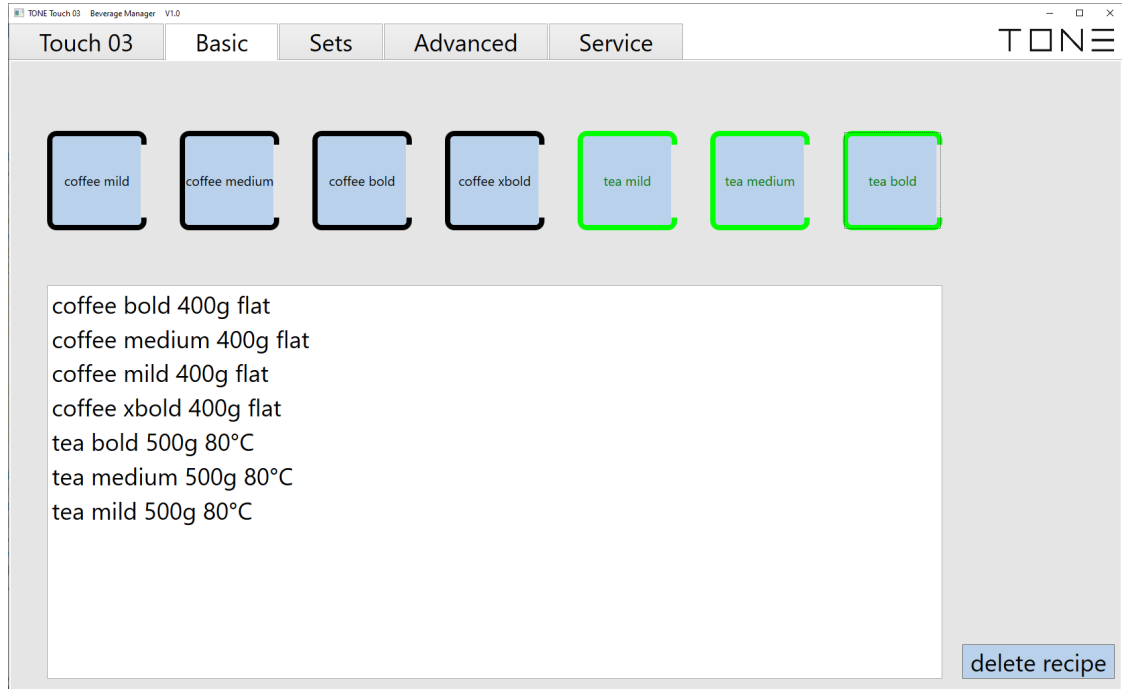

The **Set** tab is empty when used for the first time. You can compose a set of recipes by clicking on each of the four square buttons and choosing a recipe from the list.

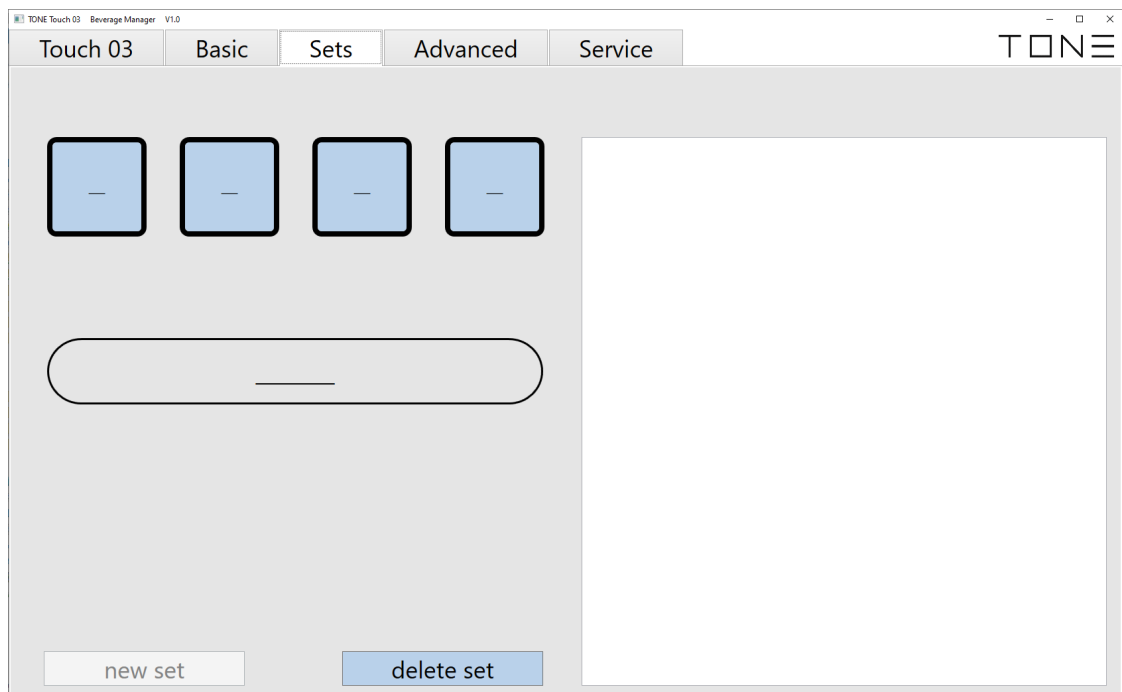

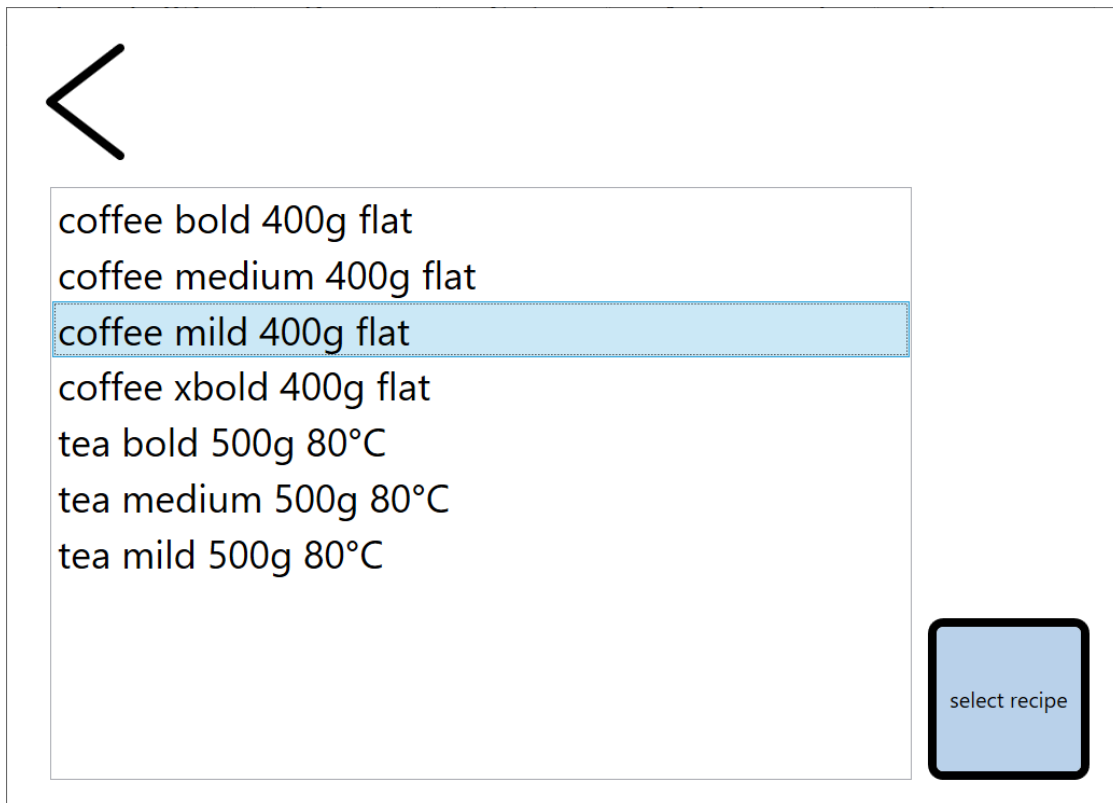

<

- coffee bold 400g flat
- coffee medium 400g flat
- coffee mild 400g flat
- coffee xbold 400g flat
- tea bold 500g 80°C
- tea medium 500g 80°C
- tea mild 500g 80°C

select recipe

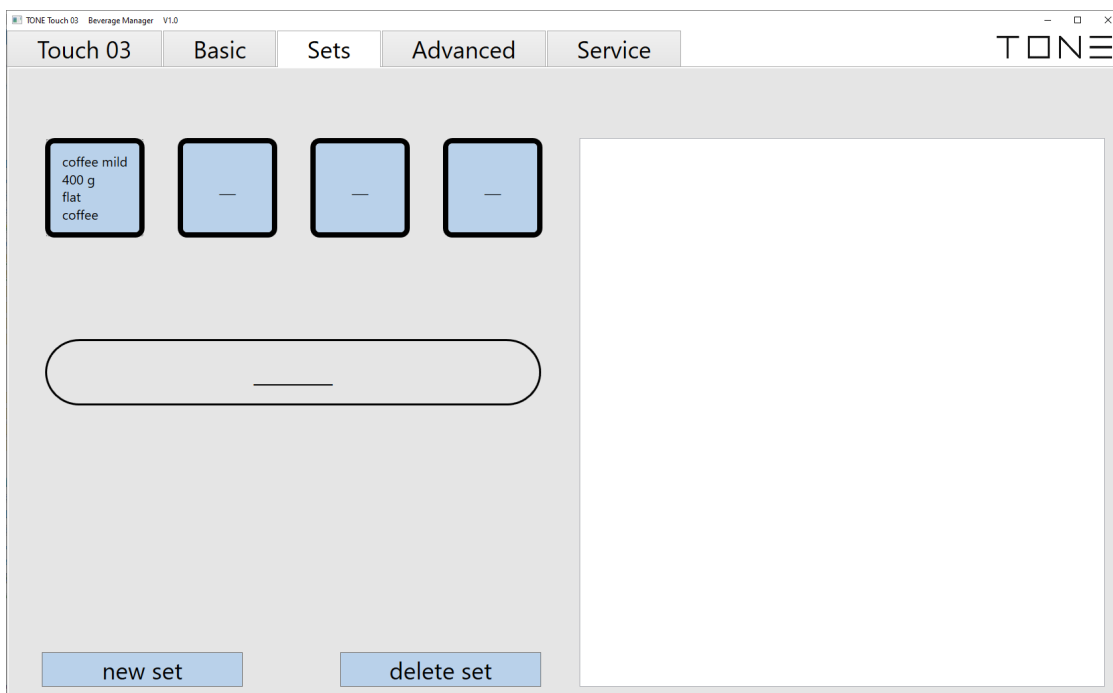

TONE Touch 03 Beverage Manager V1.0

Touch 03 Basic Sets Advanced Service TONE

coffee mild  
400 g  
flat  
coffee

new set delete set

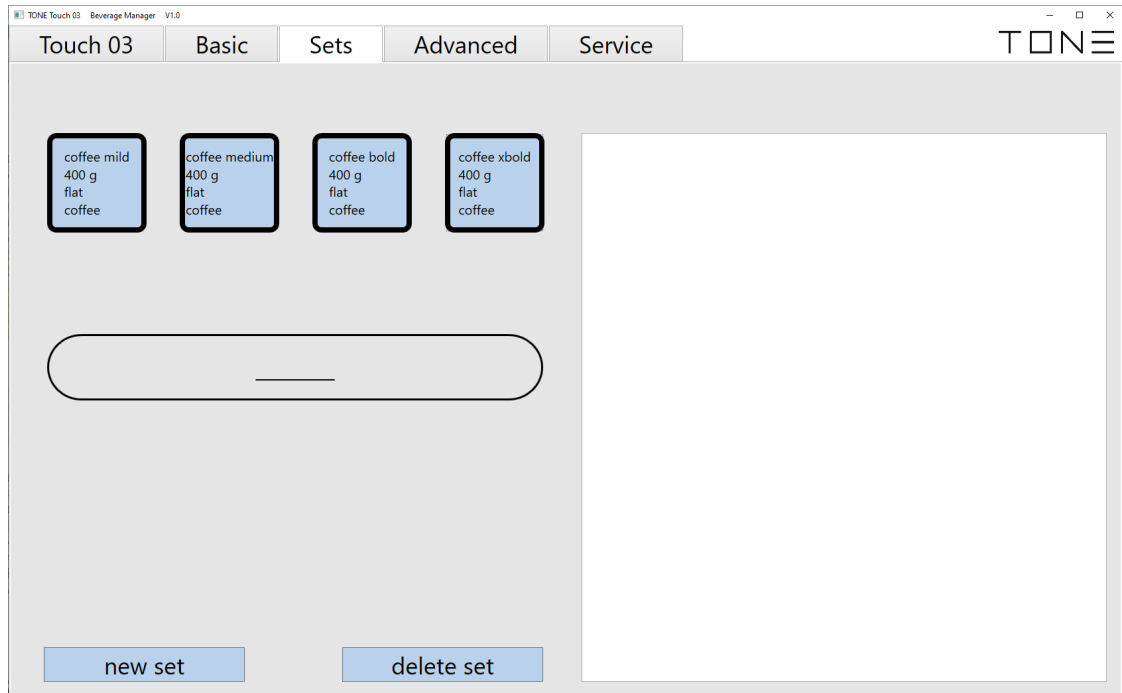

Once you have made your selection of recipes, click on the button “new set” and give it a meaningful name.

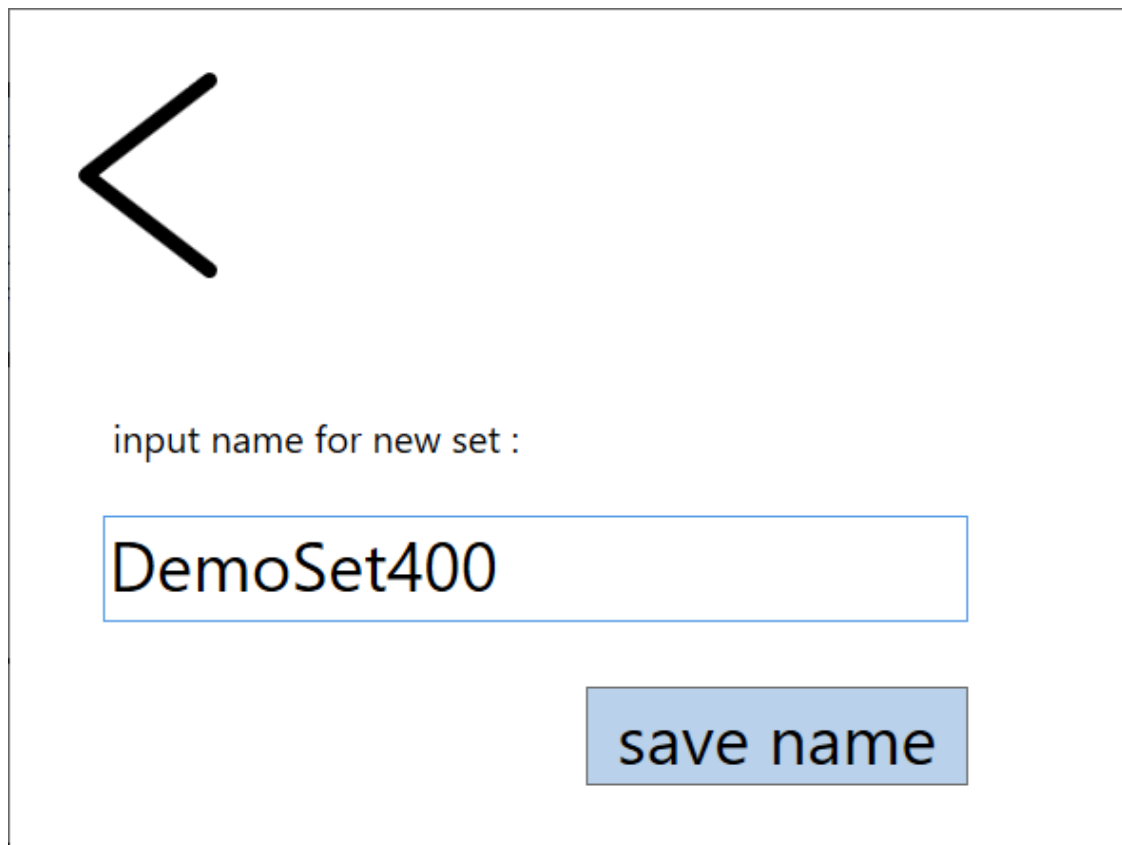

Your set then appears on the set list on the right side of the window. This list will be displayed when you click on the set bar in the Touch 03 tab. Sets which are not needed anymore can be deleted by clicking on “delete set”.

The **Advanced tab** provides you a very intuitive and comprehensive tool for the creation of new recipes. You can set the temperature of each extraction phase (bloom, turbulence, development) and define the characteristics of the water pulses (quantity, flow ratio, duration, interval). Just drag the blue points in the corner of the pulses into the desired position. The current values will be displayed at the top the graphical input screen. Dragging vertically will change the flow ratio. Dragging horizontally affects time-correlated features.



First of all, you should set the water target which you would like to produce. This value will not be exceeded. Varying the bloom or the turbulence phase will adapt the development phase automatically. The development phase itself is self-adjusting between duration and flow ratio of its pulses. Depending on how detailed you would like to compose your recipe, the display resolution can be set 1 or 0.1.

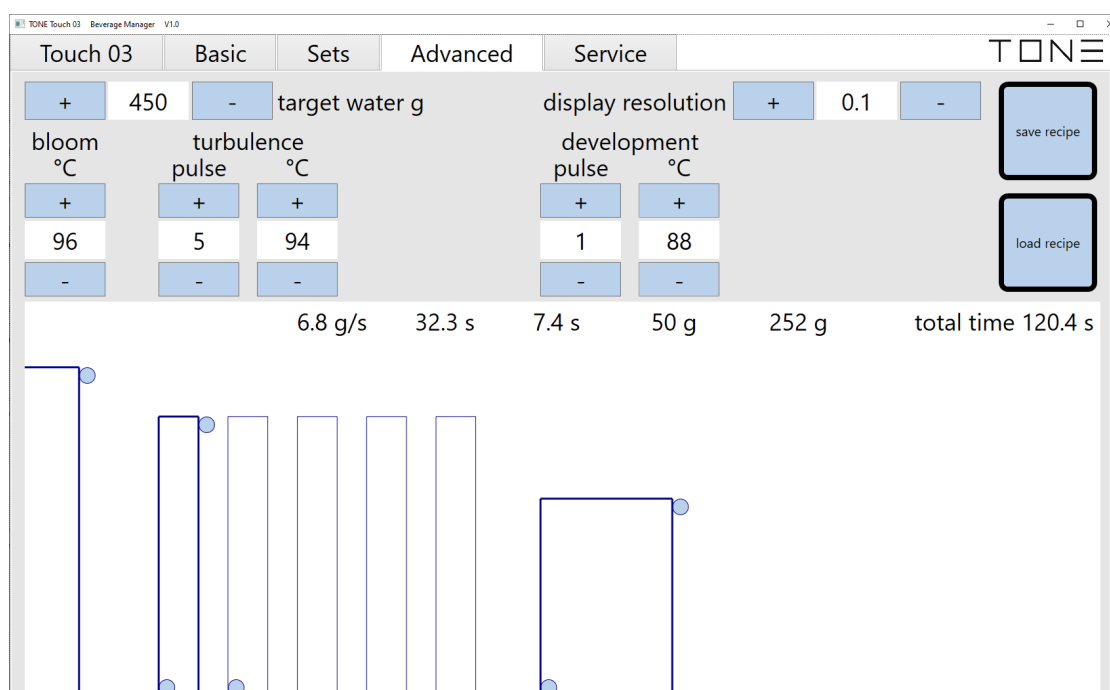

Once you have completed your recipe, you can save it by clicking "save recipe". It will then appear in the selection lists in the Touch 03 and Sets tabs. The name of advanced recipes will be marked with „ad" at the beginning, followed by a description, the weight and the intended filter type. There is also the possibility to change existing advanced recipes by clicking "load recipe".

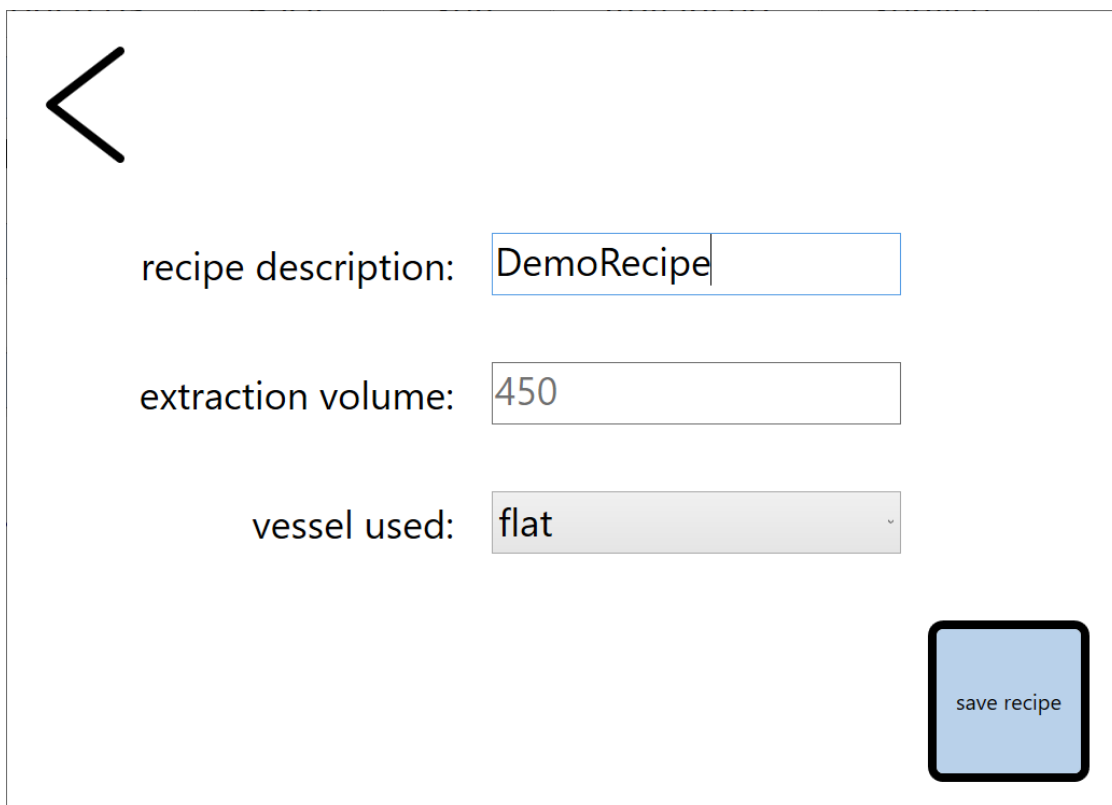

A screenshot of a recipe creation form. In the top-left corner, there is a black left-pointing chevron icon. The form contains three input fields: "recipe description:" with the text "DemoRecipe", "extraction volume:" with the value "450", and "vessel used:" with a dropdown menu showing "flat". A blue button with the text "save recipe" is located in the bottom-right corner of the form.

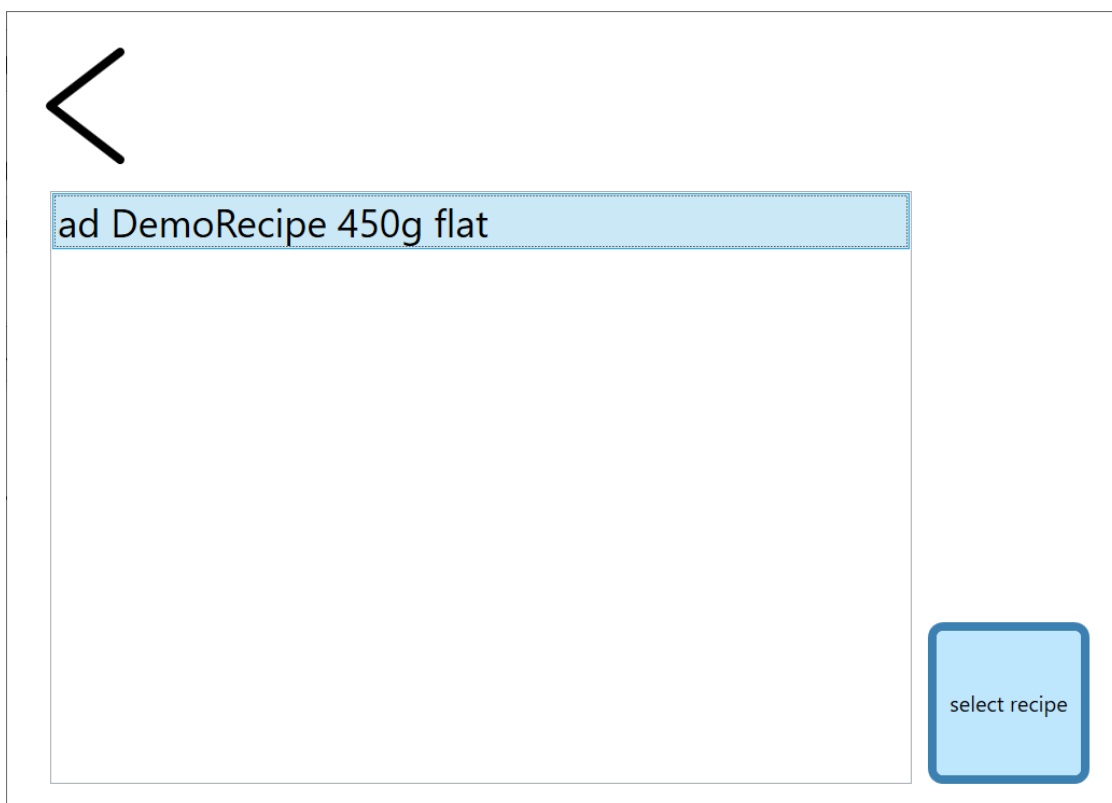

A screenshot of a recipe selection list. In the top-left corner, there is a black left-pointing chevron icon. The list contains one entry: "ad DemoRecipe 450g flat", which is highlighted with a light blue background. A blue button with the text "select recipe" is located in the bottom-right corner of the list.

The **Service tab** provides possibilities to customise the brewer identification and the calibration. And you can also check all important parameters. Clicking on the service tab will automatically open a login pop-up window. Entering the password "TONEservice" enables all available options. Select one of the brewers listed in the left column.

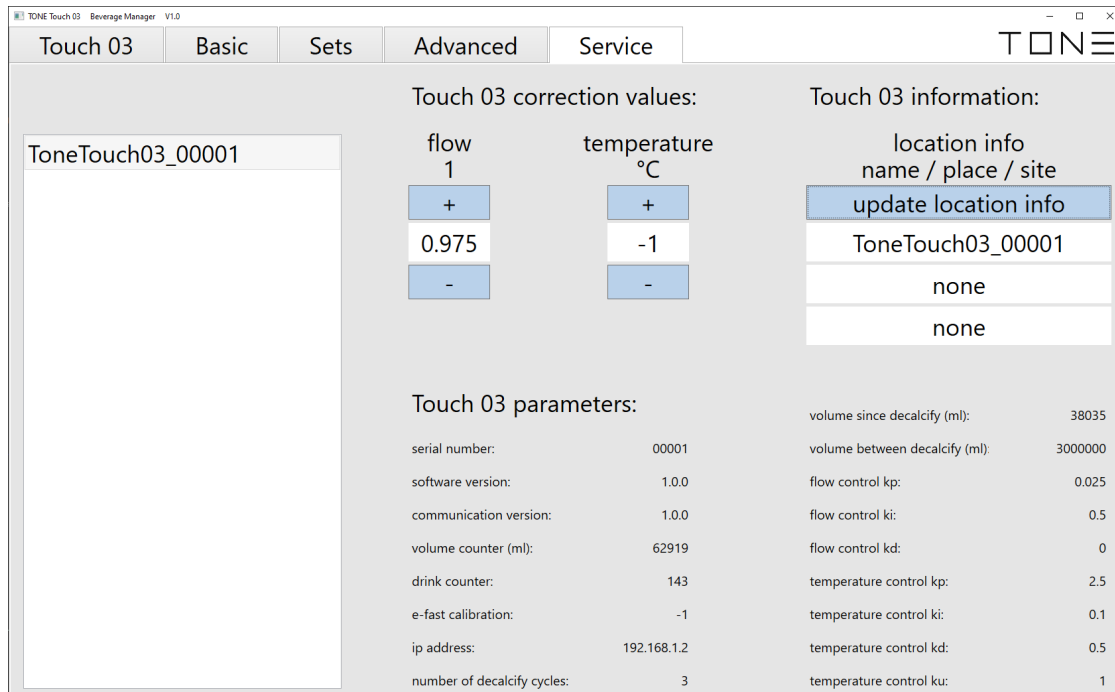

Click on "update location info", enter a meaningful description of your brewer and its location and confirm these entries by clicking "accept".

The dialog box contains the following fields and buttons:

- A back arrow icon in the top left corner.
- A label "name of TONE Touch 03:" followed by a text input field containing "Touch03\_TKM\_Lab06".
- A label "location info place:" followed by a text input field containing "TKM Factory".
- A label "location info site:" followed by a text input field containing "Laboratory No.6".
- An "accept" button at the bottom right.

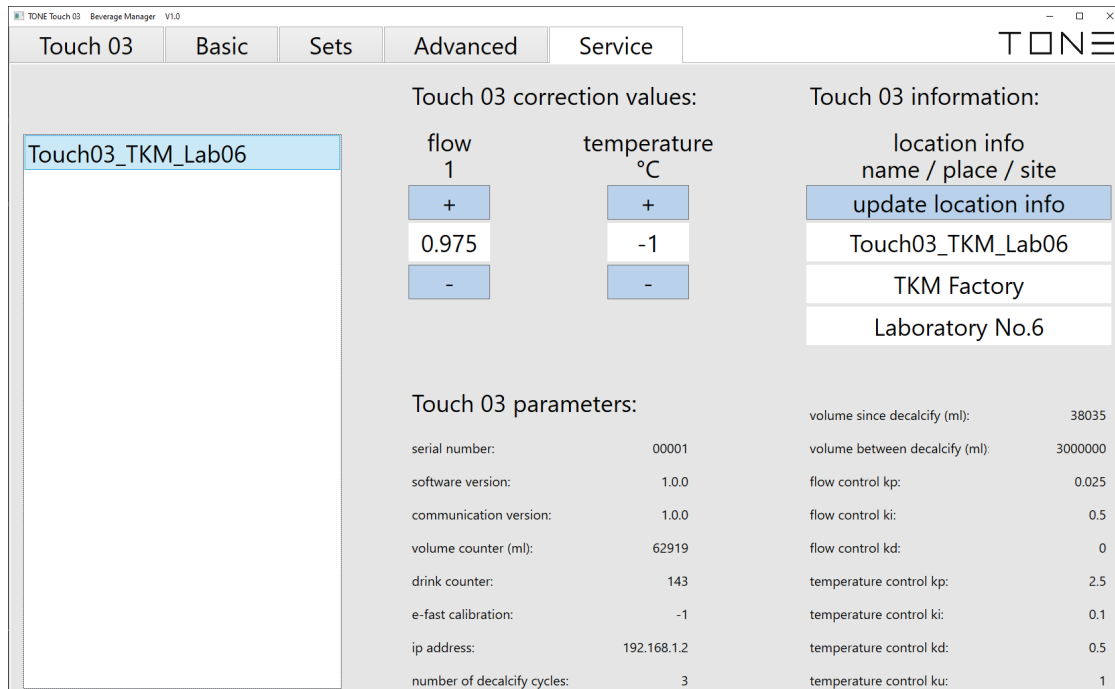

In case your brewer should extract more or less water than intended you can tweak the flow rate by setting a value below 1 in case you want to reduce the amount of water or a value above 1 if you want to increase the amount of water. This is a very sensitive tool and can only be adjusted in permille steps.

In case your extraction temperature doesn't fit to the set values of the recipes (e.g. when there is very cold water supply) you can adjust the temperature by clicking "+" or "-". The maximum values are +5/-5°C. Keep in mind that the maximum possible temperature of a recipe is limited at 98°C. Theoretically you could then achieve a temperature of 103°C. The heating system will then produce steam instead of water, which needs to be prevented in order to achieve good brewing results.

Please also remark that the boiling point of water drops with increasing altitude ( $\approx -1^\circ\text{C}/300\text{m}$ ).

## DAILY CLEANING

To guarantee proper functionality of TONE equipment it is necessary to clean the device on each day it was in use.

To clean the surface of TONE equipment, it is recommended to use a damp cloth and mild customary detergent.

Do not use water jet device to clean the TONE equipment.

Do not use abrasive means to clean the TONE equipment.

Check and clean the spray head daily. All holes of the spray head must always remain open

**NOTE** – Any remains on the spray head may influence the water flow and impact your coffee brewing.

## DESCALING

To guarantee proper functionality of TONE equipment, it is necessary to descale the device.

Descaling of TONE equipment may only be performed by qualified personnel.

The descaling of the TONE Touch 03 brewing system is mandatory after every 3000 litres of water extraction.

Any violation of this regulation will lead to a complete loss of any warranty on the complete system.

The demand of a descaling process is indicated on the recipe buttons by a blue chasing light: -> <- ->.

This signal is shown after switching the machine ON and at the end of every extraction. It will only disappear after a complete descaling process. Before the descaling process is started, a vessel with a minimum volume of 1 litre must be placed underneath the shower. Install the descaling agent container on the machine's inlet.

To begin the descaling, the machine must be switched OFF. Push and hold button 1 while switching the machine ON again. The descaling process starts immediately and will last about 12 minutes. As soon as the descaling is completed, button 1 shines constantly blue. Remove the descaling agent container and restart the machine. Flush the whole system by extracting at least 2 litres of hot water.

The TONE Touch 03 is then ready for the preparation of the next 2998 litres of water.

In case you need support or additional equipment (e.g. descaling agent containers), please contact a local Technical Service that has been authorized by the manufacturer.

---

To find out your local Technical Service visit our website <https://www.tone-swiss.com>



**TONE Kaffeemaschinen AG warrants equipment manufactured by it for 1 year parts and labor.  
Accessories and Dispensers 1 Year parts only.  
Electronic Circuit and Control Boards- 2 years parts, 1 year labor.  
Equipment manufactured by others and distributed by TONE - Please see  
original equipment manufacturers warranty, TONE Kaffeemaschinen AG will follow.**

These warranty periods run from the date of sale TONE Kaffeemaschinen AG warrants that the equipment manufactured by it will be commercially free of defects in material and workmanship existing at the time of manufacture and appearing within the applicable warranty period. This warranty does not apply to any equipment, component or part that was not manufactured by TONE Kaffeemaschinen AG or that, in TONE's judgment, has been affected by misuse, neglect, alteration, improper installation or operation, relocation or reinstallation, improper maintenance or repair, incorrect voltage applied to the unit at any time, damage or casualty. This warranty does not apply to any equipment failures related to poor water quality, excessive lime and chlorine and non periodic cleaning and descaling. Warranty is null and void if muriatic or any other form of hydrochloric acid is used for cleaning or deliming. In addition, this warranty does not apply to replacement of items subject to normal use including but not limited to user replaceable parts such as faucet seat cups, sight gauge tubes, washers, o-rings, tubing, seals and gaskets.

This warranty is conditioned on the Buyer 1) giving TONE Kaffeemaschinen AG prompt notice of any claim to be made under this warranty by telephone at +41 52 620 06 06 or by mail to [contact@tone-swiss.com](mailto:contact@tone-swiss.com); 2) if requested by TONE Kaffeemaschinen AG, shipping the defective equipment prepaid to an authorized TONE Kaffeemaschinen AG service location; and 3) receiving prior authorization from TONE Kaffeemaschinen AG that the defective equipment is under warranty.

THE FOREGOING WARRANTY IS EXCLUSIVE AND IS IN LIEU OF ANY OTHER WARRANTY, WRITTEN OR ORAL, EXPRESS OR IMPLIED, INCLUDING, BUT NOT LIMITED TO, ANY IMPLIED WARRANTY OF EITHER MERCHANTABILITY OR FITNESS FOR A PARTICULAR PURPOSE. The agents, dealers or employees of TONE Kaffeemaschinen AG are not authorized to make modifications to this warranty or to make additional warranties that are binding on TONE Kaffeemaschinen AG. Accordingly, statements by such individuals, whether oral or written, do not constitute warranties and should not be relied upon.

If TONE Kaffeemaschinen AG determines in its sole discretion that the equipment does not conform to the warranty, TONE Kaffeemaschinen AG, at its exclusive option while the equipment is under warranty, shall either 1) provide at no charge replacement parts and/or labor (during the applicable parts and labor warranty periods specified above) to repair the defective components, provided that this repair is done by a TONE Kaffeemaschinen AG Authorized Service Representative; or 2) shall replace the equipment or refund the purchase price for the equipment.

THE BUYER'S REMEDY AGAINST TONE KAFFEEMASCHINEN AG FOR THE BREACH OF ANY OBLIGATION ARISING OUT OF THE SALE OF THIS EQUIPMENT, WHETHER DERIVED FROM WARRANTY OR OTHERWISE, SHALL BE LIMITED, AT TONE KAFFEEMASCHINEN AG'S SOLE OPTION AS SPECIFIED HEREIN, TO REPAIR, REPLACEMENT OR REFUND.

In no event shall TONE Kaffeemaschinen AG be liable for any other damage or loss, including, but not limited to, lost profits, lost sales, loss of use of equipment, claims of Buyer's customers, cost of capital, cost of down time, cost of substitute equipment, facilities or services, or any other special, incidental or consequential damages.

## WIRING DIAGRAM

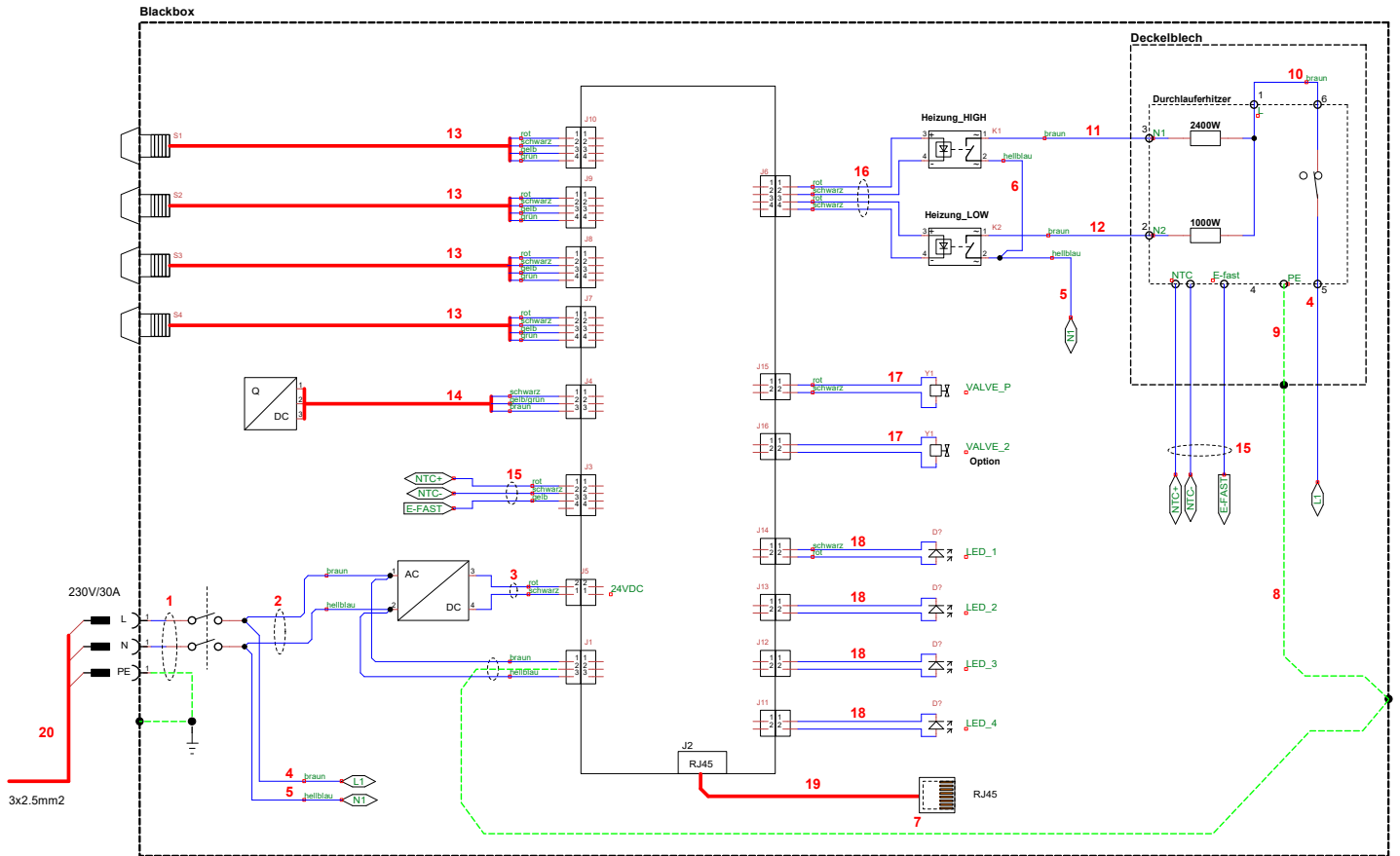

## TECHNICAL DATA

Type	TOUCH 03
Dimensions in mm (w x h x d)	242 x 505 x 324
Weight	22 kg
Power	~ 220 - 240V   50/60Hz
Boilervolume	boilerless
Maximal waterflow	8g/sek
Heating	3450W
Required water pressure	1.5 - 3 bar
Noise level	< 50 dB

### EEC CONFORMITY DECLARATION ACT 2006/42/EC

The undersigned: TONE Kaffeemaschinen AG  
With premises at: Rheinweg 4, 8200 Schaffhausen, Switzerland

#### Declares that:

The coffee machine has been projected and manufactured in conformity with Directive 2006/42/EC and relevant national law, in accordance with the following norm for conformity evaluation: UNI 9887, ISPSEL rev. 95.



### INFORMATION FOR CORRECT DISPOSAL OF THE PRODUCT IN ACCORDANCE WITH EC DIRECTIVE 2012/19/EU

This product must not be disposed of as urban waste at the end of its working life. It must be taken to a special waste collection centre licensed by local authorities or to a dealer providing this service. Separate disposal of the product will avoid possible negative consequences for the environment and for health resulting from inappropriate disposal, and will enable the constituent materials to be recovered, with significant savings in energy and resources.

#### get in TOUCH:

TONE Kaffeemaschinen AG  
Rheinweg 4  
8200 Schaffhausen  
Switzerland

+41 52 620 06 06  
contact@tone-swiss.com

**TONE technical service:** (CET /UTC+1)  
service@tone-swiss.com

# TONE

---

TONE Kaffeemaschinen AG  
Rheinweg 4  
8200 Schaffhausen  
Switzerland

+41 52 620 06 06  
[contact@tone-swiss.com](mailto:contact@tone-swiss.com)  
[www.tone-swiss.com](http://www.tone-swiss.com)

