

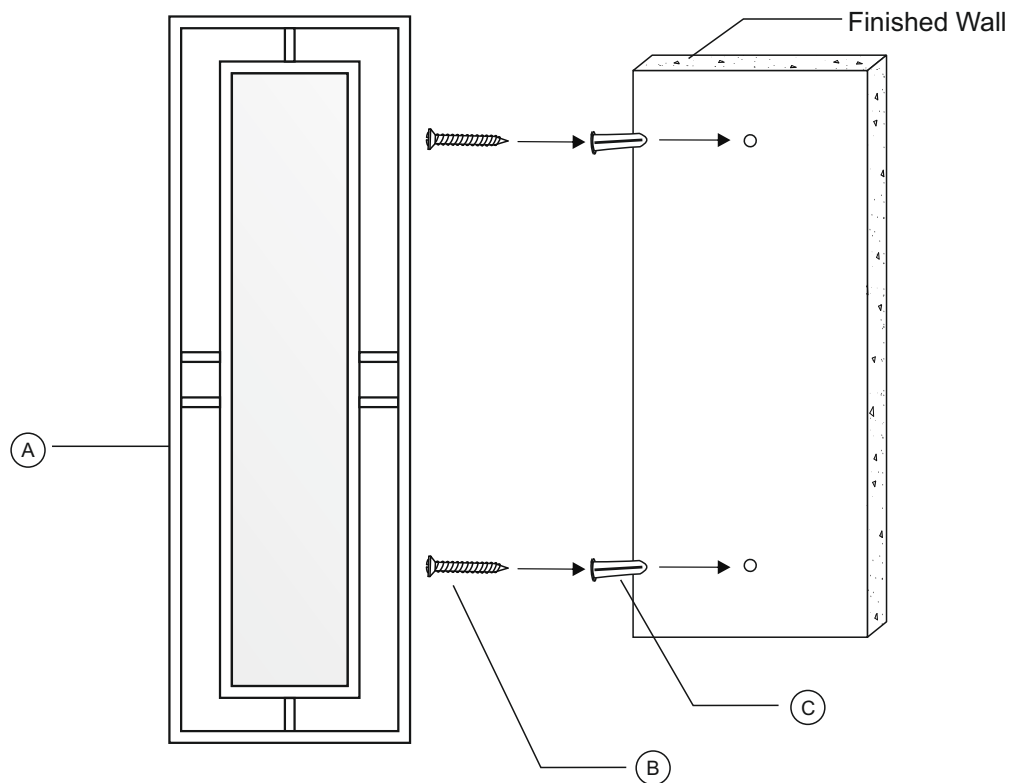





### INSTALLATION INSTRUCTIONS



#### PARTS

A			Mirror	1
B			Anchors screws (Hardware Bag)	2
C			Anchors (Hardware Bag)	2

Please check packaging for all parts and hardware before discarding. Unpack and lay parts on a clean, padded surface like carpet or blanket. Check that you have all parts indicated. Before beginning assembly, carefully study the diagrams below and sort your hardware according to the pictures. Using the incorrect hardware will cause damage.



Find a desired location and mark locations for screws on the wall.

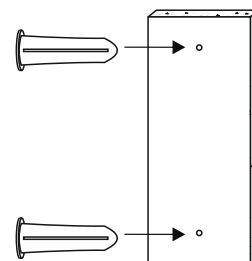

Place anchors on the wall on the marked points . All anchors screws must be attached directly into a anchors.

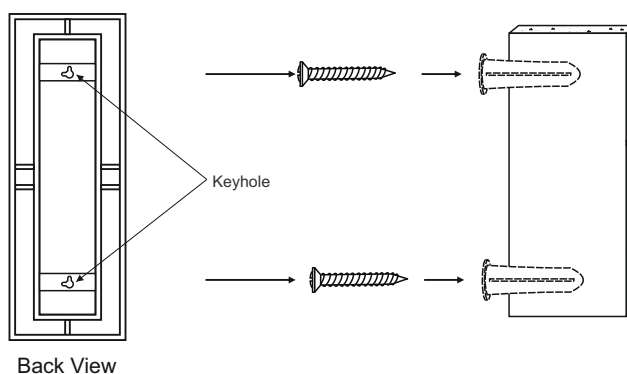

Hang mirror onto the screws and verify the brackets are resting securely on the mounting screws. Now your product is ready for use.

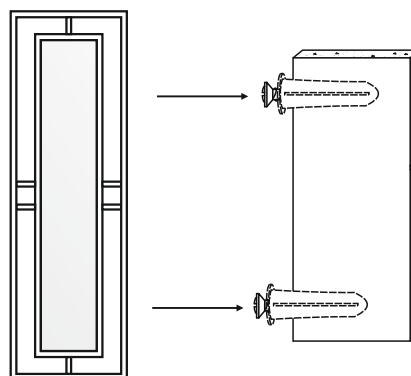

### **IMPORTANT SAFETY INSTRUCTIONS**

1. Professional installation is strongly recommended.
2. For your safety, it is recommended that two people hang the fixture.
3. These instructions are provided for your safety. It is important that they are read carefully and completely before installing the fixture.
4. It is imperative that the wall mirror is mounted into a anchors.

### **CARE INSTRUCTIONS**

1. To clean, use a soft dry or damp cloth.
2. Do not use abrasive cleaners.