

**STEP 3 Connect the Connector to Canopy** : Connect the male part of the connector to the main wire of chandelier. Attach the brown colored wire to phase, blue colored wire to neutral and green yellow colored wire to earth.

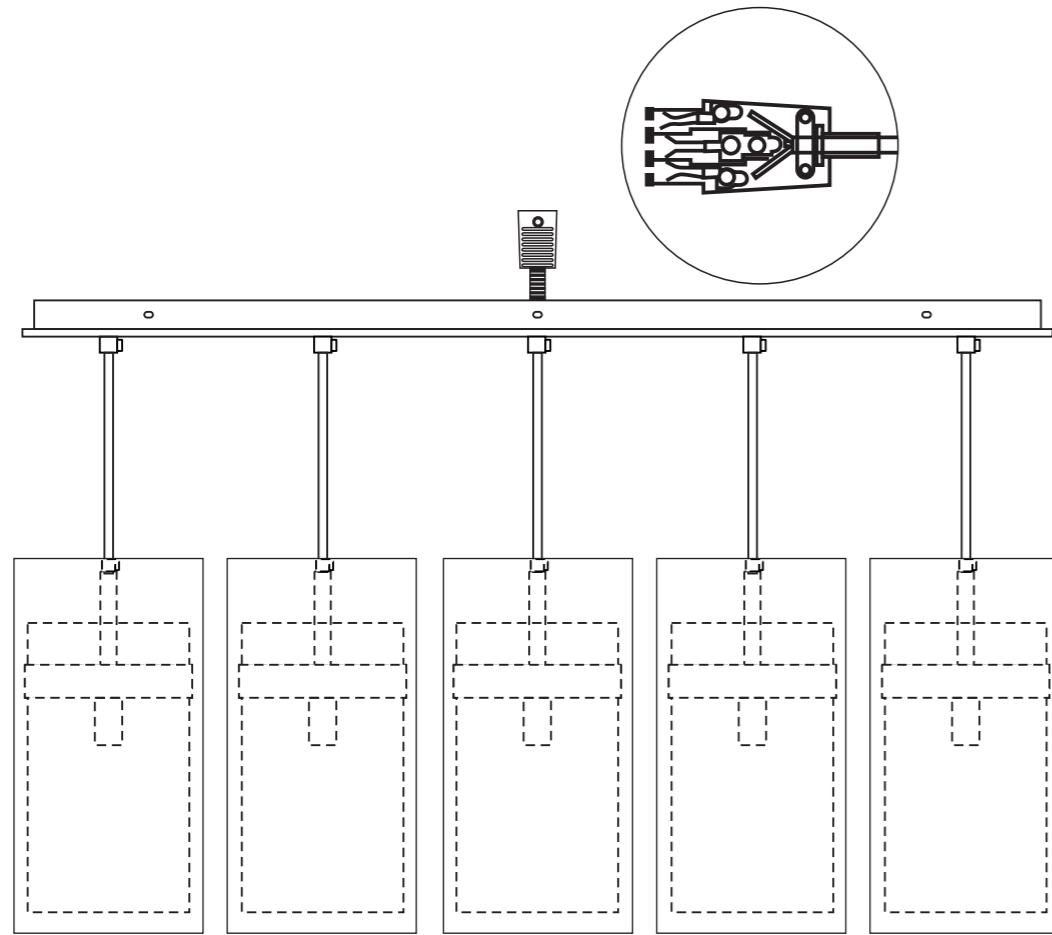

**STEP 4 Connect the Connector** : With the help of another person to hold the weight of the canopy. Join the female part of connector to the male part of connector.

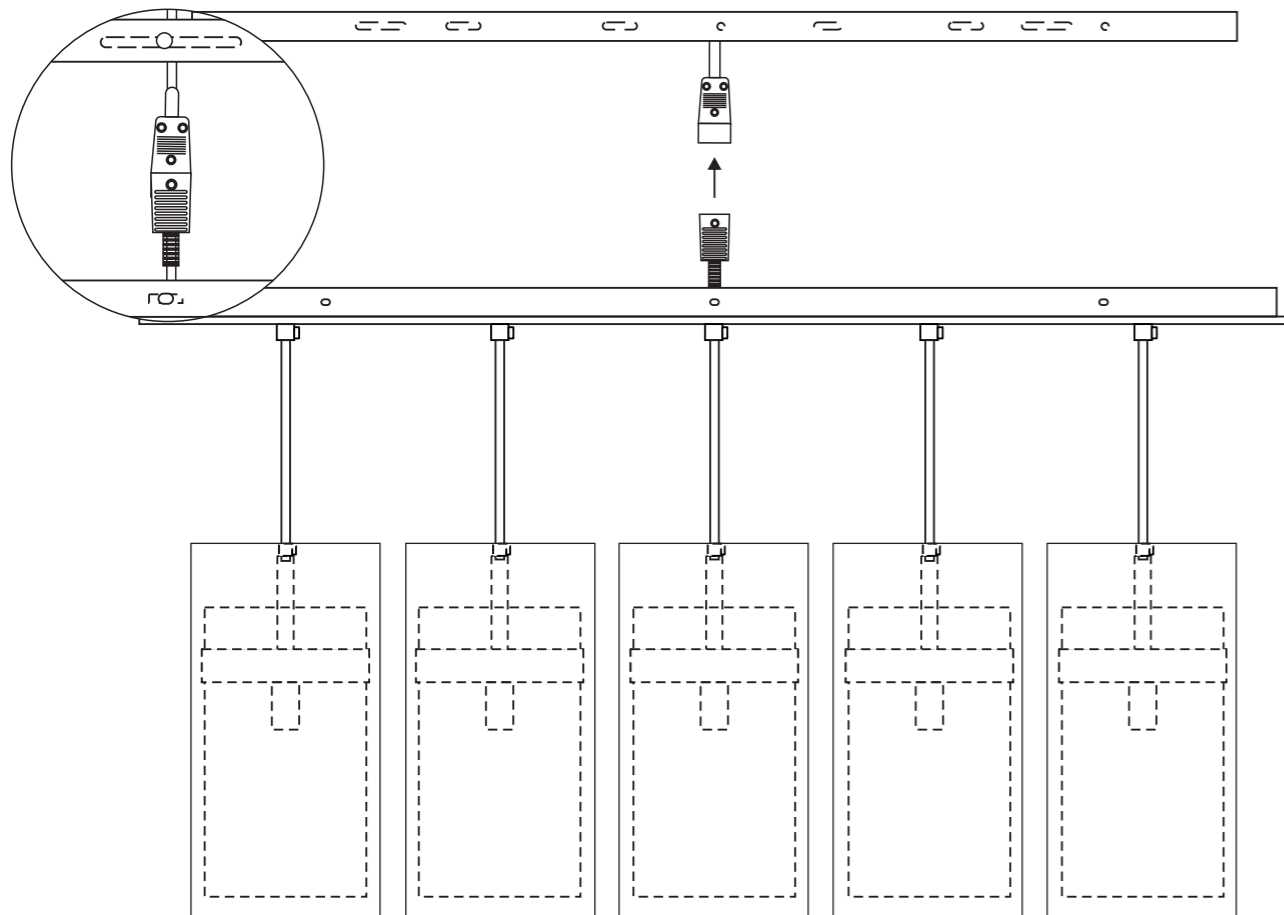

## Assembly and Installation Instructions

### Caution :

- DO NOT ASSEMBLE THE GLASS SHADE BEFORE MOUNT THE CANOPY TO THE CEILING.
- BEFORE INSTALLING FIXTURE, MAKE SURE THE POWER TO THE CIRCUIT IS TURNED OFF AT THE MAIN FUSE BOX / CIRCUIT BREAKER UTILITY BOX.
- DO NOT INSTALL INTO A CEILING THAT CONTAINS RADIANT HEATING.

### Important Safety Instructions :

- The ceiling fastener / threaded bolt are meant for drywall ceiling mounting only.
- The installation is not to be made on a radiant-heating ceiling.
- These instructions are provided for your safety. It is very important that they are read carefully and completely before beginning the assembly and installation of this lighting fixture.
- We strongly recommend that a professional electrician install all direct wire fixtures.
- This product must be installed in accordance with the applicable installation codes by a person familiar with construction and operation of the product and the hazards involved.
- The lighting fixture is meant for indoor use, dry locations only. It must be connected only to 3-wire, single-phase electrical supply systems (provided with Ground wire or equivalent protection system).
- For your safety, it is strongly recommended that three people install the lighting fixture.
- To avoid the risk of fire, do not exceed the recommended wattage.
- **Save these instructions.**



















### Warning :

- To reduce the risk of fire, electrical shock or personal injury, always turn off light fixture and allow it to cool prior to replacing light bulb.
- Do not touch bulb when fixture is turned on. Do not look directly at lit bulb.
- Keep flammable materials away from lit bulb.

### Pre-assembly :

- Remove all parts and hardware from box along with any plastic protective packaging.
- Do not discard any contents until after assembly is complete to avoid accidentally discarding small parts or hardware.
- For your safety and convenience, assembly by three people is recommended.
- The glass mold should not be removed before installation.

**Parts Included :**

|   |   |   |                                 |     |
|---|---|---|---------------------------------|-----|
| A |  |  | Fastener<br>(Hardware Bag)      | 2   |
| B |  |  | Threaded Bolt<br>(Hardware Bag) | 2   |
| C |  |  | Screw                           | 6+1 |
| D |  |  | Allen Key<br>(Hardware Bag)     | 1   |
| E |  |  | Cord Grip                       | 5   |
| F |  |  | Connector                       | 1   |
| G |  |  | Mounting Plate                  | 1   |
| H |  |  | Ceiling Canopy                  | 1   |
| I |  |  | Metal Frame                     | 5   |

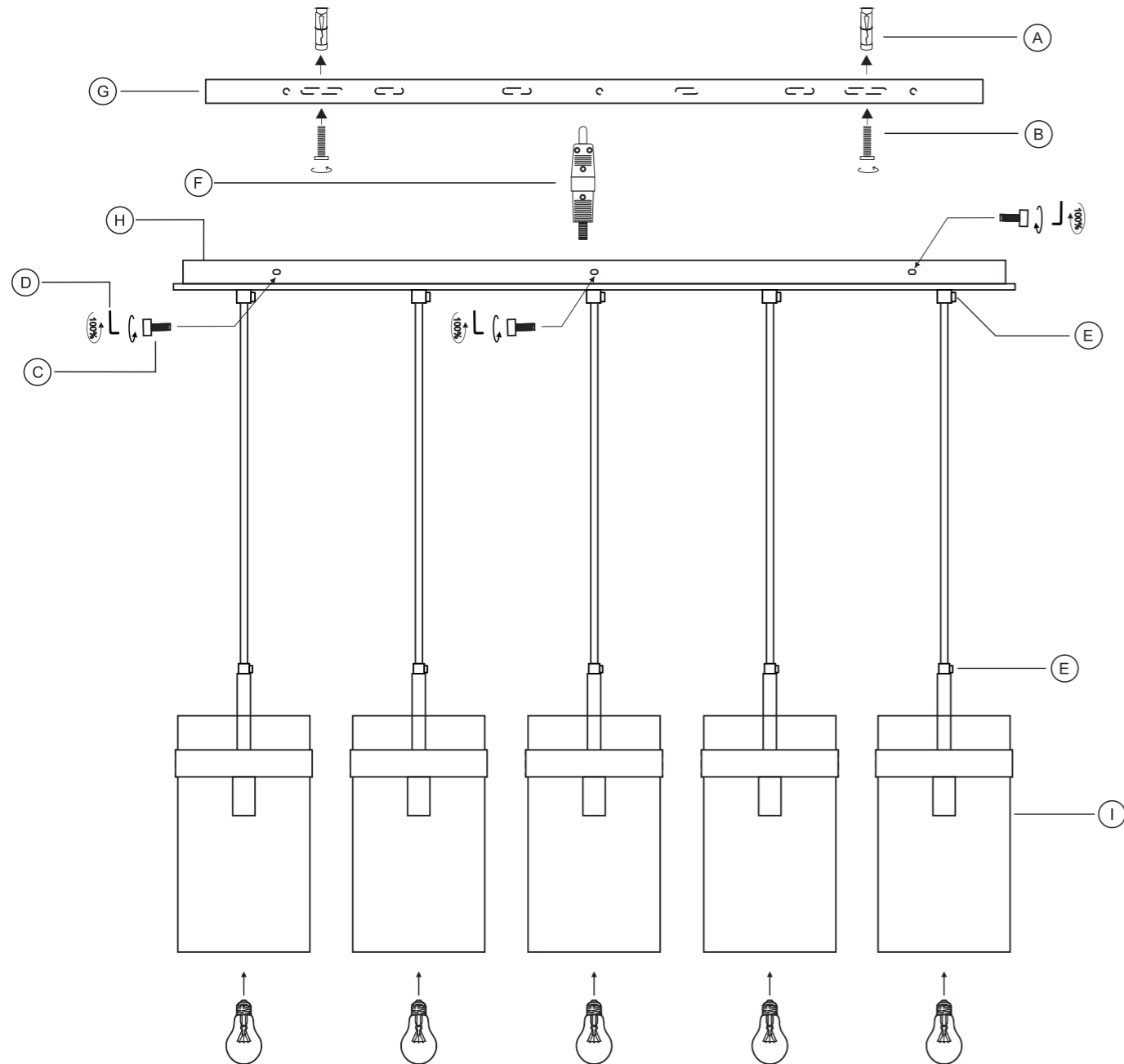

**Assembly and Installation Instructions :**

SHUT OFF THE MAIN ELECTRICAL SUPPLY FROM THE MAIN FUSE BOX/CIRCUIT BREAKER!  
Carefully unpack all fixture parts and hardware and lay out them on a clear workspace.

**STEP 1 Unscrew Mounting Plate :** Disassemble the mounting plate from the ceiling canopy as shown below, with the hardware provided.

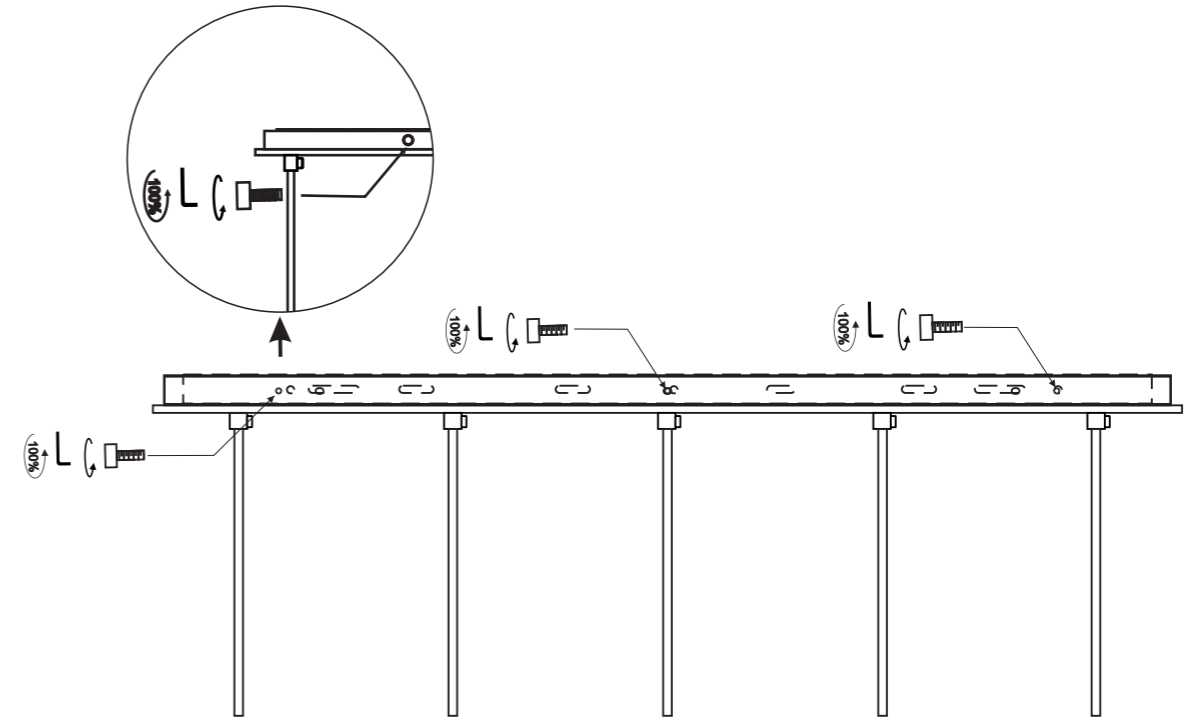

**STEP 2 Installation Mounting Plate :** Install the mounting plate to the ceiling using the fastener. Align with the three holes of the of the ceiling. Tighten the threaded bolt. Take out the main wire through the mounting plate. Connect the female part of the connector to the main supply wire. Attach the brown colored wire to phase, blue colored wire to neutral and green yellow colored wire to earth.

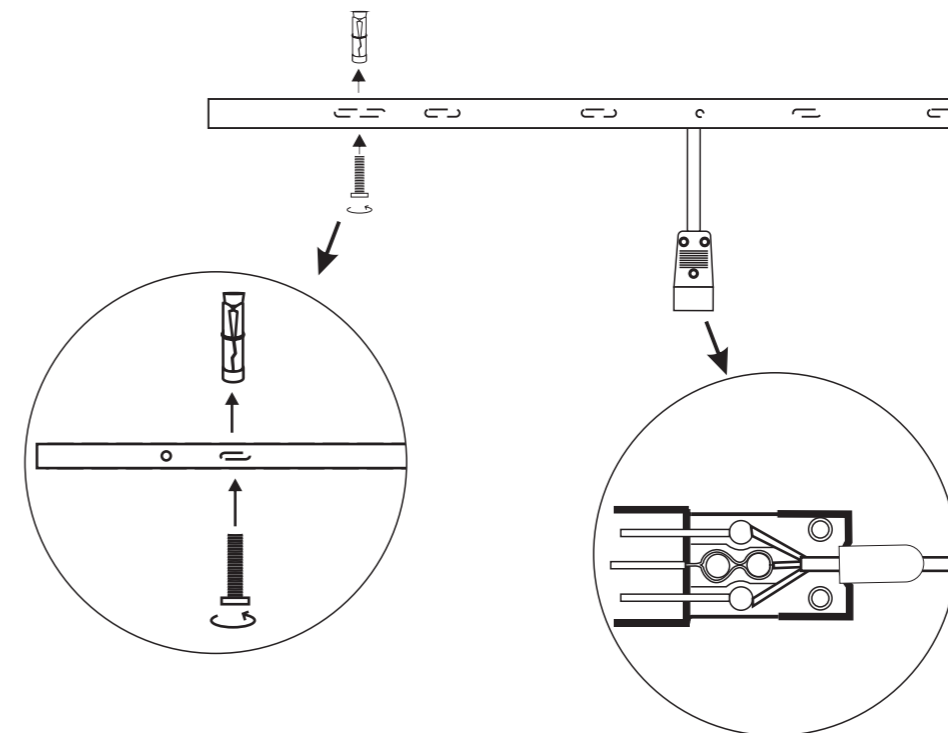

**STEP 5 Mount the Ceiling Canopy :** Fix the canopy to the mounting plate as shown below, and tighten with hardware provided.

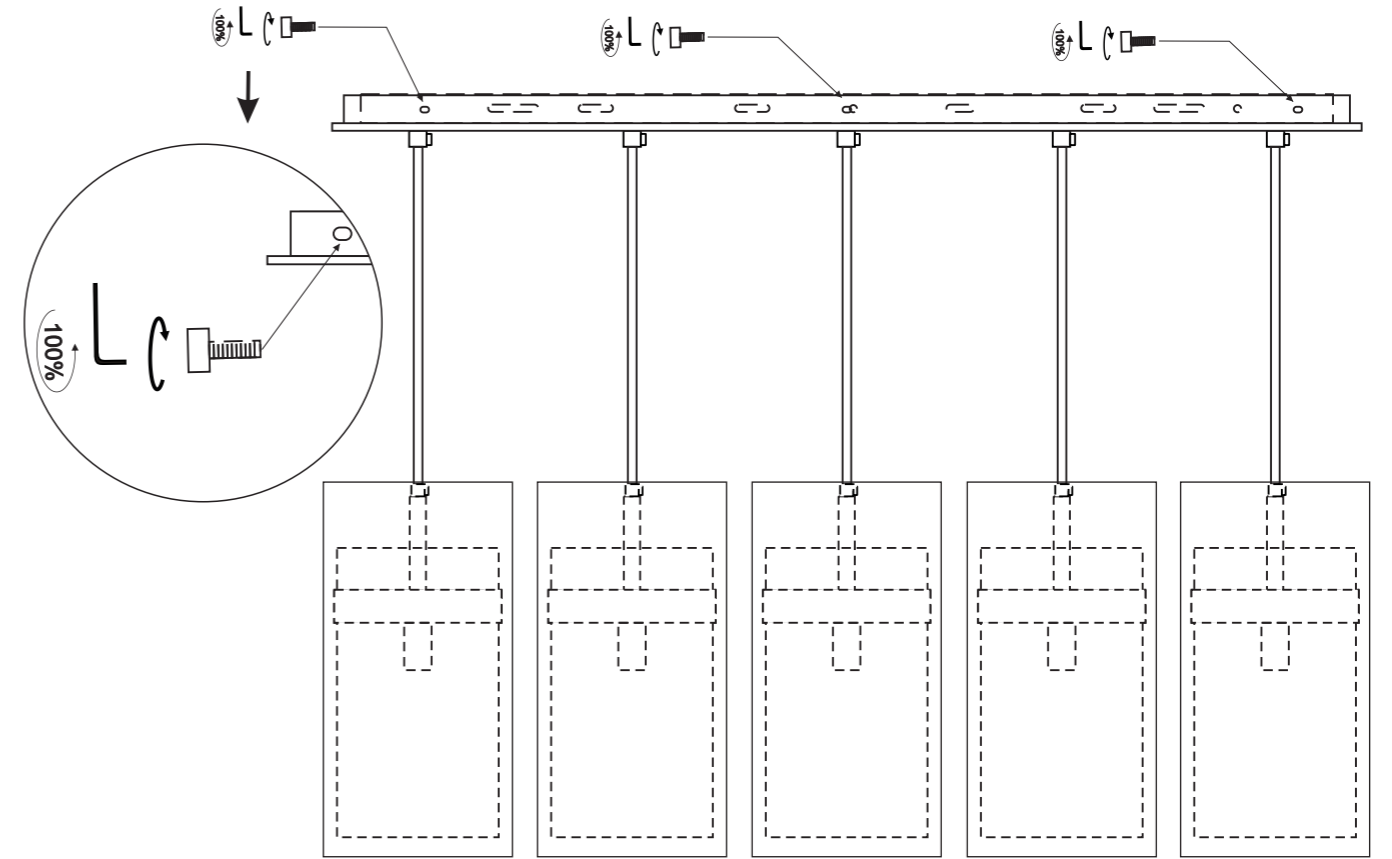

**STEP 6 Adjusting Frame Heights :** Loose the cord grip. Push or pull the cord, through the cord grip as per the height required. Tighten the cord grip as per desired height. After the installation, gently remove the glass mold.

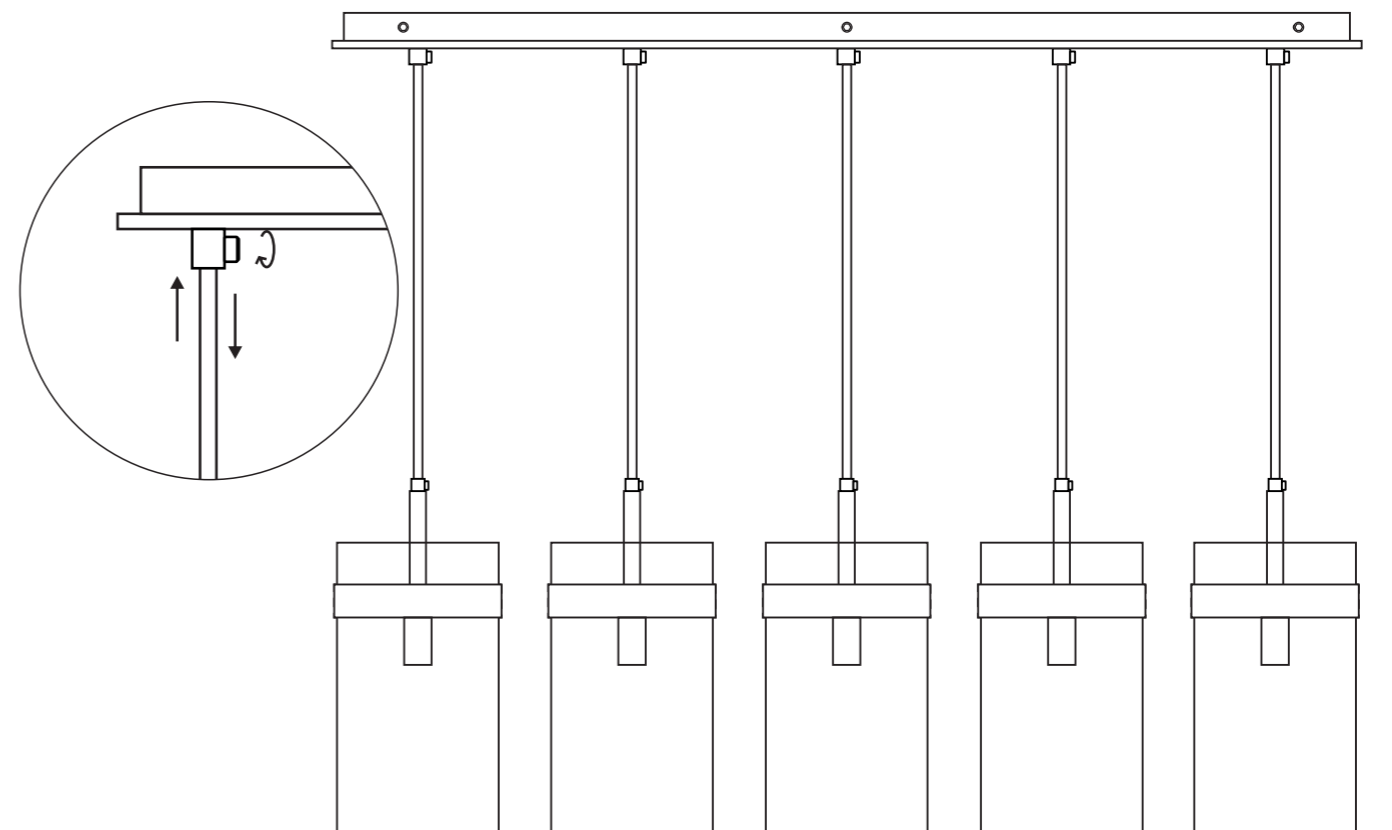

**STEP 7 Assemble the bulb :** Attach bulb to holder.

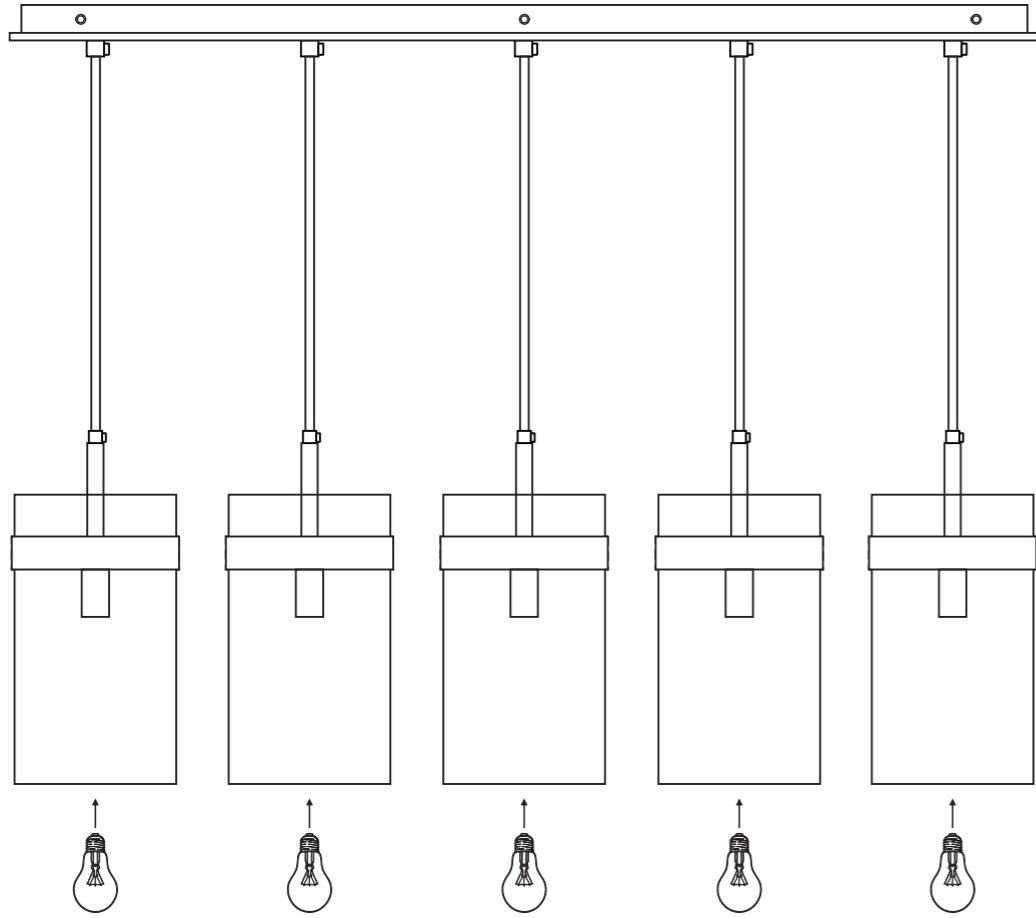

**STEP 8 Restore power to junction box and test fixture.**

**STEP 9 Now your product is ready for use.**

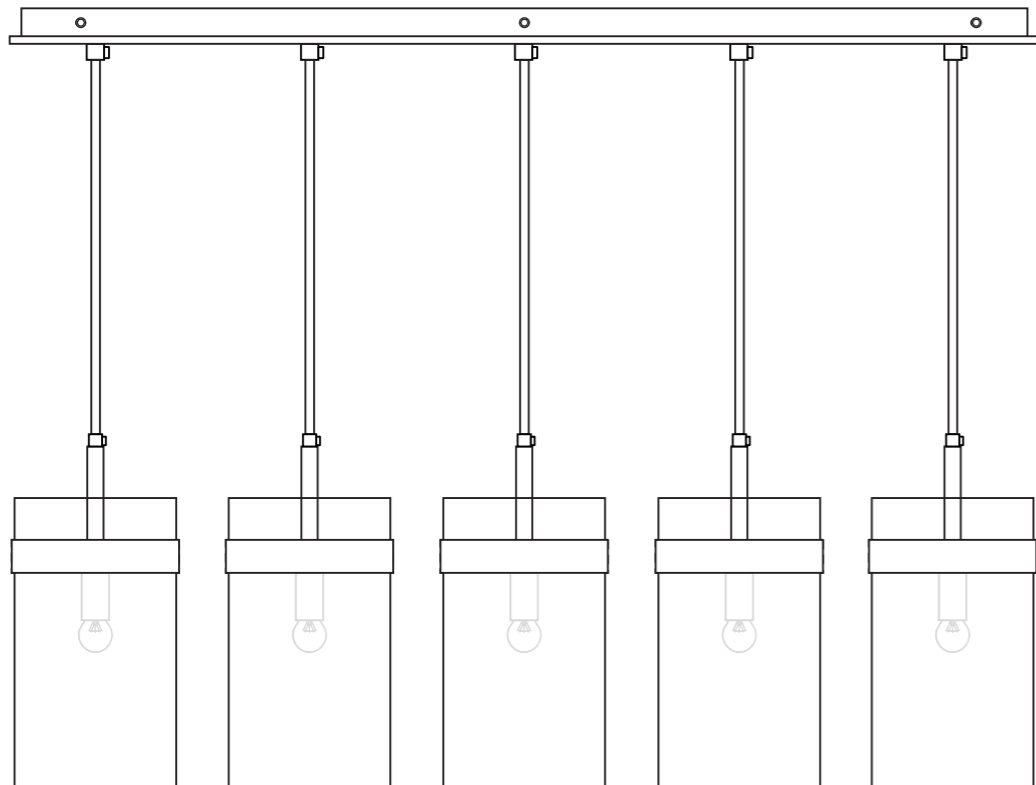

## CLEANING & CARE

- Dust regularly with a dry cloth.
- Do not use abrasive cleaners.
- Do not use chemical cleaners.
- Retain these instructions for reference.

