

Final product image.

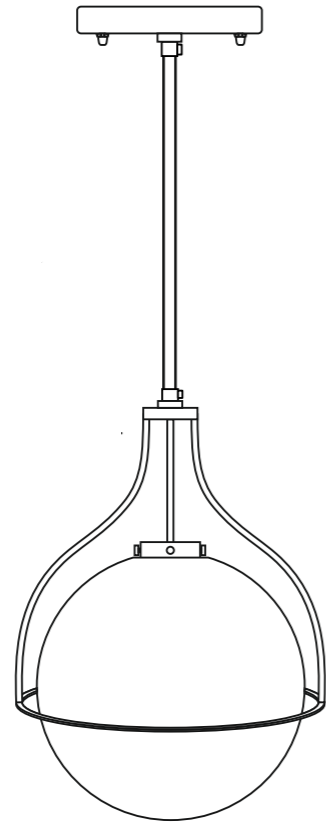

Now your product is ready for use.

CLEANING & CARE

- Dust regularly with a dry cloth.
- Do not use abrasive cleaners.
- Do not use chemical cleaners.
- Retain these instructions for reference.

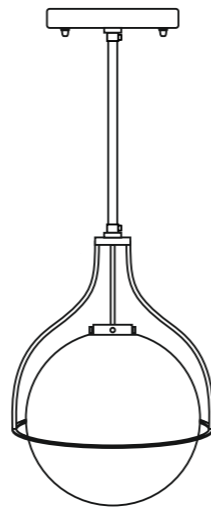

RF
RENOVATION
FACTORY

L040124121151FP

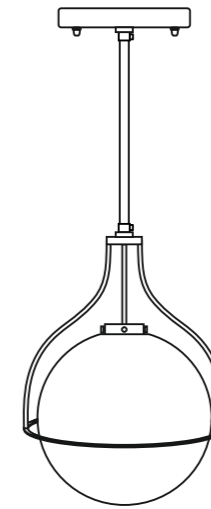

ASSEMBLY INSTRUCTIONS

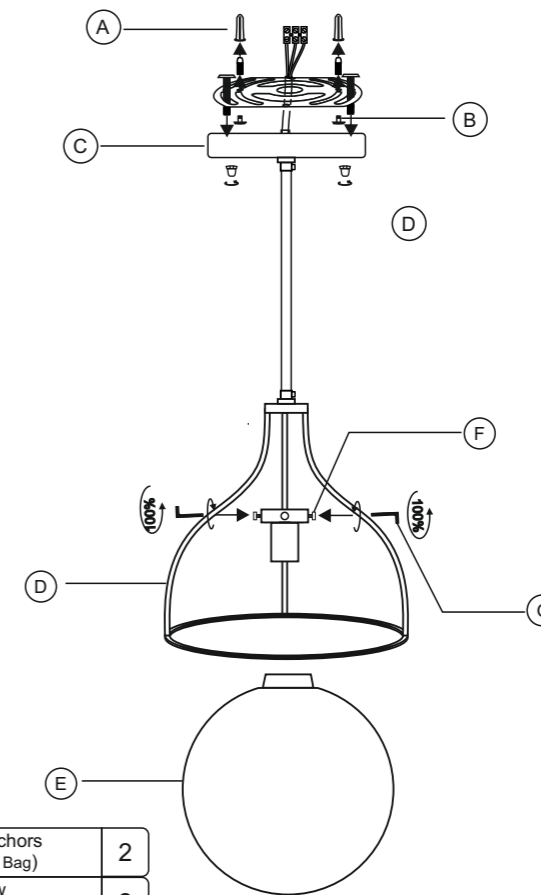

PARTS

A			Screw Anchors (Hardware Bag)	2
B			Screw (Hardware Bag)	2
C			Canopy	1
D			Metal Body	1
E			Sphere Glass	1
F			Screw	3
G			Allen key	1

STEP 1

Get the mounting / installation done by a qualified electrician. Switch off the main electricity before installation. Fix the mounting strap to the plaster ceiling properly with hardware provided.

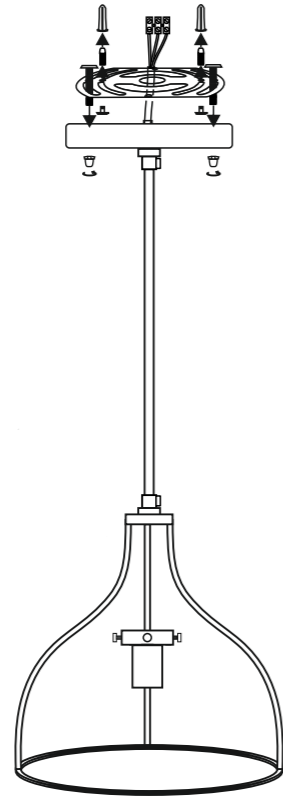

STEP 3

Put the sphere glass in the metal holder frame.

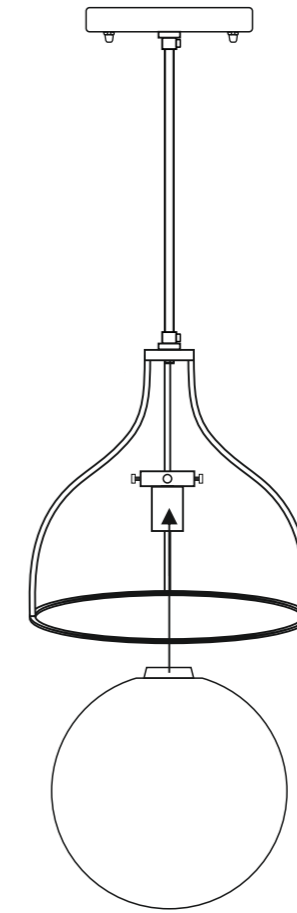

STEP 2

Loose the cord grip for wire length adjustment, insert the wire through the canopy. Attached the brown coloured wire to phase, blue coloured wire to neutral and green yellow coloured wire to earth, and fix the canopy to the mounting strap as shown below, and lock with hardware.

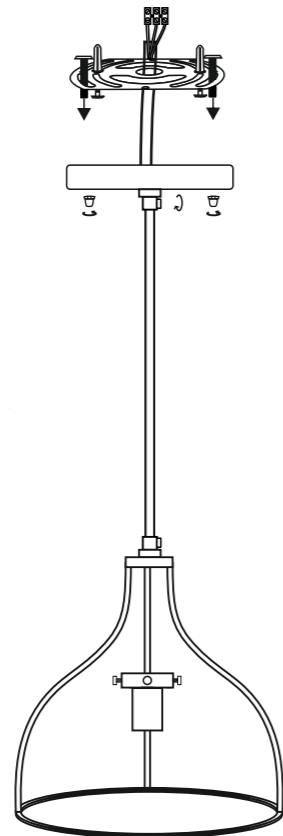

STEP 4

Using short secure all screws tightly by using Allen Key gently.

