

## CLEANING & CARE

- Dust regularly with a dry cloth.
- Do not use abrasive cleaners.
- Do not use chemical cleaners.
- Retain these instructions for reference.

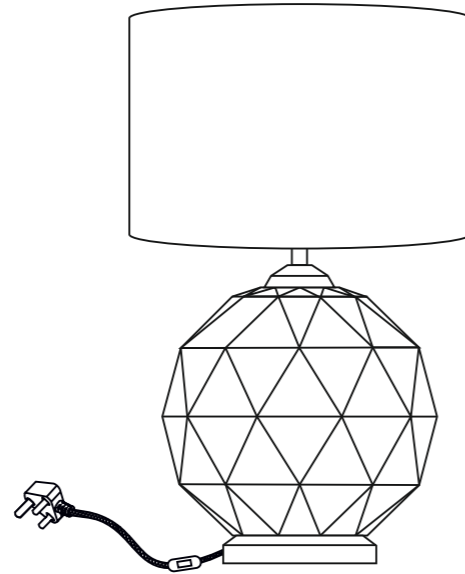

**RF**  
RENOVATION  
FACTORY

L010027026027FK

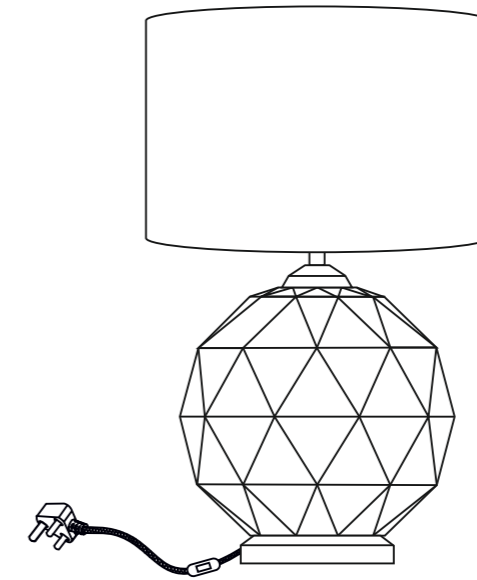

## ASSEMBLY INSTRUCTIONS

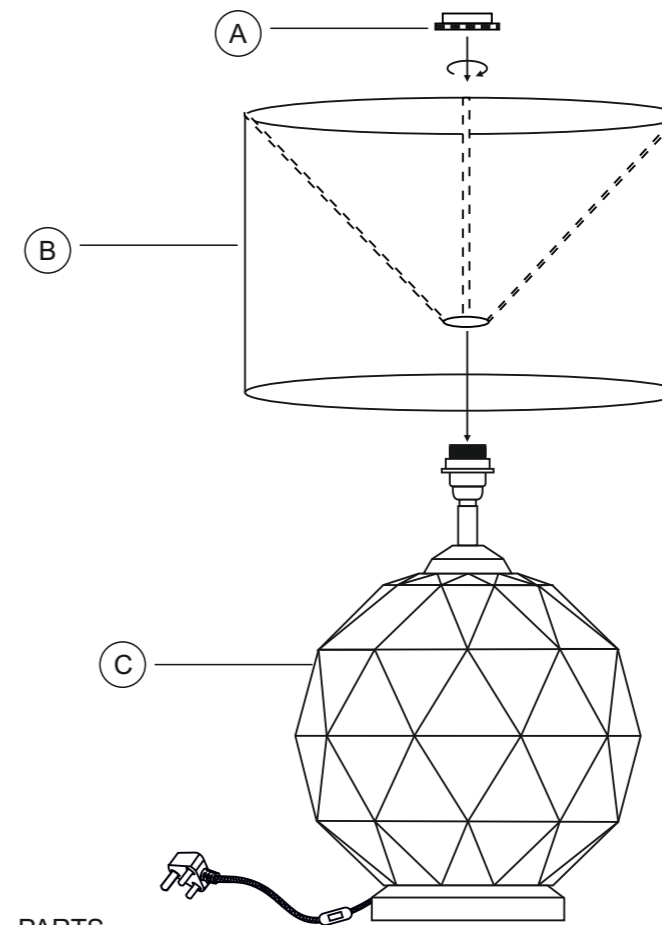

## PARTS

A		Holder Cap	1
B		Shade	1
C		Lamp Body	1

STEP 1

Remove the holder cap from the threaded holder gently.

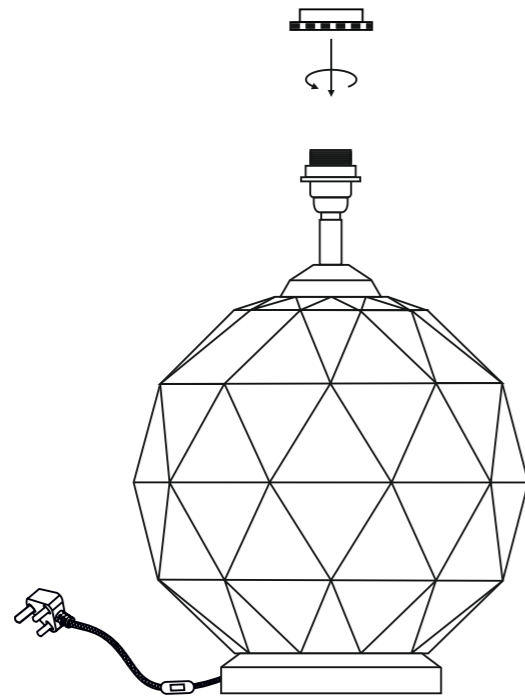

STEP 3

Rotate the holder cap onto the threaded holder gently.

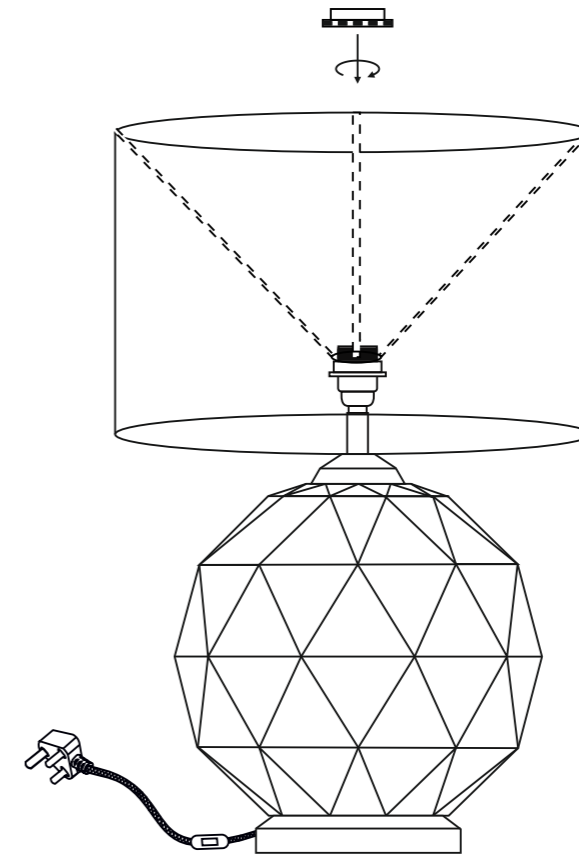

STEP 2

Place the center ring of shade through the threaded end of the holder.

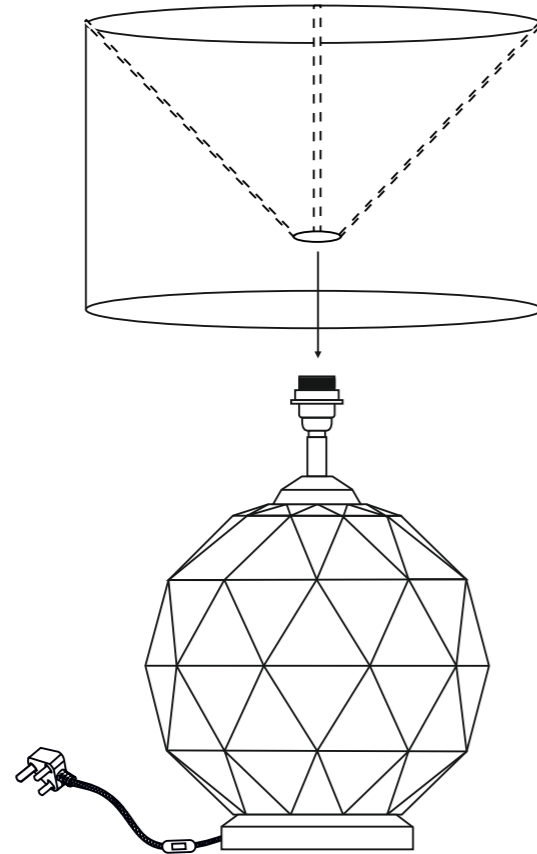

Final product image.

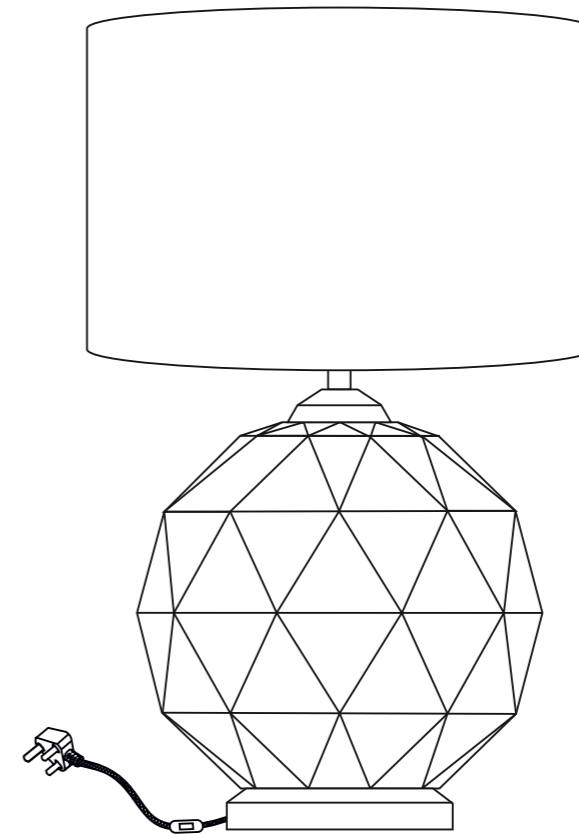

Now your product is ready for use.